

# Non-bendable!

First 6 mm relay with strong mechanical pins

## Omron's G2RV:

- Large plug-in pins
  - LED / Mechanical Flag
  - Transparent Housing
  - Slim Outline
  - Push-in / Accessories
- Excellent Connection
  - Check Operation
  - Check Condition
  - Space Saving
  - Easy Wiring

[www.omron-industrial.com](http://www.omron-industrial.com)  
[www.omron-industrial.com/slimrelay](http://www.omron-industrial.com/slimrelay)

Advanced Industrial Automation

**OMRON**

# Details on the G2RV

## Wiring

The G2RV also provides flexibility for wiring. The Bases in this new Relay Series are available with screw terminals or push-in terminals for wire connection.

Choose the best connection method for the application.

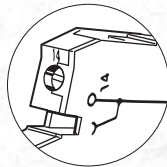
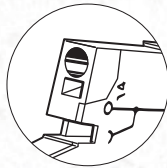

## Terminal Block-type Module

With a width of only 6.1 mm, the G2RV meets essentially any FA application, particularly switching and expansion of equipment and machinery. The G2RV is easily installed even under strict space limitations.

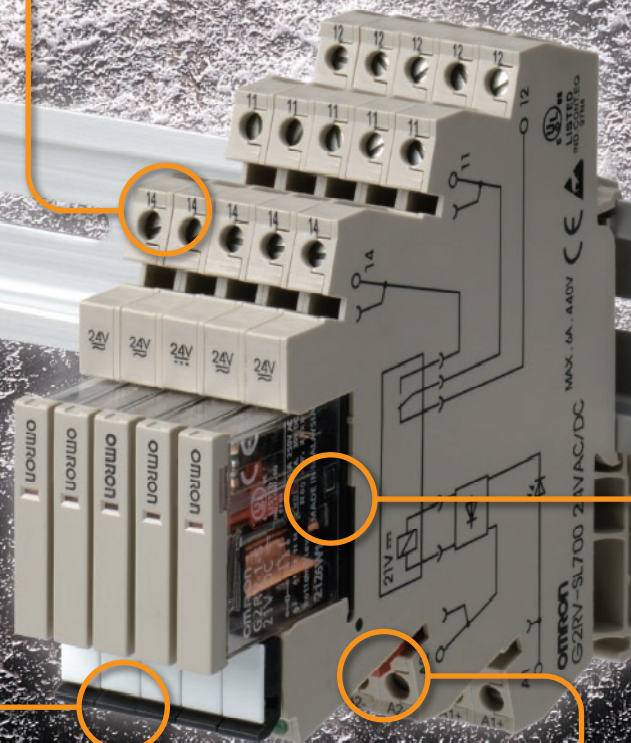

## Stoppers and Levers

Easy-to-use stoppers and levers securely hold the Relays to the Base. They also enable easily removing the Relays from the sockets. The stoppers and levers are also equipped with grooves to attach markers, which can be used to easily identify circuits.

## Crossbars

P2RV Crossbars come in many variations for the number of poles and edge colors. They can be plugged into any of a total of four slots for I/O according to the application.

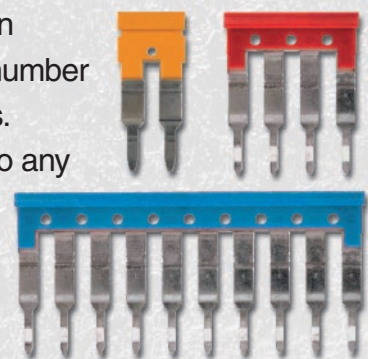

# Slim Relay G2RV

## The World's First Industrial Slim Relay

- Large plug-in terminals for easy connection.
- LED indicator and mechanical flag to check operation.
- Transparent housing enables checking relay condition.
- Slim outline to save space.
- Push-in terminals and accessories for easy wiring.

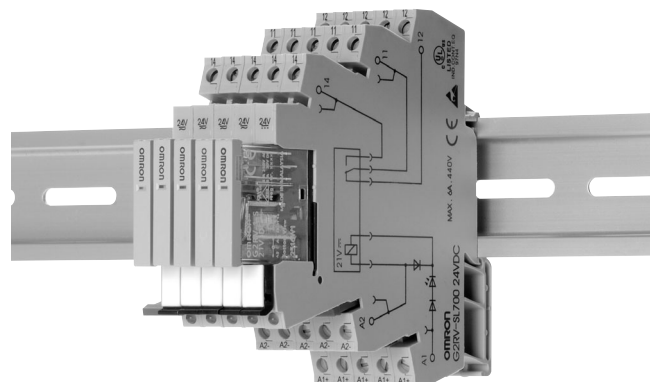

## Model Number Structure

### Model Number Legend

G2RV-SL       -    

1    2    3    4    5

#### 1. Auxiliary Type Designation

SL: Slim relay and socket combination

#### 2. Wire Connection

7: Screw terminals

5: Push-in terminals

#### 3. Relay LED

0: Without LED

**Note:** LED indicator available on Socket.

#### 4. Relay Pushbutton

0: Without pushbutton

#### 5. Input Voltage

## Ordering Information

### List of Models

Classification		Enclosure rating	Input voltage	Type of connection	Contact form
					SPDT
Plug-in terminals	General-purpose	Unsealed	AC/DC	Screw terminals	G2RV-SL700
				Push-in terminals	G2RV-SL500

### Relay and Socket Combinations

Input voltage	Screw terminals	Push-in terminals
12 VDC	G2RV-SL700-12 VDC	G2RV-SL500-12 VDC
24 VDC	G2RV-SL700-24 VDC	G2RV-SL500-24 VDC
24 VAC/DC	G2RV-SL700-24 VAC/DC	G2RV-SL500-24 VAC/DC
48 VAC/DC	G2RV-SL700-48 VAC/DC	G2RV-SL500-48 VAC/DC
110 VAC	G2RV-SL700-110 VAC	G2RV-SL500-110 VAC
230 VAC	G2RV-SL700-230 VAC	G2RV-SL500-230 VAC

# Specifications

## Input Ratings

Rated voltage	Rated current			Operate voltage	Release voltage	Power consumption		Input voltage	
	AC		DC			% of rated voltage	AC (VA) Approx.		DC (mW) Approx.
	50 Hz	60 Hz							
12 VDC	---	---	27.2	80%	10%	---	300 mW	±10%	
24 VDC	---	---	13.3			---	300 mW		
24 VAC/DC	21.1	22.5	13.0			0.5 VA	300 mW		
48 VAC/DC	8.5	9.0	5.2			0.4 VA	250 mW		
110 VAC	7.1	7.5	---			0.8 VA	---		
230 VAC	7.3	7.9	---			1.7 VA	---		

## Contact Ratings

Number of poles	1 pole	
Load	Resistive load (cosφ = 1)	Inductive load (cosφ = 0.4, L/R = 7 ms)
Rated load	6 A at 250 VAC; 6 A at 30 VDC	2.5 A at 250 VAC; 2 A at 30 VDC
Rated carry current	6 A	
Max. switching voltage	440 VAC, 125 VDC	
Max. switching current	6 A	
Max. switching power	1,500 VA 180 W	500 VA 60 W
Failure rate (reference value)	10 mA at 5 VDC	

Note: P level:  $\lambda_{60} = 0.1 \times 10^{-6}/\text{operation}$

## Characteristics

Item	1 pole
Contact material	AgSnIn
Contact resistance	100 mΩ max.
Operate time	20 ms max., DC input: 5 ms, AC/DC input: 5 ms, AC input: 12 ms (typical values)
Release time	40 ms max., DC input: 8 ms, AC/DC input: 25 ms, AC input: 32 ms (typical values)
Max. operating frequency	Mechanical: 18,000 operations/hr Electrical: 1,800 operations/hr (under rated load)
Insulation resistance	1,000 MΩ min. (at 500 VDC)
Dielectric strength	4,000 VAC, 50/60 Hz for 1 min between coil and contacts; 1,000 VAC, 50/60 Hz for 1 min between contacts of same polarity
Vibration resistance	Destruction: 10 to 55 to 10 Hz, 0.50 mm single amplitude (1.0 mm double amplitude) Malfunction: 10 to 55 to 10 Hz, 0.50 mm single amplitude (1.0 mm double amplitude)
Shock resistance	Destruction: 1,000 m/s <sup>2</sup> Malfunction: 200 m/s <sup>2</sup> when energized; 100 m/s <sup>2</sup> when not energized
Endurance	Mechanical: 5,000,000 operations min. Electrical: 70,000 operations min. with NO contact, 50,000 operations min. with NC contact
Ambient temperature	Operating: -40°C to 55°C (with no icing or condensation)
Ambient humidity	Operating: 5% to 85%
Weight	Approx. 35 g
Overvoltage category	III
Pollution degree	2

Note: Values in the above table are the initial values.

## Approved Standard

### UL 508 (File No. E41643)

Contact form	Coil ratings	Contact ratings	Operations
SPDT	12 to 48 VDC 24 to 230 VAC	250 VAC 6 A (Res.) 30 VDC 6 A (Res.) 400 VAC 2 A (Res.)	6,000

### IEC/VDE (EN 61810)

Contact form	Coil ratings	Contact ratings	Operations
1 pole changeover	12, 24 VDC 24, 48 VAC/DC 110, 230 VAC	250 VAC 6 A (Res.) 30 VDC 6 A (Res.) 400 VAC 2 A (Res.)	50,000 50,000 6,000

# Accessories

## ■ PLC Interfaces

### List of Models

Model number	Description	Connection
P2RV-8-O-F	For output use	Flat cable

### Specifications

Input	Rated voltage	30 VAC/VDC max.
	Current capacity	0.5 A per channel 2.0 A total current, power supply terminal
Characteristics	Ambient temperature	Operating: 0 to 55°C Storage: -20 to 85°C
	Overvoltage category	III
	Pollution degree	2

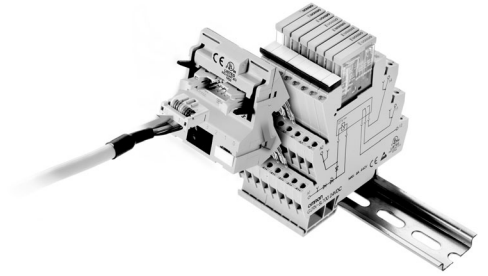

## ■ DeviceNet

### List of Models

I/O type	Internal I/O common	Number of I/O points	I/O connections	Internal circuit power	Rated I/O power supply voltage	Model
Inputs	NPN (+ common)	16	MIL connector	Supplied from communications connector.	24 VDC	DRT2-ID16ML
	PNP (- common)					DRT2-ID16ML-1
Outputs	NPN (- common)	16	MIL connector	Supplied from communications connector.	24 VDC	DRT2-OD16ML
	PNP (+ common)					DRT2-OD16ML-1



### Specifications

#### Models with 16-input/16-output Connector Models with 16-input Connector

Item	DRT2-ID16ML DRT2-ID16MLX	DRT2-ID16ML-1 DRT2-ID16MLX-1
Internal I/O common	NPN	PNP
I/O points	16 inputs	
ON voltage	17 VDC min. (between each input terminal and V terminal)	17 VDC min. (between each input terminal and G terminal)
OFF voltage	5 VDC max. (between each input terminal and V terminal)	5 VDC max. (between each input terminal and G terminal)
OFF current	1.0 mA max.	
Input current	6.0 mA max./point (at 24 VDC) 3.0 mA max./point (at 17 VDC)	
ON delay time	1.5 ms max.	
OFF delay time	1.5 ms max.	
Maximum number of simultaneously ON inputs	16	
Circuits per common	16/common	

#### Models with 16-input/16-output Connector Models with 16-output Connector

Item	DRT2-OD16ML DRT2-OD16MLX	DRT2-OD16ML-1 DRT2-OD16MLX-1
Internal I/O common	NPN	PNP
I/O points	16 outputs	
Rated output current	0.3 A/point, 2 A/ common (See note 1.)	
Residual voltage	1.2 V max. (0.3 A DC between each output terminal and G terminal)	1.2 V max. (0.3 A DC between each output terminal and V terminal)
Leakage current	0.1 mA max.	
ON delay time	0.5 ms max.	
OFF delay time	1.5 ms max.	
Circuits per common	16/common	

**Note:** Do not allow the total external load current to exceed 2 A.  
Do not allow the current for the V terminal or G terminal to exceed 1 A.

## ■ Single Relays for Maintenance

### Model Number Legend

G2RV-□ - □ □ □ - □ - □  
 1 2 3 4 5 6

**1. Number of Poles**

1: 1 pole

**2. Terminals**

S: Plug-In

**3. Relay LED**

Blank: Without LED

**4. Relay Pushbutton**

Blank: Without pushbutton

**5. Contact Material**

Blank: AgSnIn

**6. Rated Coil Voltage**

11 VDC, 21 VDC, and 48 VDC

### List of Models

Model number	Replacement for
G2RV-1-S DC11	G2RV-SL7□□/5□□ DC12
G2RV-1-S DC21	G2RV-SL7□□/5□□ DC24
	G2RV-SL7□□/5□□ AC/DC24
G2RV-1-S DC48	G2RV-SL7□□/5□□ AC/DC48
	G2RV-SL7□□/5□□ AC110
	G2RV-SL7□□/5□□ AC230

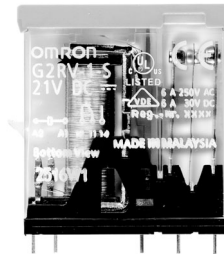

## ■ Crossbars

### Model Number Legend

P2RVM - □ □  
 1 2

**1. Number of Poles**

020: 2 poles

030: 3 poles

040: 4 poles

100: 10 poles

200: 20 poles

**2. Color**

R: Red

S: Blue

B: Black

Model number	Poles	Color
P2RVM-020□	2	Red (R)
P2RVM-030□	3	Blue (S)
P2RVM-040□	4	Black (B)
P2RVM-100□	10	
P2RVM-200□	20	

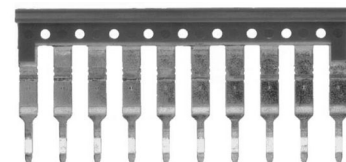
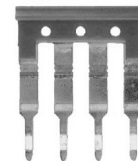

## ■ Plastic Labels for G2RV Sockets

Model number	Quantity	Color
R99-15 for G2RV	5 sheets × 120 labels = 600 labels (minimum order)	White

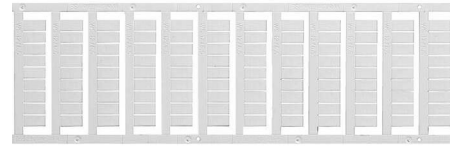

## ■ Labels (Stickers) for G2RV Sockets

Model number	Quantity	Color
R99-16 for G2RV	10 sheets × 484 labels = 4,840 labels (minimum order)	White

## ■ Separating Plates

Model number	Quantity	Description
P2RV-S	50 plates (minimum order)	Provides isolation between adjacent relays to achieve 440-V isolation.

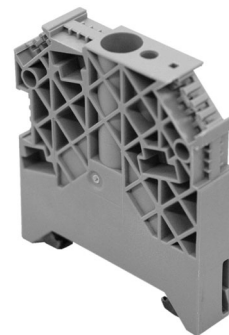

## Connections

### ■ PLC Interfaces

P2RVC-8-O-F

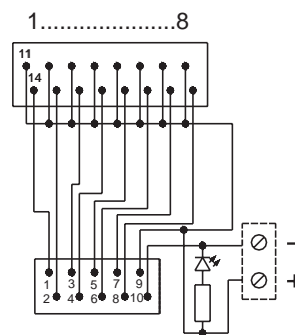
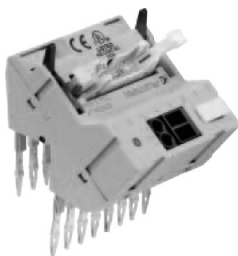

# Dimensions

Note: All units are in millimeters unless otherwise indicated.

## Complete Unit

### G2RV-SL700

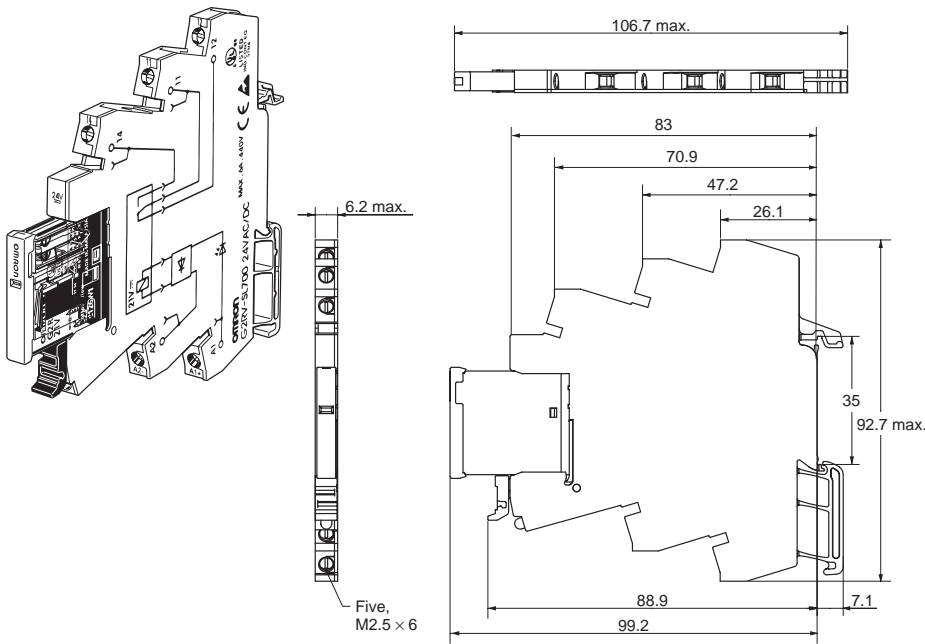

### Input circuit

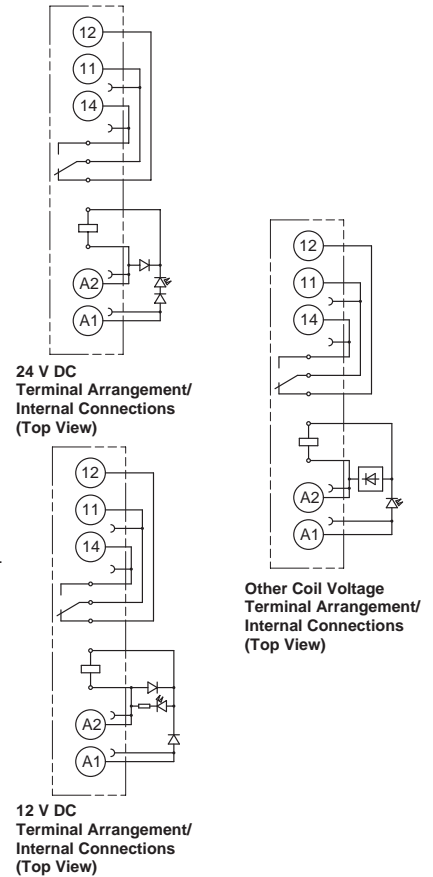



G2RV-SL500

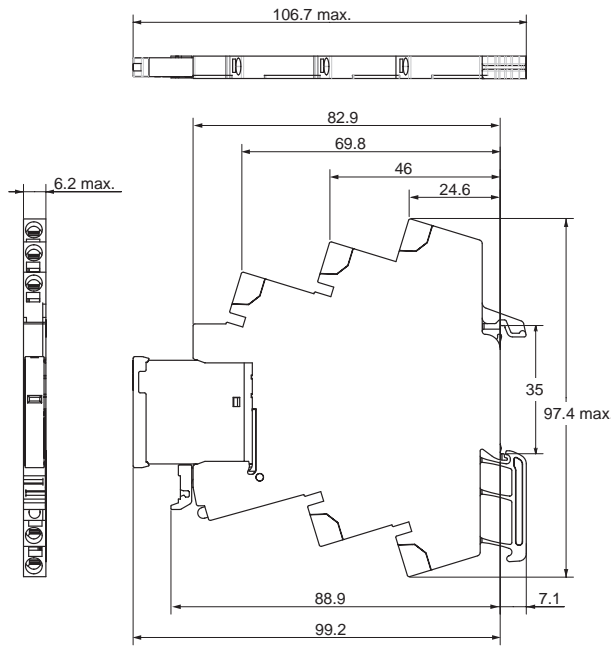
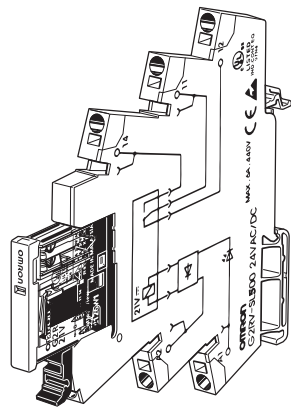

Input circuit

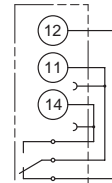

24 V DC  
Terminal Arrangement/  
Internal Connections  
(Top View)

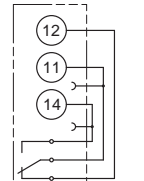

Other Coil Voltage  
Terminal Arrangement/  
Internal Connections  
(Top View)

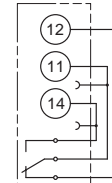

12 V DC  
Terminal Arrangement/  
Internal Connections

Single Relay

G2RV-1-S

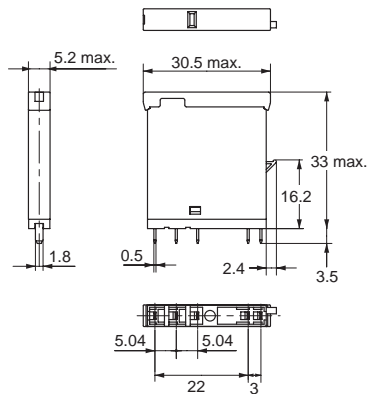
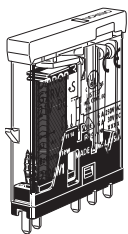

Input circuit

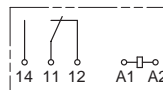

Terminal Arrangement/  
Internal Connections  
(Bottom View)

# Installation

## ■ Tools

A flat-blade screwdriver should be used to mount the cables for G2RV-SL-500-series Relays when using standard wire without ferrules.

### Applicable Screwdriver

- Flat-blade, Parallel-tip, 2.5 mm diameter (3.0 mm max.)

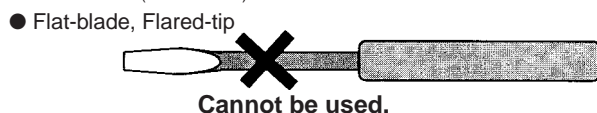
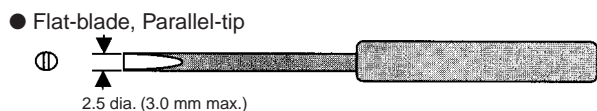

Examples: FACOM      AEF.2.5×75E      (AEF. 3×75E)  
 VESSEL      No. 9900-(-)2.5×75      (No. 9900-(-)3×100)  
 WIHA      260/2.5×40      (260/3×50)  
 WEIDMULLER      SD 0.4×2.5×7.5      (SD 0.5×3.0×80)

\*Chamfering the tip of the driver improves insertion when used as an exclusive tool.

## ■ Applicable Wires

### Applicable Wire Sizes

#### G2RV-SL700 Series

Property	Requirements
Cross-section with clamping yoke technology	0.5 to 2.5 mm <sup>2</sup> : stranded/solid (without ferrules) 0.5 to 2.5 mm <sup>2</sup> : stranded wires with ferrules with plastic collar 0.5 to 2.5 mm <sup>2</sup> : stranded wires with ferrules without plastic collar 4 mm <sup>2</sup> : Solid Stripping length: 7 mm

#### G2RV-SL500 Series

Property	Requirements
Cross-section with push-in technology	0.5 to 2.5 mm <sup>2</sup> : stranded/solid (without ferrules) 0.5 to 1.5 mm <sup>2</sup> : stranded wires with ferrules with plastic collar 0.5 to 2.5 mm <sup>2</sup> : stranded wires with ferrules without plastic collar 4 mm <sup>2</sup> : Solid Stripping length: 12 mm

Use wires of the applicable sizes specified in the above table. The length of the exposed conductor should be 7 mm for a G2RV-SL700 series Relay, 12 mm for a G2RV-SL500 series Relay.

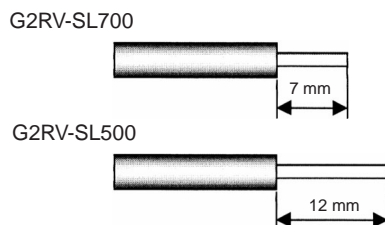
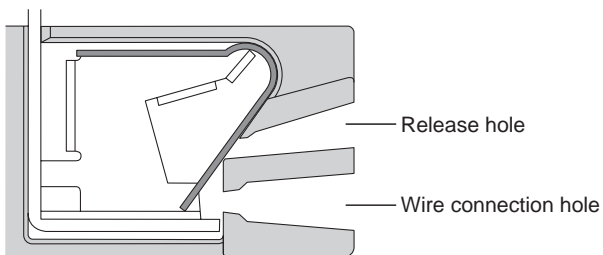
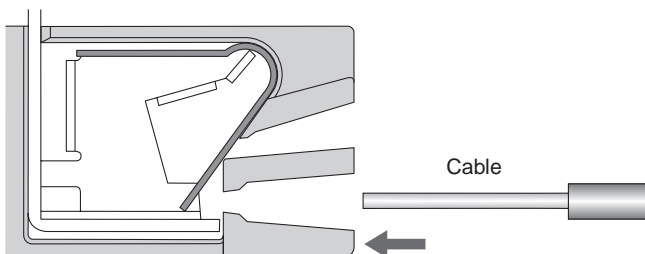

Fig. 1 Exposed Conductor Length

## ■ Wiring Procedure for G2RV-SL500 Series



### ● Wiring (for Stranded Wires with Ferrules or Solid Wire)



Insert the exposed conductor into the connection hole.

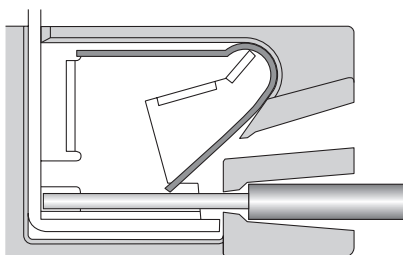

No other tools are required.

Use the above procedure for stranded wires without ferrules, but add the following step to the beginning of the procedure.

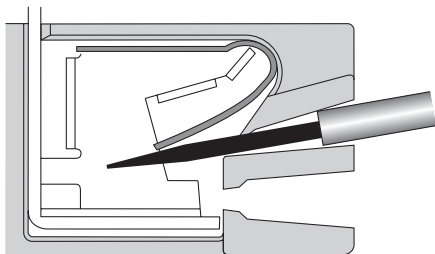

### ● Remove

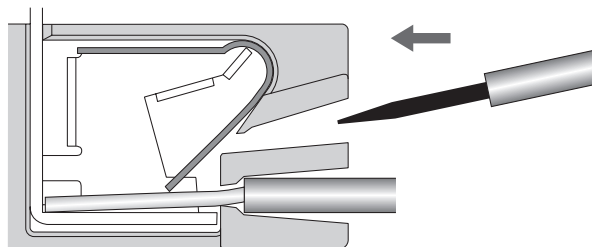

Insert the specified screwdriver into the release hole.

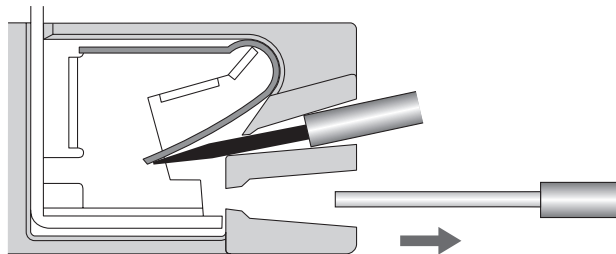

Remove wire.

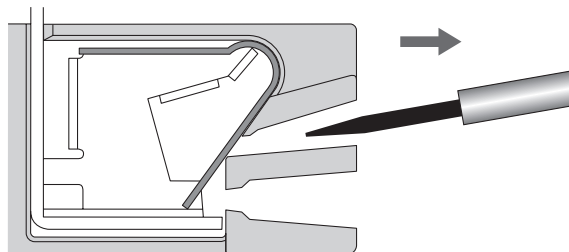

Remove screwdriver.

**Note:** Remove the screwdriver all the way.

# Precautions

## Precautions for Connection

- Do not move the screwdriver up, down, or from side to side while it is inserted in the hole. Doing so may cause damage to internal components (e.g., deformation of the clamp spring or cracks in the housing) or cause deterioration of insulation.
- Do not insert the screwdriver at an angle. Doing so may break the side of socket and result in a short-circuit.

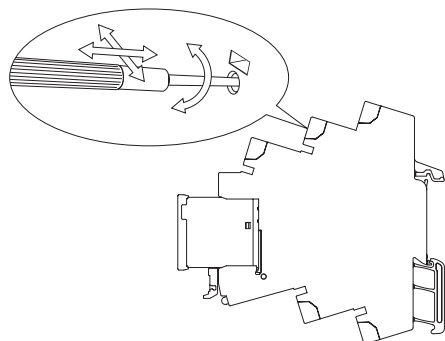

- Do not insert two or more wires in the hole. Wires may come in contact with the spring causing a temperature rise or be subject to sparks.

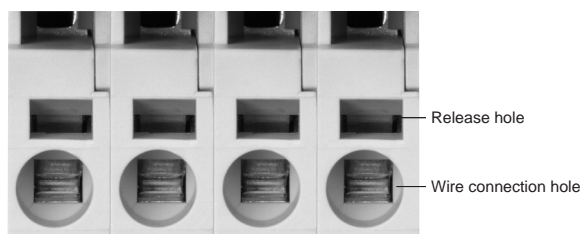

- Insert the screwdriver along the hole wall as shown below.

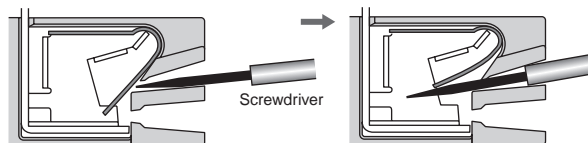

- If lubricating liquid, such as oil, is present on the tip of screwdriver, the screwdriver may fall out resulting in injury to the operator.
- Insert the screwdriver into the bottom of the hole. It may not be possible to connect cables properly if the screwdriver is inserted incorrectly.

## General Precautions

- Do not use the product if it has been dropped on the ground. Dropping the product may adversely affect performance.
- Confirm that the socket is securely attached to the mounting track before wiring. If the socket is mounted insecurely it may fall and injure the operator.
- Ensure that the socket is not charged during wiring and maintenance. Not doing so may result in electric shock.
- Do not pour water or cleansing agents on the product. Doing so may result in electric shock.
- Do not use the socket in locations subject to solvents or alkaline chemicals.
- Do not use the socket in locations subject to ultraviolet light (e.g., direct sunlight). Doing so may result in markings fading, rust, corrosion, or resin deterioration.
- Do not dispose of the product in fire.

## Removing from Mounting Rail

To remove the socket from the mounting rail, insert the tip of screwdriver in the fixture rail, and move it in the direction shown below.

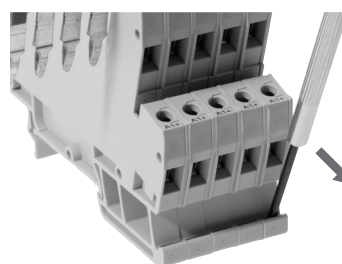

**ALL DIMENSIONS SHOWN ARE IN MILLIMETERS.**

To convert millimeters into inches, multiply by 0.03937. To convert grams into ounces, multiply by 0.03527.

Cat. No. J163-E1-01 **In the interest of product improvement, specifications are subject to change without notice.**

## OMRON RELAY & DEVICES Corporation

Power Relay Division

Marketing Department

1110, Sugi, Yamaga-city, Kumamoto-Pref., 861-0596 Japan

Tel: (81)968-44-4149/Fax: (81)968-44-4107



Компания «ЭлектроПласт» предлагает заключение долгосрочных отношений при поставках импортных электронных компонентов на взаимовыгодных условиях!

Наши преимущества:

- Оперативные поставки широкого спектра электронных компонентов отечественного и импортного производства напрямую от производителей и с крупнейших мировых складов;
- Поставка более 17-ти миллионов наименований электронных компонентов;
- Поставка сложных, дефицитных, либо снятых с производства позиций;
- Оперативные сроки поставки под заказ (от 5 рабочих дней);
- Экспресс доставка в любую точку России;
- Техническая поддержка проекта, помощь в подборе аналогов, поставка прототипов;
- Система менеджмента качества сертифицирована по Международному стандарту ISO 9001;
- Лицензия ФСБ на осуществление работ с использованием сведений, составляющих государственную тайну;
- Поставка специализированных компонентов (Xilinx, Altera, Analog Devices, Intersil, Interpoint, Microsemi, Aeroflex, Peregrine, Syfer, Eurofarad, Texas Instrument, Miteq, Cobham, E2V, MA-COM, Hittite, Mini-Circuits, General Dynamics и др.);

Помимо этого, одним из направлений компании «ЭлектроПласт» является направление «Источники питания». Мы предлагаем Вам помощь Конструкторского отдела:

- Подбор оптимального решения, техническое обоснование при выборе компонента;
- Подбор аналогов;
- Консультации по применению компонента;
- Поставка образцов и прототипов;
- Техническая поддержка проекта;
- Защита от снятия компонента с производства.



#### Как с нами связаться

**Телефон:** 8 (812) 309 58 32 (многоканальный)

**Факс:** 8 (812) 320-02-42

**Электронная почта:** [org@eplast1.ru](mailto:org@eplast1.ru)

**Адрес:** 198099, г. Санкт-Петербург, ул. Калинина, дом 2, корпус 4, литера А.