

# Model 315

## HFF HCMOS VCXO

### Features

- Ceramic Surface Mount Package
- Ultra-Low Phase Jitter Performance
- High Frequency Fundamental Crystal Design
- Frequency Range 100 – 170MHz \*
- +3.3V Operation
- Output Enable Standard
- Tape and Reel Packaging, EIA-418



Part Dimensions:  
5.0 × 3.2 × 1.2mm • 62.28mg

### Applications

- Small Cells
- Wireless Communication
- Broadband Access
- SONET/SDH/DWDM
- Base Stations
- Ethernet/GbE/SyncE
- Digital Video
- Test and Measurement

Standard Frequencies	
- 100.00MHz	- 155.52MHz
- 122.88MHz	- 156.25MHz
- 125.00MHz	- 166.00MHz
- 153.60MHz	

\* Check with factory for availability.

### Description

CTS Model 315 is a low cost, small size, high performance VCXO. Employing the latest IC technology, coupled with a high frequency fundamental crystal, M315 has excellent stability and low jitter/phase noise performance.

### Ordering Information

Model	Supply Voltage	Absolute Pull Range	Frequency Stability	Temperature Range	Frequency Code [MHz]	Packaging
315	L	B	3	I	XXX or XXXX	T
	Code Voltage		Code Stability		Code Frequency	
	L +3.3V ±5%		3 ±50ppm 5 ±25ppm 6 ±20ppm <sup>1</sup>		Product Frequency Code <sup>2</sup>	
		Code APR		Code Temp. Range		Code Packing
		B ±50ppm		C -20°C to +70°C I -40°C to +85°C		T 1k pcs./reel

Notes:

- 1] Only available with "C" temperature range.
- 2] Refer to document 016-1454-0, Frequency Code Tables.  
3-digits for frequencies <100MHz, 4-digits for frequencies 100MHz or greater.

**Not all performance combinations and frequencies may be available.  
Contact your local CTS Representative or CTS Customer Service for availability.**



## Electrical Specifications

### Operating Conditions

PARAMETER	SYMBOL	CONDITIONS	MIN	TYP	MAX	UNIT
Maximum Supply Voltage	$V_{CC}$	-	-0.5	-	5.0	V
Maximum Control Voltage	$V_C$	-	-0.5	-	$V_{CC}$	V
Supply Voltage	$V_{CC}$	$\pm 5\%$	3.14	3.3	3.47	V
Supply Current	$I_{CC}$	Typical @ $C_L = 15$ pF, $T_A = +25^\circ\text{C}$	-	20	30	mA
Output Load	$C_L$	-	-	-	15	pF
Operating Temperature	$T_A$	-	-20 -40	+25	+70 +85	$^\circ\text{C}$
Storage Temperature	$T_{STG}$	-	-40	-	+100	$^\circ\text{C}$

### Frequency Stability

PARAMETER	SYMBOL	CONDITIONS	MIN	TYP	MAX	UNIT
Frequency Range	$f_o$	-		100 - 170		MHz
Frequency Stability [Note 1]	$\Delta f/f_o$	$\pm 20$ ppm stability, $-20^\circ\text{C}$ to $+70^\circ\text{C}$ only		20, 25 or 50		$\pm$ ppm
Absolute Pull Range [Note 2]	APR	-	50	-	-	$\pm$ ppm
Aging	$\Delta f/f_{25}$	First Year @ $+25^\circ\text{C}$ , nominal $V_{CC}$ and $V_C$	-3	-	3	ppm

1.] Inclusive of initial tolerance at time of shipment, changes in supply voltage, load, temperature and 1st year aging.

2.] Minimum guaranteed frequency shift from  $f_o$  over variations in temperature, aging, power supply and load.

### Output Parameters

PARAMETER	SYMBOL	CONDITIONS	MIN	TYP	MAX	UNIT
Output Type	-	-		HCMOS		-
Output Voltage Levels	$V_{OH}$ $V_{OL}$	Logic '1' Level, CMOS Load Logic '0' Level, CMOS Load	$0.9V_{CC}$ -	- -	- $0.1V_{CC}$	V
Output Duty Cycle	SYM	@ 50% Level	45	-	55	%
Rise and Fall Time	$T_R, T_F$	@ 20%/80% Levels	-	1.5	3.0	ns
Start Up Time	$T_S$	Application of $V_{CC}$	-	-	5	ms
<b>Enable Function</b>						
Enable Input Voltage	$V_{IH}$	Pin 2 Logic '1', Output Enabled	$0.7V_{CC}$	-	-	V
Disable Input Voltage	$V_{IL}$	Pin 2 Logic '0', Output Standby	-	-	$0.3V_{CC}$	V
Standby Current	$I_{STB}$	Pin 2 Logic '0', Output Standby	-	-	10	$\mu\text{A}$
Enable Time	$T_{PLZ}$	Pin 2 Logic '1'	-	-	2	ms
Phase Jitter, RMS	$t_{jrms}$	Bandwidth 12 kHz - 20 MHz	-	50	500	fs
Phase Noise	-	See Typical Plots	-	-	-	-

### Enable Truth Table

Pin 2	Pin 4
Logic '1'	Output
Open	Output
Logic '0'	High Imp.

## Electrical Specifications

### Control Voltage

PARAMETER	SYMBOL	CONDITIONS	MIN	TYP	MAX	UNIT
Control Voltage	$V_C$	-	0.30	1.65	3.00	V
Frequency Deviation	$\Delta f/f_0$	$V_C = 0.0V$		-155 to -75		ppm
		$V_C = 3.3V$		75 to 155		
Linearity	L	Best Straight Line Fit	-	5	10	%
Gain Transfer	$K_V$	Pull Sensitivity; @ +1.65V, +25°C	-	65	-	ppm/V
Input Impedance	$Z_{V_C}$	-	100	-	-	kOhms
Modulation Roll-off	-	@ -3dB	20	-	-	kHz
Transfer Function	-	-		Positive		-

### Test Circuit

HCMOS



### Output Waveform

HCMOS



## Electrical Specifications

### Performance Data

#### Frequency Deviation – Over Temperature [typical]

122.88MHz,  $V_{CC} = 3.3V$ ,  $V_C = 1.65V$

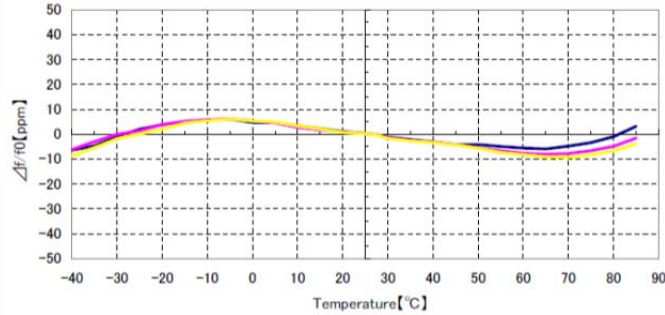

156.25MHz,  $V_{CC} = 3.3V$ ,  $V_C = 1.65V$



#### Frequency Deviation – Pulling Range [typical]

122.88MHz,  $V_{CC} = 3.3V$ ,  $T_A = +25^\circ V$

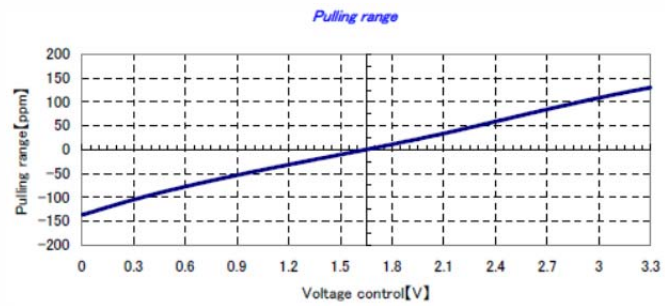

156.25MHz,  $V_{CC} = 3.3V$ ,  $T_A = +25^\circ V$

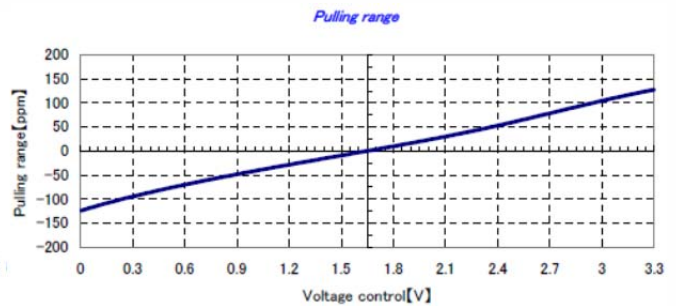

#### Frequency Deviation – Gain Transfer [typical]

122.88MHz,  $V_{CC} = 3.3V$ ,  $T_A = +25^\circ V$

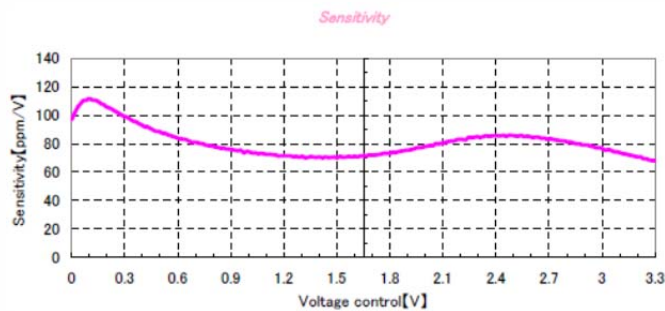

156.25MHz,  $V_{CC} = 3.3V$ ,  $T_A = +25^\circ V$

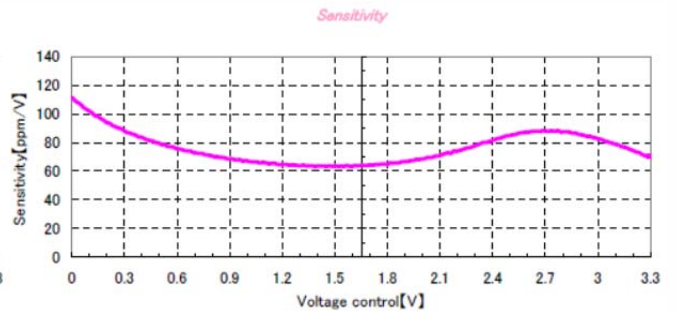

### Electrical Specifications

#### Performance Data

##### Phase Noise [typical]

122.88MHz,  $V_{CC} = 3.3V$ ,  $V_C = 1.65V$ ,  $T_A = +25^\circ C$



156.25MHz,  $V_{CC} = 3.3V$ ,  $V_C = 1.65V$ ,  $T_A = +25^\circ C$



## Mechanical Specifications

### Package Drawing



### Marking Information

- \*\* - Manufacturing Site Code.
- D – Date Code. See Table I for codes.
- ST – Frequency Stability/Temperature Code. [Refer to Ordering Information]
- V – Voltage Code. L = 3.3V
- xxxx – Frequency Code. 4-digits required for frequencies 100MHz and above. [See document 016-1454-0, Frequency Code Tables.]

### Recommended Pad Layout



### Notes

- Termination pads (e4). Barrier-plating is nickel [Ni] with gold [Au] flash plate.
- Reflow conditions per JEDEC J-STD-020; +260°C maximum, 20 seconds.
- MSL = 1.

### Pin Assignments

Pin	Symbol	Function
1	V <sub>C</sub>	Control Voltage
2	EOH	Enable
3	GND	Circuit & Package
4	Output	RF Output
5	N.C.	No Connect
6	V <sub>CC</sub>	Supply Voltage

Table I - Date Code

YEAR		MONTH					JAN	FEB	MAR	APR	MAY	JUN	JUL	AUG	SEP	OCT	NOV	DEC
2001	2005	2009	2013	2017		A	B	C	D	E	F	G	H	J	K	L	M	
2002	2006	2010	2014	2018		N	P	Q	R	S	T	U	V	W	X	Y	Z	
2003	2007	2011	2015	2019		a	b	c	d	e	f	g	h	j	k	l	m	
2004	2008	2012	2016	2020		n	p	q	r	s	t	u	v	w	x	y	z	

### Packaging - Tape and Reel

#### Tape Drawing



#### Reel Drawing



#### Notes

1. Device quantity is 1k pieces maximum per 180mm reel.
2. Complete CTS part number, frequency value and date code information must appear on reel and carton labels.



Компания «ЭлектроПласт» предлагает заключение долгосрочных отношений при поставках импортных электронных компонентов на взаимовыгодных условиях!

Наши преимущества:

- Оперативные поставки широкого спектра электронных компонентов отечественного и импортного производства напрямую от производителей и с крупнейших мировых складов;
- Поставка более 17-ти миллионов наименований электронных компонентов;
- Поставка сложных, дефицитных, либо снятых с производства позиций;
- Оперативные сроки поставки под заказ (от 5 рабочих дней);
- Экспресс доставка в любую точку России;
- Техническая поддержка проекта, помощь в подборе аналогов, поставка прототипов;
- Система менеджмента качества сертифицирована по Международному стандарту ISO 9001;
- Лицензия ФСБ на осуществление работ с использованием сведений, составляющих государственную тайну;
- Поставка специализированных компонентов (Xilinx, Altera, Analog Devices, Intersil, Interpoint, Microsemi, Aeroflex, Peregrine, Syfer, Eurofarad, Texas Instrument, Miteq, Cobham, E2V, MA-COM, Hittite, Mini-Circuits, General Dynamics и др.);

Помимо этого, одним из направлений компании «ЭлектроПласт» является направление «Источники питания». Мы предлагаем Вам помощь Конструкторского отдела:

- Подбор оптимального решения, техническое обоснование при выборе компонента;
- Подбор аналогов;
- Консультации по применению компонента;
- Поставка образцов и прототипов;
- Техническая поддержка проекта;
- Защита от снятия компонента с производства.



#### Как с нами связаться

**Телефон:** 8 (812) 309 58 32 (многоканальный)

**Факс:** 8 (812) 320-02-42

**Электронная почта:** [org@eplast1.ru](mailto:org@eplast1.ru)

**Адрес:** 198099, г. Санкт-Петербург, ул. Калинина, дом 2, корпус 4, литера А.