

Thin-Film Low Pass Filter



LP0402N Series Harmonic Lead-Free LGA Termination

RFAP TECHNOLOGY

The LP0402N Series Harmonic Low Pass Filter is based on the proprietary RFAP Thin-Film multilayer technology. The technology provides a miniature part with excellent high frequency performance and rugged construction for reliable automatic assembly.

The RFAP Harmonic Low Pass Filter is offered in a variety of frequency bands compatible with various types of high frequency wireless systems.

APPLICATIONS

- Wireless communications
- Wireless LAN's
- GPS
- WiMAX

LAND GRID ARRAY ADVANTAGES

- Inherent Low Profile
- Self Alignment during Reflow
- Excellent Solderability
- Low Parasitics
- Better Heat Dissipation

HOW TO ORDER

LP
T
Style

0402
T
Size

N
T
Type

XXXX
T
Frequency
MHz

X
T
Sub-Type

N
T
Termination
LGA
Lead Free

TR
T
Taped & Reeled

QUALITY INSPECTION

Finished parts are 100% tested for electrical parameters and visual characteristics. Each production lot is evaluated on a sample basis for:

- Static Humidity: 85°C, 85% RH, 160 hours
- Endurance: 125°C, IR, 4 hours

TERMINATION

Nickel/Lead-Free solder coating compatible with automatic soldering technologies: reflow, wave soldering, vapor phase and manual.



Thin-Film Low Pass Filter



LP0402N Series Harmonic Lead-Free LGA Termination

DIMENSIONS: millimeters (inches) (Bottom View)

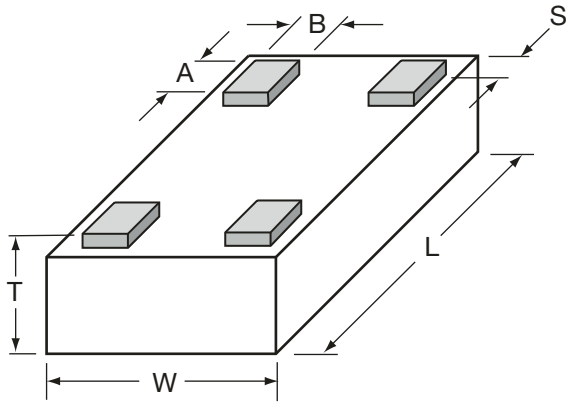

L	1.0±0.05 (0.040±0.002)	A	0.20±0.06 (0.008±0.002)
W	0.58±0.04 (0.023±0.002)	B	0.18±0.05 (0.007±0.002)
T	0.35±0.5 (0.014±0.002)	S	0.05±0.05 (0.002±0.002)

TERMINALS (Top View)

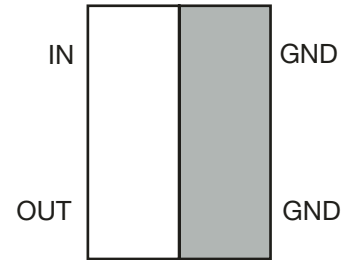

RECOMMENDED PAD LAYOUT (mm)

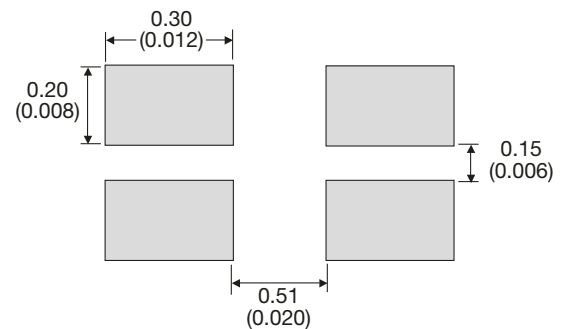

ELECTRICAL CHARACTERISTICS

(Guaranteed over -40°C to $+85^{\circ}\text{C}$ Operating Temperature Range)

P/N	Frequency Band [MHz]	I. Loss [dB]	R. Loss [dB]	Attenuation @ $2x F_0$ [dB]	Attenuation @ $3x F_0$ [dB]
LP0402N2442ANTR	2400-2484	0.35 typ 0.5 max	20	30	17
LP0402N2690ANTR	2640-2740	0.35 typ 0.5 max	20	30	20
LP0402N3500ANTR	3400-3600	0.3 typ 0.5 max	19	30	20
LP0402N5200ANTR	5500-5350	0.2 typ 0.5 max	19	30	20
LP0402N5500ANTR	5350-5650	0.2 typ 0.5 max	15	30	-
LP0402N5800ANTR	5600-6000	0.2 typ 0.5 max	16	25	-

NOTE: Additional Frequencies Available Upon Request

4

Thin-Film Low Pass Filter



LP0402N Series Harmonic Lead-Free LGA Termination

LP0402N2442ANTR

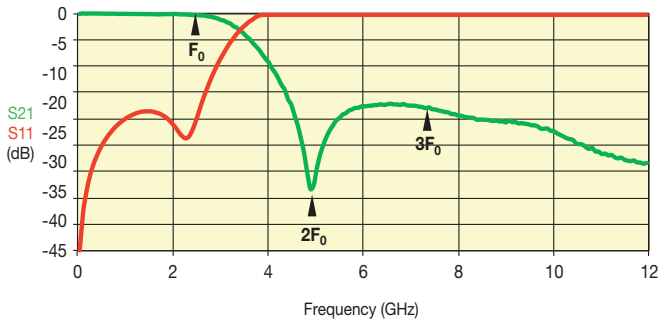

LP0402N5800ANTR

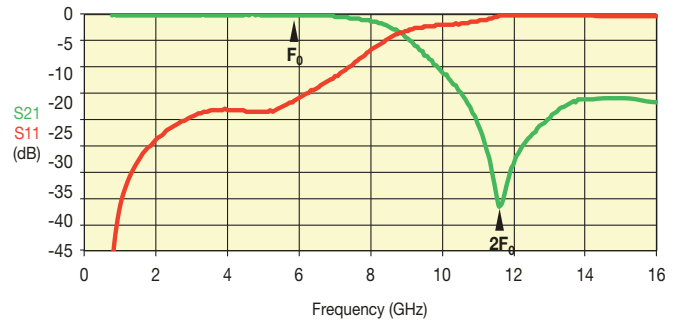

LP0402N2690ANTR

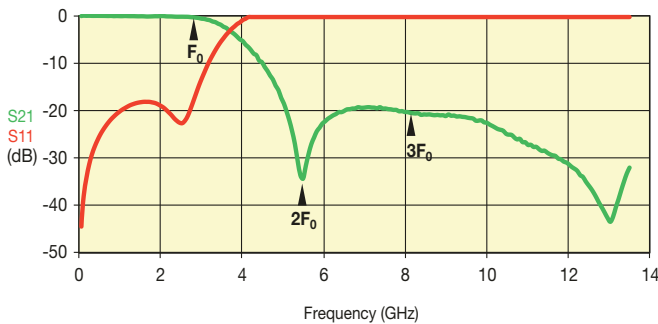

LP0402N3500ANTR

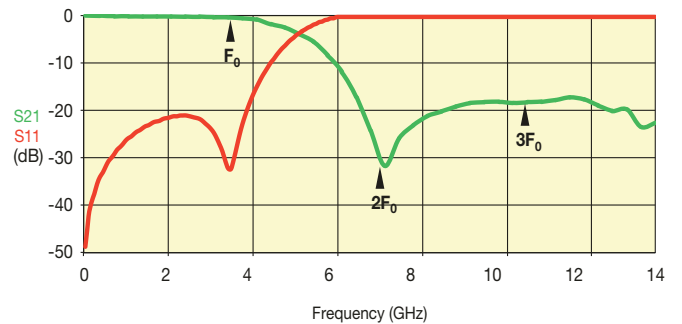

LP0402N5500ANTR

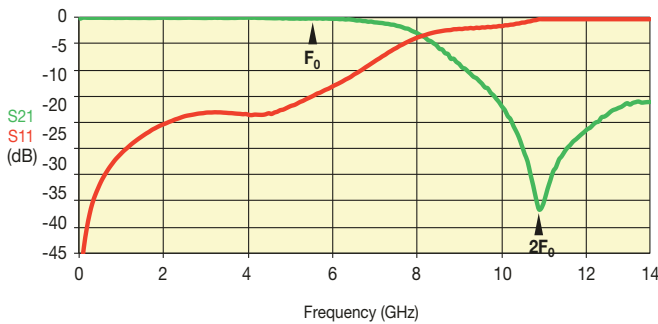

LP0402N5200ANTR

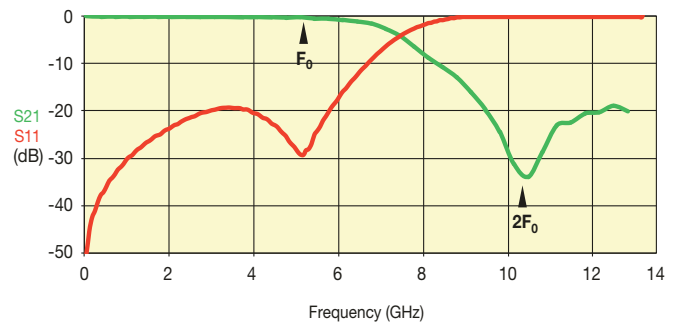

4

Thin-Film Low Pass Filter

LP0402N Series Harmonic Lead-Free LGA Termination Test Jig

TEST JIG FOR LP0402 LOW PASS FILTER

GENERAL DESCRIPTION

These jigs are designed for testing the LP0603 LGA Low Pass Filters using a Vector Network Analyzer.

They consist of a dielectric substrate, having 50Ω microstrips as conducting lines and a bottom ground plane located at a distance of 0.127mm from the microstrips.

The substrate used is Neltec's NH9338ST0127C1BC (or similar).

The connectors are SMA type (female), 'Johnson Components Inc.' Product P/N: 142-0701-841 (or similar).

Both a measurement jig and a calibration jig are provided.

The calibration jig is designed for a full 2-port calibration, and consists of an open line, short line and through line. LOAD calibration can be done by a 50Ω SMA termination.

MEASUREMENT PROCEDURE

Follow the VNA's instruction manual and use the [calibration jig](#) to perform a full 2-Port calibration in the required bandwidths.

Solder the filter to the [measurement jig](#) as follows:

Input (Filter) ➔ Connector 1 (Jig) GND (Filter) ➔ GND (Jig)

Output (Filter) ➔ Connector 2 (Jig) GND (Filter) ➔ GND (Jig)

Set the VNA to the relevant frequency band. Connect the VNA using a 10dB attenuator on the jig terminal connected to port 2 (using an RF cable).

Measurement

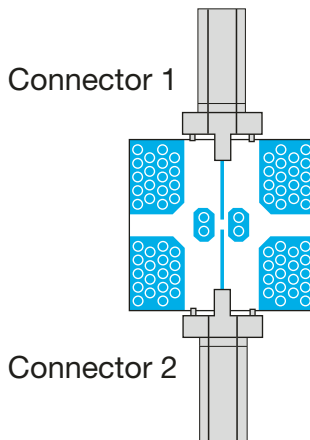

Calibration Jig

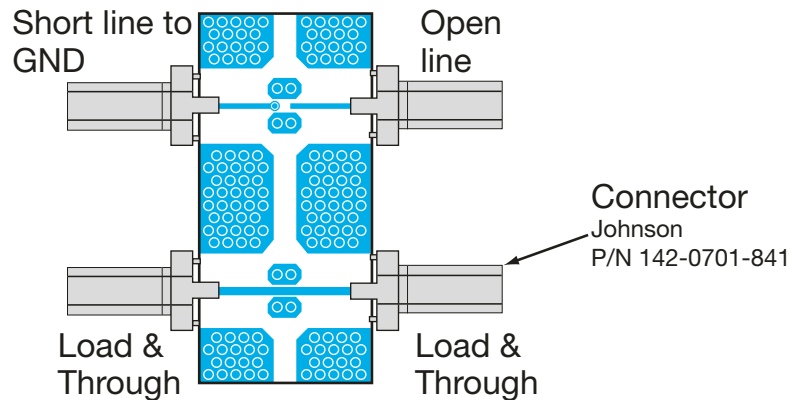

4



Компания «ЭлектроПласт» предлагает заключение долгосрочных отношений при поставках импортных электронных компонентов на взаимовыгодных условиях!

Наши преимущества:

- Оперативные поставки широкого спектра электронных компонентов отечественного и импортного производства напрямую от производителей и с крупнейших мировых складов;
- Поставка более 17-ти миллионов наименований электронных компонентов;
- Поставка сложных, дефицитных, либо снятых с производства позиций;
- Оперативные сроки поставки под заказ (от 5 рабочих дней);
- Экспресс доставка в любую точку России;
- Техническая поддержка проекта, помощь в подборе аналогов, поставка прототипов;
- Система менеджмента качества сертифицирована по Международному стандарту ISO 9001;
- Лицензия ФСБ на осуществление работ с использованием сведений, составляющих государственную тайну;
- Поставка специализированных компонентов (Xilinx, Altera, Analog Devices, Intersil, Interpoint, Microsemi, Aeroflex, Peregrine, Syfer, Eurofarad, Texas Instrument, Miteq, Cobham, E2V, MA-COM, Hittite, Mini-Circuits, General Dynamics и др.);

Помимо этого, одним из направлений компании «ЭлектроПласт» является направление «Источники питания». Мы предлагаем Вам помощь Конструкторского отдела:

- Подбор оптимального решения, техническое обоснование при выборе компонента;
- Подбор аналогов;
- Консультации по применению компонента;
- Поставка образцов и прототипов;
- Техническая поддержка проекта;
- Защита от снятия компонента с производства.



Как с нами связаться

Телефон: 8 (812) 309 58 32 (многоканальный)

Факс: 8 (812) 320-02-42

Электронная почта: org@eplast1.ru

Адрес: 198099, г. Санкт-Петербург, ул. Калинина, дом 2, корпус 4, литера А.