

# UP2UC

## UNI-PAC™ drum core power inductors

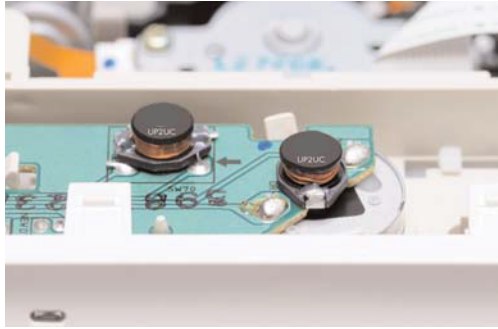

### Product features

- 12.7 mm x 9.5 mm x 5.21 mm drum core
- Inductance range from 1.0  $\mu$ H to 1000  $\mu$ H
- Current range from 0.30 A to 9.0 A
- Ferrite core material

### Applications

- Desktop computer
- Workstations/servers
- DVD Players
- Portable power devices
- Base stations
- Industrial power supplies
- Output filter chokes
- Test equipment instrumentation
- Buck or boost inductor

### Environmental data

- Storage temperature range (component):  
-40 °C to +125 °C
- Operating temperature range: -40 °C to +125 °C  
(ambient plus self-temperature rise)
- Solder reflow temperature:  
J-STD-020 (latest revision) compliant



**Product specifications**

Part Number <sup>5</sup>	OCL <sup>1</sup> μH ± 20%	I <sub>rms</sub> <sup>2</sup> (A)	I <sub>sat</sub> <sup>3</sup> (A) @ +25 °C	SRF MHz Typical	DCR mΩ @ +20 °C Typical	DCR mΩ @ +20 °C Maximum	K-factor <sup>4</sup>
UP2UC-1R0-R	1.0	6.8	9.0	100	4.0	9.0	216
UP2UC-1R5-R	1.5	6.4	8.0	90.0	4.4	10.0	177
UP2UC-2R2-R	2.2	6.1	7.0	80.0	5.8	12.0	130
UP2UC-3R3-R	3.3	5.4	6.4	65.0	9.9	15.0	114
UP2UC-4R7-R	4.7	4.8	5.4	45.0	12.0	18.0	92.52
UP2UC-6R8-R	6.8	4.4	4.6	38.0	25.8	27.0	77.72
UP2UC-100-R	10.0	3.9	3.8	30.0	25.9	38.0	62.68
UP2UC-150-R	15.0	3.1	3.0	27.0	35.4	46.0	49.82
UP2UC-220-R	22.0	2.7	2.6	19.0	55.9	85.0	41.34
UP2UC-330-R	33.0	2.1	2.0	15.0	81.6	100	34.09
UP2UC-470-R	47.0	1.8	1.6	12.0	120	140	29.00
UP2UC-680-R	68.0	1.5	1.4	10.0	145	200	24.59
UP2UC-101-R	100	1.3	1.2	9.0	211	280	20.89
UP2UC-151-R	150	1.0	1.0	6.0	347	400	15.80
UP2UC-221-R	220	0.80	0.80	5.0	491	610	13.04
UP2UC-331-R	330	0.60	0.60	4.5	750	1020	10.85
UP2UC-471-R	470	0.50	0.50	3.5	1188	1270	9.39
UP2UC-681-R	680	0.40	0.40	2.5	1811	2020	7.56
UP2UC-102-R	1000	0.30	0.30	2.0	2757	3000	6.13

1 Open Circuit Inductance (OCL) Test Parameters: 100 kHz, 0.25 V<sub>rms</sub>, 0.0 Adc

2 I<sub>rms</sub>: DC current for an approximate ΔT rise of 40 °C without core loss. Derating is necessary for AC currents. PCB layout, trace thickness and width, air-flow and proximity of other heat generating components will affect the temperature rise. It is recommended the part temperature not exceed +125 °C under worst case operating conditions verified in the end application.

3 I<sub>sat</sub>: Peak current for approximately 7.5% rolloff at +25 °C.

4 K-factor: Used to determine B<sub>p-p</sub> for core loss (see graph). B<sub>p-p</sub> = K \* L \* ΔI, B<sub>p-p</sub>: (Gauss),

K: (K-factor from table), L: (inductance in μH), ΔI (peak-to-peak ripple current in amps).

6 Part Number Definition: UP2UCU-xxx-R

- UP2UCU = Product code and size
- xxx= Inductance value in μH, R = decimal point. If no R is present, then third digit equals the number of zeros.
- "-R" suffix = RoHS compliant

**Dimensions-mm**

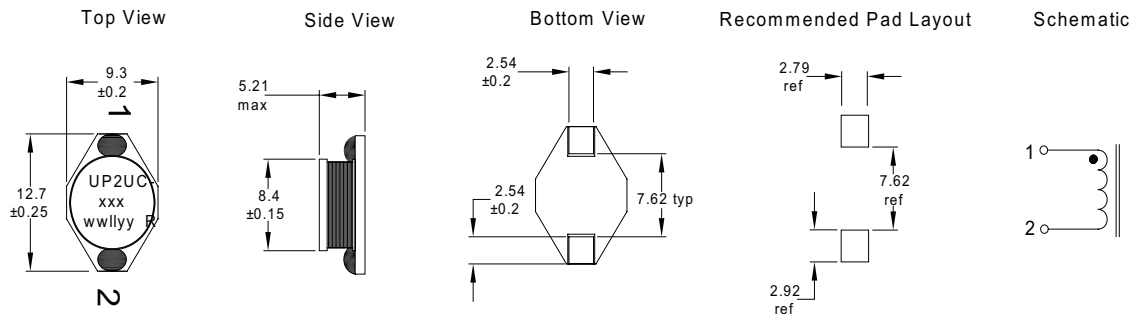

Part Marking: UP2UC

xxx = Inductance value in μH (R = Decimal point). If no "R" is present, then the third digit equals the number of zeros.

wwlllyy = Date code

R = Revision level

Tolerances are ±0.254 mm unless otherwise specified.  
Do not route traces or vias underneath the inductor

**Packaging information-mm**

Supplied in tape-and-reel packaging, 600 parts per reel, 13" diameter reel.

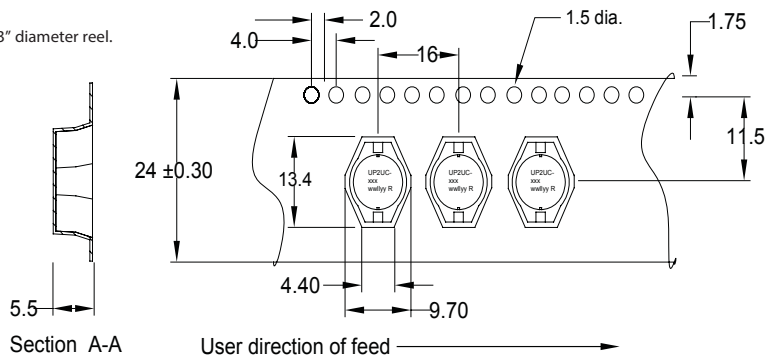

Temperature rise vs total loss

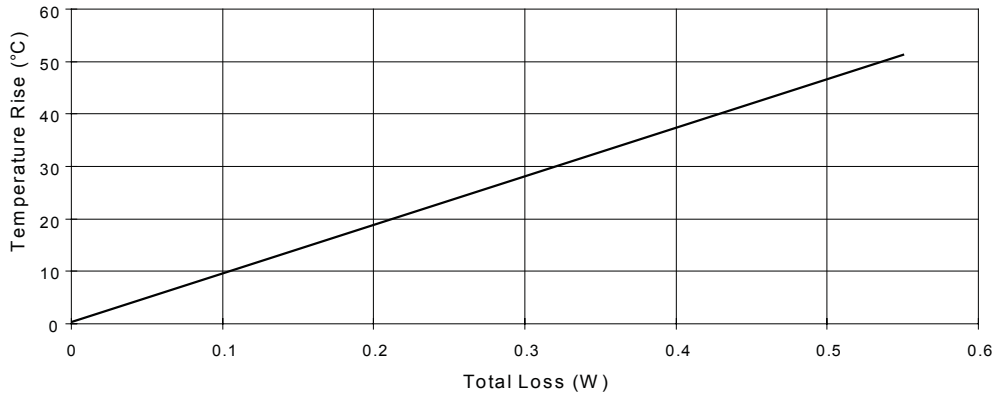

Core loss vs Bp-p

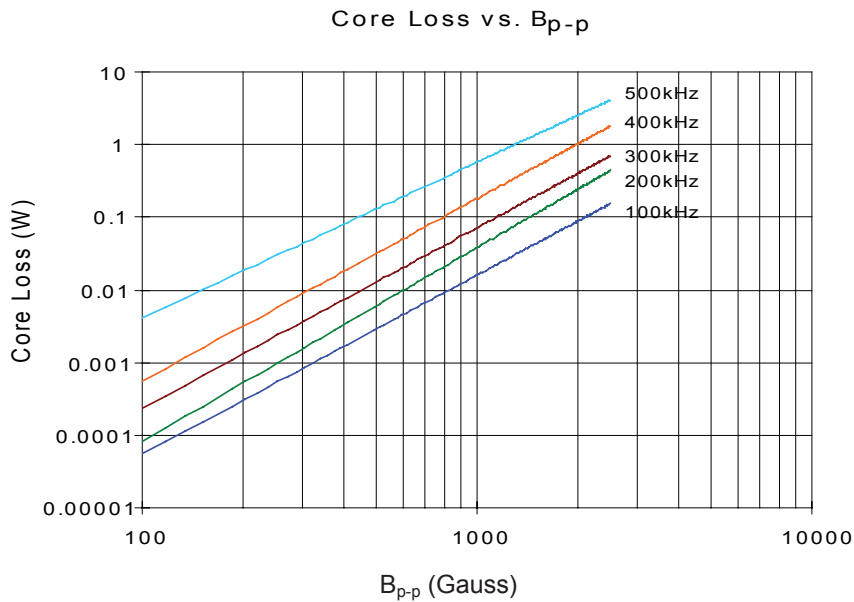

Inductance characteristics

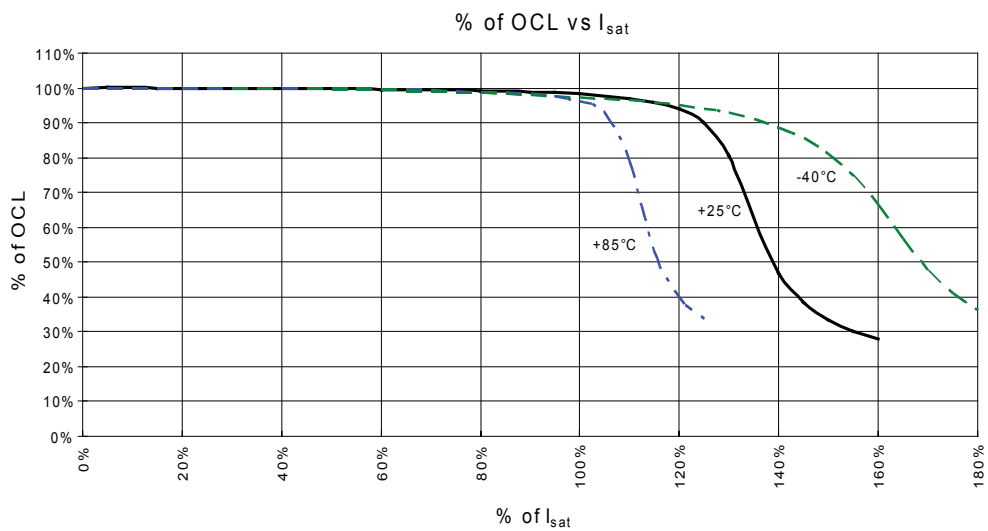

### Solder Reflow Profile

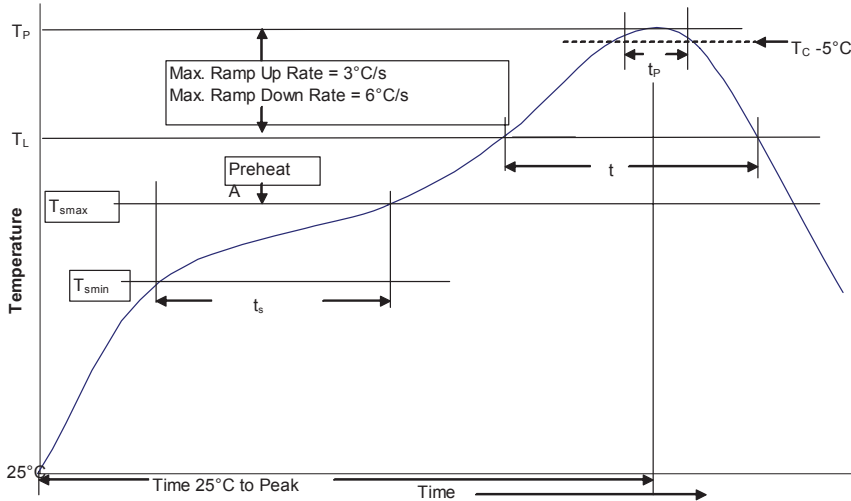

Table 1 - Standard SnPb Solder ( $T_C$ )

Package Thickness	Volume $<350$ mm <sup>3</sup>	Volume $\geq 350$ mm <sup>3</sup>
$<2.5$ mm	235°C	220°C
$\geq 2.5$ mm	220°C	220°C

Table 2 - Lead (Pb) Free Solder ( $T_C$ )

Package Thickness	Volume $<350$ mm <sup>3</sup>	Volume $350 - 2000$ mm <sup>3</sup>	Volume $>2000$ mm <sup>3</sup>
$<1.6$ mm	260°C	260°C	260°C
1.6 – 2.5mm	260°C	250°C	245°C
$>2.5$ mm	250°C	245°C	245°C

### Reference JDEC J-STD-020

Profile Feature	Standard SnPb Solder	Lead (Pb) Free Solder
Preheat and Soak		
• Temperature min. ( $T_{smin}$ )	100°C	150°C
• Temperature max. ( $T_{smax}$ )	150°C	200°C
• Time ( $T_{smin}$ to $T_{smax}$ ) ( $t_s$ )	60-120 Seconds	60-120 Seconds
Average ramp up rate $T_{smax}$ to $T_p$	3°C/ Second Max.	3°C/ Second Max.
Liquidous temperature ( $T_L$ )	183°C	217°C
Time at liquidous ( $t_L$ )	60-150 Seconds	60-150 Seconds
Peak package body temperature ( $T_p$ )*	Table 1	Table 2
Time ( $t_p$ )** within 5 °C of the specified classification temperature ( $T_C$ )	20 Seconds**	30 Seconds**
Average ramp-down rate ( $T_p$ to $T_{smax}$ )	6°C/ Second Max.	6°C/ Second Max.
Time 25°C to Peak Temperature	6 Minutes Max.	8 Minutes Max.

\* Tolerance for peak profile temperature ( $T_p$ ) is defined as a supplier minimum and a user maximum.

\*\* Tolerance for time at peak profile temperature ( $t_p$ ) is defined as a supplier minimum and a user maximum.

Life Support Policy: Eaton does not authorize the use of any of its products for use in life support devices or systems without the express written approval of an officer of the Company. Life support systems are devices which support or sustain life, and whose failure to perform, when properly used in accordance with instructions for use provided in the labeling, can be reasonably expected to result in significant injury to the user.

Eaton reserves the right, without notice, to change design or construction of any products and to discontinue or limit distribution of any products. Eaton also reserves the right to change or update, without notice, any technical information contained in this bulletin.

**Eaton**  
Electronics Division  
1000 Eaton Boulevard  
Cleveland, OH 44122  
United States  
www.eaton.com/electronics

© 2017 Eaton  
All Rights Reserved  
Printed in USA  
Publication No. 4369 BU09493  
August 2017



Компания «ЭлектроПласт» предлагает заключение долгосрочных отношений при поставках импортных электронных компонентов на взаимовыгодных условиях!

Наши преимущества:

- Оперативные поставки широкого спектра электронных компонентов отечественного и импортного производства напрямую от производителей и с крупнейших мировых складов;
- Поставка более 17-ти миллионов наименований электронных компонентов;
- Поставка сложных, дефицитных, либо снятых с производства позиций;
- Оперативные сроки поставки под заказ (от 5 рабочих дней);
- Экспресс доставка в любую точку России;
- Техническая поддержка проекта, помощь в подборе аналогов, поставка прототипов;
- Система менеджмента качества сертифицирована по Международному стандарту ISO 9001;
- Лицензия ФСБ на осуществление работ с использованием сведений, составляющих государственную тайну;
- Поставка специализированных компонентов (Xilinx, Altera, Analog Devices, Intersil, Interpoint, Microsemi, Aeroflex, Peregrine, Syfer, Eurofarad, Texas Instrument, Miteq, Cobham, E2V, MA-COM, Hittite, Mini-Circuits, General Dynamics и др.);

Помимо этого, одним из направлений компании «ЭлектроПласт» является направление «Источники питания». Мы предлагаем Вам помощь Конструкторского отдела:

- Подбор оптимального решения, техническое обоснование при выборе компонента;
- Подбор аналогов;
- Консультации по применению компонента;
- Поставка образцов и прототипов;
- Техническая поддержка проекта;
- Защита от снятия компонента с производства.



#### Как с нами связаться

**Телефон:** 8 (812) 309 58 32 (многоканальный)

**Факс:** 8 (812) 320-02-42

**Электронная почта:** [org@eplast1.ru](mailto:org@eplast1.ru)

**Адрес:** 198099, г. Санкт-Петербург, ул. Калинина, дом 2, корпус 4, литера А.