



Product Description

GRF2083 is a broadband, linear, ultra-low noise amplifier designed for small cell, wireless infrastructure and other high performance RF applications requiring ultra-low NF, high gain and linearity.

The device features an integrated shut down function which places the device into a high-isolation shut down state.

GRF2083 is a member of a family of pin compatible, ultra low noise devices which cover a wide range of frequency bands with industry leading NF and gain:

GRF2080: 0.4 to 1.5 GHz

GRF2081: 1.4 to 2.7 GHz

GRF2082: 1.9 to 3.8 GHz

GRF2083: 3.0 to 6.0 GHz

Consult with the GRF applications engineering team for application notes, custom tuning/evaluation board data and device s-parameters.

Features

Reference: 5V/70 mA/3.6 GHz

- Gain: 17.8 dB
- Eval Board NF: 0.65 dB
- OP1dB: 19.5 dBm
- OIP3: 36.5 dBm
- High Isolation Shut Down State
- Flexible Bias Voltage
- Process: GaAs pHEMT

Applications

- Cellular Infrastructure
- Small Cells and Cellular Repeaters
- Distributed Antenna Systems
- TDD Systems
- 802.11ac

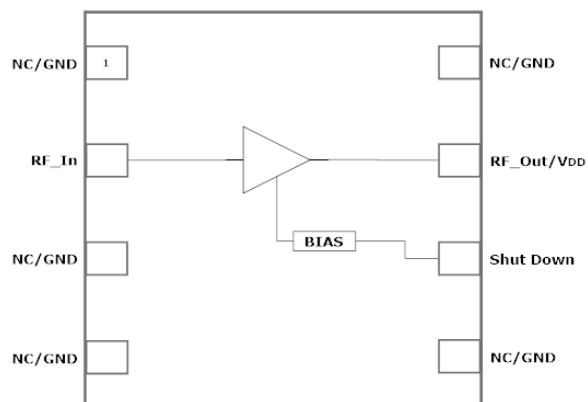

2.0 x 2.0 mm DFN-8



Preliminary

GRF2083

Ultra-LNA with Shutdown
Tuning Range: 3.0 to 6.0 GHz

Absolute Ratings:

Parameter	Symbol	Min.	Max.	Unit
Supply Voltage	V _{DD}	0	6.0	V
RF Input Power CW: (Load VSWR < 2:1; V _D : 5.0 volts)	P _{IN MAX}		23	dBm
Operating Temperature (Package Heat Sink)	T _{AMB}	-40	105	°C
Maximum Channel Temperature (MTTF > 10 ⁶ Hours)	T _{MAX}		170	°C
Maximum Dissipated Power	P _{DISS MAX}		500	mW
Electrostatic Discharge:				
Charged Device Model:	CDM	1500		V
Human Body Model:	HBM	500		V
Storage:				
Storage Temperature	T _{STG}	-65	150	°C
Moisture Sensitivity Level	MSL		1	--



Caution! ESD Sensitive Device



Exceeding Absolute Maximum Rating conditions may cause permanent damage to the device.

Note: For package dimensions and manufacturing information, see the Guerrilla-RF.com website for the following document located on the GRF2083 landing page: **Manufacturing Note—MN-001 Product Tape and Reel, Solderability and Package Outline Specification.**

[Link to manufacturing note:](#)

Pin Out (Top View)

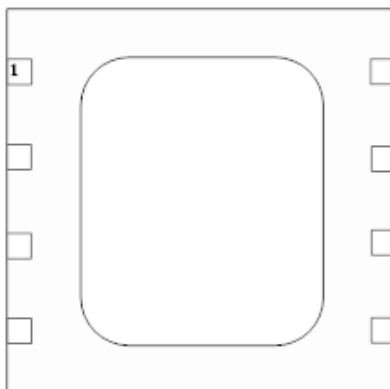

Pin Assignments:

Pin	Name	Description	Note
1	NC/GND	No Connect or Ground	No internal connection to die
2	RF_In	RF Input	External match must provide DC block
3	NC/GND	No Connect or Ground	No internal connection to die
4	NC/GND	No Connect or Ground	No internal connection to die
5	NC/GND	No Connect or Ground	No internal connection to die
6	Shut Down	Selects Shut Down Mode	See control logic truth table
7	RF_Out/VDD	RF Out	Provide device V _{DD} via external bias inductor
8	NC/GND	No Connect or Ground	No internal connection to die
PKG BASE	GND	Ground	Provides DC and RF ground for LNA, as well as thermal heat sink. Recommend multiple 8 mil vias beneath the package for optimal RF and thermal performance. Refer to evaluation board top layer graphic on schematic page.

Control Logic Truth Table:

Mode	Description	V _{DD}	V _{SHUTDOWN} (pin 6)
High Gain	High LNA Gain	High	Low
Shutdown	High Insertion Loss	High	High
Logic Level "0"	Logic Low	0.0V	0.0V to 0.2V
Logic Level "1"	Logic High	>= 2.7V	1.5V to V _{DD}



Preliminary

GRF2083

Ultra-LNA with Shutdown
Tuning Range: 3.0 to 6.0 GHz

Nominal Operating Parameters:

Parameter	Symbol	Specification			Unit	Condition
		Min.	Typ.	Max.		
Gain Mode (Pin 6: < 0.2V)						
Test Frequency	F_{TEST}		3600		MHz	$V_{DD} = 5.0\text{ V}$, $T_A = 25\text{ }^\circ\text{C}$ 3400 to 3800 MHz Tune
Evaluation Board Gain	S21		17.8		dB	
Evaluation Board Noise Figure	NF		0.65		dB	Evaluation Board SMA to SMA
Output 3rd Order Intercept Point	OIP3		36.5		dBm	4.0 dBm P_{OUT} per tone at 2 MHz Spacing (3599 and 3601 MHz)
Output 1dB Compression Point	OP1dB		19.5		dBm	
Switching Rise Time	T_{RISE}		100		ns	
Switching Fall Time	T_{FALL}		100		ns	
Supply Current	I_{DD}		70		mA	
Shutdown Mode (Pin 6: >1.5V)						
Shutdown Gain	S(2,1)		-18.5		dB	
Shutdown Current (Pin 6)	$I_{SHUTDOWN}$		40		μA	$V_{SHUTDOWN}: 1.8\text{ V}$
Leakage Current (Pin 7)	$I_{LEAKAGE}$		3.2		mA	$V_{SHUTDOWN}: 1.8\text{ V}$
Thermal Data						
Thermal Resistance (measured via IR scan)	Θ_{jc}		60		$^\circ\text{C}/\text{W}$	On standard evaluation board
Channel Temperature @ +85 C Reference (Package Heat Sink)	$T_{CHANNEL}$		106		$^\circ\text{C}$	$V_{DD}: 5.0\text{ V}$; $I_{DDQ}: 70\text{ mA}$; No RF; $P_{DISS}: 350\text{ mW}$



Preliminary

GRF2083

Ultra-LNA with Shutdown
Tuning Range: 3.0 to 6.0 GHz

GRF2083 Evaluation Board Data over Temperature:

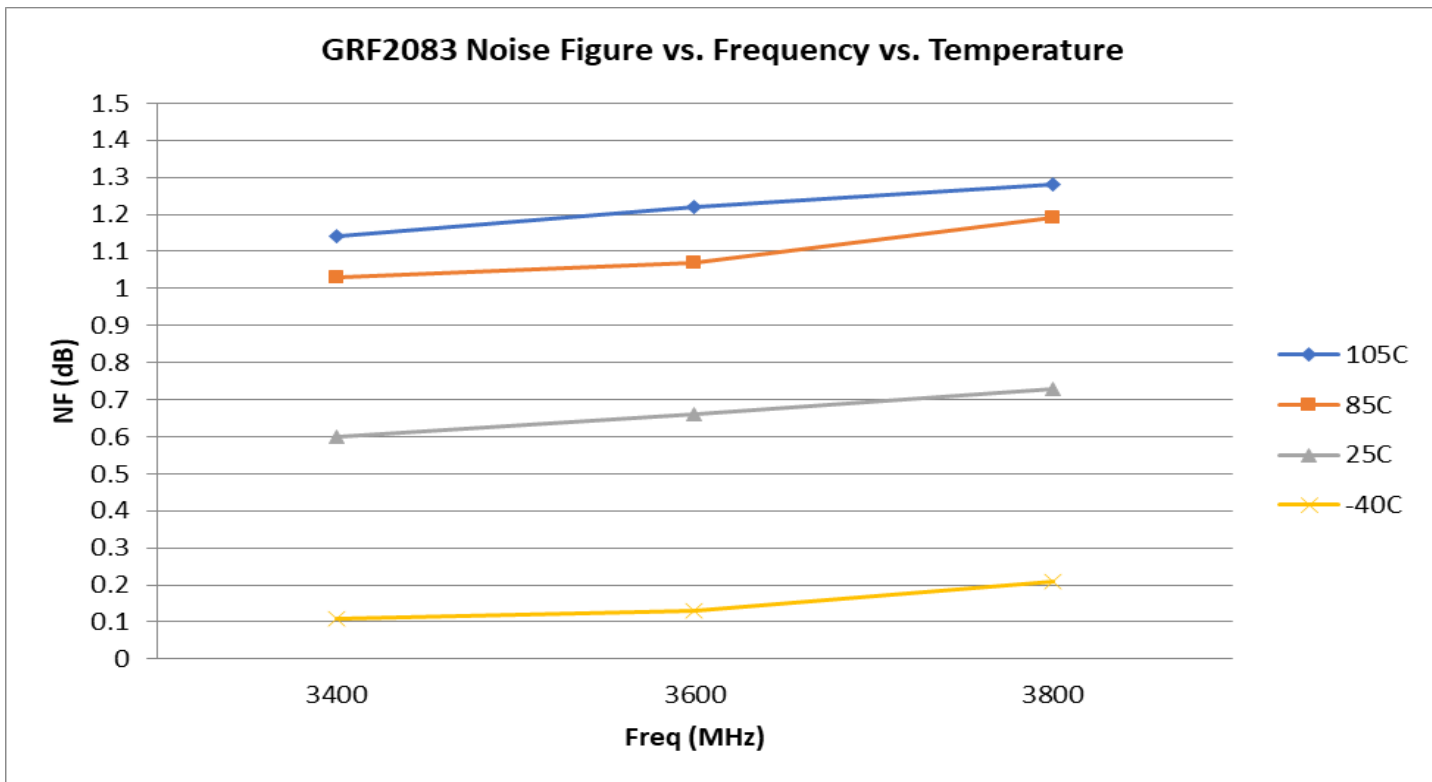
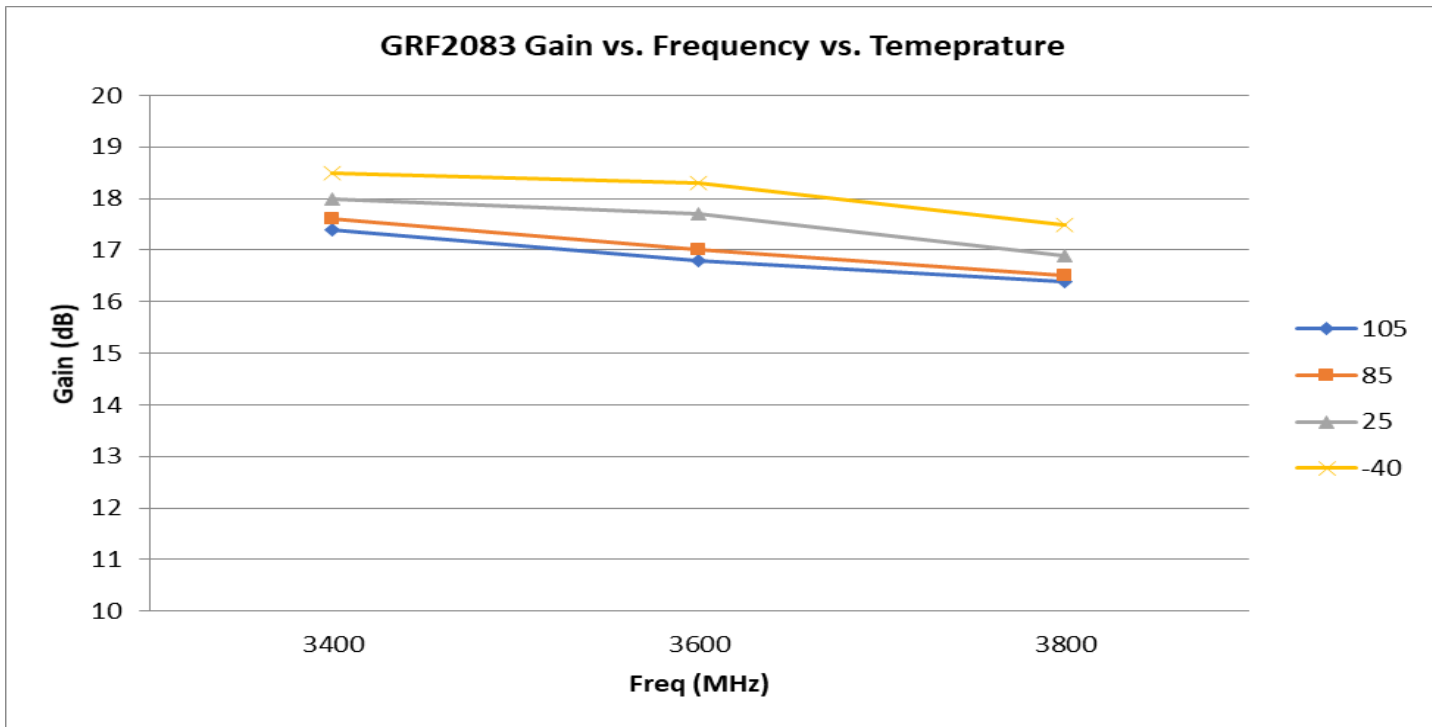



Preliminary

GRF2083

Ultra-LNA with Shutdown
Tuning Range: 3.0 to 6.0 GHz

GRF2083 Evaluation Board Data over Temperature:

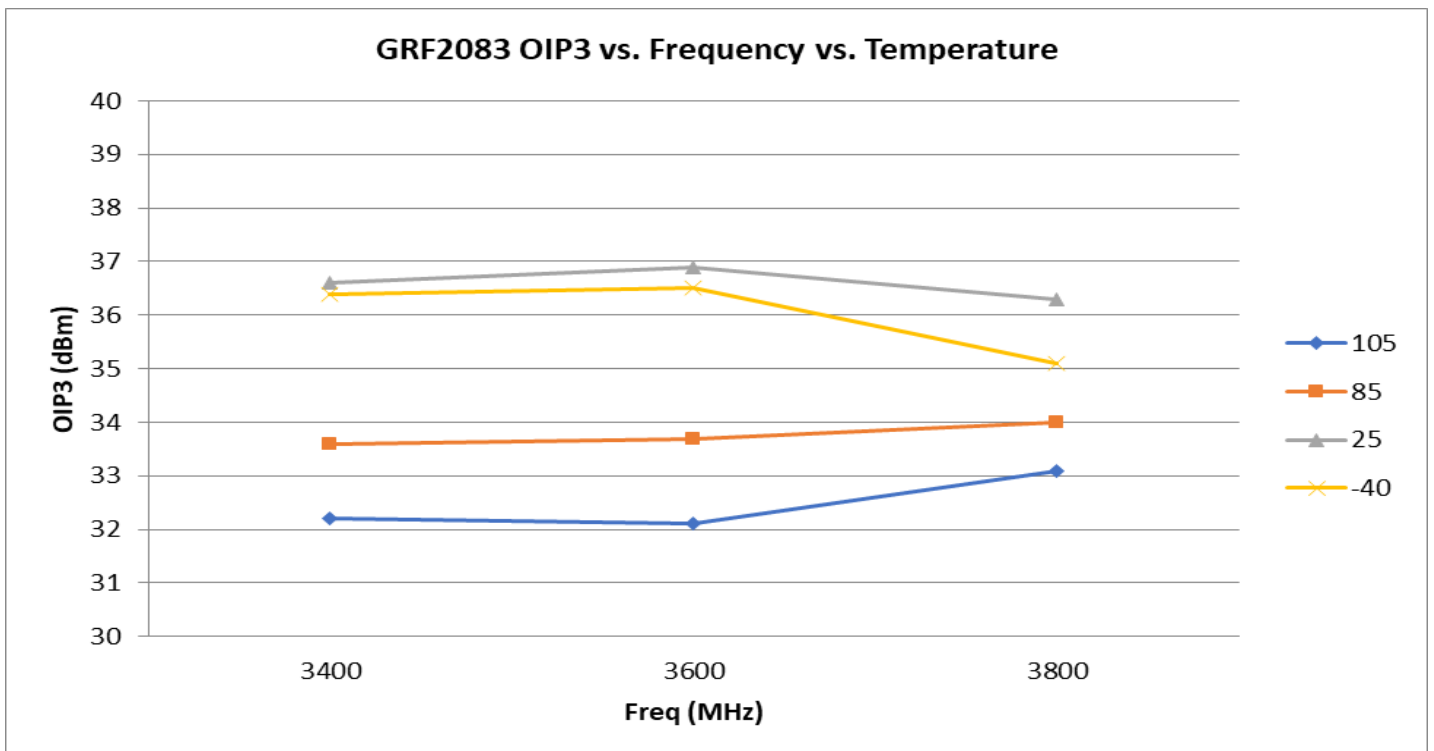
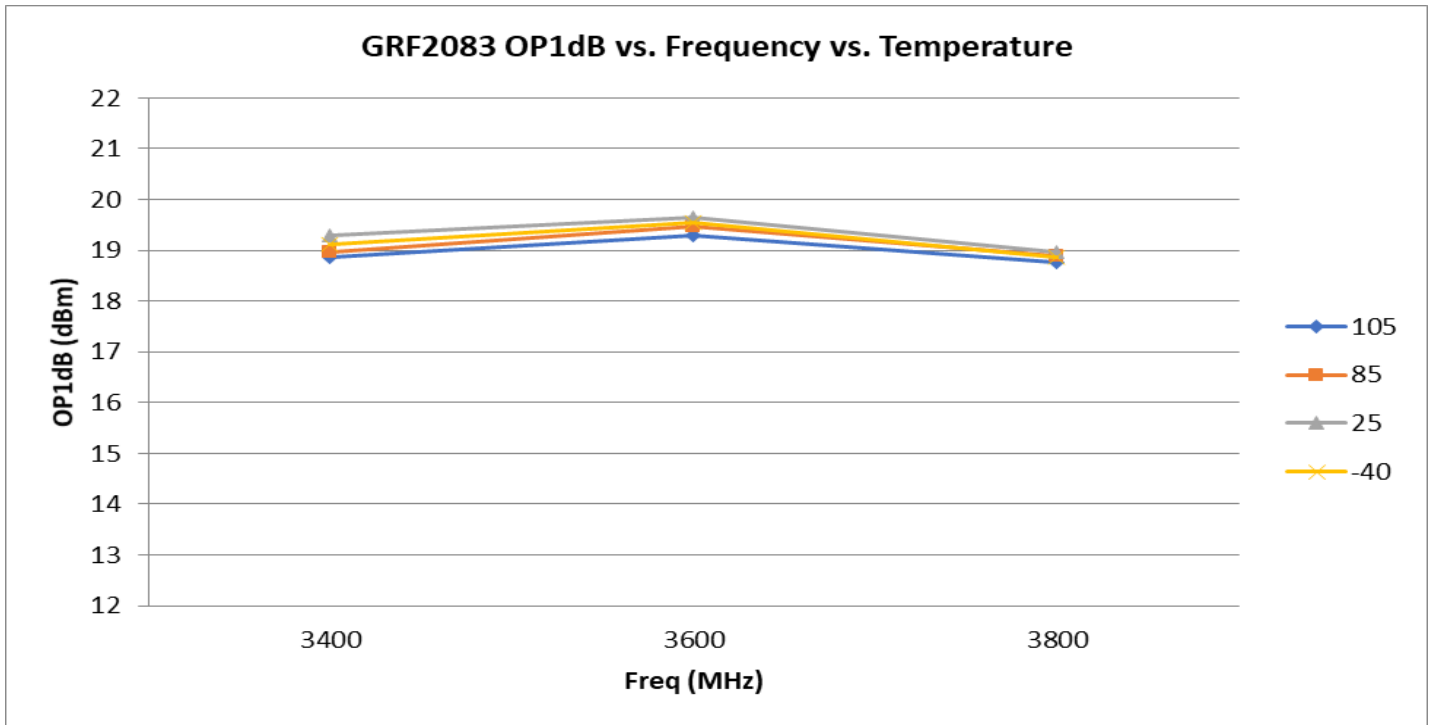



Preliminary

GRF2083

Ultra-LNA with Shutdown
Tuning Range: 3.0 to 6.0 GHz

GRF2083 Gain Mode S-Parms: (3.4 to 3.8 GHz Match)

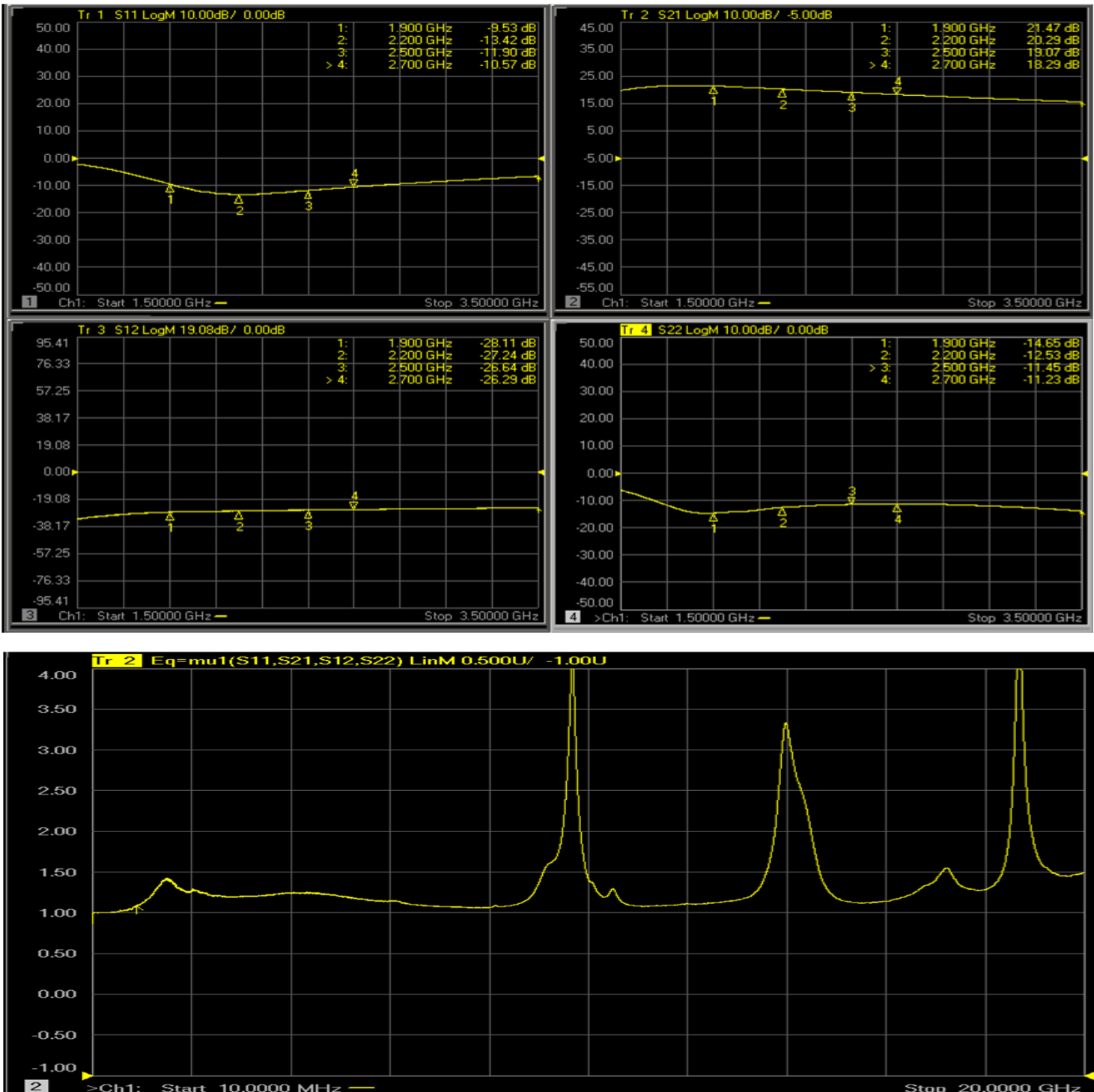

Note: Mu factor ≥ 1.0 implies unconditional stability.

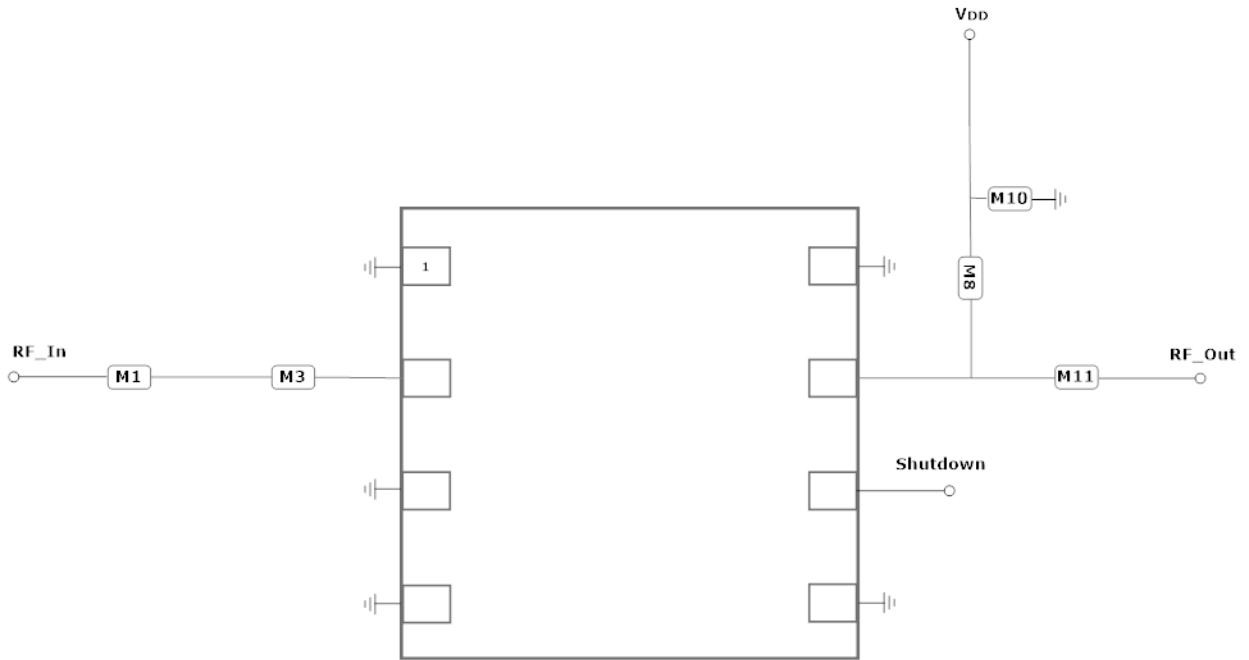

GRF2083 Application Schematic

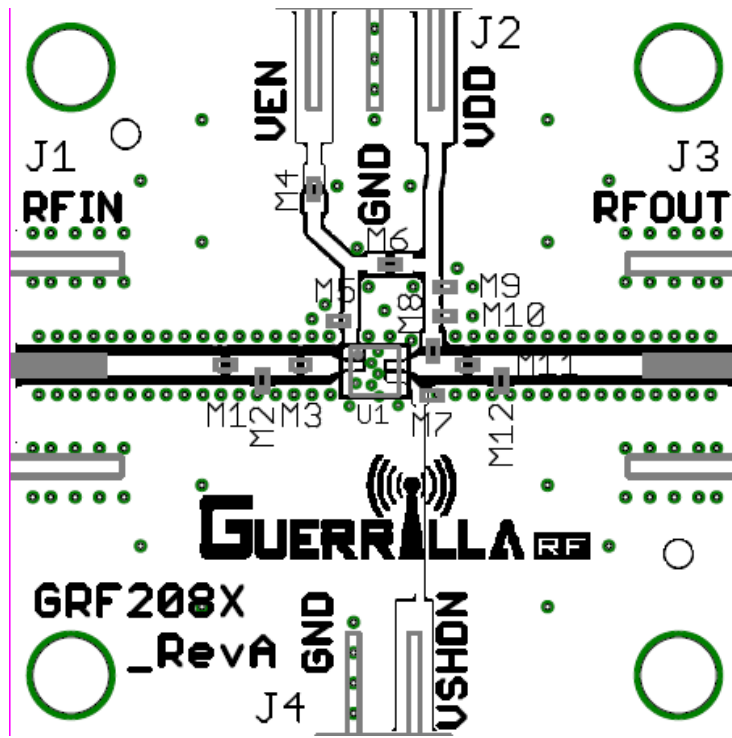

GRF2083 EVB Assembly Drawing



Preliminary

GRF2083

Ultra-LNA with Shutdown
Tuning Range: 3.0 to 6.0 GHz

GRF2082 Standard Evaluation Board BOM: (3.4 to 3.8 GHz Tune)

Component	Type	Manufacturer	Family	Value	Package Size	Substitution
M1	Capacitor	Murata	GJM	1.2 pF	0402	Ok (high Q)
M3	0 Ohm Jumper	—	—	—	0402	—
M8	Inductor	Murata	LQG	1.8 nH	0402	ok
M9	DNP	—	—	—	—	—
M10	Capacitor	Murata	GRM	0.1 uF	0402	ok
M11	Capacitor	Murata	GRM	5.1 pF	0402	ok
Evaluation Board	GRF208X_RevA	—	—	—	—	—



Preliminary

GRF2083

Ultra-LNA with Shutdown
Tuning Range: 3.0 to 6.0 GHz

Data Sheet Release Status:	Notes
Advance	S-parameter and NF data based on EM simulations for the fully packaged device using foundry supplied transistor s-parameters. Linearity estimates based on device size, bias condition and experience with related devices.
Preliminary	All data based on evaluation board measurements in the Guerrilla RF Applications Lab.
Released	All data based on device qualification data. Typically, this data is nearly identical to the data found in the preliminary version. Max and min values for key RF parameters are included.

Information in this datasheet is specific to the Guerrilla RF, Inc. ("Guerrilla RF") product identified.

This datasheet, including the information contained in it, is provided by Guerrilla RF as a service to its customers and may be used for informational purposes only by the customer. Guerrilla RF assumes no responsibility for errors or omissions on this datasheet or the information contained herein. Information provided is believed to be accurate and reliable, however, no responsibility is assumed by Guerrilla RF for its use, nor for any infringement of patents, or other rights of third parties, resulting from its use. Guerrilla RF assumes no liability for any datasheet, datasheet information, materials, products, product information, or other information provided hereunder, including the sale, distribution, reproduction or use of Guerrilla RF products, information or materials.

No license, whether express, implied, by estoppel, by implication or otherwise is granted by this datasheet for any intellectual property of Guerrilla RF, or any third party, including without limitation, patents, patent rights, copyrights, trademarks and trade secrets. All rights are reserved by Guerrilla RF.

All information herein, products, product information, datasheets, and datasheet information are subject to change and availability without notice. Guerrilla RF reserves the right to change component circuitry, recommended application circuitry and specifications at any time without prior notice. Guerrilla RF may further change its datasheet, product information, documentation, products, services, specifications or product descriptions at any time, without notice. Guerrilla RF makes no commitment to update any materials or information and shall have no responsibility whatsoever for conflicts, incompatibilities, or other difficulties arising from any future changes.

GUERRILLA RF INFORMATION, PRODUCTS, PRODUCT INFORMATION, DATASHEETS AND DATASHEET INFORMATION ARE PROVIDED "AS IS" AND WITHOUT WARRANTY OF ANY KIND, WHETHER EXPRESS, IMPLIED, STATUTORY, OR OTHERWISE, INCLUDING FITNESS FOR A PARTICULAR PURPOSE OR USE, MERCHANTABILITY, PERFORMANCE, QUALITY OR NON-INFRINGEMENT OF ANY INTELLECTUAL PROPERTY RIGHT; ALL SUCH WARRANTIES ARE HEREBY EXPRESSLY DISCLAIMED. GUERRILLA RF DOES NOT WARRANT THE ACCURACY OR COMPLETENESS OF THE INFORMATION, TEXT, GRAPHICS OR OTHER ITEMS CONTAINED WITHIN THESE MATERIALS. GUERRILLA RF SHALL NOT BE LIABLE FOR ANY DAMAGES, INCLUDING BUT NOT LIMITED TO ANY SPECIAL, INDIRECT, INCIDENTAL, STATUTORY, OR CONSEQUENTIAL DAMAGES, INCLUDING WITHOUT LIMITATION, LOST REVENUES OR LOST PROFITS THAT MAY RESULT FROM THE USE OF THE MATERIALS OR INFORMATION, WHETHER OR NOT THE RECIPIENT OF MATERIALS HAS BEEN ADVISED OF THE POSSIBILITY OF SUCH DAMAGE.

Customers are solely responsible for their use of Guerrilla RF products in the Customer's products and applications or in ways which deviate from Guerrilla RF's published specifications, either intentionally or as a result of design defects, errors, or operation of products outside of published parameters or design specifications. Customers should include design and operating safeguards to minimize these and other risks. Guerrilla RF assumes no liability or responsibility for applications assistance, customer product design, or damage to any equipment resulting from the use of Guerrilla RF products outside of stated published specifications or parameters.



Компания «ЭлектроПласт» предлагает заключение долгосрочных отношений при поставках импортных электронных компонентов на взаимовыгодных условиях!

Наши преимущества:

- Оперативные поставки широкого спектра электронных компонентов отечественного и импортного производства напрямую от производителей и с крупнейших мировых складов;
- Поставка более 17-ти миллионов наименований электронных компонентов;
- Поставка сложных, дефицитных, либо снятых с производства позиций;
- Оперативные сроки поставки под заказ (от 5 рабочих дней);
- Экспресс доставка в любую точку России;
- Техническая поддержка проекта, помощь в подборе аналогов, поставка прототипов;
- Система менеджмента качества сертифицирована по Международному стандарту ISO 9001;
- Лицензия ФСБ на осуществление работ с использованием сведений, составляющих государственную тайну;
- Поставка специализированных компонентов (Xilinx, Altera, Analog Devices, Intersil, Interpoint, Microsemi, Aeroflex, Peregrine, Syfer, Eurofarad, Texas Instrument, Miteq, Cobham, E2V, MA-COM, Hittite, Mini-Circuits, General Dynamics и др.);

Помимо этого, одним из направлений компании «ЭлектроПласт» является направление «Источники питания». Мы предлагаем Вам помощь Конструкторского отдела:

- Подбор оптимального решения, техническое обоснование при выборе компонента;
- Подбор аналогов;
- Консультации по применению компонента;
- Поставка образцов и прототипов;
- Техническая поддержка проекта;
- Защита от снятия компонента с производства.



Как с нами связаться

Телефон: 8 (812) 309 58 32 (многоканальный)

Факс: 8 (812) 320-02-42

Электронная почта: org@eplast1.ru

Адрес: 198099, г. Санкт-Петербург, ул. Калинина, дом 2, корпус 4, литера А.