

# MA4EX180H-1225T

## Silicon Double Balanced HMIC™ Mixer, 1300 - 1900 MHz

Rev. V2

### Features

- SOT-25 Low Cost Miniature Plastic Package
- 6.5 dB Typical Conversion Loss at 1550 MHz
- 7.6 dB Typical Conversion Loss at 1800 MHz
- +13 to +17 dBm LO Drive
- HMIC™ Patented Process
- Silicon High Barrier Schottky Diodes
- DC - 500 MHz IF Bandwidth

### Description and Applications

M/A-COM's MA4EX180H-1225T is a silicon monolithic 1300-1900 MHz double balanced mixer in a low cost miniature surface mount SOT-25 package. The die uses M/A-COM's unique HMIC™ silicon/glass process to achieve low loss passive elements while retaining the advantages of high barrier silicon Schottky diodes.

These mixers are well suited for high volume wireless and cellular applications where small size and repeatability are required. Typical applications include frequency conversion, modulation, and demodulation for receivers and transmitters in both portable cellular and base station applications.

### SOT-25 Package Outline (Topview)

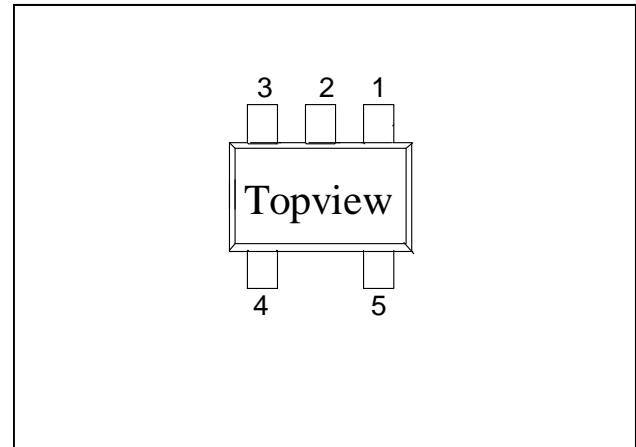

### PIN Configuration

PIN	Function	PIN	Function
1	GND	4	RF
2	GND	5	LO
3	IF		

### Absolute Maximum Ratings<sup>1</sup>

Parameter	Maximum Ratings
Operating Temperature	-40 °C to +85 °C
Storage Temperature	-65 °C to +150 °C
Incident LO Power	+20 dBm
Incident RF Power	+20 dBm

1. Exceeding these limits may cause permanent damage.

### Functional Schematic

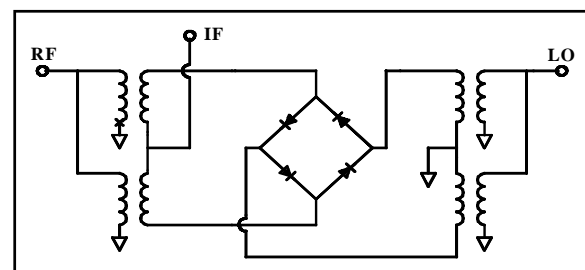

# MA4EX180H-1225T



Silicon Double Balanced HMIC™ Mixer,  
1300 - 1900 MHz

Rev. V2

## Electrical Specifications: $T_A = + 25\text{ }^\circ\text{C}$

Parameter	Frequency Range	Test Conditions	Units	Min.	Typ.	Max.
Conversion Loss	1550 MHz	LO Drive = +15 dBm	dB		6.5	7.5
	1300-1900 MHz	RF = -10 dBm, IF = 60 MHz	dB		7.5	9.5
L - R Isolation	1550 MHz	LO Drive = +15 dBm	dB		27.0	
	1300-1900 MHz	RF Level = -10 dBm	dB		18.6	
L - I Isolation	1550 MHz	LO Drive = +15 dBm	dB		28.9	
	1300-1900 MHz	RF Level = -10 dBm	dB		24.0	
R - I Isolation	1550 MHz	LO Drive = +15 dBm	dB		15.8	
	1300-1900 MHz	RF Level = -10 dBm	dB		16.9	
RF VSWR	1550 MHz	LO Drive = +15 dBm			1.4:1	
	1300-1900 MHz	RF Level = -10 dBm			2.1:1	
IF VSWR	DC - 500 MHz	LO Drive = +15 dBm RF Level = -10 dBm			1.5:1	
Input IP3	1550 MHz	LO Drive = +15 dBm	dBm	19.5	23.0	
	1300-1900 MHz	IF = 60 MHz	dBm	17.5	22.0	
Input 1 dB Compression	1550 MHz	LO Drive = +15 dBm	dBm	7.5	8.5	
	1300-1900 MHz	IF = 60 MHz	dBm	7.5	9.5	
IF 1 dB Bandwidth			MHz	0	500.0	

# MA4EX180H-1225T



Silicon Double Balanced HMIC™ Mixer,  
1300 - 1900 MHz

Rev. V2

## Typical Performance Curves (LO Drive = +15 dBm, RF = -10 dBm, IF = 60 MHz)

Conversion Loss

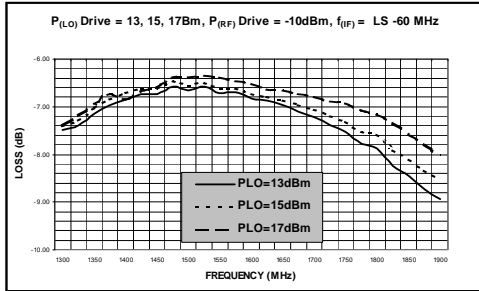

Isolation

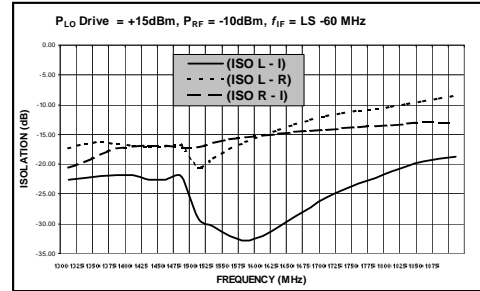

RF and IF VSWR

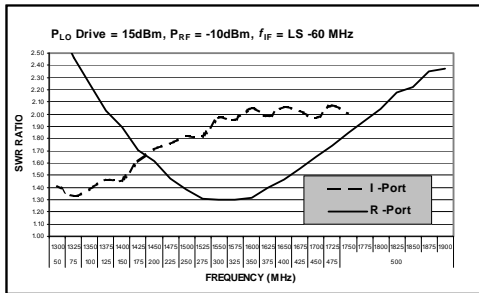

Third Order Intercept and Input 1 dB Compression Power

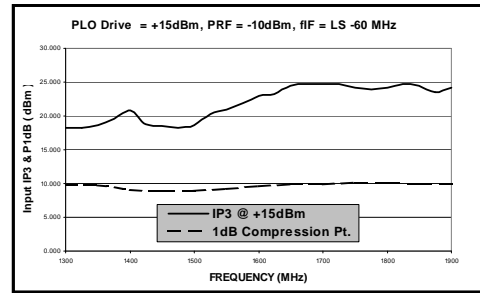

**ADVANCED:** Data Sheets contain information regarding a product M/A-COM Technology Solutions is considering for development. Performance is based on target specifications, simulated results, and/or prototype measurements. Commitment to develop is not guaranteed.  
**PRELIMINARY:** Data Sheets contain information regarding a product M/A-COM Technology Solutions has under development. Performance is based on engineering tests. Specifications are typical. Mechanical outline has been fixed. Engineering samples and/or test data may be available. Commitment to produce in volume is not guaranteed.

• **North America** Tel: 800.366.2266 • **Europe** Tel: +353.21.244.6400  
 • **India** Tel: +91.80.43537383 • **China** Tel: +86.21.2407.1588  
 Visit [www.macomtech.com](http://www.macomtech.com) for additional data sheets and product information.

M/A-COM Technology Solutions Inc. and its affiliates reserve the right to make changes to the product(s) or information contained herein without notice.

# MA4EX180H-1225T

Silicon Double Balanced HMIC™ Mixer,  
1300 - 1900 MHz

Rev. V2

## SOT-25 Package Outline<sup>1,2</sup>

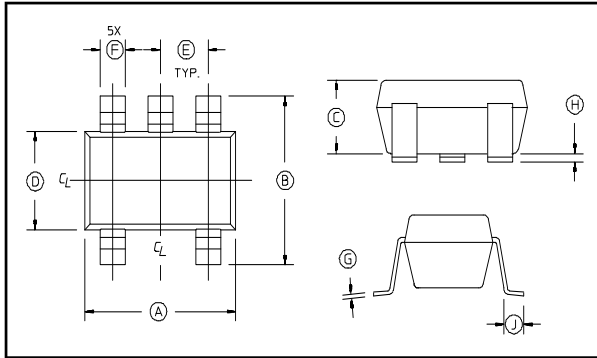

1. Dimensions do not include mold flash, protrusion or gate burrs which shall not exceed 0.0098 in (.25mm) per side.
2. Lead Coplanarity is 0.003 (0.08) max.

## SOT-25 Dimensions

Dim	Inches		Millimeters	
	Min.	Max.	Min.	Max.
A		.122	2.70	3.10
B	.100	.118	2.54	3.00
C	—	.051	—	1.30
D	.063 REF.		1.60 REF.	
E	.032	.043	.80	1.10
F	.014	.020	.35	.50
G	.003	—	.08	—
H	.000	.006	.00	.15
J	.018 REF.		.45 REF.	

## Ordering Information

Part Number	Package
MA4EX180H-1225T	Tape and Reel



Компания «ЭлектроПласт» предлагает заключение долгосрочных отношений при поставках импортных электронных компонентов на взаимовыгодных условиях!

Наши преимущества:

- Оперативные поставки широкого спектра электронных компонентов отечественного и импортного производства напрямую от производителей и с крупнейших мировых складов;
- Поставка более 17-ти миллионов наименований электронных компонентов;
- Поставка сложных, дефицитных, либо снятых с производства позиций;
- Оперативные сроки поставки под заказ (от 5 рабочих дней);
- Экспресс доставка в любую точку России;
- Техническая поддержка проекта, помощь в подборе аналогов, поставка прототипов;
- Система менеджмента качества сертифицирована по Международному стандарту ISO 9001;
- Лицензия ФСБ на осуществление работ с использованием сведений, составляющих государственную тайну;
- Поставка специализированных компонентов (Xilinx, Altera, Analog Devices, Intersil, Interpoint, Microsemi, Aeroflex, Peregrine, Syfer, Eurofarad, Texas Instrument, Miteq, Cobham, E2V, MA-COM, Hittite, Mini-Circuits, General Dynamics и др.);

Помимо этого, одним из направлений компании «ЭлектроПласт» является направление «Источники питания». Мы предлагаем Вам помощь Конструкторского отдела:

- Подбор оптимального решения, техническое обоснование при выборе компонента;
- Подбор аналогов;
- Консультации по применению компонента;
- Поставка образцов и прототипов;
- Техническая поддержка проекта;
- Защита от снятия компонента с производства.



#### Как с нами связаться

**Телефон:** 8 (812) 309 58 32 (многоканальный)

**Факс:** 8 (812) 320-02-42

**Электронная почта:** [org@eplast1.ru](mailto:org@eplast1.ru)

**Адрес:** 198099, г. Санкт-Петербург, ул. Калинина, дом 2, корпус 4, литера А.