

3500 series

High performance toggle switches •
environmentally sealed



DISTINCTIVE FEATURES

- Completely sealed switches withstanding 0.1 bar pressure
- Approved to European standards CECC 96000
- Three types of terminals
- Many lever styles available



ENVIRONMENTAL SPECIFICATIONS

- Front sealing to IP67 or IP69K by a silicone membrane (for sealed panel mounting, add washer U60).
- Rear sealing to IP64 provided by moulded-in terminal inserts
- Operating temperature : -40 °C to + 85°C (-40 °F to +185 °F)
- Moisture resistance : 56 days



ELECTRICAL SPECIFICATIONS

- Max. current/voltage rating with resistive load and electrical life at full load: see table below
- Initial contact resistance : 10 mΩ max. at 1 A 2 VDC
- Insulation resistance : 1,000 MΩ
- Dielectric strength : 2,500 Vrms 50 Hz min. between terminals
3,000 Vrms 50 Hz min. between terminals and frame

FUNCTIONS	GENERAL PERFORMANCES
ON-OFF and ON-ON	10,000 cycles, T20 °C 15 A 28 VDC resistive 15 A 28 VDC inductive 5 A 28 VDC lamp
ON OFF ON	10,000 cycles, T20 °C 15 A 28 VDC resistive 15 A 28 VDC inductive 5 A 28 VDC lamp
OTHER FUNCTIONS	10,000 cycles, T20 °C 15 A 28 VDC resistive 10 A 28 VDC inductive 3 A 28 VDC lamp

The company reserves the right to change specifications without notice.



3500 series

High performance toggle switches • environmentally sealed



GENERAL SPECIFICATIONS

- Mechanical life : 40,000 cycles
- Torque : 2 Nm (1.47 Ft.lb) max. applied to nut
- Panel thickness :
For NON-SEALED mounting (panel cut-out fig. 1, 2 or 3) : 5 mm (.196) max.
For SEALED mounting (panel cut-out fig. 2) : 4 mm (.157) max.



MATERIALS

- Case : mineral filled polyester UL94-V0
- Bushing and cover : zamac
- Actuator : brass, nickel or chrome plated, or anodized aluminum
- Contacts : silver alloy

AGENCY APPROVAL



CECC 96201-004

Availability : consult factory for details of approved models.

Marking : to order switches marked CECC, complete appropriate box of ordering format.



TERMINALS

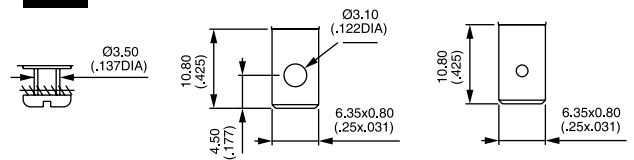

ELECTRICAL FUNCTIONS

→ KEYWAY

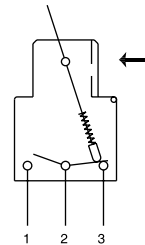

PANEL CUT-OUT

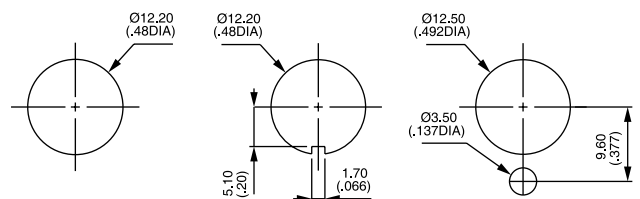

Figure 1

Figure 2

Figure 3

3500 series

High performance toggle switches • environmentally sealed



BUILD YOUR PART NUMBER

BASIC PART NUMBER

SERIES	NUMBER OF POLES	ELECTRICAL FUNCTIONS	TERMINALS																																																																					
35																																																																								
	<table border="1"> <tr><td>3</td><td>Single pole</td></tr> <tr><td>4</td><td>Double pole</td></tr> </table>	3	Single pole	4	Double pole	<table border="1"> <tr><td>1-0</td><td>ON</td><td>-</td><td>OFF</td></tr> <tr><td>2-0</td><td>ON</td><td>-</td><td>m.OFF</td></tr> <tr><td>3-0</td><td>OFF</td><td>-</td><td>MOM</td></tr> <tr><td>4-1</td><td>ON</td><td>³ON⁴</td><td>ON ▲</td></tr> <tr><td>4-2</td><td>ON</td><td>³ON⁴</td><td>MOM ▲</td></tr> <tr><td>4-3</td><td>MOM</td><td>³ON⁴</td><td>MOM ▲</td></tr> <tr><td>4-4</td><td>ON</td><td>¹ON⁶</td><td>ON ▲</td></tr> <tr><td>4-5</td><td>ON</td><td>¹ON⁶</td><td>MOM ▲</td></tr> </table>	1-0	ON	-	OFF	2-0	ON	-	m.OFF	3-0	OFF	-	MOM	4-1	ON	³ ON ⁴	ON ▲	4-2	ON	³ ON ⁴	MOM ▲	4-3	MOM	³ ON ⁴	MOM ▲	4-4	ON	¹ ON ⁶	ON ▲	4-5	ON	¹ ON ⁶	MOM ▲	<table border="1"> <tr><td>4-6</td><td>MOM</td><td>¹ON⁶</td><td>MOM ▲</td></tr> <tr><td>5-0</td><td>ON</td><td>-</td><td>MOM</td></tr> <tr><td>6-0</td><td>ON</td><td>-</td><td>ON</td></tr> <tr><td>7-0</td><td>MOM</td><td>OFF</td><td>MOM</td></tr> <tr><td>8-0</td><td>ON</td><td>OFF</td><td>MOM</td></tr> <tr><td>9-0</td><td>ON</td><td>OFF</td><td>ON</td></tr> </table>	4-6	MOM	¹ ON ⁶	MOM ▲	5-0	ON	-	MOM	6-0	ON	-	ON	7-0	MOM	OFF	MOM	8-0	ON	OFF	MOM	9-0	ON	OFF	ON	<table border="1"> <tr><td>0</td><td>Screw</td></tr> <tr><td>2</td><td>Solder lug/ quick-connect</td></tr> <tr><td>3</td><td>Normalized quick-connect</td></tr> <tr><td>4</td><td>Screw + clamp</td></tr> </table>	0	Screw	2	Solder lug/ quick-connect	3	Normalized quick-connect	4	Screw + clamp
3	Single pole																																																																							
4	Double pole																																																																							
1-0	ON	-	OFF																																																																					
2-0	ON	-	m.OFF																																																																					
3-0	OFF	-	MOM																																																																					
4-1	ON	³ ON ⁴	ON ▲																																																																					
4-2	ON	³ ON ⁴	MOM ▲																																																																					
4-3	MOM	³ ON ⁴	MOM ▲																																																																					
4-4	ON	¹ ON ⁶	ON ▲																																																																					
4-5	ON	¹ ON ⁶	MOM ▲																																																																					
4-6	MOM	¹ ON ⁶	MOM ▲																																																																					
5-0	ON	-	MOM																																																																					
6-0	ON	-	ON																																																																					
7-0	MOM	OFF	MOM																																																																					
8-0	ON	OFF	MOM																																																																					
9-0	ON	OFF	ON																																																																					
0	Screw																																																																							
2	Solder lug/ quick-connect																																																																							
3	Normalized quick-connect																																																																							
4	Screw + clamp																																																																							

▲ Function 4 : double pole only

OPTIONS

LEVER FINISH	AGENCY APPROVAL	LOCKING LEVER SPECIAL FINISH																								
<table border="1"> <tr><td>N</td><td>Bright nickel</td></tr> <tr><td>B</td><td>Satin chrome</td></tr> <tr><td>G*</td><td>Black</td></tr> <tr><td>F*</td><td>Black with fluorescent tip (lever type 1 only)</td></tr> <tr><td>C</td><td>Painted or anodized</td></tr> </table> <p>*Black finish on bushing too.</p>	N	Bright nickel	B	Satin chrome	G*	Black	F*	Black with fluorescent tip (lever type 1 only)	C	Painted or anodized	<table border="1"> <tr><td>0</td><td>None</td></tr> <tr><td>1</td><td>CECC</td></tr> </table>	0	None	1	CECC	<table border="1"> <tr><td>(blank)</td><td>None</td></tr> <tr><td>P5</td><td>Painted yellow</td></tr> <tr><td>A6</td><td>Anodized red</td></tr> </table> <p>Order with lever finish type C. Other colors : on request.</p>	(blank)	None	P5	Painted yellow	A6	Anodized red				
N	Bright nickel																									
B	Satin chrome																									
G*	Black																									
F*	Black with fluorescent tip (lever type 1 only)																									
C	Painted or anodized																									
0	None																									
1	CECC																									
(blank)	None																									
P5	Painted yellow																									
A6	Anodized red																									
LEVER STYLES	LEVER LOCKING STYLES	ACCESSORIES																								
<table border="1"> <tr><td>1</td><td>Standard, length 17.5 mm (.688) or locking, length 20 mm (.787)</td></tr> <tr><td>2</td><td>Length 30 mm (1.181)</td></tr> <tr><td>3</td><td>Flatted, length 24 mm (.944)</td></tr> <tr><td>4</td><td>Length 40 mm (1.574)</td></tr> <tr><td>5</td><td>Length 50 mm (1.968)</td></tr> <tr><td>6</td><td>Locking, length 25.4 mm (1.000)</td></tr> </table>	1	Standard, length 17.5 mm (.688) or locking, length 20 mm (.787)	2	Length 30 mm (1.181)	3	Flatted, length 24 mm (.944)	4	Length 40 mm (1.574)	5	Length 50 mm (1.968)	6	Locking, length 25.4 mm (1.000)	<table border="1"> <tr><td>0</td><td>No locking</td></tr> <tr><td>A</td><td>Locked in 3 positions</td></tr> <tr><td>D</td><td>Locked out of center position</td></tr> <tr><td>G</td><td>Locked in keyway side</td></tr> </table> <p>See drawings on the following pages.</p>	0	No locking	A	Locked in 3 positions	D	Locked out of center position	G	Locked in keyway side	<table border="1"> <tr><td>0</td><td>2 hex nuts, 1 locking ring and 1 lockwasher (non-sealed mounting)</td></tr> <tr><td>2</td><td>2 hex nuts and 1 sealing washer (sealed mounting)</td></tr> </table>	0	2 hex nuts, 1 locking ring and 1 lockwasher (non-sealed mounting)	2	2 hex nuts and 1 sealing washer (sealed mounting)
1	Standard, length 17.5 mm (.688) or locking, length 20 mm (.787)																									
2	Length 30 mm (1.181)																									
3	Flatted, length 24 mm (.944)																									
4	Length 40 mm (1.574)																									
5	Length 50 mm (1.968)																									
6	Locking, length 25.4 mm (1.000)																									
0	No locking																									
A	Locked in 3 positions																									
D	Locked out of center position																									
G	Locked in keyway side																									
0	2 hex nuts, 1 locking ring and 1 lockwasher (non-sealed mounting)																									
2	2 hex nuts and 1 sealing washer (sealed mounting)																									



ABOUT THIS SERIES

On the following pages, you will find successively basic part numbers of switches and options in the same order as in above chart.

- ⚠ **Notice** : please note that not all combinations of above numbers are available. Refer to the following pages for further information.
- 🛡 **Switch guards** are available to prevent inadvertent lever operation. See "Switch Guards" section of website.
- 🔧 **Mounting accessories** : see above and on the following pages.

3500 series

High performance toggle switches • environmentally sealed

SCREW TERMINALS SINGLE POLE



	Angle of throw (A)	III A2-A3	II	I
3531-00	22°	ON	-	OFF
3532-00	22°	ON	-	m.OFF
3533-00	22°	OFF	-	MOM
3535-00	22°	ON	-	MOM
3536-00	22°	ON	-	ON
3537-00	22°	MOM	OFF	MOM
3538-00	30°	ON	OFF	MOM
3539-00	30°	ON	OFF	ON

SCREW TERMINALS DOUBLE POLE



	Angle of throw (A)	III A2-A3 B5-B6	II *A3-B5 **A1-B5	I A1-A2 B5-B4
3541-00	22°	ON	-	OFF
3544-10	22°	ON	ON*	ON
3544-20	22°	ON	ON*	MOM
3544-30	22°	MOM	ON*	MOM
3545-00	22°	ON	-	MOM
3546-00	22°	ON	-	ON
3547-00	22°	MOM	OFF	MOM
3548-00	30°	ON	OFF	MOM
3549-00	30°	ON	OFF	ON

SOLDER LUG/QUICK-CONNECT TERMINALS SINGLE POLE



	Angle of throw (A)	III A2-A3	II	I
3531-02	22°	ON	-	OFF
3532-02	22°	ON	-	m.OFF
3533-02	22°	OFF	-	MOM
3535-02	22°	ON	-	MOM
3536-02	22°	ON	-	ON
3537-02	22°	MOM	OFF	MOM
3538-02	30°	ON	OFF	MOM
3539-02	30°	ON	OFF	ON

SOLDER LUG/QUICK-CONNECT TERMINALS DOUBLE POLE



	Angle of throw (A)	III A2-A3 B5-B6	II *A3-B5 **A1-B5	I A1-A2 B5-B4
3541-02	22°	ON	-	OFF
3544-12	22°	ON	ON*	ON
3544-22	22°	ON	ON*	MOM
3544-32	22°	MOM	ON*	MOM
3545-02	22°	ON	-	MOM
3546-02	22°	ON	-	ON
3547-02	22°	MOM	OFF	MOM
3548-02	30°	ON	OFF	MOM
3549-02	30°	ON	OFF	ON

→ KEYWAY

Shown with standard lever

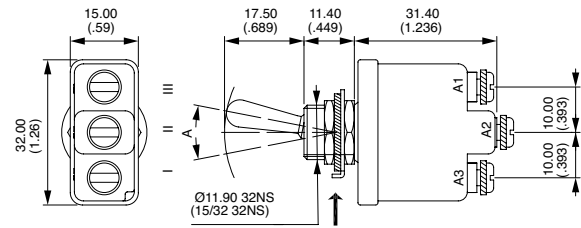

→ KEYWAY

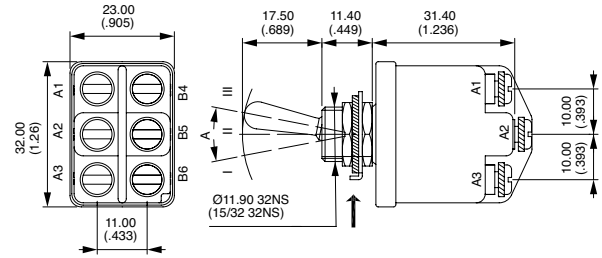

Also available in functions ON-m.OFF and OFF-MOM.

→ KEYWAY

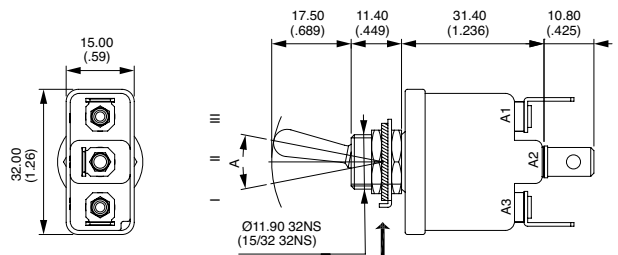

→ KEYWAY

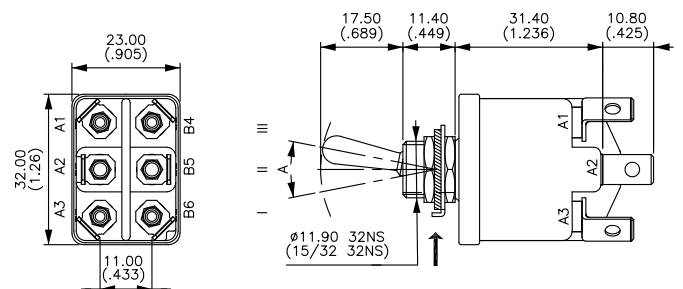

Also available in functions ON-m.OFF and OFF-MOM.

*and** : A2-B4 and A2-B6 = jumper to be wired by the user.

3500 series

High performance toggle switches • environmentally sealed

NORMALIZED QUICK-CONNECT TERMINALS SINGLE POLE



	Angle of throw (A)	III A2-A3	II	I A1-A2
3531-03	22°	ON	-	OFF
3532-03	22°	ON	-	m.OFF
3533-03	22°	OFF	-	MOM
3535-03	22°	ON	-	MOM
3536-03	22°	ON	-	ON
3537-03	22°	MOM	OFF	MOM
3538-03	30°	ON	OFF	MOM
3539-03	30°	ON	OFF	ON

→ KEYWAY

Shown with standard lever

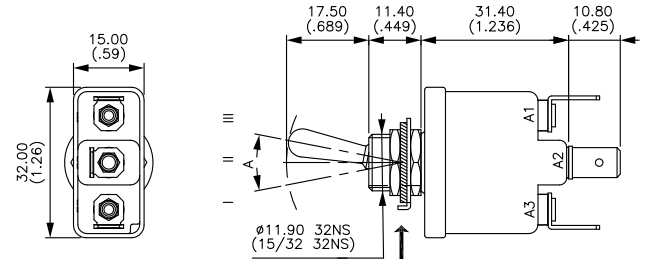

NORMALIZED QUICK-CONNECT TERMINALS DOUBLE POLE



	Angle of throw (A)	III A2-A3 B5-B6	II *A3-B5 **A1-B5	I A1-A2 B5-B4
3541-03	22°	ON	-	OFF
3544-13	22°	ON	ON*	ON
3544-23	22°	ON	ON*	MOM
3544-33	22°	MOM	ON*	MOM
3545-03	22°	ON	-	MOM
3546-03	22°	ON	-	ON
3547-03	22°	MOM	OFF	MOM
3548-03	30°	ON	OFF	MOM
3549-03	30°	ON	OFF	ON

→ KEYWAY

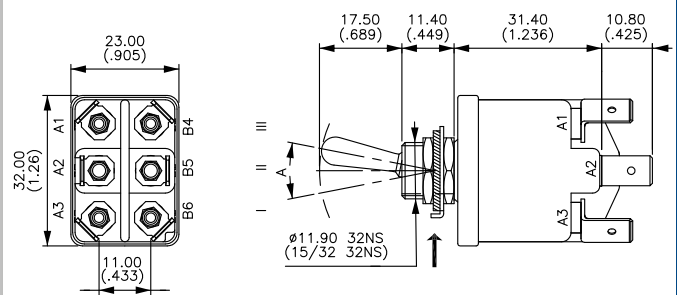

Also available in functions ON-m.OFF and OFF-MOM.

*and**: A2-B4 and A2-B6 = jumper to be wired by the user.

LEVER STYLES

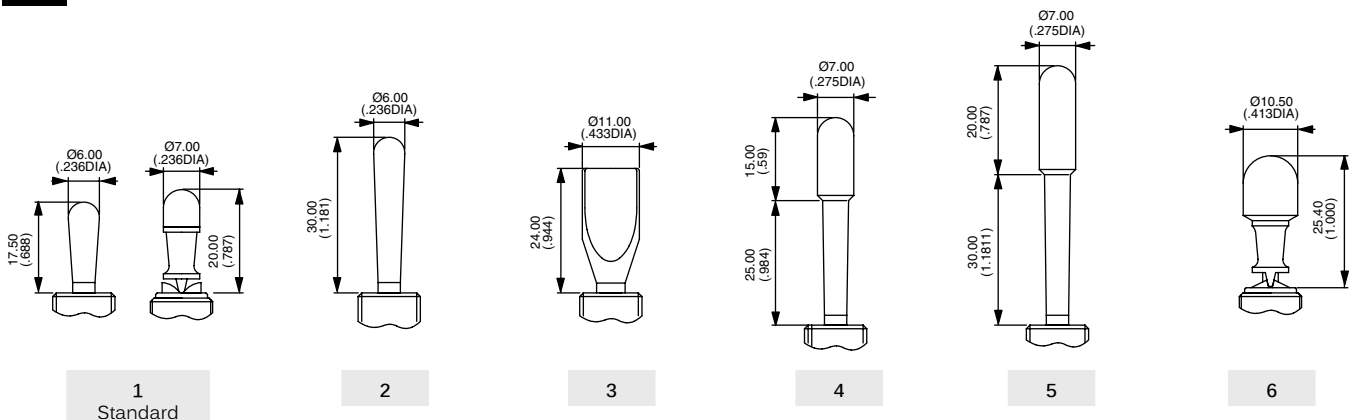

3500 series

High performance toggle switches • environmentally sealed

LEVER FINISH



- N Bright nickel
- B Satin chrome
- G* Black
- F* Black with fluorescent tip (available with lever type 1 only)
- C Painted or anodized (for locking lever only)

* Black finish on bushing too.

LOCKING LEVER STYLES



- 0 No locking
- A Locked in 3 positions. For functions 4-1, 4-4 and 9-0.
- D Locked out of center position. For functions 1-0 and 6-0.
- G Locked in keyway. For functions 1-0 and 6-0.

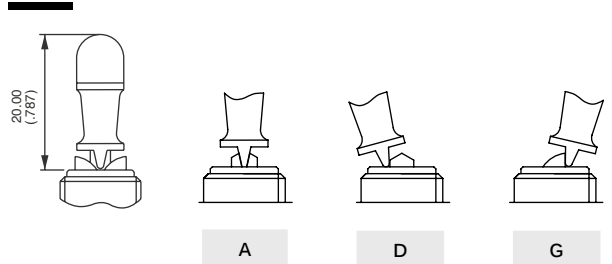

AGENCY APPROVAL



- 0 None
- 1 CECC

MOUNTING ACCESSORIES



- 0 For NON-SEALED mounting (panel cut-out fig. 1, 2 or 3)
2 hex nuts 14 mm (.551) across flats, 1 locking ring U121 or U12, 1 lockwasher U13
Panel thickness : 5 mm (.196) max.
- 2 For SEALED mounting (panel cut-out fig. 2)
2 hex nuts 14 mm (.551) across flats and 1 sealing washer U60
Panel thickness : 4 mm (.157) max.

Special hardware : black cap nut U129. Order separately. See "Hardware" section of website.

LOCKING LEVER SPECIAL FINISH



- (blank) None
 - P5 Painted yellow
 - A6 Anodized red
- Order with lever finish type C.
Other colors on request.



Компания «ЭлектроПласт» предлагает заключение долгосрочных отношений при поставках импортных электронных компонентов на взаимовыгодных условиях!

Наши преимущества:

- Оперативные поставки широкого спектра электронных компонентов отечественного и импортного производства напрямую от производителей и с крупнейших мировых складов;
- Поставка более 17-ти миллионов наименований электронных компонентов;
- Поставка сложных, дефицитных, либо снятых с производства позиций;
- Оперативные сроки поставки под заказ (от 5 рабочих дней);
- Экспресс доставка в любую точку России;
- Техническая поддержка проекта, помощь в подборе аналогов, поставка прототипов;
- Система менеджмента качества сертифицирована по Международному стандарту ISO 9001;
- Лицензия ФСБ на осуществление работ с использованием сведений, составляющих государственную тайну;
- Поставка специализированных компонентов (Xilinx, Altera, Analog Devices, Intersil, Interpoint, Microsemi, Aeroflex, Peregrine, Syfer, Eurofarad, Texas Instrument, Miteq, Cobham, E2V, MA-COM, Hittite, Mini-Circuits, General Dynamics и др.);

Помимо этого, одним из направлений компании «ЭлектроПласт» является направление «Источники питания». Мы предлагаем Вам помощь Конструкторского отдела:

- Подбор оптимального решения, техническое обоснование при выборе компонента;
- Подбор аналогов;
- Консультации по применению компонента;
- Поставка образцов и прототипов;
- Техническая поддержка проекта;
- Защита от снятия компонента с производства.



Как с нами связаться

Телефон: 8 (812) 309 58 32 (многоканальный)

Факс: 8 (812) 320-02-42

Электронная почта: org@eplast1.ru

Адрес: 198099, г. Санкт-Петербург, ул. Калинина, дом 2, корпус 4, литера А.