

3500 series

High performance toggle switches •
environmentally sealed



DISTINCTIVE FEATURES

- Completely sealed switches withstanding 0.1 bar pressure
- Approved to European standards CECC 96000
- Three types of terminals
- Many lever styles available



ENVIRONMENTAL SPECIFICATIONS

- Front sealing to IP67 or IP69K by a silicone membrane (for sealed panel mounting, add washer U60).
- Rear sealing to IP64 provided by moulded-in terminal inserts
- Operating temperature : -40 °C to + 85°C (-40 °F to +185 °F)
- Moisture resistance : 56 days



ELECTRICAL SPECIFICATIONS

- Max. current/voltage rating with resistive load and electrical life at full load: see table below
- Initial contact resistance : 10 mΩ max. at 1 A 2 VDC
- Insulation resistance : 1,000 MΩ
- Dielectric strength : 2,500 Vrms 50 Hz min. between terminals
3,000 Vrms 50 Hz min. between terminals and frame

| FUNCTIONS | GENERAL PERFORMANCES |
|------------------------|--|
| ON-OFF and ON-ON | 10,000 cycles, T20 °C 15 A 28 VDC resistive 15 A 28 VDC inductive 5 A 28 VDC lamp |
| ON OFF ON | 10,000 cycles, T20 °C 15 A 28 VDC resistive 15 A 28 VDC inductive 5 A 28 VDC lamp |
| OTHER FUNCTIONS | 10,000 cycles, T20 °C 15 A 28 VDC resistive 10 A 28 VDC inductive 3 A 28 VDC lamp |

The company reserves the right to change specifications without notice.



3500 series

High performance toggle switches • environmentally sealed



GENERAL SPECIFICATIONS

- Mechanical life : 40,000 cycles
- Torque : 2 Nm (1.47 Ft.lb) max. applied to nut
- Panel thickness :
 For NON-SEALED mounting (panel cut-out fig. 1, 2 or 3) :
 5 mm (.196) max.
 For SEALED mounting (panel cut-out fig. 2) :
 4 mm (.157) max.



MATERIALS

- Case : mineral filled polyester UL94-V0
- Bushing and cover : zamac
- Actuator : brass, nickel or chrome plated, or anodized aluminum
- Contacts : silver alloy

AGENCY APPROVAL



CECC 96201-004

Availability : consult factory for details of approved models.

Marking : to order switches marked CECC, complete appropriate box of ordering format.



TERMINALS

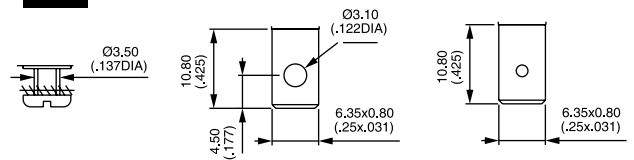

ELECTRICAL FUNCTIONS

→ KEYWAY

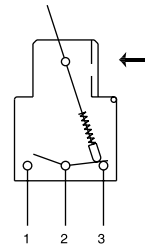

PANEL CUT-OUT

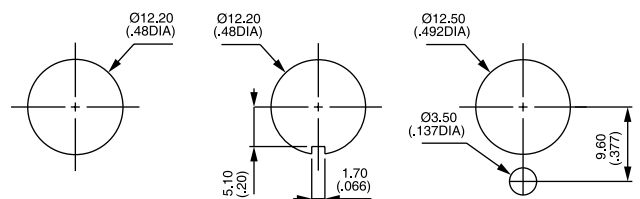

Figure 1

Figure 2

Figure 3

3500 series

High performance toggle switches • environmentally sealed



BUILD YOUR PART NUMBER

BASIC PART NUMBER

| SERIES | NUMBER OF POLES | ELECTRICAL FUNCTIONS | TERMINALS |
|--------|-----------------|--|----------------------------|
| 35 | | | |
| 3 | Single pole | 1-0 ON - OFF | 0 Screw |
| 4 | Double pole | 2-0 ON - m.OFF | 2 Solder lug/quick-connect |
| | | 3-0 OFF - MOM | 3 Normalized quick-connect |
| | | 4-1 ON ³ ON ⁴ ON ▲ | 4 Screw + clamp |
| | | 4-2 ON ³ ON ⁴ MOM ▲ | |
| | | 4-3 MOM ³ ON ⁴ MOM ▲ | |
| | | 4-4 ON ¹ ON ⁶ ON ▲ | |
| | | 4-5 ON ¹ ON ⁶ MOM ▲ | |
| | | 4-6 MOM ¹ ON ⁶ MOM ▲ | |
| | | 5-0 ON - MOM | |
| | | 6-0 ON - ON | |
| | | 7-0 MOM OFF MOM | |
| | | 8-0 ON OFF MOM | |
| | | 9-0 ON OFF ON | |

▲ Function 4 : double pole only

OPTIONS

| LEVER FINISH | AGENCY APPROVAL | LOCKING LEVER SPECIAL FINISH |
|---|-----------------|--|
| N Bright nickel | 0 None | (blank) None |
| B Satin chrome | 1 CECC | P5 Painted yellow |
| G* Black | | A6 Anodized red |
| F* Black with fluorescent tip (lever type 1 only) | | Order with lever finish type C. Other colors : on request. |
| C Painted or anodized | | |

*Black finish on bushing too.

| LEVER STYLES | LEVER LOCKING STYLES | ACCESSORIES |
|---|--------------------------------------|---|
| 1 Standard, length 17.5 mm (.688) or locking, length 20 mm (.787) | 0 No locking | 0 2 hex nuts, 1 locking ring and 1 lockwasher (non-sealed mounting) |
| 2 Length 30 mm (1.181) | A Locked in 3 positions | 2 2 hex nuts and 1 sealing washer (sealed mounting) |
| 3 Flatted, length 24 mm (.944) | D Locked out of center position | |
| 4 Length 40 mm (1.574) | G Locked in keyway side | |
| 5 Length 50 mm (1.968) | | |
| 6 Locking, length 25.4 mm (1.000) | See drawings on the following pages. | |



ABOUT THIS SERIES

On the following pages, you will find successively basic part numbers of switches and options in the same order as in above chart.

- ⚠ **Notice** : please note that not all combinations of above numbers are available. Refer to the following pages for further information.
- 🛡 **Switch guards** are available to prevent inadvertent lever operation. See "Switch Guards" section of website.
- 🔧 **Mounting accessories** : see above and on the following pages.

3500 series

High performance toggle switches • environmentally sealed

SCREW TERMINALS SINGLE POLE



| | Angle of throw (A) | III A2-A3 | II | I |
|---------|--------------------|--------------|-----|-------|
| 3531-00 | 22° | ON | - | OFF |
| 3532-00 | 22° | ON | - | m.OFF |
| 3533-00 | 22° | OFF | - | MOM |
| 3535-00 | 22° | ON | - | MOM |
| 3536-00 | 22° | ON | - | ON |
| 3537-00 | 22° | MOM | OFF | MOM |
| 3538-00 | 30° | ON | OFF | MOM |
| 3539-00 | 30° | ON | OFF | ON |

SCREW TERMINALS DOUBLE POLE



| | Angle of throw (A) | III A2-A3 B5-B6 | II *A3-B5 **A1-B5 | I A1-A2 B5-B4 |
|---------|--------------------|-----------------------|-------------------------|---------------------|
| 3541-00 | 22° | ON | - | OFF |
| 3544-10 | 22° | ON | ON* | ON |
| 3544-20 | 22° | ON | ON* | MOM |
| 3544-30 | 22° | MOM | ON* | MOM |
| 3545-00 | 22° | ON | - | MOM |
| 3546-00 | 22° | ON | - | ON |
| 3547-00 | 22° | MOM | OFF | MOM |
| 3548-00 | 30° | ON | OFF | MOM |
| 3549-00 | 30° | ON | OFF | ON |

SOLDER LUG/QUICK-CONNECT TERMINALS SINGLE POLE



| | Angle of throw (A) | III A2-A3 | II | I |
|---------|--------------------|--------------|-----|-------|
| 3531-02 | 22° | ON | - | OFF |
| 3532-02 | 22° | ON | - | m.OFF |
| 3533-02 | 22° | OFF | - | MOM |
| 3535-02 | 22° | ON | - | MOM |
| 3536-02 | 22° | ON | - | ON |
| 3537-02 | 22° | MOM | OFF | MOM |
| 3538-02 | 30° | ON | OFF | MOM |
| 3539-02 | 30° | ON | OFF | ON |

SOLDER LUG/QUICK-CONNECT TERMINALS DOUBLE POLE



| | Angle of throw (A) | III A2-A3 B5-B6 | II *A3-B5 **A1-B5 | I A1-A2 B5-B4 |
|---------|--------------------|-----------------------|-------------------------|---------------------|
| 3541-02 | 22° | ON | - | OFF |
| 3544-12 | 22° | ON | ON* | ON |
| 3544-22 | 22° | ON | ON* | MOM |
| 3544-32 | 22° | MOM | ON* | MOM |
| 3545-02 | 22° | ON | - | MOM |
| 3546-02 | 22° | ON | - | ON |
| 3547-02 | 22° | MOM | OFF | MOM |
| 3548-02 | 30° | ON | OFF | MOM |
| 3549-02 | 30° | ON | OFF | ON |

→ KEYWAY

Shown with standard lever

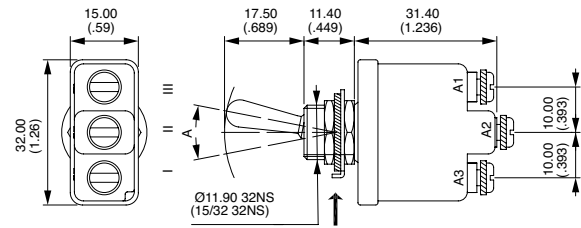

→ KEYWAY

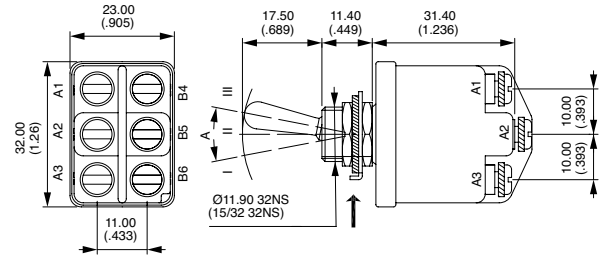

Also available in functions ON-m.OFF and OFF-MOM.

→ KEYWAY

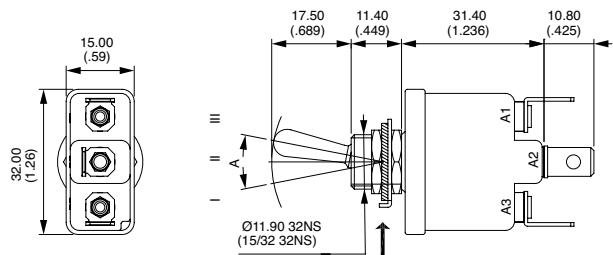

→ KEYWAY

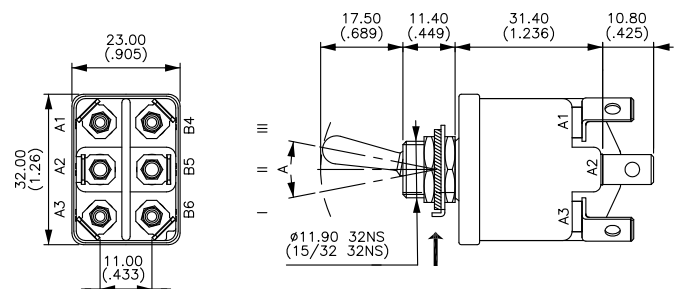

Also available in functions ON-m.OFF and OFF-MOM.

*and** : A2-B4 and A2-B6 = jumper to be wired by the user.

3500 series

High performance toggle switches • environmentally sealed

NORMALIZED QUICK-CONNECT TERMINALS SINGLE POLE



| | Angle of throw (A) | III A2-A3 | II | I A1-A2 |
|---------|--------------------|--------------|-----|------------|
| 3531-03 | 22° | ON | - | OFF |
| 3532-03 | 22° | ON | - | m.OFF |
| 3533-03 | 22° | OFF | - | MOM |
| 3535-03 | 22° | ON | - | MOM |
| 3536-03 | 22° | ON | - | ON |
| 3537-03 | 22° | MOM | OFF | MOM |
| 3538-03 | 30° | ON | OFF | MOM |
| 3539-03 | 30° | ON | OFF | ON |

→ KEYWAY

Shown with standard lever

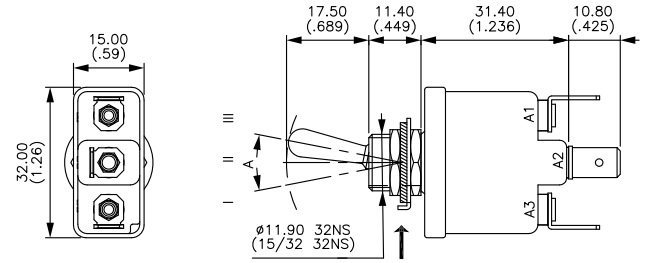

NORMALIZED QUICK-CONNECT TERMINALS DOUBLE POLE



| | Angle of throw (A) | III A2-A3 B5-B6 | II *A3-B5 **A1-B5 | I A1-A2 B5-B4 |
|---------|--------------------|-----------------------|-------------------------|---------------------|
| 3541-03 | 22° | ON | - | OFF |
| 3544-13 | 22° | ON | ON* | ON |
| 3544-23 | 22° | ON | ON* | MOM |
| 3544-33 | 22° | MOM | ON* | MOM |
| 3545-03 | 22° | ON | - | MOM |
| 3546-03 | 22° | ON | - | ON |
| 3547-03 | 22° | MOM | OFF | MOM |
| 3548-03 | 30° | ON | OFF | MOM |
| 3549-03 | 30° | ON | OFF | ON |

→ KEYWAY

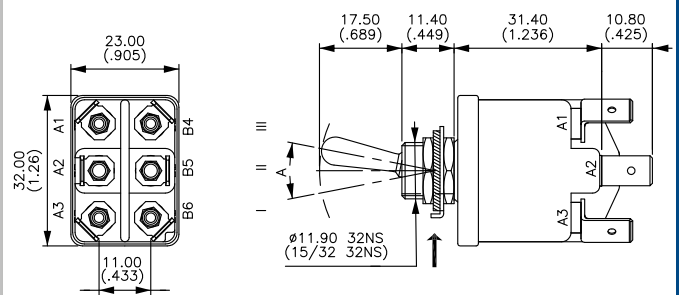

Also available in functions ON-m.OFF and OFF-MOM.

*and**: A2-B4 and A2-B6 = jumper to be wired by the user.

LEVER STYLES

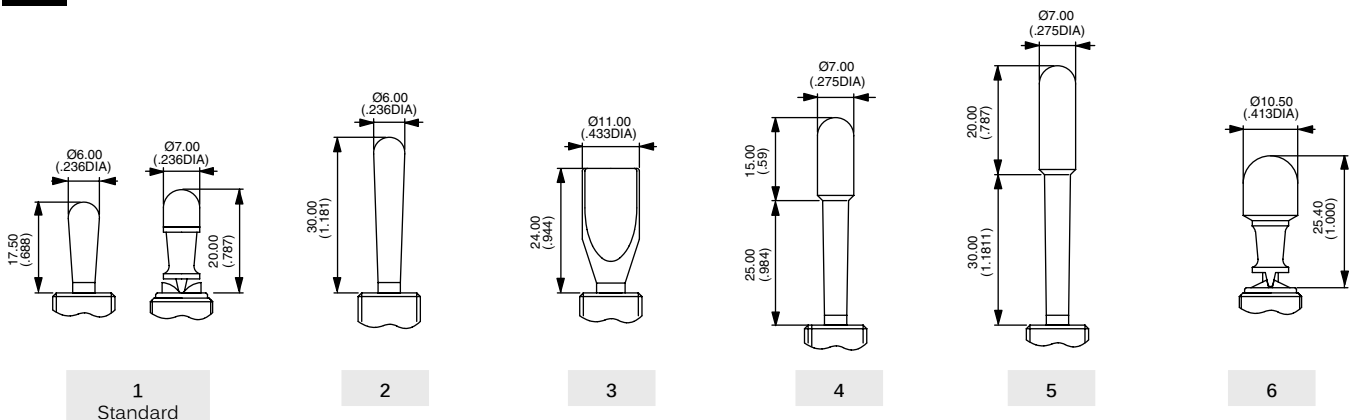

3500 series

High performance toggle switches • environmentally sealed

LEVER FINISH



- N Bright nickel
- B Satin chrome
- G* Black
- F* Black with fluorescent tip (available with lever type 1 only)
- C Painted or anodized (for locking lever only)

* Black finish on bushing too.

LOCKING LEVER STYLES



- 0 No locking
- A Locked in 3 positions. For functions 4-1, 4-4 and 9-0.
- D Locked out of center position. For functions 1-0 and 6-0.
- G Locked in keyway. For functions 1-0 and 6-0.

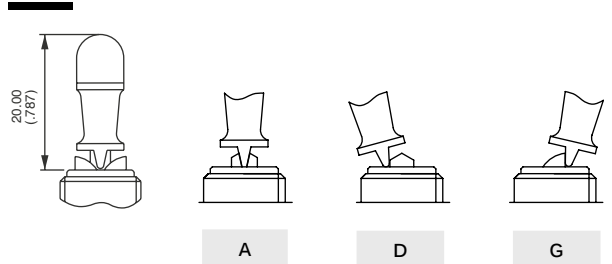

AGENCY APPROVAL



- 0 None
- 1 CECC

MOUNTING ACCESSORIES



- 0 For NON-SEALED mounting (panel cut-out fig. 1, 2 or 3)
2 hex nuts 14 mm (.551) across flats, 1 locking ring U121 or U12, 1 lockwasher U13
Panel thickness : 5 mm (.196) max.
- 2 For SEALED mounting (panel cut-out fig. 2)
2 hex nuts 14 mm (.551) across flats and 1 sealing washer U60
Panel thickness : 4 mm (.157) max.

Special hardware : black cap nut U129. Order separately. See "Hardware" section of website.

LOCKING LEVER SPECIAL FINISH



- (blank) None
 - P5 Painted yellow
 - A6 Anodized red
- Order with lever finish type C.
Other colors on request.



Компания «ЭлектроПласт» предлагает заключение долгосрочных отношений при поставках импортных электронных компонентов на взаимовыгодных условиях!

Наши преимущества:

- Оперативные поставки широкого спектра электронных компонентов отечественного и импортного производства напрямую от производителей и с крупнейших мировых складов;
- Поставка более 17-ти миллионов наименований электронных компонентов;
- Поставка сложных, дефицитных, либо снятых с производства позиций;
- Оперативные сроки поставки под заказ (от 5 рабочих дней);
- Экспресс доставка в любую точку России;
- Техническая поддержка проекта, помощь в подборе аналогов, поставка прототипов;
- Система менеджмента качества сертифицирована по Международному стандарту ISO 9001;
- Лицензия ФСБ на осуществление работ с использованием сведений, составляющих государственную тайну;
- Поставка специализированных компонентов (Xilinx, Altera, Analog Devices, Intersil, Interpoint, Microsemi, Aeroflex, Peregrine, Syfer, Eurofarad, Texas Instrument, Miteq, Cobham, E2V, MA-COM, Hittite, Mini-Circuits, General Dynamics и др.);

Помимо этого, одним из направлений компании «ЭлектроПласт» является направление «Источники питания». Мы предлагаем Вам помощь Конструкторского отдела:

- Подбор оптимального решения, техническое обоснование при выборе компонента;
- Подбор аналогов;
- Консультации по применению компонента;
- Поставка образцов и прототипов;
- Техническая поддержка проекта;
- Защита от снятия компонента с производства.



Как с нами связаться

Телефон: 8 (812) 309 58 32 (многоканальный)

Факс: 8 (812) 320-02-42

Электронная почта: org@eplast1.ru

Адрес: 198099, г. Санкт-Петербург, ул. Калинина, дом 2, корпус 4, литера А.