

SUCCESSIVE DETECTION LOG VIDEO AMPLIFIER (SDLVA) 1 - 20 GHz



Typical Applications

The HMC-C088 is ideal for:

- EW, ELINT & IFM Receivers
- DF Radar Systems
- ECM Systems
- Broadband Test & Measurement
- Power Measurement & Control Circuits
- Military & Space Applications

Functional Diagram

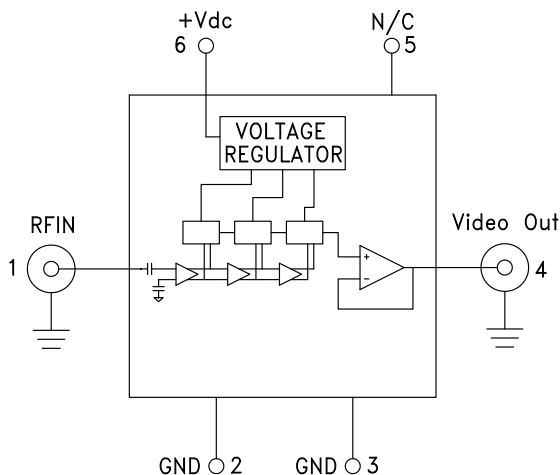

Electrical Specifications, $T_A = +25^\circ\text{C}$ $V_{dc} = +12\text{V}$

Parameter	Conditions	Typ.	Units
Input Frequency Range		1 - 20	GHz
Frequency Flatness	$P_{in} = -30\text{ dBm}$	± 2	dB
Log Linearity	$P_{in} = -50\text{ dBm}$ to $+0\text{ dBm}$	± 1	dBm
Log Linearity over Temperature	-55 to $+85^\circ\text{C}$, $P_{in} = -30\text{ dBm}$	± 1	dB
Minimum Logging Range	to $\pm 3\text{ dB}$ error	-54	dBm
Maximum Logging Range	to $\pm 3\text{ dB}$ error	+5	dBm
Input Return Loss		9	dB
Log Video Minimum Output Voltage		0.9	V

Features

- 1 to 20 GHz Operation
- High Logging Range: 59 dB
- Output Frequency Flatness: $\pm 2\text{ dB}$
- Internal Voltage Regulation
- Fast Rise/Fall Times: 2/7 ns
- Hermetically Sealed Module
- Single Positive Supply: +7V to +16V
- -55°C to $+85^\circ\text{C}$ Operating Temperature

General Description

The HMC-C088 is a Successive Detection Log Video Amplifier (SDLVA) which operates from 1 to 20 GHz. The HMC-C088 provides a logging range of 59 dB.

This product comes standard with two female SMA field replaceable connectors but can also be used with blind mate SMP connectors or as a drop-in module. The package size measures 1.086 x 0.85 x 0.23" (27.58 x 21.6 x 5.84 mm) making it ideal for environmentally robust applications where space is limited.

The HMC-C088 has an integrated voltage regulator that allows the SDLVA to operate from a single supply between +7 and +16V without any appreciable change in performance.

SUCCESSIVE DETECTION LOG VIDEO AMPLIFIER (SDLVA) 1 - 20 GHz

Electrical Specifications, (continued)

Parameter	Conditions	Typ.	Units
Log Video Maximum Output Voltage		1.5	V
Log Video Output Rise Time	Pin = -20 dBm, 10% to 90%	2	ns
Log Video Output Fall Time	Pin = -20 dBm, 90% to 10%	7	ns
Vdc Voltage Range	7 - 16	12	V
Log Video Recovery Time	-50 dBm to 0 dBm	21	ns
Log Video Output Slope		14	mV/dB
Log Video Output Slope Variation over Temperature	@ 10 GHz	5	$\mu\text{V}/\text{dB}^\circ\text{C}$
Log Video Propagation Delay		3	ns
Supply Current (Idc)		86	mA

Error Flatness vs. Input Power Over Frequency

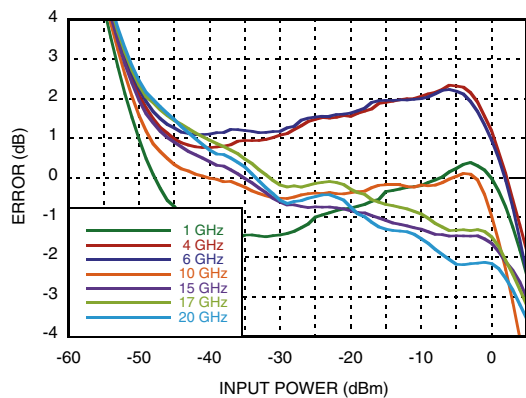

X-Band Error Flatness vs. Input Power Over Frequency

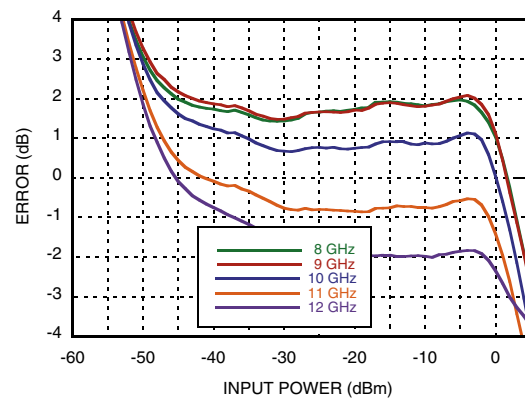

VIDEO OUT & Error vs. Input Power, Fin= 1 GHz

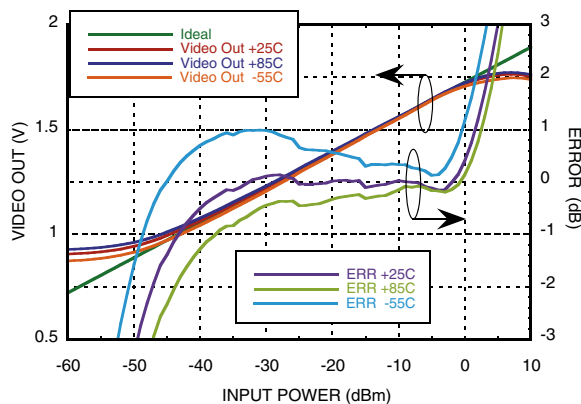

VIDEO OUT & Error vs. Input Power, Fin= 4 GHz

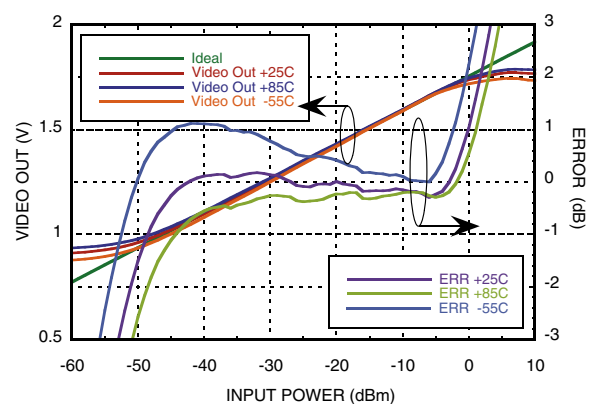

**SUCCESSIVE DETECTION LOG VIDEO AMPLIFIER (SDLVA)
1 - 20 GHz**

SDLVAS - CONNECTORIZED

VIDEO OUT & Error vs. Input Power, F_{in} = 6 GHz

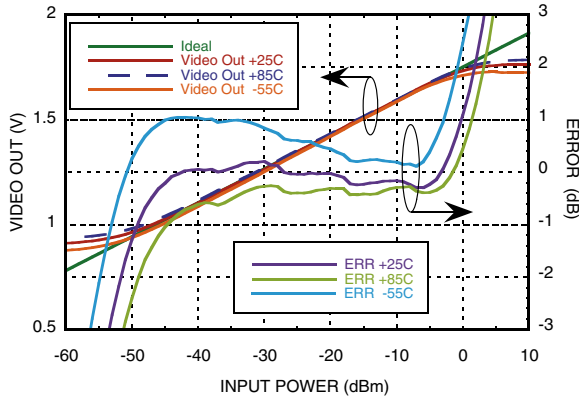

VIDEO OUT & Error vs. Input Power, F_{in} = 10 GHz

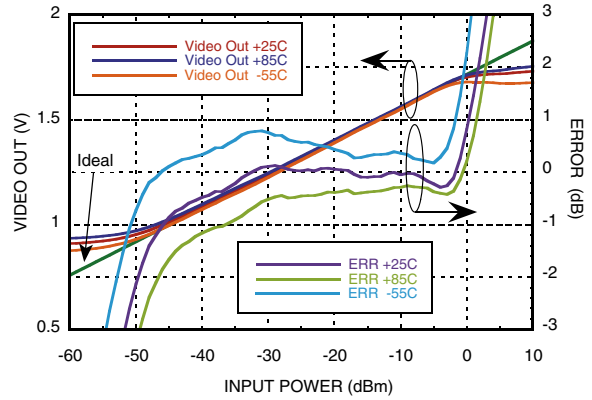

VIDEO OUT vs. Error vs. Input Power, F_{in} = 12 GHz

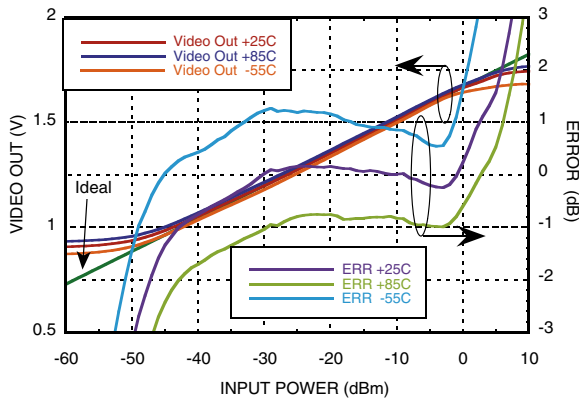

VIDEO OUT & Error vs. Input Power, F_{in} = 15 GHz

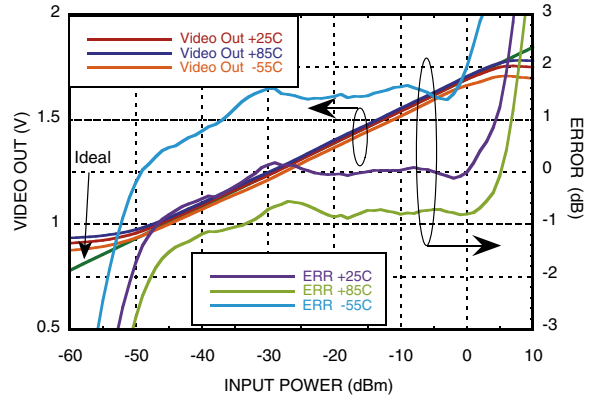

VIDEO OUT & Error vs. Input Power, F_{in} = 17 GHz

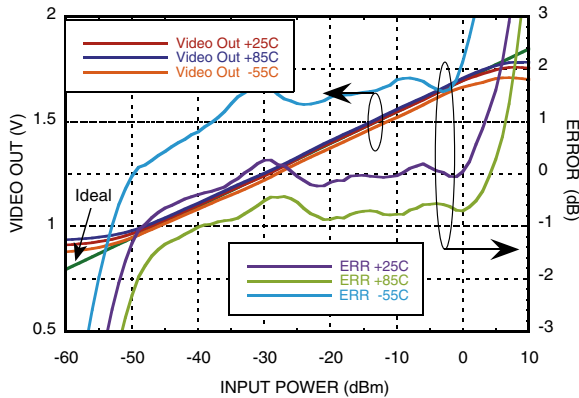

VIDEO OUT & Error vs. Input Power, F_{in} = 20 GHz

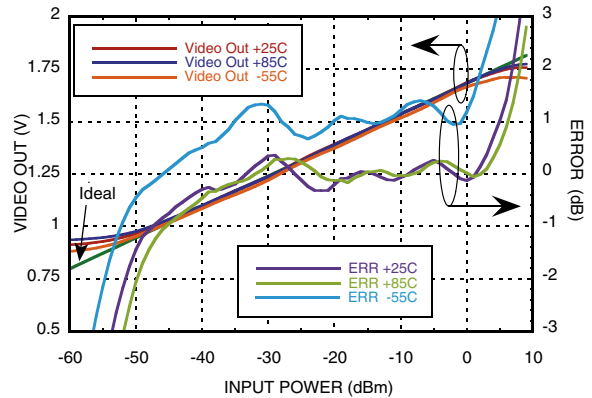

SUCCESSIVE DETECTION LOG VIDEO AMPLIFIER (SDLVA) 1 - 20 GHz

**VIDEO OUT vs. Frequency
Over Input Power & Temperature**

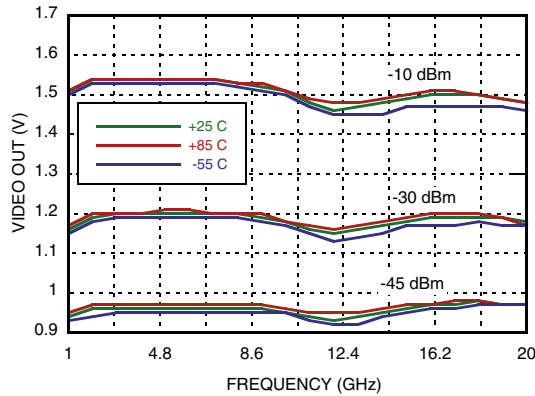

Input Return Loss vs. Frequency

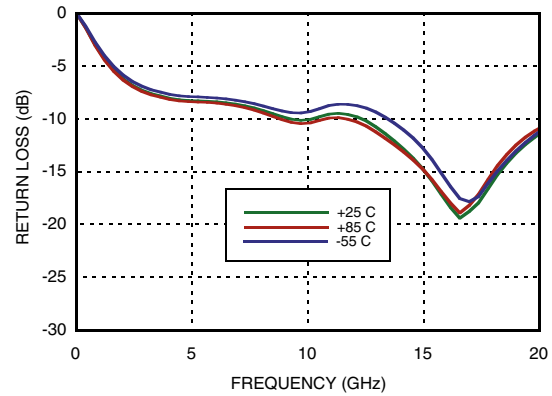

Rise Time @ 10 GHz @ -20 dBm

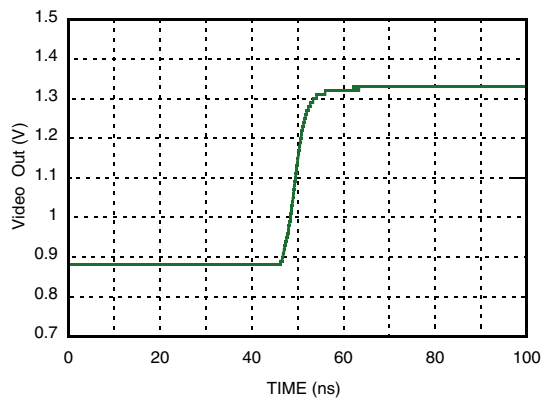

Fall Time @ 10 GHz @ -20 dBm

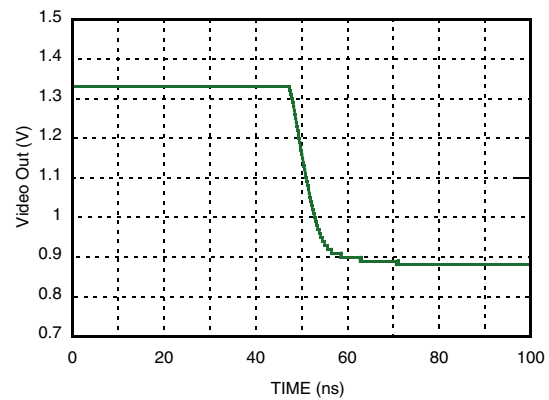

Absolute Maximum Ratings

I _{cc}	100 mA
Input Signal Amplitude	18 dBm
Junction Temperature	125 °C
Continuous P _{diss} (T=85°C) Derate 59 mW/°C above 85°C	1.6 W
Thermal Resistance (R _{th}) (junction to package bottom)	17 °C/W
V _{dc} Max	+16V
Storage Temperature	-65 to +150 °C
Operating Temperature	-55 to +85 °C
ESD Sensitivity (HBM)	Class 1A



**ELECTROSTATIC SENSITIVE DEVICE
OBSERVE HANDLING PRECAUTIONS**

SUCCESSIVE DETECTION LOG VIDEO AMPLIFIER (SDLVA) 1 - 20 GHz

Outline Drawing

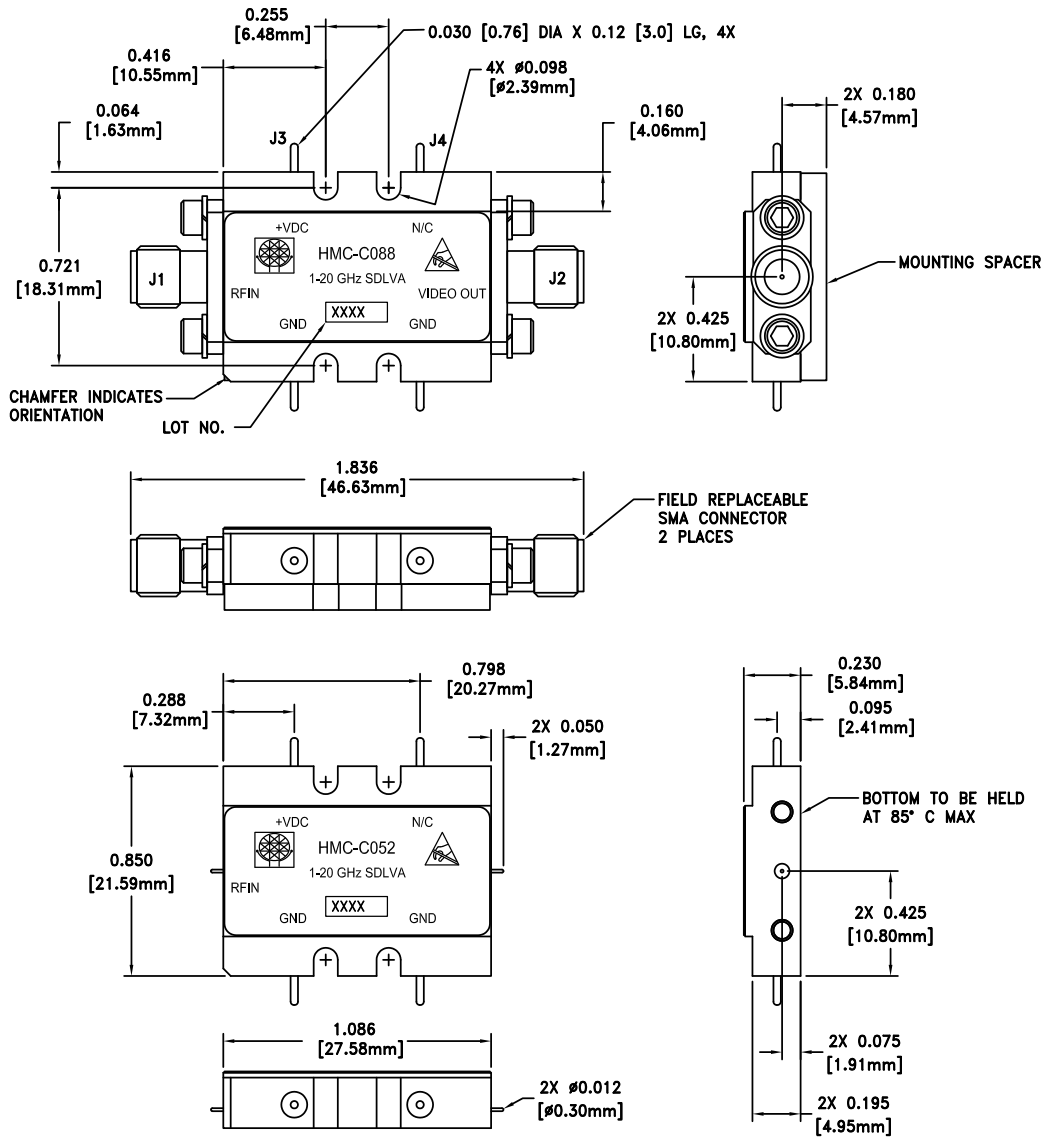

Package Information

Package Type	C-10
Package Weight ^[1]	16.7 gms ^[2]
Spacer Weight	3.3 gms ^[2]

[1] Includes the connectors

[2] ±1 gms Tolerance



NOTES:

NOTES:

1. PACKAGE, LEADS, COVER MATERIAL: KOVAR™
2. PLATING: GOLD PLATE OVER NICKEL PLATE.
3. MOUNTING SPACER: NICKEL PLATED ALUMINUM.
4. ALL DIMENSIONS ARE IN INCHES [MILLIMETERS].
5. TOLERANCES:
 - 5.1 .XX = ±.02
 - 5.2 .XXX = ±.010
6. MARK LOT NUMBER ON 0.080 X 0.250 LABEL WHERE SHOWN WITH .030" MIN TEXT HEIGHT.
7. MOUNTING SPACER PART NUMBER 126216.

SUCCESSIVE DETECTION LOG VIDEO AMPLIFIER (SDLVA) 1 - 20 GHz

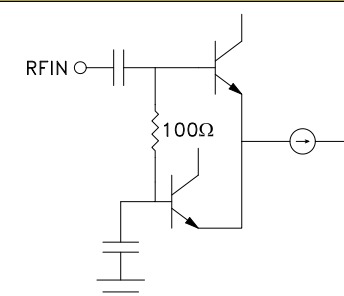
Pin Descriptions

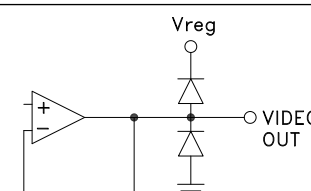
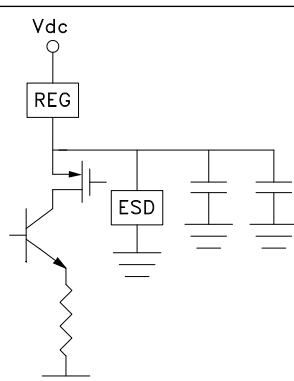
Pin Number	Function	Description	Interface Schematic
1	RFIN	RF Input pin.	
2, 3	GND	These pins must be connected to a high quality RF/DC ground.	
4	VIDEO OUT	Video Out is a voltage that is proportional to the log of the Input Power.	
5	N/C	The pins are not connected internally; however, all data shown herein was measured with these pins connected to RF/DC ground externally.	
6	Vdc	Bias Supply pin.	



Компания «ЭлектроПласт» предлагает заключение долгосрочных отношений при поставках импортных электронных компонентов на взаимовыгодных условиях!

Наши преимущества:

- Оперативные поставки широкого спектра электронных компонентов отечественного и импортного производства напрямую от производителей и с крупнейших мировых складов;
- Поставка более 17-ти миллионов наименований электронных компонентов;
- Поставка сложных, дефицитных, либо снятых с производства позиций;
- Оперативные сроки поставки под заказ (от 5 рабочих дней);
- Экспресс доставка в любую точку России;
- Техническая поддержка проекта, помощь в подборе аналогов, поставка прототипов;
- Система менеджмента качества сертифицирована по Международному стандарту ISO 9001;
- Лицензия ФСБ на осуществление работ с использованием сведений, составляющих государственную тайну;
- Поставка специализированных компонентов (Xilinx, Altera, Analog Devices, Intersil, Interpoint, Microsemi, Aeroflex, Peregrine, Syfer, Eurofarad, Texas Instrument, Miteq, Cobham, E2V, MA-COM, Hittite, Mini-Circuits, General Dynamics и др.);

Помимо этого, одним из направлений компании «ЭлектроПласт» является направление «Источники питания». Мы предлагаем Вам помощь Конструкторского отдела:

- Подбор оптимального решения, техническое обоснование при выборе компонента;
- Подбор аналогов;
- Консультации по применению компонента;
- Поставка образцов и прототипов;
- Техническая поддержка проекта;
- Защита от снятия компонента с производства.



Как с нами связаться

Телефон: 8 (812) 309 58 32 (многоканальный)

Факс: 8 (812) 320-02-42

Электронная почта: org@eplast1.ru

Адрес: 198099, г. Санкт-Петербург, ул. Калинина, дом 2, корпус 4, литера А.