

100-Pin TQFP
Commercial Temp
Industrial Temp

1M x 18, 512K x 32, 512K x 36
18Mb Sync Burst SRAMs

400 MHz–150 MHz
2.5 V or 3.3 V V_{DD}
2.5 V or 3.3 V I/O

Features

- \overline{FT} pin for user-configurable flow through or pipeline operation
- Dual Cycle Deselect (DCD) operation
- 2.5 V or 3.3 V +10%/–10% core power supply
- 2.5 V or 3.3 V I/O supply
- \overline{LBO} pin for Linear or Interleaved Burst mode
- Internal input resistors on mode pins allow floating mode pins
- Default to Interleaved Pipeline mode
- Byte Write (\overline{BW}) and/or Global Write (\overline{GW}) operation
- Internal self-timed write cycle
- Automatic power-down for portable applications
- RoHS-compliant 100-lead TQFP package available

Functional Description

Applications

The GS8160E18/32/36DGT is an 18,874,368-bit high performance synchronous SRAM with a 2-bit burst address counter. Although of a type originally developed for Level 2 Cache applications supporting high performance CPUs, the device now finds application in synchronous SRAM applications, ranging from DSP main store to networking chip set support.

Controls

Addresses, data I/Os, chip enables ($\overline{E1}$, $E2$, $\overline{E3}$), address burst control inputs (\overline{ADSP} , \overline{ADSC} , \overline{ADV}), and write control inputs (\overline{Bx} , \overline{BW} , \overline{GW}) are synchronous and are controlled by a positive-edge-triggered clock input (CK). Output enable (\overline{G}) and power down control (ZZ) are asynchronous inputs. Burst cycles can be initiated with either \overline{ADSP} or \overline{ADSC} inputs. In Burst mode, subsequent burst addresses are generated internally and are controlled by \overline{ADV} . The burst address counter may be configured to count in either linear or

interleave order with the Linear Burst Order (\overline{LBO}) input. The Burst function need not be used. New addresses can be loaded on every cycle with no degradation of chip performance.

Flow Through/Pipeline Reads

The function of the Data Output register can be controlled by the user via the \overline{FT} mode pin (Pin 14). Holding the \overline{FT} mode pin low places the RAM in Flow Through mode, causing output data to bypass the Data Output Register. Holding \overline{FT} high places the RAM in Pipeline mode, activating the rising-edge-triggered Data Output Register.

DCD Pipelined Reads

The GS8160E18/32/36DGT is a DCD (Dual Cycle Deselect) pipelined synchronous SRAM. SCD (Single Cycle Deselect) versions are also available. DCD SRAMs pipeline disable commands to the same degree as read commands. DCD RAMs hold the deselect command for one full cycle and then begin turning off their outputs just after the second rising edge of clock.

Byte Write and Global Write

Byte write operation is performed by using Byte Write enable (\overline{BW}) input combined with one or more individual byte write signals (\overline{Bx}). In addition, Global Write (\overline{GW}) is available for writing all bytes at one time, regardless of the Byte Write control inputs.

Sleep Mode

Low power (Sleep mode) is attained through the assertion (High) of the ZZ signal, or by stopping the clock (CK). Memory data is retained during Sleep mode.

Core and Interface Voltages

The GS8160E18/32/36DGT operates on a 3.3 V or 2.5 V power supply. All input are 3.3 V and 2.5 V compatible. Separate output power (V_{DDQ}) pins are used to decouple output noise from the internal circuits and are 3.3 V and 2.5 V compatible.

Parameter Synopsis

		-400	-375	-333	-250	-200	-150	Unit
Pipeline 3-1-1-1	t_{KQ}	2.5	2.5	2.5	2.5	3.0	3.8	ns
	t_{Cycle}	2.5	2.66	3.3	4.0	5.0	6.7	ns
	Curr (x18)	370	350	310	250	210	185	mA
	Curr (x32/x36)	430	410	365	290	240	200	mA
Flow Through 2-1-1-1	t_{KQ}	4.0	4.2	4.5	5.5	6.5	7.5	ns
	t_{Cycle}	4.0	4.2	4.5	5.5	6.5	7.5	ns
	Curr (x18)	275	265	255	220	205	190	mA
	Curr (x32/x36)	315	300	285	250	225	205	mA

GS8160E32D 100-Pin TQFP Pinout

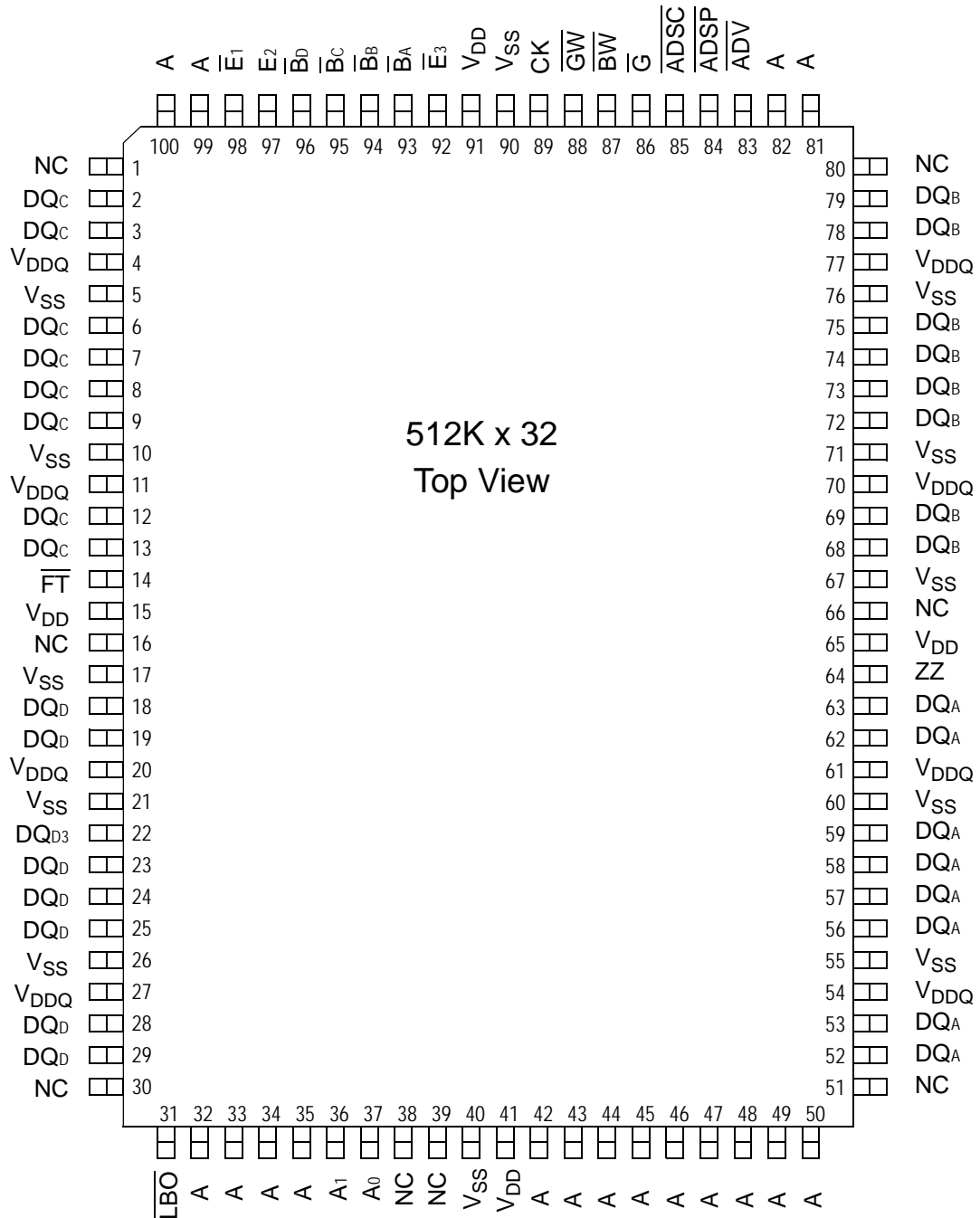

Note:

Pins marked with NC can be tied to either V_{DD} or V_{SS} . These pins can also be left floating.

GS8160E36D 100-Pin TQFP Pinout

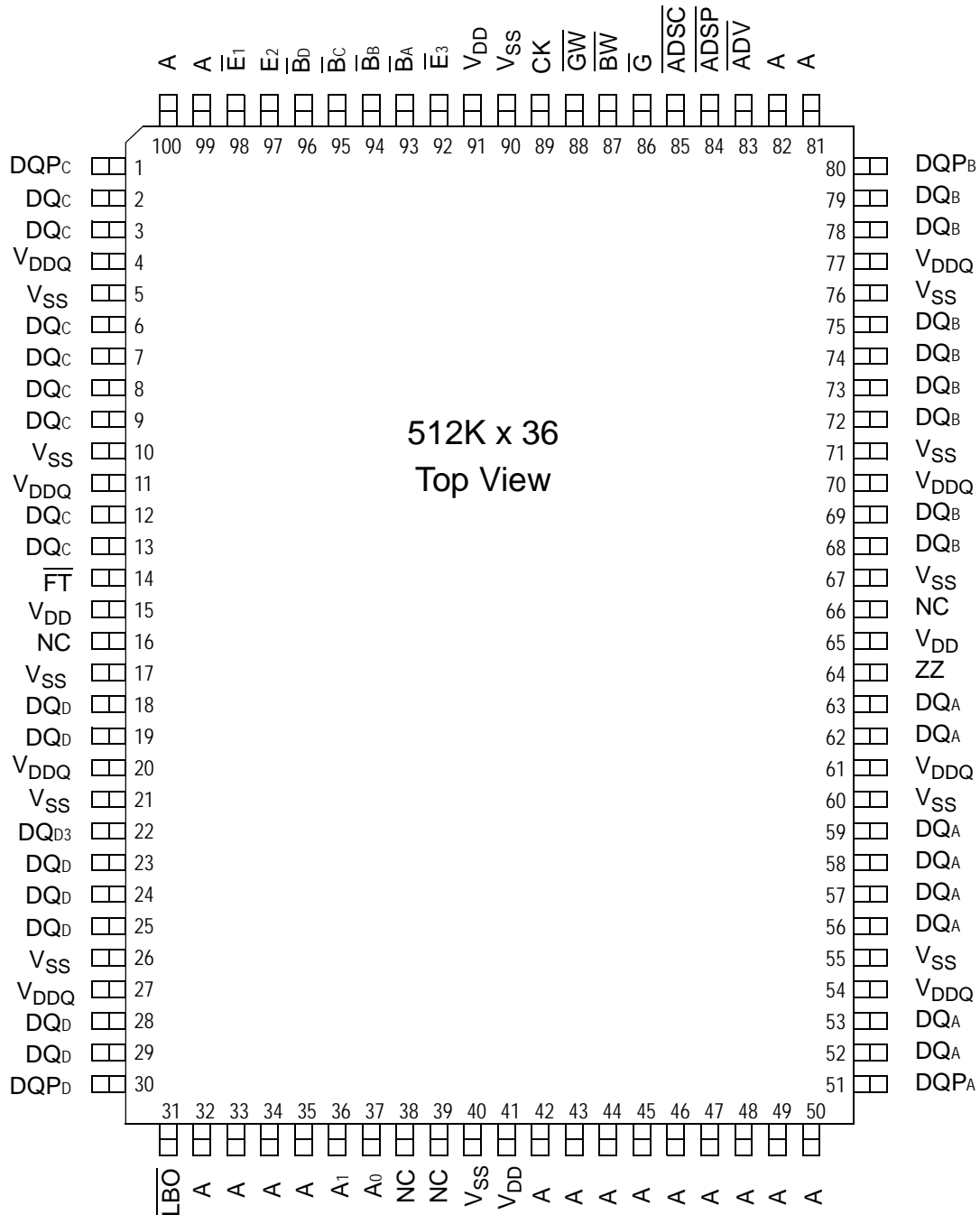

Note:

Pins marked with NC can be tied to either V_{DD} or V_{SS} . These pins can also be left floating.

TQFP Pin Description

Symbol	Type	Description
A ₀ , A ₁	I	Address field LSBs and Address Counter preset Inputs
A	I	Address Inputs
DQ _A DQ _B DQ _C DQ _D	I/O	Data Input and Output pins
\overline{BW}	I	Byte Write—Writes all enabled bytes; active low
$\overline{B_A}$, $\overline{B_B}$	I	Byte Write Enable for DQ _A , DQ _B Data I/Os; active low
$\overline{B_C}$, $\overline{B_D}$	I	Byte Write Enable for DQ _C , DQ _D Data I/Os; active low
CK	I	Clock Input Signal; active high
\overline{GW}	I	Global Write Enable—Writes all bytes; active low
$\overline{E_1}$, $\overline{E_3}$	I	Chip Enable; active low
E ₂	I	Chip Enable; active high
\overline{G}	I	Output Enable; active low
\overline{ADV}	I	Burst address counter advance enable; active low
\overline{ADSP} , \overline{ADSC}	I	Address Strobe (Processor, Cache Controller); active low
ZZ	I	Sleep Mode control; active high
\overline{FT}	I	Flow Through or Pipeline mode; active low
\overline{LBO}	I	Linear Burst Order mode; active low
V _{DD}	I	Core power supply
V _{SS}	I	I/O and Core Ground
V _{DDQ}	I	Output driver power supply
NC		No Connect

GS8160E18/32/36D Block Diagram

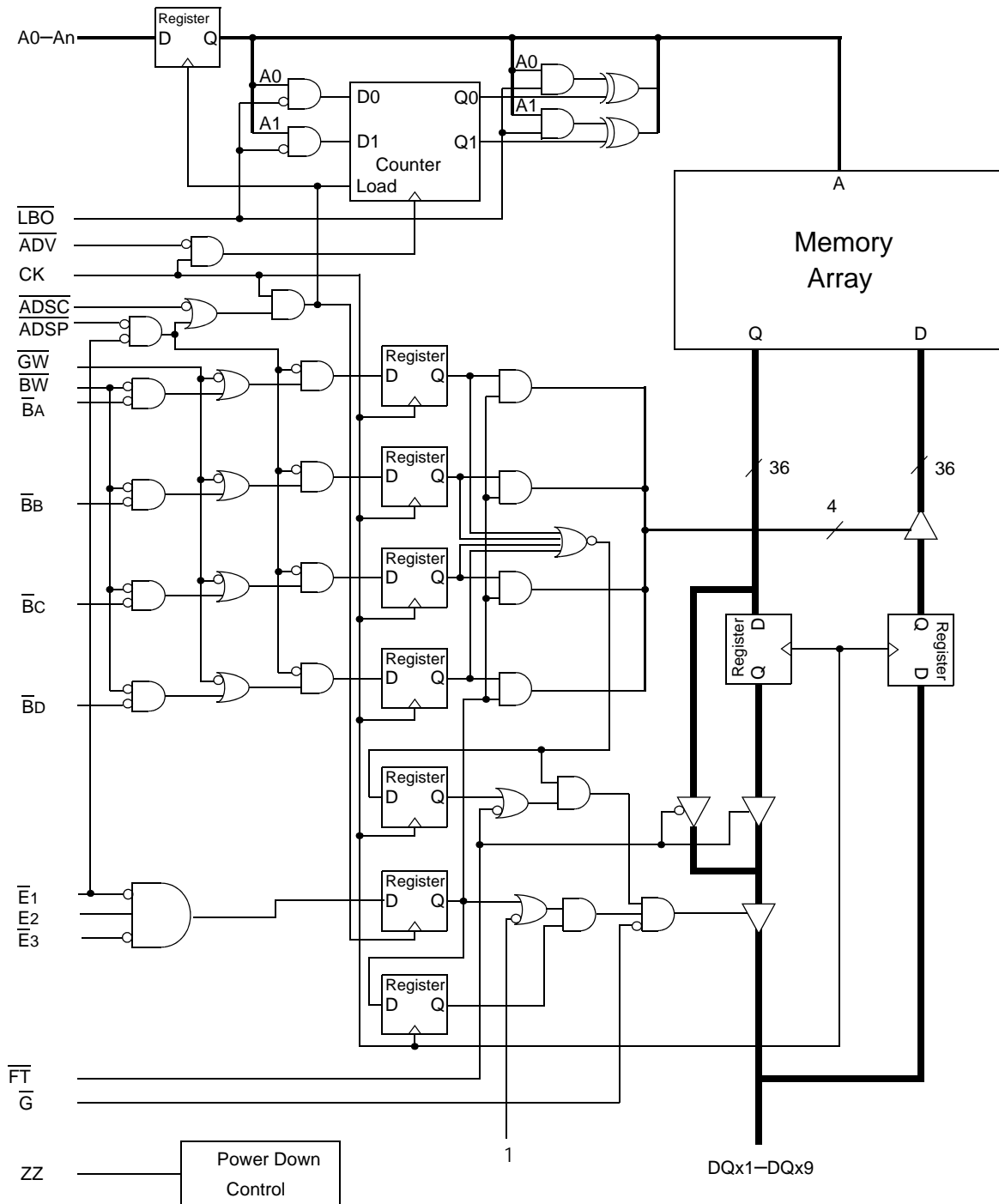

Note: Only x36 version shown for simplicity.

Mode Pin Functions

Mode Name	Pin Name	State	Function
Burst Order Control	$\overline{\text{LBO}}$	L	Linear Burst
		H	Interleaved Burst
Output Register Control	$\overline{\text{FT}}$	L	Flow Through
		H or NC	Pipeline
Power Down Control	ZZ	L or NC	Active
		H	Standby, $I_{DD} = I_{SB}$

Note:

There is a pull-up device on the $\overline{\text{FT}}$ pin and a pull-down device on the ZZ pin, so this input pin can be unconnected and the chip will operate in the default states as specified in the above tables.

Burst Counter Sequences

Linear Burst Sequence

	A[1:0]	A[1:0]	A[1:0]	A[1:0]
1st address	00	01	10	11
2nd address	01	10	11	00
3rd address	10	11	00	01
4th address	11	00	01	10

Note:

The burst counter wraps to initial state on the 5th clock.

Interleaved Burst Sequence

	A[1:0]	A[1:0]	A[1:0]	A[1:0]
1st address	00	01	10	11
2nd address	01	00	11	10
3rd address	10	11	00	01
4th address	11	10	01	00

Note:

The burst counter wraps to initial state on the 5th clock.

Byte Write Truth Table

Function	\overline{GW}	\overline{BW}	\overline{BA}	\overline{BB}	\overline{BC}	\overline{BD}	Notes
Read	H	H	X	X	X	X	1
Write No Bytes	H	L	H	H	H	H	1
Write byte a	H	L	L	H	H	H	2, 3
Write byte b	H	L	H	L	H	H	2, 3
Write byte c	H	L	H	H	L	H	2, 3, 4
Write byte d	H	L	H	H	H	L	2, 3, 4
Write all bytes	H	L	L	L	L	L	2, 3, 4
Write all bytes	L	X	X	X	X	X	

Notes:

1. All byte outputs are active in read cycles regardless of the state of Byte Write Enable inputs, \overline{BA} , \overline{BB} , \overline{BC} and/or \overline{BD} .
2. Byte Write Enable inputs \overline{BA} , \overline{BB} , \overline{BC} and/or \overline{BD} may be used in any combination with \overline{BW} to write single or multiple bytes.
3. All byte I/Os remain High-Z during all write operations regardless of the state of Byte Write Enable inputs.
4. Bytes "c" and "d" are only available on the x32 and x36 versions.

Synchronous Truth Table

Operation	Address Used	State Diagram Key	\bar{E}_1	E2	\bar{E}_3	\overline{ADSP}	\overline{ADSC}	\overline{ADV}	\bar{W}	DQ ³
Deselect Cycle, Power Down	None	X	L	X	H	X	L	X	X	High-Z
Deselect Cycle, Power Down	None	X	L	L	X	X	L	X	X	High-Z
Deselect Cycle, Power Down	None	X	L	X	H	L	X	X	X	High-Z
Deselect Cycle, Power Down	None	X	L	L	X	L	X	X	X	High-Z
Deselect Cycle, Power Down	None	X	H	X	X	X	L	X	X	High-Z
Read Cycle, Begin Burst	External	R	L	H	L	L	X	X	X	Q
Read Cycle, Begin Burst	External	R	L	H	L	H	L	X	F	Q
Write Cycle, Begin Burst	External	W	L	H	L	H	L	X	T	D
<i>Read Cycle, Continue Burst</i>	<i>Next</i>	<i>CR</i>	<i>X</i>	<i>X</i>	<i>X</i>	<i>H</i>	<i>H</i>	<i>L</i>	<i>F</i>	<i>Q</i>
Read Cycle, Continue Burst	Next	CR	H	X	X	X	H	L	F	Q
<i>Write Cycle, Continue Burst</i>	<i>Next</i>	<i>CW</i>	<i>X</i>	<i>X</i>	<i>X</i>	<i>H</i>	<i>H</i>	<i>L</i>	<i>T</i>	<i>D</i>
Write Cycle, Continue Burst	Next	CW	H	X	X	X	H	L	T	D
Read Cycle, Suspend Burst	Current		X	X	X	H	H	H	F	Q
Read Cycle, Suspend Burst	Current		H	X	X	X	H	H	F	Q
Write Cycle, Suspend Burst	Current		X	X	X	H	H	H	T	D
Write Cycle, Suspend Burst	Current		H	X	X	X	H	H	T	D

Notes:

1. X = Don't Care, H = High, L = Low
2. E = T (True) if E₂ = 1 and $\bar{E}_1 = \bar{E}_3 = 0$; E = F (False) if E₂ = 0 or $\bar{E}_1 = 1$ or $\bar{E}_3 = 1$
3. \bar{W} = T (True) and F (False) is defined in the Byte Write Truth Table preceding.
4. \bar{G} is an asynchronous input. \bar{G} can be driven high at any time to disable active output drivers. \bar{G} low can only enable active drivers (shown as "Q" in the Truth Table above).
5. All input combinations shown above are tested and supported. Input combinations shown in gray boxes need not be used to accomplish basic synchronous or synchronous burst operations and may be avoided for simplicity.
6. Tying \overline{ADSP} high and \overline{ADSC} low allows simple non-burst synchronous operations. See **BOLD** items above.
7. Tying \overline{ADSP} high and \overline{ADV} low while using \overline{ADSC} to load new addresses allows simple burst operations. See *ITALIC* items above.

Simplified State Diagram



Notes:

1. The diagram shows only supported (tested) synchronous state transitions. The diagram presumes \overline{G} is tied low.
2. The upper portion of the diagram assumes active use of only the Enable ($\overline{E1}$) and Write (\overline{BA} , \overline{BB} , \overline{BC} , \overline{BD} , \overline{BW} , and \overline{GW}) control inputs, and that \overline{ADSP} is tied high and \overline{ADSC} is tied low.
3. The upper and lower portions of the diagram together assume active use of only the Enable, Write, and \overline{ADSC} control inputs, and assumes \overline{ADSP} is tied high and \overline{ADV} is tied low.

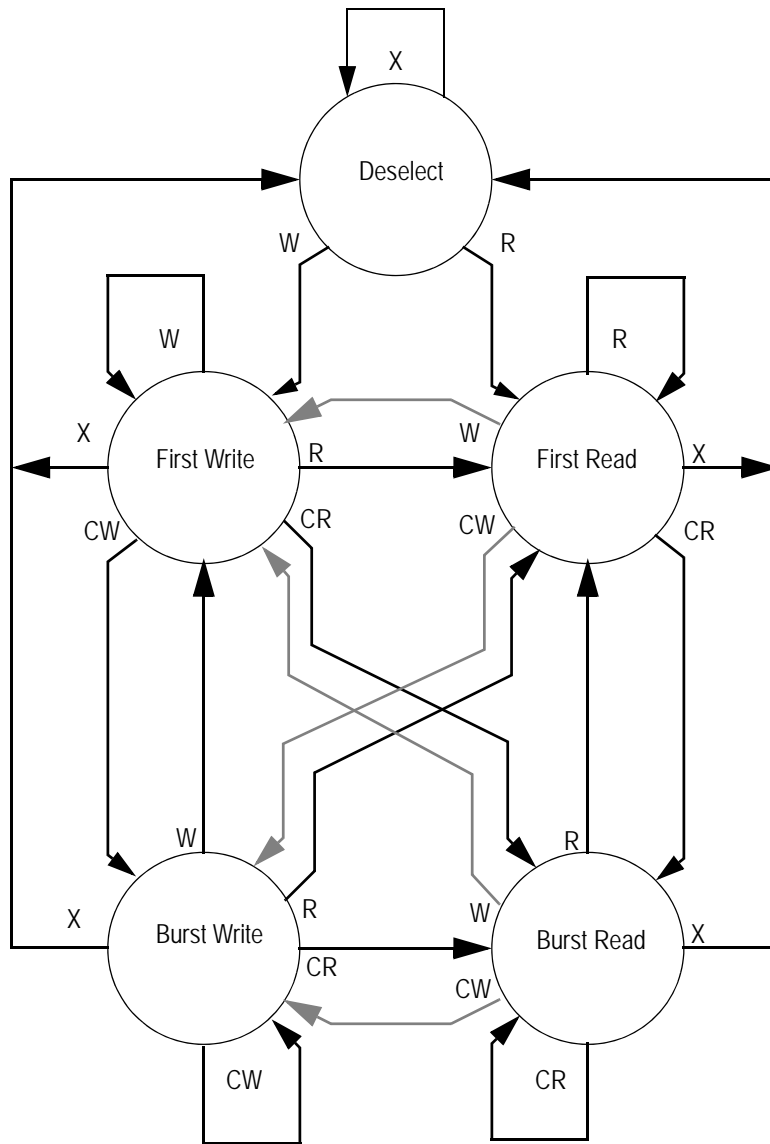
Simplified State Diagram with \overline{G}

Notes:

1. The diagram shows supported (tested) synchronous state transitions plus supported transitions that depend upon the use of \overline{G} .
2. Use of "Dummy Reads" (Read Cycles with \overline{G} High) may be used to make the transition from Read cycles to Write cycles without passing through a Deselect cycle. Dummy Read cycles increment the address counter just like normal read cycles.
3. Transitions shown in gray tone assume \overline{G} has been pulsed high long enough to turn the RAM's drivers off and for incoming data to meet Data Input Set Up Time.

Absolute Maximum Ratings

(All voltages reference to V_{SS})

Symbol	Description	Value	Unit
V_{DD}	Voltage on V_{DD} Pins	-0.5 to 4.6	V
V_{DDQ}	Voltage in V_{DDQ} Pins	-0.5 to V_{DD}	V
$V_{I/O}$	Voltage on I/O Pins	-0.5 to $V_{DD} + 0.5$ (≤ 4.6 V max.)	V
V_{IN}	Voltage on Other Input Pins	-0.5 to $V_{DD} + 0.5$ (≤ 4.6 V max.)	V
I_{IN}	Input Current on Any Pin	+/-20	mA
I_{OUT}	Output Current on Any I/O Pin	+/-20	mA
P_D	Package Power Dissipation	1.5	W
T_{STG}	Storage Temperature	-55 to 125	°C
T_{BIAS}	Temperature Under Bias	-55 to 125	°C

Note:

Permanent damage to the device may occur if the Absolute Maximum Ratings are exceeded. Operation should be restricted to Recommended Operating Conditions. Exposure to conditions exceeding the Absolute Maximum Ratings, for an extended period of time, may affect reliability of this component.

Power Supply Voltage Ranges

Parameter	Symbol	Min.	Typ.	Max.	Unit
3.3 V Supply Voltage	V_{DD3}	3.0	3.3	3.6	V
2.5 V Supply Voltage	V_{DD2}	2.3	2.5	2.7	V
3.3 V V_{DDQ} I/O Supply Voltage	V_{DDQ3}	3.0	3.3	3.6	V
2.5 V V_{DDQ} I/O Supply Voltage	V_{DDQ2}	2.3	2.5	2.7	V

V_{DD3} Range Logic Levels

Parameter	Symbol	Min.	Typ.	Max.	Unit
Input High Voltage	V_{IH}	2.0	—	$V_{DD} + 0.3$	V
Input Low Voltage	V_{IL}	-0.3	—	0.8	V

Notes:

- V_{IH} (max) must be met for any instantaneous value of V_{DD} .
- V_{DD} needs to power-up before or at the same time as V_{DDQ} to make sure V_{IH} (max) is not exceeded.

V_{DD2} Range Logic Levels

Parameter	Symbol	Min.	Typ.	Max.	Unit
Input High Voltage	V _{IH}	0.6*V _{DD}	—	V _{DD} + 0.3	V
Input Low Voltage	V _{IL}	-0.3	—	0.3*V _{DD}	V

Notes:

- V_{IH} (max) must be met for any instantaneous value of V_{DD}.
- V_{DD} needs to power-up before or at the same time as V_{DD0} to make sure V_{IH} (max) is not exceeded.

Operating Temperature

Parameter	Symbol	Min.	Typ.	Max.	Unit
Junction Temperature (Commercial Range Versions)	T _J	0	25	85	°C
Junction Temperature (Industrial Range Versions)*	T _J	-40	25	100	°C

Note:

* The part numbers of Industrial Temperature Range versions end with the character "I". Unless otherwise noted, all performance specifications quoted are evaluated for worst case in the temperature range marked on the device.

Thermal Impedance

Package	Test PCB Substrate	θ JA (C°/W) Airflow = 0 m/s	θ JA (C°/W) Airflow = 1 m/s	θ JA (C°/W) Airflow = 2 m/s	θ JB (C°/W)	θ JC (C°/W)
100 TQFP	4-layer	35.7	31.0	29.4	27.0	8.4

Notes:

- Thermal Impedance data is based on a number of samples from multiple lots and should be viewed as a typical number.
- The characteristics of the test fixture PCB influence reported thermal characteristics of the device. Be advised that a good thermal path to the PCB can result in cooling or heating of the RAM depending on PCB temperature.

Undershoot Measurement and Timing

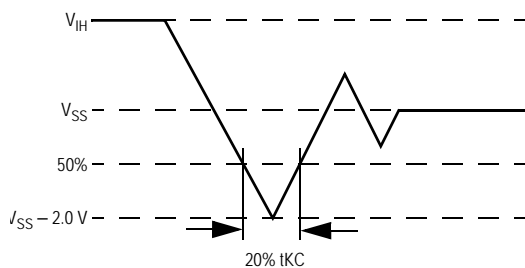

Note:

Input Under/overshoot voltage must be $-2\text{ V} > V_i < V_{DDn} + 2\text{ V}$ not to exceed 4.6 V maximum, with a pulse width not to exceed 20% t_{KC}.

Overshoot Measurement and Timing

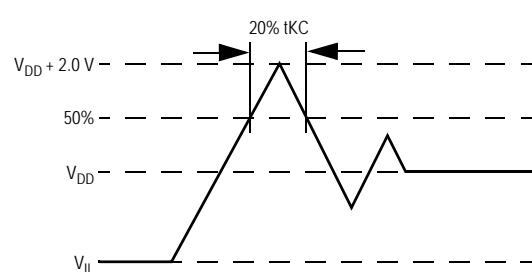

Capacitance

($T_A = 25^\circ\text{C}$, $f = 1\text{ MHz}$, $V_{DD} = 2.5\text{ V}$)

Parameter	Symbol	Test conditions	Typ.	Max.	Unit
Input Capacitance	C_{IN}	$V_{IN} = 0\text{ V}$	4	5	pF
Input/Output Capacitance	$C_{I/O}$	$V_{OUT} = 0\text{ V}$	6	7	pF

Note:

These parameters are sample tested.

AC Test Conditions

Parameter	Conditions
Input high level	$V_{DD} - 0.2\text{ V}$
Input low level	0.2 V
Input slew rate	1 V/ns
Input reference level	$V_{DD}/2$
Output reference level	$V_{DDQ}/2$
Output load	Fig. 1

Notes:

1. Include scope and jig capacitance.
2. Test conditions as specified with output loading as shown in Fig. 1 unless otherwise noted.
3. Device is deselected as defined by the Truth Table.



DC Electrical Characteristics

Parameter	Symbol	Test Conditions	Min	Max
Input Leakage Current (except mode pins)	I_{IL}	$V_{IN} = 0$ to V_{DD}	-1 μ A	1 μ A
ZZ Input Current	I_{IN1}	$V_{DD} \geq V_{IN} \geq V_{IH}$ $0 V \leq V_{IN} \leq V_{IH}$	-1 μ A -1 μ A	1 μ A 100 μ A
\overline{FT} Input Current	I_{IN2}	$V_{DD} \geq V_{IN} \geq V_{IL}$ $0 V \leq V_{IN} \leq V_{IL}$	-100 μ A -1 μ A	1 μ A 1 μ A
Output Leakage Current	I_{OL}	Output Disable, $V_{OUT} = 0$ to V_{DD}	-1 μ A	1 μ A
Output High Voltage	V_{OH2}	$I_{OH} = -8$ mA, $V_{DDQ} = 2.375$ V	1.7 V	—
Output High Voltage	V_{OH3}	$I_{OH} = -8$ mA, $V_{DDQ} = 3.135$ V	2.4 V	—
Output Low Voltage	V_{OL}	$I_{OL} = 8$ mA	—	0.4 V

Operating Currents

Parameter	Test Conditions	Mode	Symbol	-400		-375		-333		-250		-200		-150		Unit		
				0 to 70°C	-40 to 85°C	0 to 70°C	-40 to 85°C	0 to 70°C	-40 to 85°C	0 to 70°C	-40 to 85°C	0 to 70°C	-40 to 85°C	0 to 70°C	-40 to 85°C			
Operating Current	Device Selected; All other inputs $\geq V_{IH}$ or $\leq V_{IL}$ Output open	(x32/ x36)	Pipeline	I_{DD}	365	385	350	370	315	335	270	210	180	200	200	mA		
			Flow Through	I_{DDQ}	65	65	60	60	50	50	40	30	30	20	20			
		(x18)	Pipeline	I_{DD}	280	300	270	290	260	280	230	250	210	190	210	210	mA	
			Flow Through	I_{DDQ}	35	35	30	30	25	25	20	20	15	15	15	15		
		Standby Current	$ZZ \geq V_{DD} - 0.2 V$	—	Pipeline	I_{DD}	335	355	320	340	285	305	250	195	170	190	190	mA
					Flow Through	I_{DDQ}	35	35	30	30	25	25	20	20	15	15	15	
Deselect Current	Device Deselected; All other inputs $\geq V_{IH}$ or $\leq V_{IL}$	—	Pipeline	I_{SB}	50	70	50	70	50	70	50	50	50	70	70	mA		
			Flow Through	I_{SB}	50	70	50	70	50	70	50	70	50	70	70			

Notes:

1. I_{DD} and I_{DDQ} apply to any combination of V_{DD3} , V_{DD2} , V_{DDQ3} , and V_{DDQ2} operation.
2. All parameters listed are worst case scenario.

AC Electrical Characteristics

	Parameter	Symbol	-400		-375		-333		-250		-200		-150		Unit
			Min	Max	Min	Max	Min	Max	Min	Max	Min	Max	Min	Max	
Pipeline	Clock Cycle Time	t _{KC}	2.5	—	2.66	—	3.3	—	4.0	—	5.0	—	6.7	—	ns
	Clock to Output Valid	t _{KQ}	—	2.5	—	2.5	—	2.5	—	2.5	—	3.0	—	3.8	ns
	Clock to Output Invalid	t _{KQX}	1.5	—	1.5	—	1.5	—	1.5	—	1.5	—	1.5	—	ns
	Clock to Output in Low-Z	t _{LZ} ¹	1.5	—	1.5	—	1.5	—	1.5	—	1.5	—	1.5	—	ns
	Setup time	t _S	0.9	—	0.9	—	1.0	—	1.2	—	1.4	—	1.5	—	ns
	Hold time	t _H	0.1	—	0.1	—	0.1	—	0.2	—	0.4	—	0.5	—	ns
Flow Through	Clock Cycle Time	t _{KC}	4.0	—	4.2	—	4.5	—	5.5	—	6.5	—	7.5	—	ns
	Clock to Output Valid	t _{KQ}	—	4.0	—	4.2	—	4.5	—	5.5	—	6.5	—	7.5	ns
	Clock to Output Invalid	t _{KQX}	2.0	—	2.0	—	2.0	—	2.0	—	2.0	—	2.0	—	ns
	Clock to Output in Low-Z	t _{LZ} ¹	2.0	—	2.0	—	2.0	—	2.0	—	2.0	—	2.0	—	ns
	Setup time	t _S	1.2	—	1.2	—	1.3	—	1.5	—	1.5	—	1.5	—	ns
	Hold time	t _H	0.2	—	0.2	—	0.3	—	0.5	—	0.5	—	0.5	—	ns
	Clock HIGH Time	t _{KH}	0.9	—	0.9	—	1.0	—	1.3	—	1.3	—	1.5	—	ns
	Clock LOW Time	t _{KL}	1.1	—	1.1	—	1.2	—	1.5	—	1.5	—	1.7	—	ns
	Clock to Output in High-Z	t _{HZ} ¹	1.5	2.5	1.5	2.5	1.5	2.5	1.5	2.5	1.5	3.0	1.5	3.8	ns
	\bar{G} to Output Valid	t _{OE}	—	2.5	—	2.5	—	2.5	—	2.5	—	3.0	—	3.8	ns
	\bar{G} to output in Low-Z	t _{OLZ} ¹	0	—	0	—	0	—	0	—	0	—	0	—	ns
	\bar{G} to output in High-Z	t _{OHZ} ¹	—	2.5	—	2.5	—	2.5	—	2.5	—	3.0	—	3.8	ns
	ZZ setup time	t _{ZZS} ²	5	—	5	—	5	—	5	—	5	—	5	—	ns
	ZZ hold time	t _{ZZH} ²	1	—	1	—	1	—	1	—	1	—	1	—	ns
	ZZ recovery	t _{ZZR}	20	—	20	—	20	—	20	—	20	—	20	—	ns

Notes:

1. These parameters are sampled and are not 100% tested.
2. ZZ is an asynchronous signal. However, in order to be recognized on any given clock cycle, ZZ must meet the specified setup and hold times as specified above.

Pipeline Mode Timing (DCD)

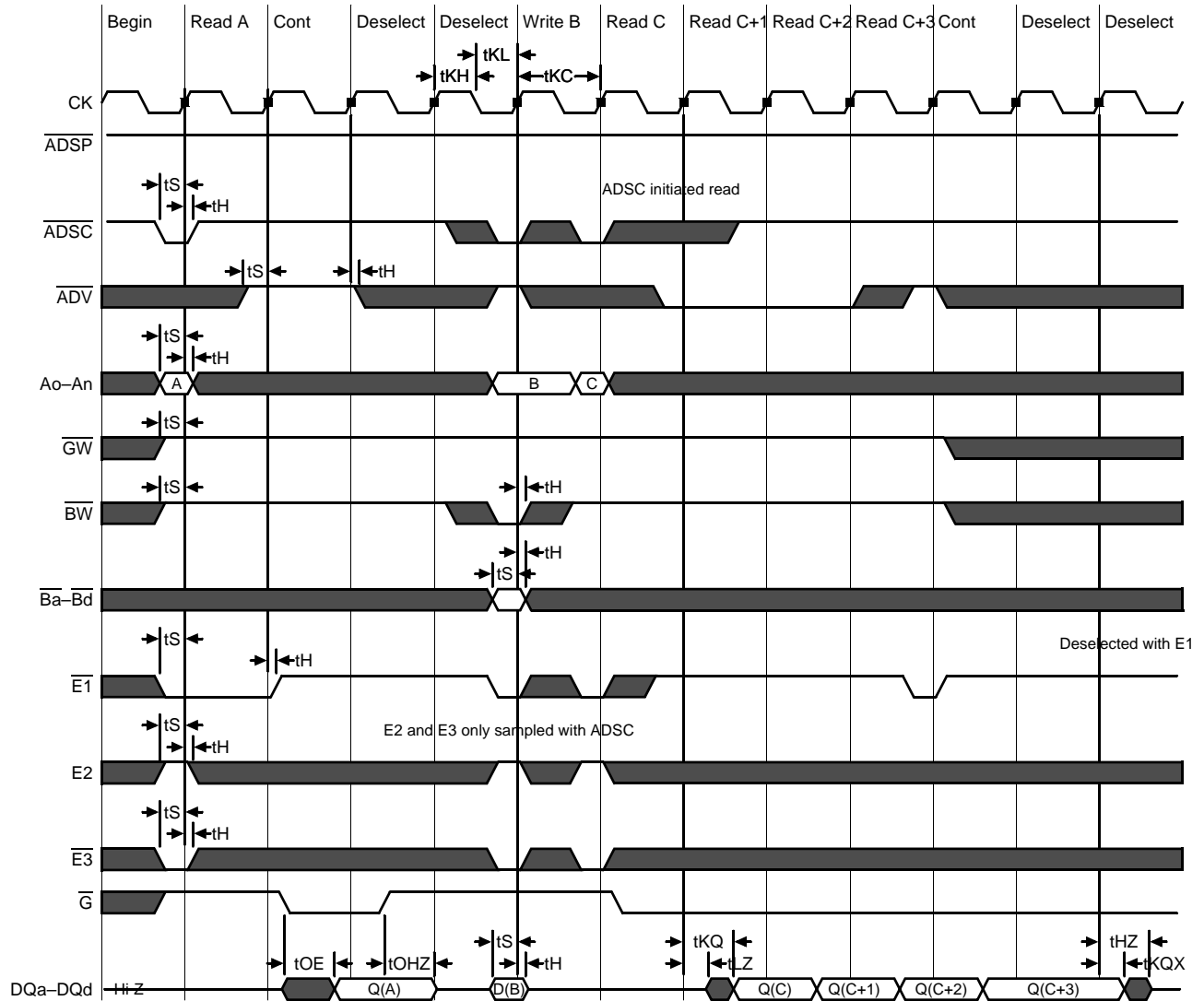

Flow Through Mode Timing (DCD)



Sleep Mode

During normal operation, ZZ must be pulled low, either by the user or by its internal pull down resistor. When ZZ is pulled high, the SRAM will enter a Power Sleep mode after 2 cycles. At this time, internal state of the SRAM is preserved. When ZZ returns to low, the SRAM operates normally after 2 cycles of wake up time.

Sleep mode is a low current, power-down mode in which the device is deselected and current is reduced to I_{SB2} . The duration of Sleep mode is dictated by the length of time the ZZ is in a High state. After entering Sleep mode, all inputs except ZZ become disabled and all outputs go to High-Z. The ZZ pin is an asynchronous, active high input that causes the device to enter Sleep mode. When the ZZ pin is driven high, I_{SB2} is guaranteed after the time t_{ZZI} is met. Because ZZ is an asynchronous input, pending operations or operations in progress may not be properly completed if ZZ is asserted. Therefore, Sleep mode must not be initiated until valid pending operations are completed. Similarly, when exiting Sleep mode during t_{ZZR} , only a Deselect or Read commands may be applied while the SRAM is recovering from Sleep mode.

Sleep Mode Timing Diagram

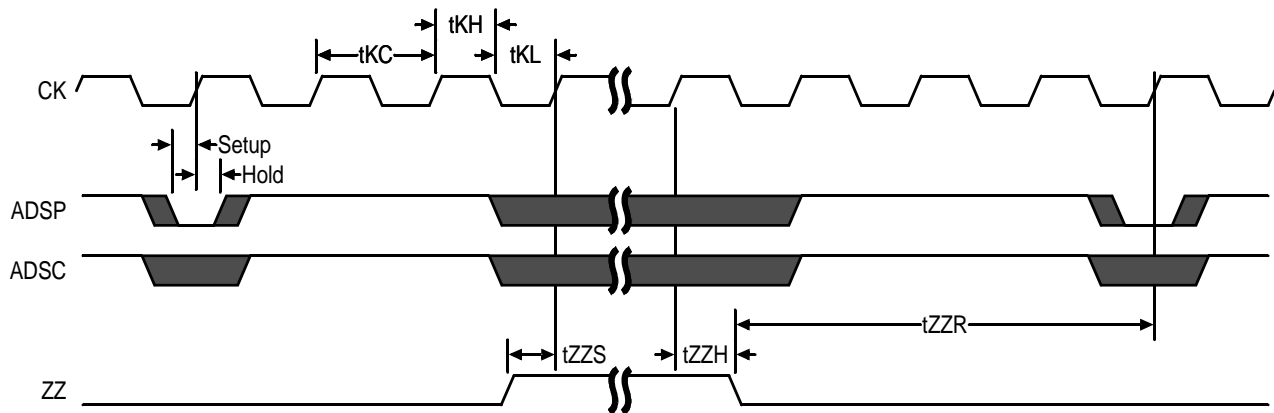

TQFP Package Drawing (Package GT)

Symbol	Description	Min.	Nom.	Max
A1	Standoff	0.05	0.10	0.15
A2	Body Thickness	1.35	1.40	1.45
b	Lead Width	0.20	0.30	0.40
c	Lead Thickness	0.09	—	0.20
D	Terminal Dimension	21.9	22.0	22.1
D1	Package Body	19.9	20.0	20.1
E	Terminal Dimension	15.9	16.0	16.1
E1	Package Body	13.9	14.0	14.1
e	Lead Pitch	—	0.65	—
L	Foot Length	0.45	0.60	0.75
L1	Lead Length	—	1.00	—
Y	Coplanarity			0.10
θ	Lead Angle	0°	—	7°

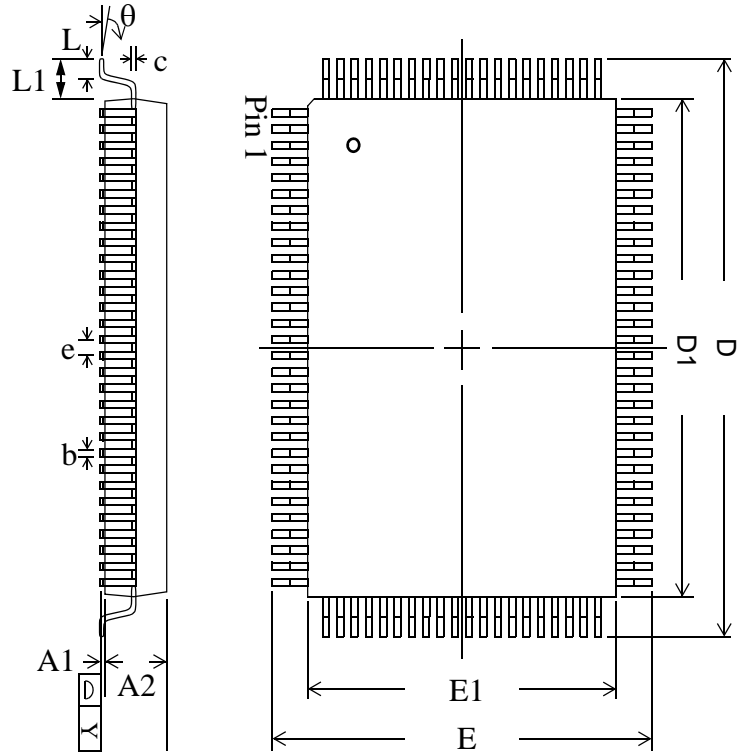

Notes:

1. All dimensions are in millimeters (mm).
2. Package width and length do not include mold protrusion.

Ordering Information for GSI Synchronous Burst RAMs

Org	Part Number ¹	Type	Package	Speed ² (MHz/ns)	T _J ³
1M x 18	GS8160E18DGT-400	Pipeline/Flow Through	RoHS-compliant TQFP	400/4.0	C
1M x 18	GS8160E18DGT-375	Pipeline/Flow Through	RoHS-compliant TQFP	375/4.2	C
1M x 18	GS8160E18DGT-333	Pipeline/Flow Through	RoHS-compliant TQFP	333/4.5	C
1M x 18	GS8160E18DGT-250	Pipeline/Flow Through	RoHS-compliant TQFP	250/5.5	C
1M x 18	GS8160E18DGT-200	Pipeline/Flow Through	RoHS-compliant TQFP	200/6.5	C
1M x 18	GS8160E18DGT-150	Pipeline/Flow Through	RoHS-compliant TQFP	150/7.5	C
512K x 32	GS8160E32DGT-400	Pipeline/Flow Through	RoHS-compliant TQFP	400/4.0	C
512K x 32	GS8160E32DGT-375	Pipeline/Flow Through	RoHS-compliant TQFP	375/4.2	C
512K x 32	GS8160E32DGT-333	Pipeline/Flow Through	RoHS-compliant TQFP	333/4.5	C
512K x 32	GS8160E32DGT-250	Pipeline/Flow Through	RoHS-compliant TQFP	250/5.5	C
512K x 32	GS8160E32DGT-200	Pipeline/Flow Through	RoHS-compliant TQFP	200/6.5	C
512K x 32	GS8160E32DGT-150	Pipeline/Flow Through	RoHS-compliant TQFP	150/7.5	C
512K x 36	GS8160E36DGT-400	Pipeline/Flow Through	RoHS-compliant TQFP	400/4.0	C
512K x 36	GS8160E36DGT-375	Pipeline/Flow Through	RoHS-compliant TQFP	375/4.2	C
512K x 36	GS8160E36DGT-333	Pipeline/Flow Through	RoHS-compliant TQFP	333/4.5	C
512K x 36	GS8160E36DGT-250	Pipeline/Flow Through	RoHS-compliant TQFP	250/5.5	C
512K x 36	GS8160E36DGT-200	Pipeline/Flow Through	RoHS-compliant TQFP	200/6.5	C
512K x 36	GS8160E36DGT-150	Pipeline/Flow Through	RoHS-compliant TQFP	150/7.5	C
1M x 18	GS8160E18DGT-400I	Pipeline/Flow Through	RoHS-compliant TQFP	400/4.0	I
1M x 18	GS8160E18DGT-375I	Pipeline/Flow Through	RoHS-compliant TQFP	375/4.2	I
1M x 18	GS8160E18DGT-333I	Pipeline/Flow Through	RoHS-compliant TQFP	333/4.5	I
1M x 18	GS8160E18DGT-250I	Pipeline/Flow Through	RoHS-compliant TQFP	250/5.5	I
1M x 18	GS8160E18DGT-200I	Pipeline/Flow Through	RoHS-compliant TQFP	200/6.5	I
1M x 18	GS8160E18DGT-150I	Pipeline/Flow Through	RoHS-compliant TQFP	150/7.5	I
512K x 32	GS8160E32DGT-400I	Pipeline/Flow Through	RoHS-compliant TQFP	400/4.0	I
512K x 32	GS8160E32DGT-375I	Pipeline/Flow Through	RoHS-compliant TQFP	375/4.2	I
512K x 32	GS8160E32DGT-333I	Pipeline/Flow Through	RoHS-compliant TQFP	333/4.5	I
512K x 32	GS8160E32DGT-250I	Pipeline/Flow Through	RoHS-compliant TQFP	250/5.5	I

Notes:

- Customers requiring delivery in Tape and Reel should add the character "T" to the end of the part number.
Example: GS8160E18DGT-150IT.
- The speed column indicates the cycle frequency (MHz) of the device in Pipeline mode and the latency (ns) in Flow Through mode. Each device is Pipeline/Flow Through mode-selectable by the user.
- C = Commercial Temperature Range. I = Industrial Temperature Range.
- GSI offers other versions this type of device in many different configurations and with a variety of different features, only some of which are covered in this data sheet. See the GSI Technology web site (www.gsistechnology.com) for a complete listing of current offerings.

Ordering Information for GSI Synchronous Burst RAMs

Org	Part Number ¹	Type	Package	Speed ² (MHz/ns)	T _J ³
512K x 32	GS8160E32DGT-200I	Pipeline/Flow Through	RoHS-compliant TQFP	200/6.5	I
512K x 32	GS8160E32DGT-150I	Pipeline/Flow Through	RoHS-compliant TQFP	150/7.5	I
512K x 36	GS8160E36DGT-400I	Pipeline/Flow Through	RoHS-compliant TQFP	400/4.0	I
512K x 36	GS8160E36DGT-375I	Pipeline/Flow Through	RoHS-compliant TQFP	375/4.2	I
512K x 36	GS8160E36DGT-333I	Pipeline/Flow Through	RoHS-compliant TQFP	333/4.5	I
512K x 36	GS8160E36DGT-250I	Pipeline/Flow Through	RoHS-compliant TQFP	250/5.5	I
512K x 36	GS8160E36DGT-200	Pipeline/Flow Through	RoHS-compliant TQFP	200/6.5	I
512K x 36	GS8160E36DGT-150I	Pipeline/Flow Through	RoHS-compliant TQFP	150/7.5	I

Notes:

- Customers requiring delivery in Tape and Reel should add the character "T" to the end of the part number.
Example: GS8160E18DGT-150IT.
- The speed column indicates the cycle frequency (MHz) of the device in Pipeline mode and the latency (ns) in Flow Through mode. Each device is Pipeline/Flow Through mode-selectable by the user.
- C = Commercial Temperature Range. I = Industrial Temperature Range.
- GSI offers other versions this type of device in many different configurations and with a variety of different features, only some of which are covered in this data sheet. See the GSI Technology web site (www.gsitechnology.com) for a complete listing of current offerings.

18Mb Sync SRAM Datasheet Revision History

File Name	Types of Changes Format or Content	Description of changes
8160ExxD_r1		• Creation of new datasheet
8160ExxD_r1_01	Content	• Addition of IDD numbers
8160ExxD_r1_02	Content	• Updated Absolute Maximum Ratings
8160ExxD_r1_03	Content	• Updated to reflect MP status • (Rev1.03a: Corrected thermal impedance numbers)



Компания «ЭлектроПласт» предлагает заключение долгосрочных отношений при поставках импортных электронных компонентов на взаимовыгодных условиях!

Наши преимущества:

- Оперативные поставки широкого спектра электронных компонентов отечественного и импортного производства напрямую от производителей и с крупнейших мировых складов;
- Поставка более 17-ти миллионов наименований электронных компонентов;
- Поставка сложных, дефицитных, либо снятых с производства позиций;
- Оперативные сроки поставки под заказ (от 5 рабочих дней);
- Экспресс доставка в любую точку России;
- Техническая поддержка проекта, помощь в подборе аналогов, поставка прототипов;
- Система менеджмента качества сертифицирована по Международному стандарту ISO 9001;
- Лицензия ФСБ на осуществление работ с использованием сведений, составляющих государственную тайну;
- Поставка специализированных компонентов (Xilinx, Altera, Analog Devices, Intersil, Interpoint, Microsemi, Aeroflex, Peregrine, Syfer, Eurofarad, Texas Instrument, Miteq, Cobham, E2V, MA-COM, Hittite, Mini-Circuits, General Dynamics и др.);

Помимо этого, одним из направлений компании «ЭлектроПласт» является направление «Источники питания». Мы предлагаем Вам помощь Конструкторского отдела:

- Подбор оптимального решения, техническое обоснование при выборе компонента;
- Подбор аналогов;
- Консультации по применению компонента;
- Поставка образцов и прототипов;
- Техническая поддержка проекта;
- Защита от снятия компонента с производства.



Как с нами связаться

Телефон: 8 (812) 309 58 32 (многоканальный)

Факс: 8 (812) 320-02-42

Электронная почта: org@eplast1.ru

Адрес: 198099, г. Санкт-Петербург, ул. Калинина, дом 2, корпус 4, литера А.