

General Specifications

Electrical Capacity (Resistive Load)

Logic Level: 0.4VA maximum @ 48V AC/DC maximum
(Applicable Range 0.1mA ~ 0.1A @ 20mV ~ 48V)
Note: Find additional explanation of operating range in Supplement section.

Other Ratings

Contact Resistance: 50 milliohms maximum
Insulation Resistance: 1,000 megohms minimum @ 500V DC
Dielectric Strength: 1,000V AC minimum between contacts for 1 minute minimum;
1,500V AC minimum between contacts & case for 1 minute minimum
Mechanical Life: 100,000 operations minimum for bat lever models
50,000 operations minimum for locking lever models
Electrical Life: 50,000 operations minimum
Contact Timing: Nonshorting (break-before-make)
Angle of Throw: 24°

Materials & Finishes

Toggle/Lever: Brass with chrome plating
Bushing: Brass with nickel plating
Support Bracket: Straight PC: phosphor bronze with tin plating; right angle & vertical: brass with tin plating
Housing: Polybutylene terephthalate (PBT) (UL94V-0)
Base: 1- and 2-pole GFR polyamide (UL94V-0); 4-pole liquid crystal polymer (LCP) (UL94V-0)
Movable Contacts: Phosphor bronze with gold plating
Stationary Contacts: Brass with gold plating
Terminals: Brass with gold plating

Environmental Data

Operating Temp Range: -10°C through +70°C (+14°F through +158°F)
Humidity: 90 ~ 95% humidity for 240 hours @ 40°C (104°F)
Vibration: 10 ~ 55Hz with peak-to-peak amplitude of 1.5mm traversing the frequency range & returning in 1 minute; 3 right angled directions for 2 hours
Shock: 50G (490m/s²) acceleration (tested in 6 right angled directions, with 5 shocks in each direction)

PCB Processing

Soldering: Wave Soldering recommended. See Profile A in Supplement section.
Manual Soldering: 1- & 2-pole: 3 seconds maximum @ 350°C maximum;
4-pole: 4 seconds maximum @ 410°C maximum
Cleaning: Hand clean locally using alcohol based solution.
See Cleaning specifications in Supplement section.

Standards & Certifications

Flammability Standards: UL94V-0 rated housing & base
The D2 Series toggles have not been tested for UL recognition or CSA certification.
These switches are designed for use in a low-current, logic level circuit.
When used as intended in a logic level circuit, the results do not produce hazardous energy.

Distinctive Characteristics

Base of heat resistant resin meets UL94V-0 flammability rating.

Maximized voltage capability of 48V allows use in medium source applications and increases operating life.

Award-winning STC contact mechanism with benefits unavailable in conventional mechanisms: smoother positive detent actuation, increased contact stability, and unparalleled reliability. (Additional STC details under Terms and Acronyms in the Supplement section.)

Round .031" (0.8mm) diameter PC terminals for easy PCB assembly.

Terminal spacing conforms to standard .100" (2.54mm) PC board grid spacing.

Molded-in terminals prevent entry of flux, solvents, and other contaminants.

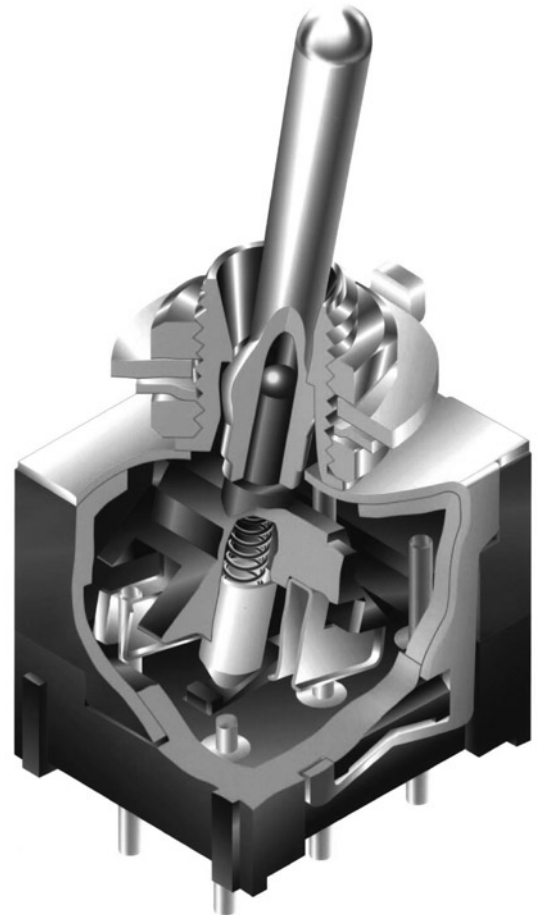

Actual Size

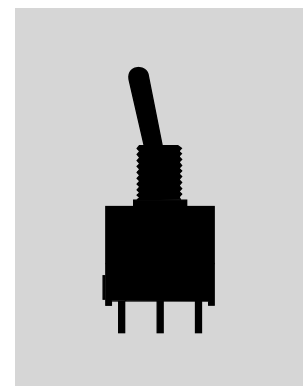
A
Toggles

Rockers

Pushbuttons

Illuminated PB

Programmable

Keylocks

Rotaries

Slides

Tactiles

Tilt

Touch

Indicators

Accessories

Supplement

TYPICAL SWITCH ORDERING EXAMPLE

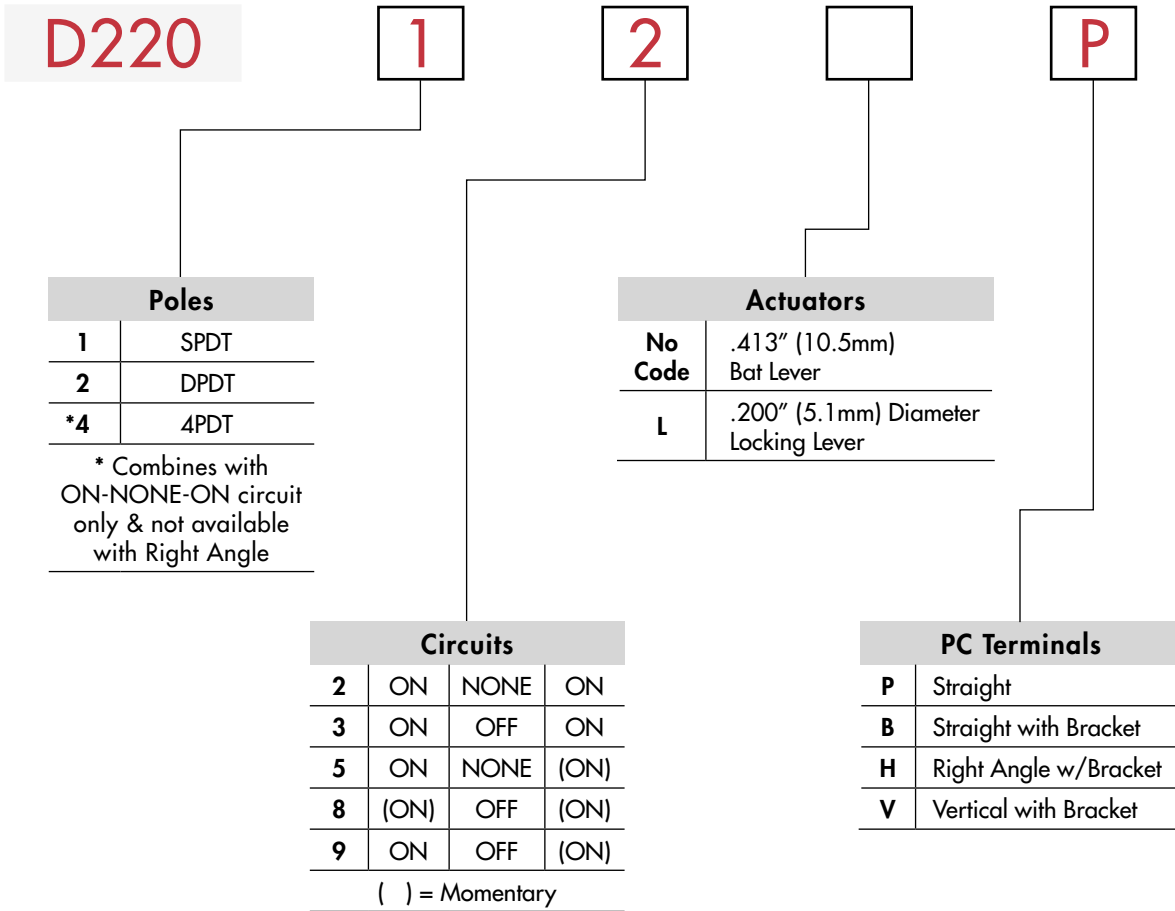

DESCRIPTION FOR TYPICAL ORDERING EXAMPLE

D22012P



POLES & CIRCUITS

Pole	Model	Toggle Position () = Momentary			Connected Terminals			Throw & Schematics
		Down <small>Keyway</small>	Center	Up	Down <small>Keyway</small>	Center	Up	
SP	D22012 D22013 D22015 D22018 D22019	ON ON ON (ON) ON	NONE OFF NONE OFF OFF	ON ON (ON) (ON) (ON)	2-3	OPEN	2-1	Note: Terminal numbers are not actually on the switch. SPDT
DP	D22022 D22023 D22025 D22028 D22029	ON ON ON (ON) ON	NONE OFF NONE OFF OFF	ON ON (ON) (ON) (ON)	2-3 5-6	OPEN	2-1 5-4	DPDT
4P	D22042	ON	NONE	ON	2-3 5-6 8-9 11-12	OPEN	2-1 5-4 8-7 11-10	4PDT

ACTUATORS

No Code

**.413" (10.5mm)
Bat Lever**

Material:
Chrome over brass

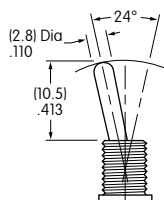

L

**.413" (5.1mm) Diameter
Locking Lever**

Material:
Chrome over brass

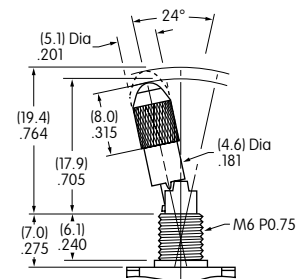

PC TERMINALS

P

Straight



B

Straight with Bracket



H

Right Angle with Bracket

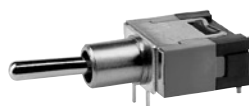

V

Vertical with Bracket

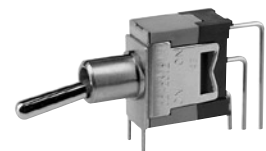

OPTIONAL CAPS & CAP COLORS

**AT415
Bat Lever Cap**

Material:
Polyethylene

Colors Available:
A B C E F G

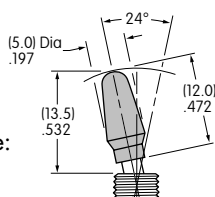

**AT444 Bat Lever
Conical Cap**

Material:
Polyethylene

Colors Available:
A B C E F G

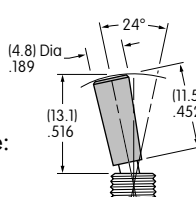

**AT427 Cap Supplied
with Locking Lever**

Material:
Anodized
Aluminum

Colors Available:
A C G

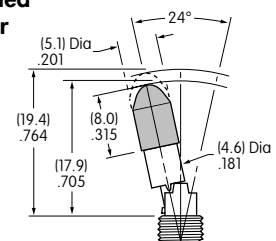

Colors Codes: A Black B White C Red E Yellow F Green G Blue

TYPICAL SWITCH DIMENSIONS

Straight PC • Single Pole



D22012P

D22012LP

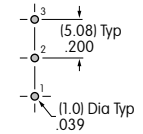
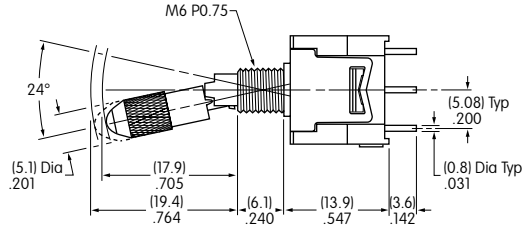
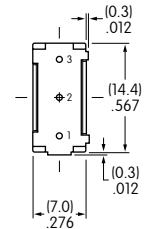
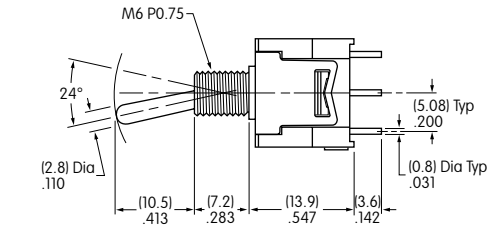
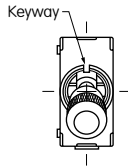
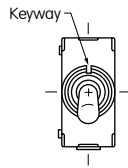

Actuator in Down Position

Straight PC • Double Pole



D22022P

D22022LP

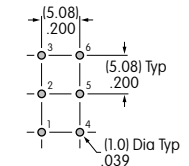
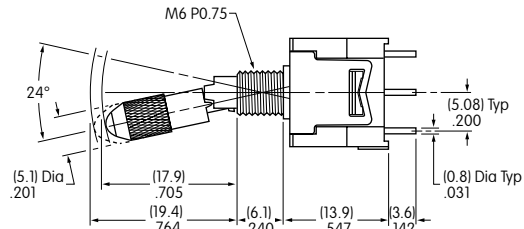
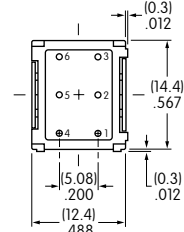
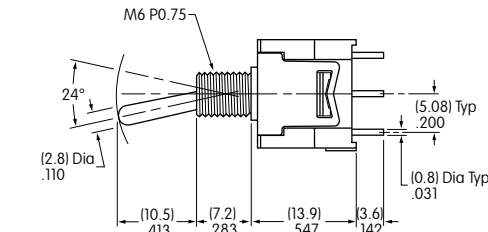
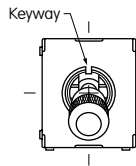
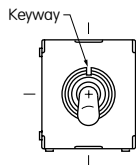

Actuator in Down Position

Straight PC • Four Pole

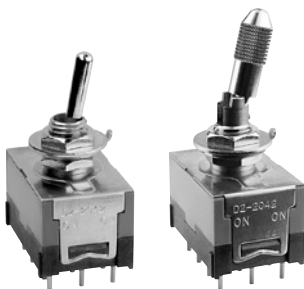

D22042P

D22042LP

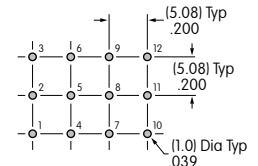
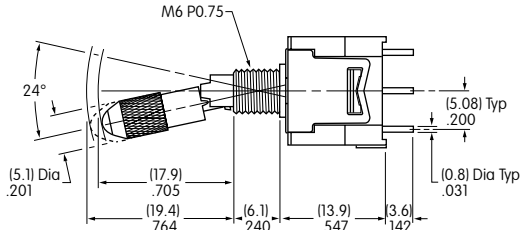
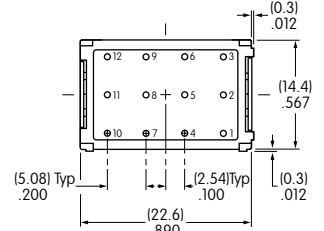
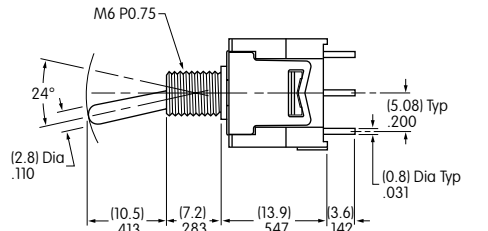
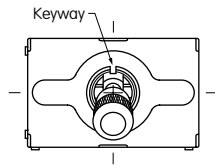
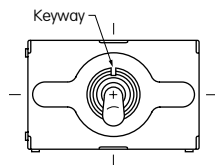

Actuator in Down Position

Rockers

Pushbuttons

Programmable Illuminated PB

Keylocks

Rotaries

Slides

Tactiles

Tilt

Touch

Indicators

Accessories

Supplement

TYPICAL SWITCH DIMENSIONS

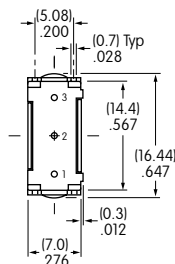
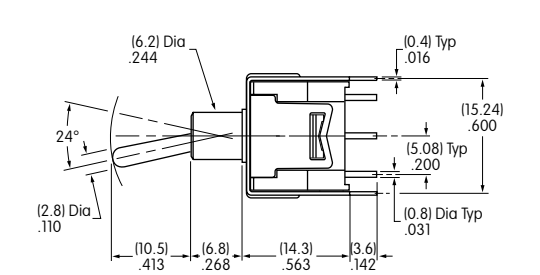
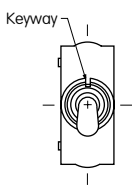

Straight PC • Bracket Single Pole

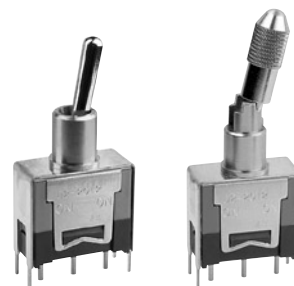

D22012B

D22012LB

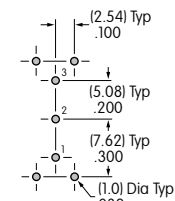
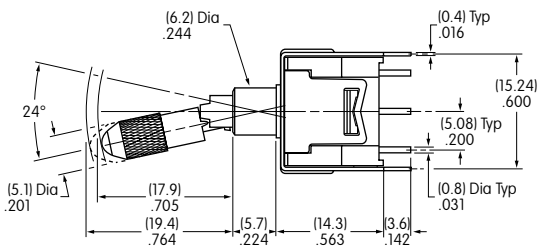
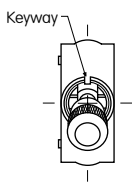

Actuator in Down Position

Straight PC • Bracket Double Pole

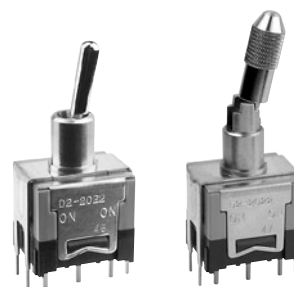
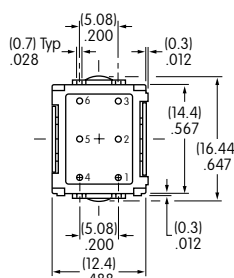
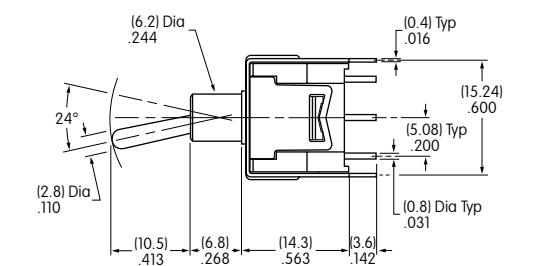
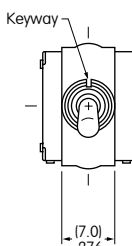

D22022B

D22022LB

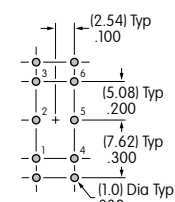
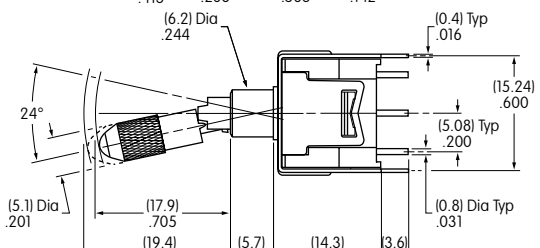
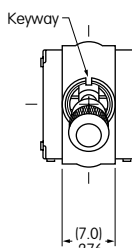

Actuator in Down Position

Straight PC • Bracket Four Pole

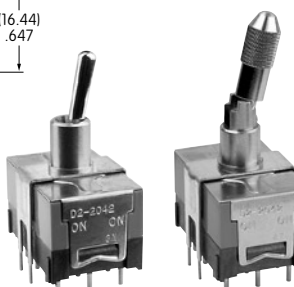
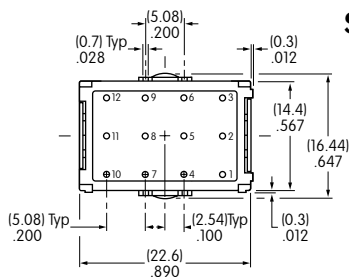
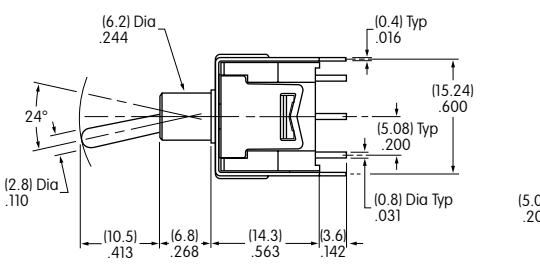
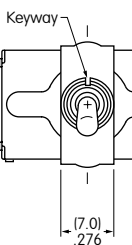

D22042B

D22042LB

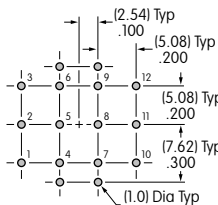
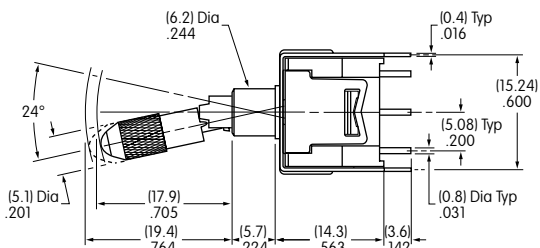
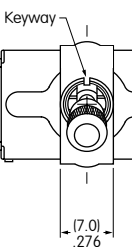

Actuator in Down Position

A Toggles

Rockers

Pushbuttons

Illuminated PB

Programmable

Keylocks

Rotaries

Slides

Tactiles

Tilt

Touch

Indicators

Accessories

Supplement

TYPICAL SWITCH DIMENSIONS

Right Angle PC • Single Pole



D22012H

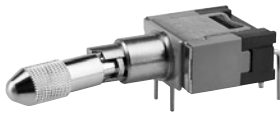
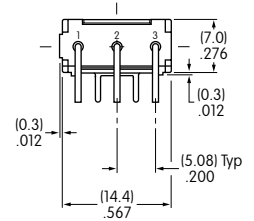
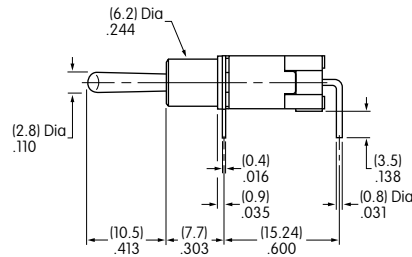
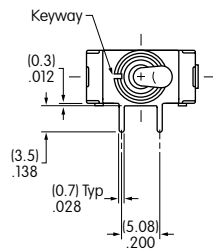

D22012LH

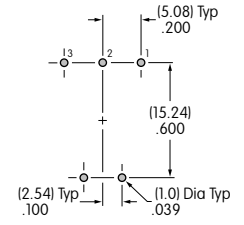
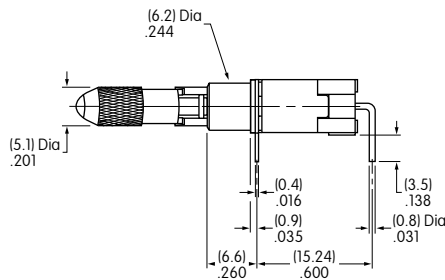
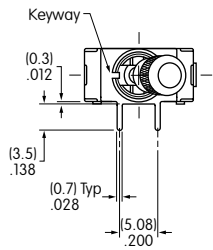

Actuator in Down Position

Right Angle PC • Double Pole



D22022H

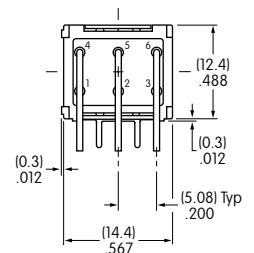
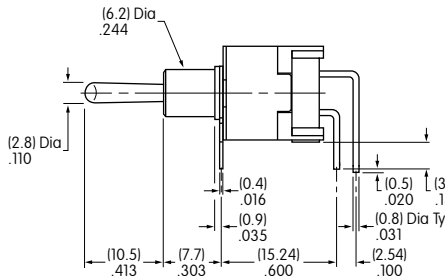
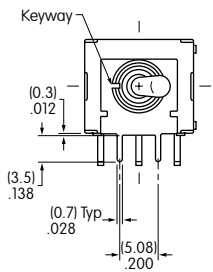

D22022LH

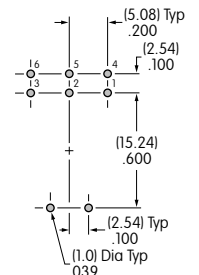
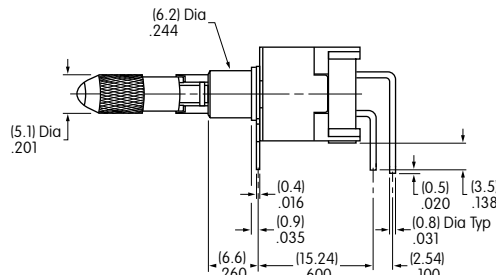
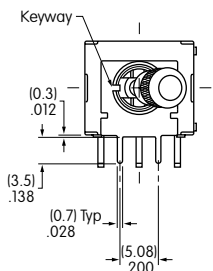

Actuator in Down Position

Rockers

Pushbuttons

Illuminated PB

Programmable

Keylocks

Rotaries

Slides

Tactiles

Tilt

Touch

Indicators

Accessories

Supplement

TYPICAL SWITCH DIMENSIONS

Vertical PC • Single Pole

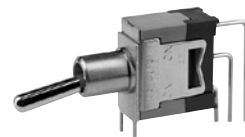
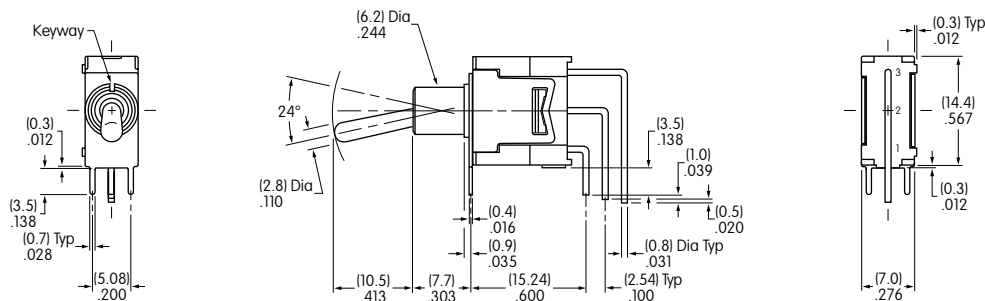

D22012V

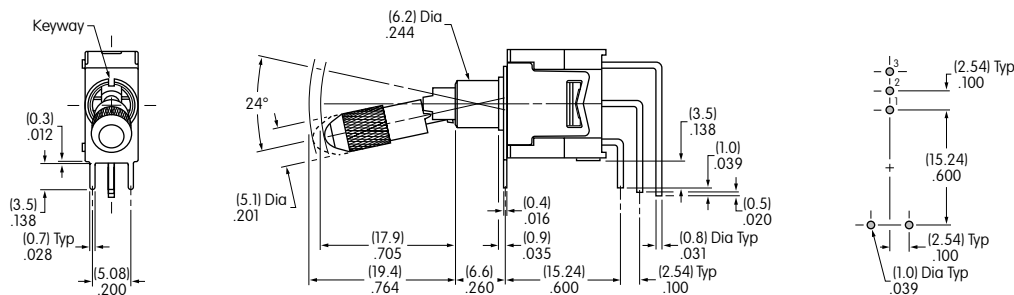

Actuator in Down Position

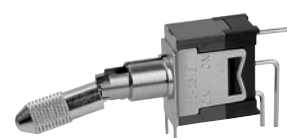

D22012LV

Vertical PC • Double Pole

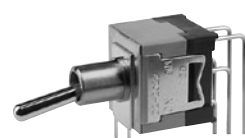
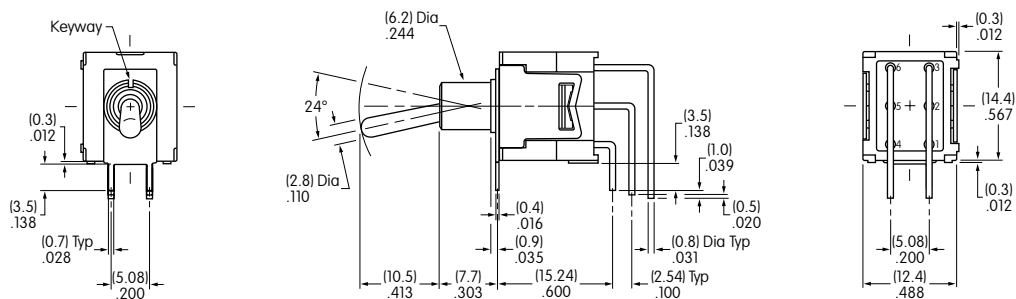

D22022V

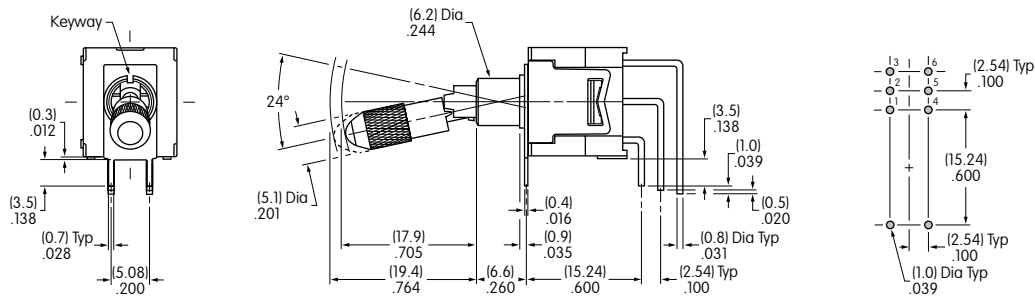

Actuator in Down Position

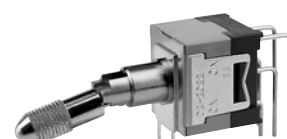

D22022LV

A	Toggles
	Rockers
	Pushbuttons
	Illuminated PB
	Programmable
	Keylocks
	Rotaries
	Slides
	Tactiles
	Tilt
	Touch
	Indicators
	Accessories
	Supplement

TYPICAL SWITCH DIMENSIONS

Vertical PC • Four Pole

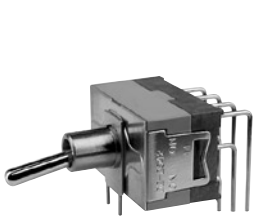

D22042V

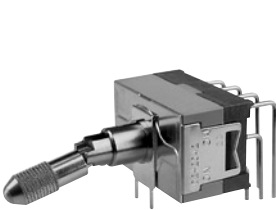
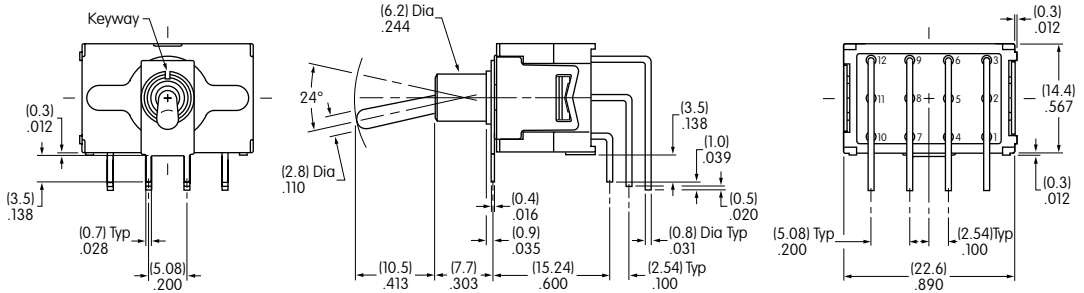

D22042LV

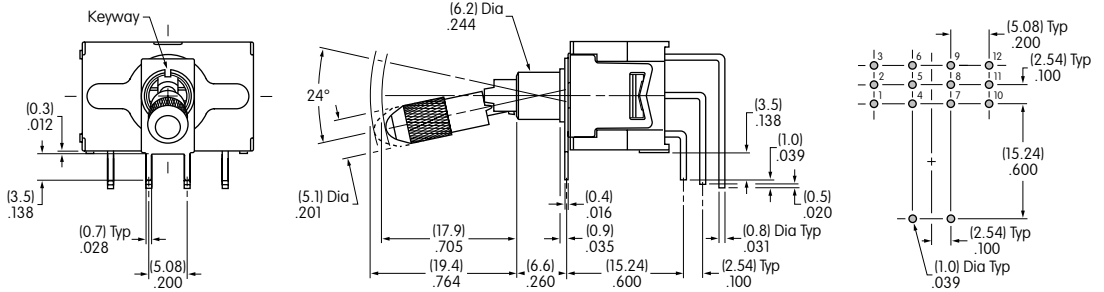

Actuator in Down Position

STANDARD HARDWARE

OPTIONAL

AT513M
Hex Nut
 Brass with nickel plating
 2 supplied

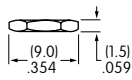
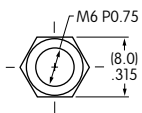

AT507M
Locking Ring
 Steel with zinc/chromate
 1 supplied

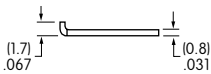
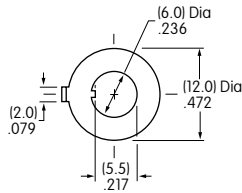

AT509
Lockwasher
 Steel with zinc/chromate
 1 supplied

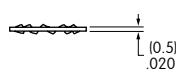
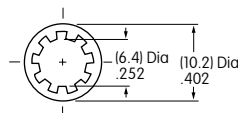

AT501M
Knurled Face Nut
 Brass with chrome plating

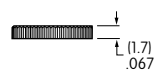
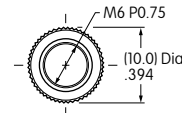

PANEL CUTOUTS & MAXIMUM PANEL THICKNESS

With Standard Hardware

.087" (2.2mm) for Standard Lever

.051" (1.3mm) for Locking Lever

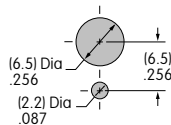

Without Bottom Hex Nut

.154" (3.9mm) for Standard Lever

.110" (2.8mm) for Locking Lever

Without Locking Ring

.118" (3.0mm) for Standard Lever

.083" (2.1mm) for Locking Lever

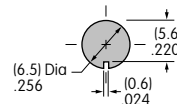

Without Locking Ring & Bottom Hex Nut

.185" (4.7mm) for Standard Lever

.142" (3.6mm) for Locking Lever

Mouser Electronics

Authorized Distributor

Click to View Pricing, Inventory, Delivery & Lifecycle Information:

NKK Switches:

[D22012B](#) [D22029B](#) [D22029H](#) [D22029LB](#) [D22029LH](#) [D22029LP](#) [D22029LV](#) [D22029V](#) [D22042B](#) [D22042LB](#)
[D22042LP](#) [D22042LV](#) [D22042P](#) [D22042V](#) [D22012LP](#) [D22013B](#)



Компания «ЭлектроПласт» предлагает заключение долгосрочных отношений при поставках импортных электронных компонентов на взаимовыгодных условиях!

Наши преимущества:

- Оперативные поставки широкого спектра электронных компонентов отечественного и импортного производства напрямую от производителей и с крупнейших мировых складов;
- Поставка более 17-ти миллионов наименований электронных компонентов;
- Поставка сложных, дефицитных, либо снятых с производства позиций;
- Оперативные сроки поставки под заказ (от 5 рабочих дней);
- Экспресс доставка в любую точку России;
- Техническая поддержка проекта, помощь в подборе аналогов, поставка прототипов;
- Система менеджмента качества сертифицирована по Международному стандарту ISO 9001;
- Лицензия ФСБ на осуществление работ с использованием сведений, составляющих государственную тайну;
- Поставка специализированных компонентов (Xilinx, Altera, Analog Devices, Intersil, Interpoint, Microsemi, Aeroflex, Peregrine, Syfer, Eurofarad, Texas Instrument, Miteq, Cobham, E2V, MA-COM, Hittite, Mini-Circuits, General Dynamics и др.);

Помимо этого, одним из направлений компании «ЭлектроПласт» является направление «Источники питания». Мы предлагаем Вам помощь Конструкторского отдела:

- Подбор оптимального решения, техническое обоснование при выборе компонента;
- Подбор аналогов;
- Консультации по применению компонента;
- Поставка образцов и прототипов;
- Техническая поддержка проекта;
- Защита от снятия компонента с производства.



Как с нами связаться

Телефон: 8 (812) 309 58 32 (многоканальный)

Факс: 8 (812) 320-02-42

Электронная почта: org@eplast1.ru

Адрес: 198099, г. Санкт-Петербург, ул. Калинина, дом 2, корпус 4, литера А.