

# General Specifications

## Electrical Capacity (Resistive Load)

**Logic Level:** 0.4VA maximum @ 48V AC/DC maximum  
(Applicable Range 0.1mA ~ 0.1A @ 20mV ~ 48V)  
Note: Find additional explanation of operating range in Supplement section.

## Other Ratings

**Contact Resistance:** 50 milliohms maximum  
**Insulation Resistance:** 1,000 megohms minimum @ 500V DC  
**Dielectric Strength:** 1,000V AC minimum between contacts for 1 minute minimum;  
1,500V AC minimum between contacts & case for 1 minute minimum  
**Mechanical Life:** 100,000 operations minimum for bat lever models  
50,000 operations minimum for locking lever models  
**Electrical Life:** 50,000 operations minimum  
**Contact Timing:** Nonshorting (break-before-make)  
**Angle of Throw:** 24°

## Materials & Finishes

**Toggle/Lever:** Brass with chrome plating  
**Bushing:** Brass with nickel plating  
**Support Bracket:** Straight PC: phosphor bronze with tin plating; right angle & vertical: brass with tin plating  
**Housing:** Polybutylene terephthalate (PBT) (UL94V-0)  
**Base:** 1- and 2-pole GFR polyamide (UL94V-0); 4-pole liquid crystal polymer (LCP) (UL94V-0)  
**Movable Contacts:** Phosphor bronze with gold plating  
**Stationary Contacts:** Brass with gold plating  
**Terminals:** Brass with gold plating

## Environmental Data

**Operating Temp Range:** -10°C through +70°C (+14°F through +158°F)  
**Humidity:** 90 ~ 95% humidity for 240 hours @ 40°C (104°F)  
**Vibration:** 10 ~ 55Hz with peak-to-peak amplitude of 1.5mm traversing the frequency range & returning in 1 minute; 3 right angled directions for 2 hours  
**Shock:** 50G (490m/s<sup>2</sup>) acceleration (tested in 6 right angled directions, with 5 shocks in each direction)

## PCB Processing

**Soldering:** Wave Soldering recommended. See Profile A in Supplement section.  
Manual Soldering: 1- & 2-pole: 3 seconds maximum @ 350°C maximum;  
4-pole: 4 seconds maximum @ 410°C maximum  
**Cleaning:** Hand clean locally using alcohol based solution.  
See Cleaning specifications in Supplement section.

## Standards & Certifications

**Flammability Standards:** UL94V-0 rated housing & base  
The D2 Series toggles have not been tested for UL recognition or CSA certification.  
These switches are designed for use in a low-current, logic level circuit.  
When used as intended in a logic level circuit, the results do not produce hazardous energy.

# Distinctive Characteristics

Base of heat resistant resin meets UL94V-0 flammability rating.

Maximized voltage capability of 48V allows use in medium source applications and increases operating life.

Award-winning STC contact mechanism with benefits unavailable in conventional mechanisms: smoother positive detent actuation, increased contact stability, and unparalleled reliability. (Additional STC details under Terms and Acronyms in the Supplement section.)

Round .031" (0.8mm) diameter PC terminals for easy PCB assembly.

Terminal spacing conforms to standard .100" (2.54mm) PC board grid spacing.

Molded-in terminals prevent entry of flux, solvents, and other contaminants.

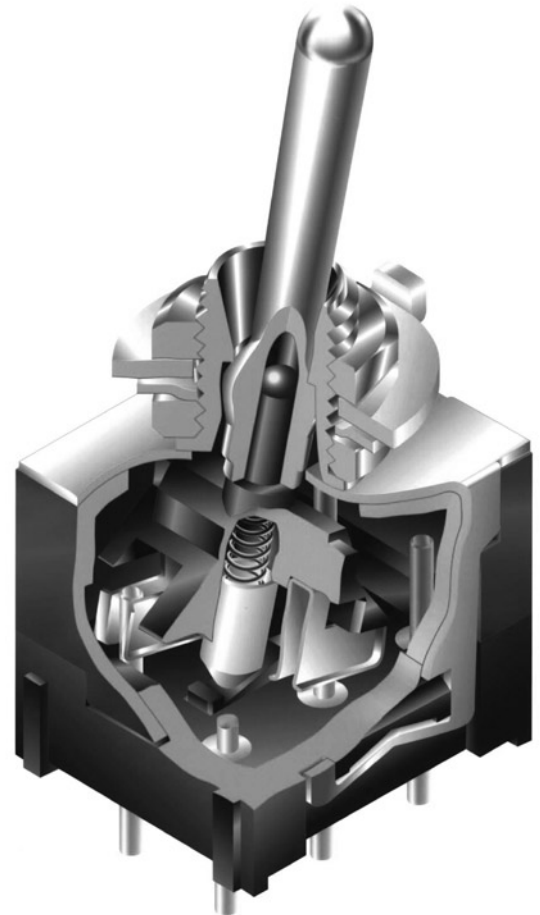

Actual Size

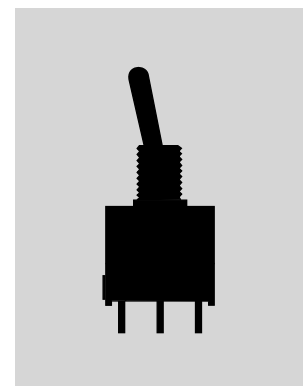

- A Toggles
- Rockers
- Pushbuttons
- Illuminated PB
- Programmable
- Keylocks
- Rotaries
- Slides
- Tactiles
- Tilt
- Touch
- Indicators
- Accessories
- Supplement

## TYPICAL SWITCH ORDERING EXAMPLE

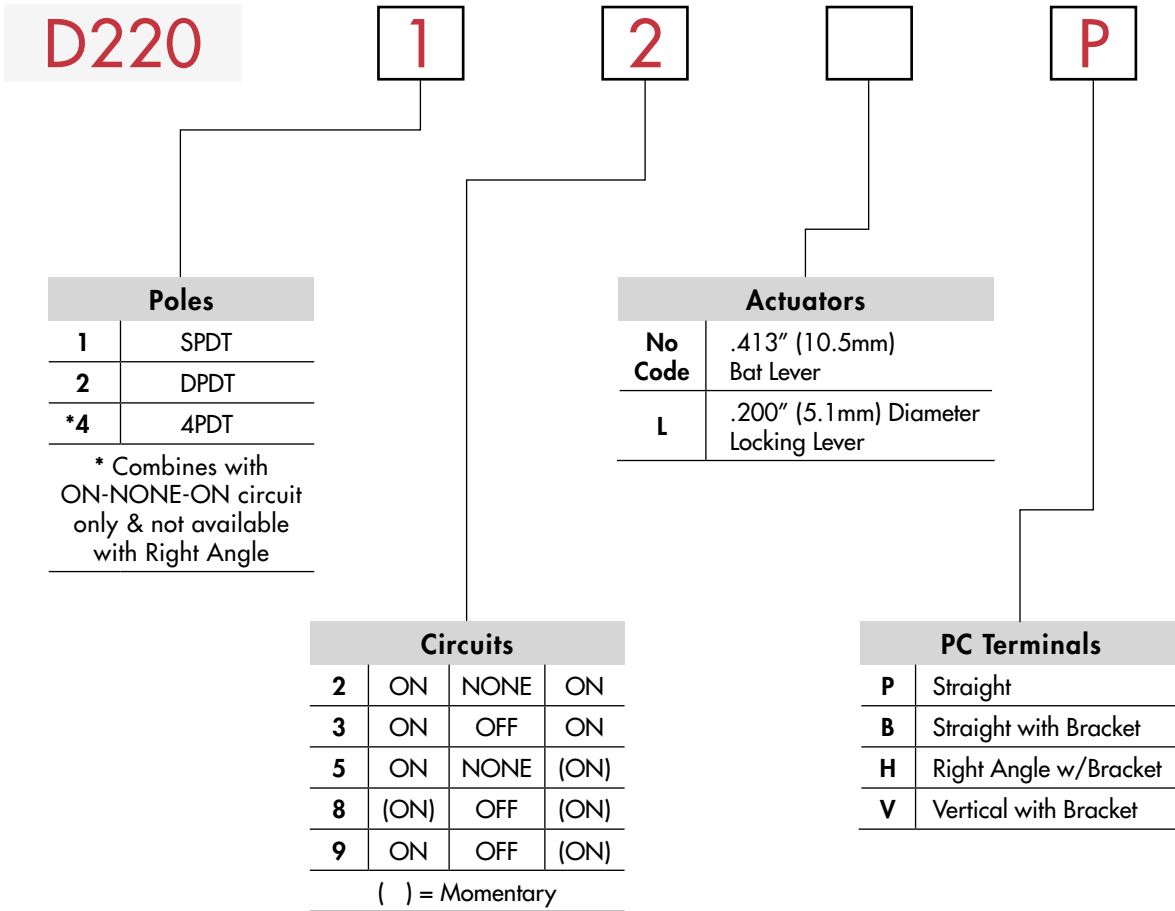

### DESCRIPTION FOR TYPICAL ORDERING EXAMPLE

#### D22012P



## POLES & CIRCUITS

Pole	Model	Toggle Position ( ) = Momentary			Connected Terminals			Throw & Schematics
		Down <small>Keyway</small>	Center	Up	Down <small>Keyway</small>	Center	Up	
SP	D22012 D22013 D22015 D22018 D22019	ON ON ON (ON) ON	NONE OFF NONE OFF OFF	ON ON (ON) (ON) (ON)	2-3	OPEN	2-1	Note: Terminal numbers are not actually on the switch. SPDT
DP	D22022 D22023 D22025 D22028 D22029	ON ON ON (ON) ON	NONE OFF NONE OFF OFF	ON ON (ON) (ON) (ON)	2-3 5-6	OPEN	2-1 5-4	DPDT
4P	D22042	ON	NONE	ON	2-3 5-6 8-9 11-12	OPEN	2-1 5-4 8-7 11-10	4PDT

## ACTUATORS

**No Code**

**.413" (10.5mm)  
Bat Lever**

Material:  
Chrome over brass

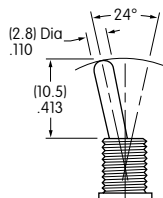

**L**

**.413" (5.1mm) Diameter  
Locking Lever**

Material:  
Chrome over brass

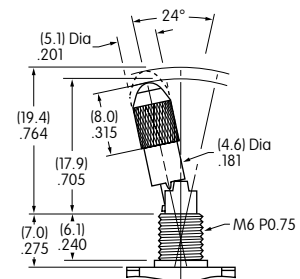

## PC TERMINALS

**P**

**Straight**



**B**

**Straight with  
Bracket**



**H**

**Right Angle  
with Bracket**

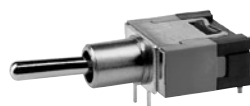

**V**

**Vertical  
with Bracket**

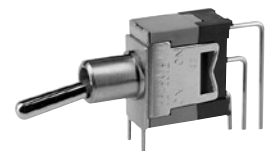

## OPTIONAL CAPS & CAP COLORS

**AT415  
Bat Lever Cap**

Material:  
Polyethylene

Colors Available:  
A B C E F G

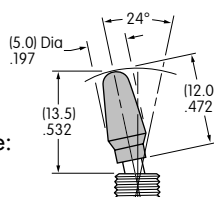

**AT444 Bat Lever  
Conical Cap**

Material:  
Polyethylene

Colors Available:  
A B C E F G

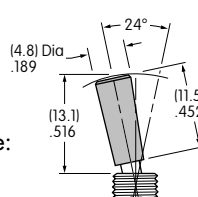

**AT427 Cap Supplied  
with Locking Lever**

Material:  
Anodized  
Aluminum

Colors Available:  
A C G

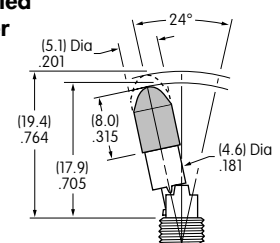

Colors Codes: A Black B White C Red E Yellow F Green G Blue

A Toggles  
 Rockers  
 Pushbuttons  
 Illuminated PB  
 Programmable  
 Keylocks  
 Rotaries  
 Slides  
 Tactiles  
 Tilt  
 Touch  
 Indicators  
 Accessories  
 Supplement

## TYPICAL SWITCH DIMENSIONS

### Straight PC • Single Pole



**D22012P**

**D22012LP**

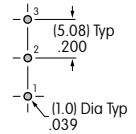
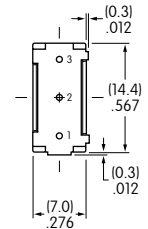
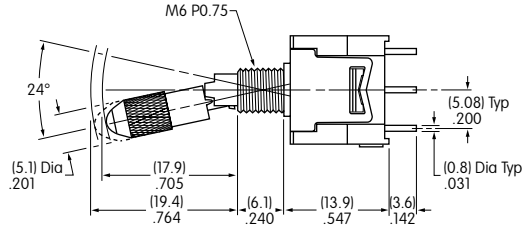
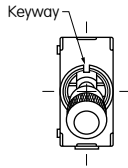
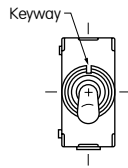

Actuator in Down Position

### Straight PC • Double Pole



**D22022P**

**D22022LP**

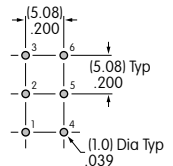
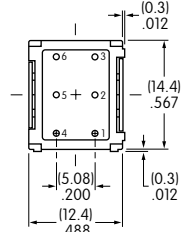
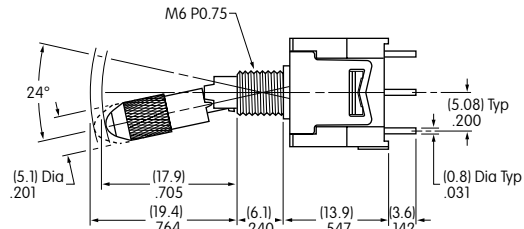
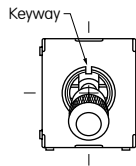
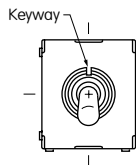

Actuator in Down Position

### Straight PC • Four Pole

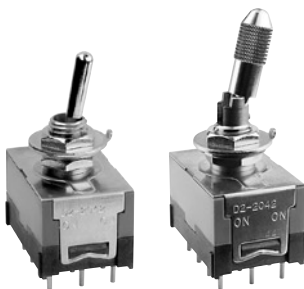

**D22042P**

**D22042LP**

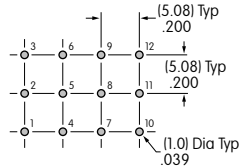
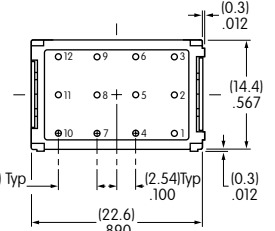
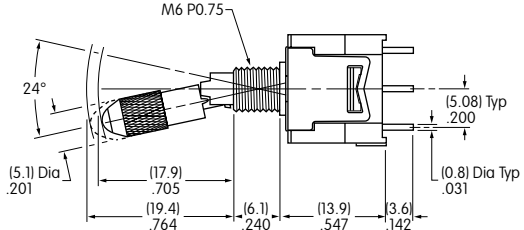
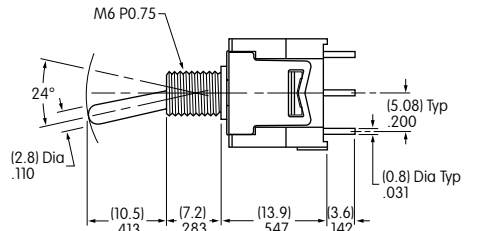
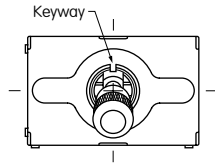
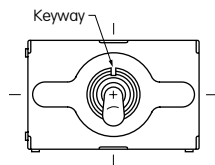

Actuator in Down Position

TYPICAL SWITCH DIMENSIONS

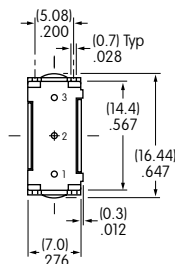

Straight PC • Bracket  
Single Pole

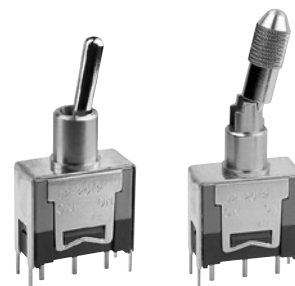

D22012B

D22012LB

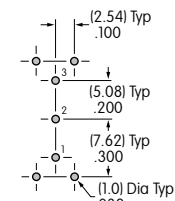

Actuator in Down Position

Straight PC • Bracket  
Double Pole

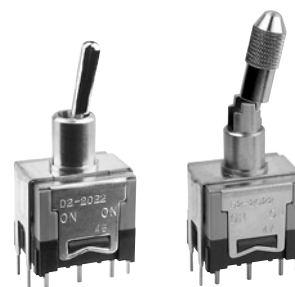
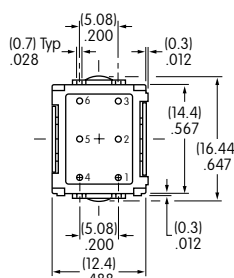
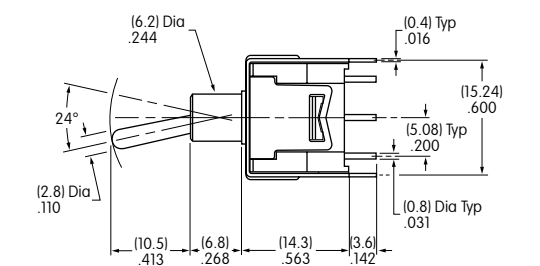

D22022B

D22022LB

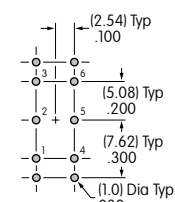
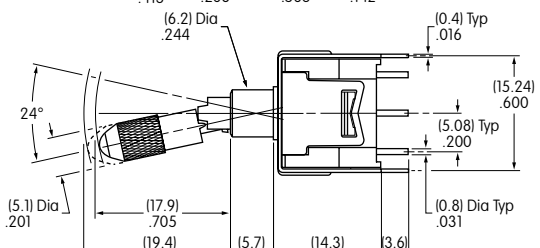
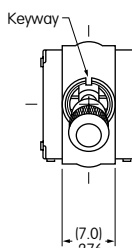

Actuator in Down Position

Straight PC • Bracket  
Four Pole

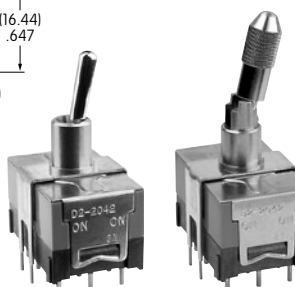
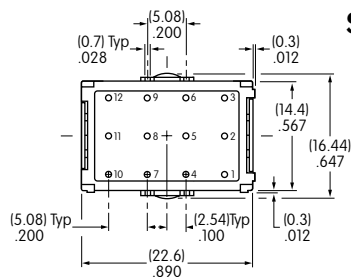
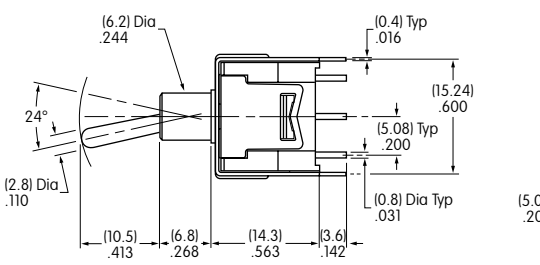
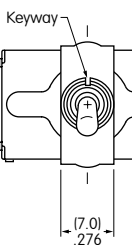

D22042B

D22042LB

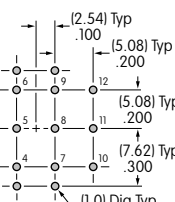
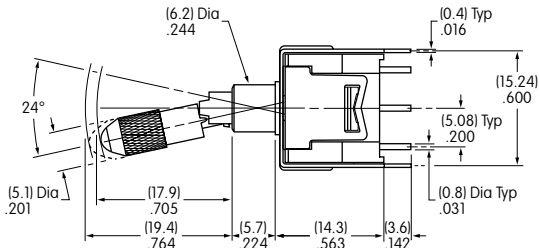

Actuator in Down Position

## TYPICAL SWITCH DIMENSIONS

### Right Angle PC • Single Pole



**D22012H**

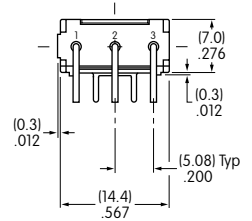
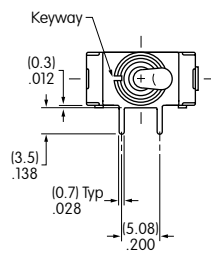

**D22012LH**

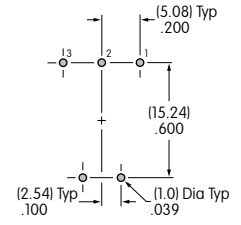
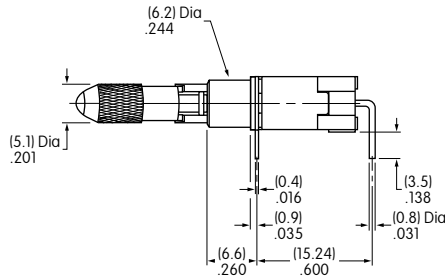
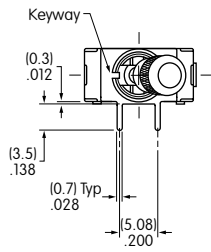

Actuator in Down Position

### Right Angle PC • Double Pole



**D22022H**

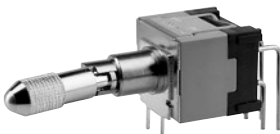
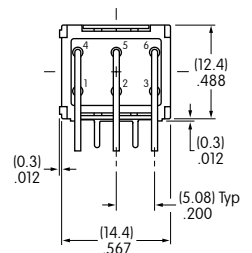
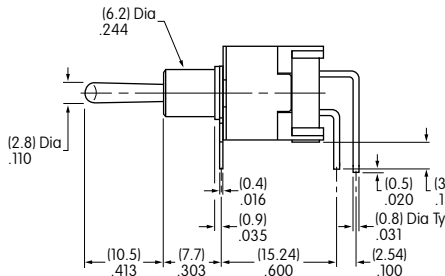
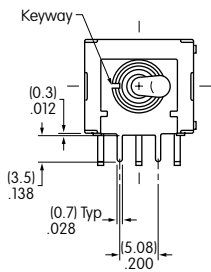

**D22022LH**

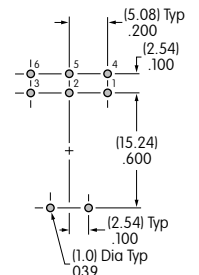
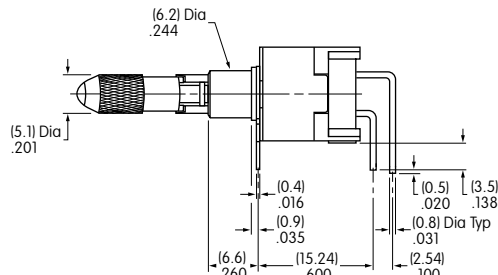
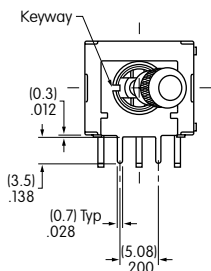

Actuator in Down Position

Rockers

Pushbuttons

Illuminated PB

Programmable

Keylocks

Rotaries

Slides

Tactiles

Tilt

Touch

Indicators

Accessories

Supplement

TYPICAL SWITCH DIMENSIONS

Vertical PC • Single Pole



D22012V



Actuator in Down Position

D22012LV

Vertical PC • Double Pole

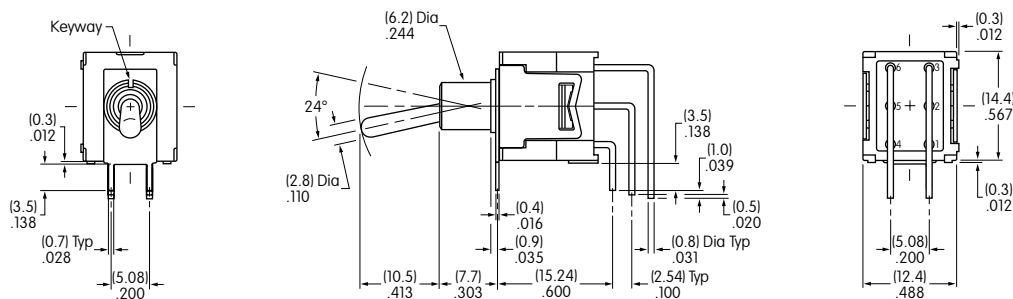

D22022V

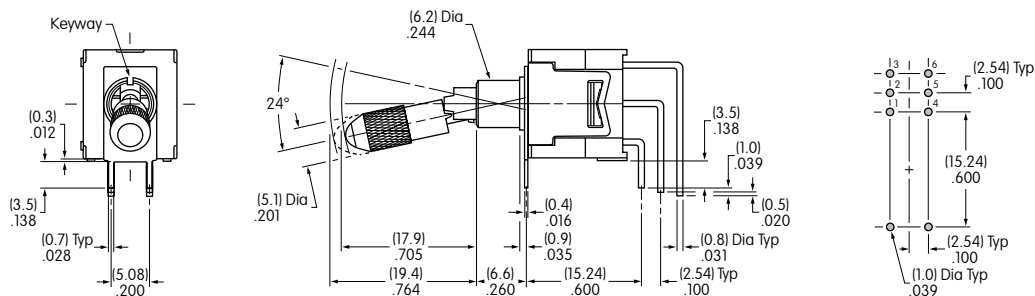

Actuator in Down Position

D22022LV

A	Toggles
	Rockers
	Pushbuttons
	Illuminated PB
	Programmable
	Keylocks
	Rotaries
	Slides
	Tactiles
	Tilt
	Touch
	Indicators
	Accessories
	Supplement



## TYPICAL SWITCH DIMENSIONS

### Vertical PC • Four Pole

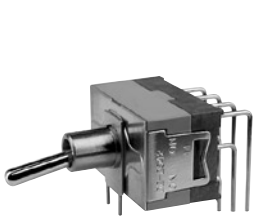

**D22042V**

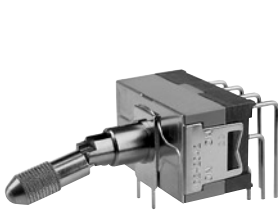

**D22042LV**

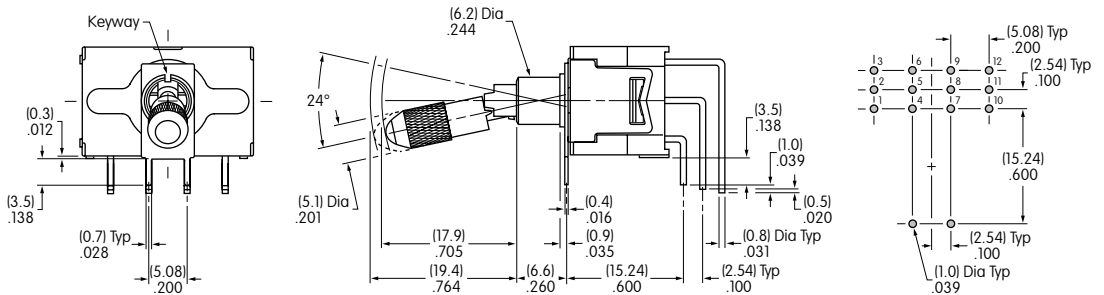

Actuator in Down Position

## STANDARD HARDWARE

## OPTIONAL

**AT513M**  
Hex Nut  
Brass with nickel plating  
2 supplied

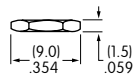
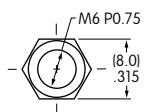

**AT507M**  
Locking Ring  
Steel with zinc/chromate  
1 supplied

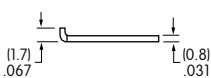
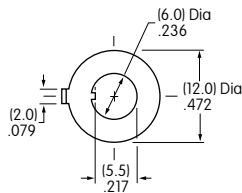

**AT509**  
Lockwasher  
Steel with zinc/chromate  
1 supplied

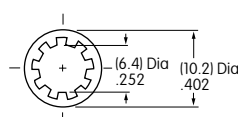

**AT501M**  
Knurled Face Nut  
Brass with chrome plating

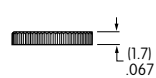
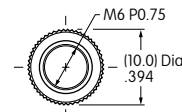

## PANEL CUTOUTS & MAXIMUM PANEL THICKNESS

**With Standard Hardware**

.087" (2.2mm) for Standard Lever

.051" (1.3mm) for Locking Lever

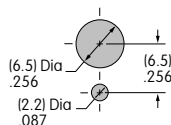

**Without Bottom Hex Nut**

.154" (3.9mm) for Standard Lever

.110" (2.8mm) for Locking Lever

**Without Locking Ring**

.118" (3.0mm) for Standard Lever

.083" (2.1mm) for Locking Lever

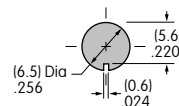

**Without Locking Ring & Bottom Hex Nut**

.185" (4.7mm) for Standard Lever

.142" (3.6mm) for Locking Lever



# Mouser Electronics

Authorized Distributor

Click to View Pricing, Inventory, Delivery & Lifecycle Information:

## NKK Switches:

[D22012B](#) [D22029B](#) [D22029H](#) [D22029LB](#) [D22029LH](#) [D22029LP](#) [D22029LV](#) [D22029V](#) [D22042B](#) [D22042LB](#)  
[D22042LP](#) [D22042LV](#) [D22042P](#) [D22042V](#) [D22012LP](#) [D22013B](#)



Компания «ЭлектроПласт» предлагает заключение долгосрочных отношений при поставках импортных электронных компонентов на взаимовыгодных условиях!

Наши преимущества:

- Оперативные поставки широкого спектра электронных компонентов отечественного и импортного производства напрямую от производителей и с крупнейших мировых складов;
- Поставка более 17-ти миллионов наименований электронных компонентов;
- Поставка сложных, дефицитных, либо снятых с производства позиций;
- Оперативные сроки поставки под заказ (от 5 рабочих дней);
- Экспресс доставка в любую точку России;
- Техническая поддержка проекта, помощь в подборе аналогов, поставка прототипов;
- Система менеджмента качества сертифицирована по Международному стандарту ISO 9001;
- Лицензия ФСБ на осуществление работ с использованием сведений, составляющих государственную тайну;
- Поставка специализированных компонентов (Xilinx, Altera, Analog Devices, Intersil, Interpoint, Microsemi, Aeroflex, Peregrine, Syfer, Eurofarad, Texas Instrument, Miteq, Cobham, E2V, MA-COM, Hittite, Mini-Circuits, General Dynamics и др.);

Помимо этого, одним из направлений компании «ЭлектроПласт» является направление «Источники питания». Мы предлагаем Вам помощь Конструкторского отдела:

- Подбор оптимального решения, техническое обоснование при выборе компонента;
- Подбор аналогов;
- Консультации по применению компонента;
- Поставка образцов и прототипов;
- Техническая поддержка проекта;
- Защита от снятия компонента с производства.



#### Как с нами связаться

**Телефон:** 8 (812) 309 58 32 (многоканальный)

**Факс:** 8 (812) 320-02-42

**Электронная почта:** [org@eplast1.ru](mailto:org@eplast1.ru)

**Адрес:** 198099, г. Санкт-Петербург, ул. Калинина, дом 2, корпус 4, литера А.