



# Dual, Audio, Log Taper Digital Potentiometers

## General Description

The MAX5408–MAX5411 dual, logarithmic taper digital potentiometers, with 32-tap points each, replace mechanical potentiometers in audio applications requiring digitally controlled resistors. The MAX5408/MAX5410 are dual potentiometers with one wiper per potentiometer. The MAX5409/MAX5411 are dual potentiometers with two wipers per potentiometer (see *Functional Diagram*). An SPI™-compatible serial interface controls the wiper positions. The MAX5408–MAX5411 have a factory-set resistance of 10kΩ per potentiometer. A zero-crossing detect feature minimizes the audible noise generated by wiper transitions. The MAX5408–MAX5411 have nominal temperature coefficients of 35ppm/°C end-to-end and 5ppm/°C ratiometric. The MAX5408–MAX5411 are available in 16-pin QSOP and 16-pin thin QFN packages and are specified over the extended temperature range (-40°C to +85°C).

## Applications

Stereo Volume Control  
Fading and Balancing Stereo Signals  
Mechanical Potentiometer Replacement

**Functional Diagram appears at end of data sheet.**  
SPI is a trademark of Motorola, Inc.

## Features

- ◆ Log Taper with 2dB Steps Between Taps
- ◆ 32-Tap Positions for Each Wiper
- ◆ Small 16-Pin QSOP/QFN Packages
- ◆ Single-Supply Voltage Operation
  - +2.7V to +3.6V (MAX5408/MAX5409)
  - +4.5V to +5.5V (MAX5410/MAX5411)
- ◆ Low 0.5μA Standby Supply Current
- ◆ Zero-Crossing Detection for Clickless Switching
- ◆ Mute Function to -90dB
- ◆ 10kΩ Fixed Resistance Value
- ◆ 3-Wire SPI-Compatible Serial Data Interface
- ◆ Power-On Reset: Wiper Goes to Maximum Attenuation
- ◆ Digital Output for Readback and Daisy-Chaining Capabilities

## Ordering Information

PART	TEMP RANGE	PIN-PACKAGE	WIPERS PER RESISTOR
MAX5408EEE	-40°C to +85°C	16 QSOP	1
MAX5408ETE	-40°C to +85°C	16 Thin QFN	1
MAX5409EEE	-40°C to +85°C	16 QSOP	2

Ordering Information continued at end of data sheet.

## Pin Configurations

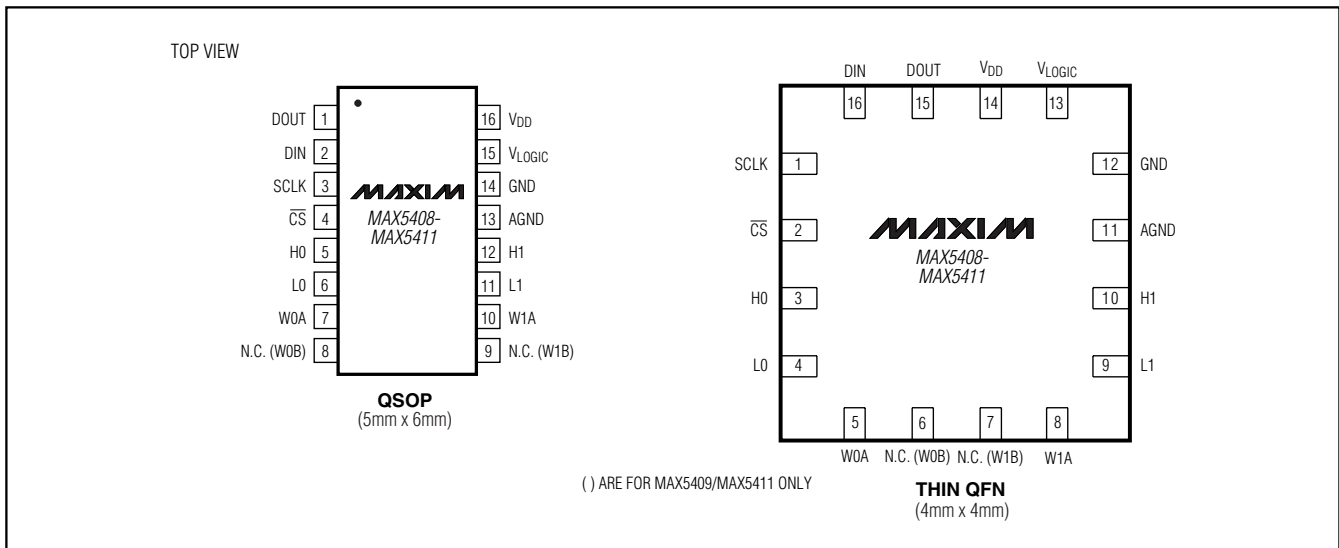

# Dual, Audio, Log Taper Digital Potentiometers

## ABSOLUTE MAXIMUM RATINGS

$V_{DD}$ ,  $V_{LOGIC}$ ,  $\overline{CS}$ , SCLK, DIN to GND ..... -0.3V to +6V  
 $H_-$ ,  $L_-$ , and  $W_-$  to GND ..... -0.3V to ( $V_{DD} + 0.3V$ )  
 DOUT to GND ..... -0.3V to ( $V_{DD} + 0.3V$ )  
 AGND to GND ..... -0.3V to +0.3V  
 Input and Output Latchup Immunity .....  $\pm 200mA$   
 Maximum Continuous Current into  $H_-$ ,  $L_-$ , and  $W_-$  .....  $\pm 500\mu A$

Continuous Power Dissipation ( $T_A = +70^\circ C$ )  
 16-Pin QSOP (derate 8.3mW/ $^\circ C$  above  $+70^\circ C$ ) ..... 666.7mW  
 16-Pin QFN (derate 18.5mW/ $^\circ C$  above  $+70^\circ C$ ) ..... 1481mW  
 Operating Temperature Range .....  $-40^\circ C$  to  $+85^\circ C$   
 Storage Temperature Range .....  $-60^\circ C$  to  $+150^\circ C$   
 Maximum Junction Temperature .....  $+150^\circ C$   
 Lead Temperature (soldering, 10s) .....  $+300^\circ C$

Stresses beyond those listed under "Absolute Maximum Ratings" may cause permanent damage to the device. These are stress ratings only, and functional operation of the device at these or any other conditions beyond those indicated in the operational sections of the specifications is not implied. Exposure to absolute maximum rating conditions for extended periods may affect device reliability.

## ELECTRICAL CHARACTERISTICS

( $V_{DD} = +2.7V$  to  $+3.6V$  (MAX5408/MAX5409),  $V_{DD} = +4.5V$  to  $+5.5V$  (MAX5410/MAX5411),  $V_{H_-} = V_{DD}$ ,  $V_{L_-} = 0$ ,  $T_A = T_{MIN}$  to  $T_{MAX}$ . Typical values are at  $T_A = +25^\circ C$ , unless otherwise specified.)

PARAMETER	SYMBOL	CONDITIONS	MIN	TYP	MAX	UNITS
End-to-End Resistance			7	10	13	k $\Omega$
Maximum Bandwidth		(Note 1) $C_{W_-} = 50pF$	100			kHz
Absolute Tolerance				$\pm 0.25$		dB
Tap-to-Tap Tolerance				$\pm 0.1$		dB
Total Harmonic Distortion + Noise	THD+N	$V_{IN} = 1V_{RMS}$ , $f = 1kHz$ , tap = -6dB		0.002		%
Channel Isolation				-100		dB
Interchannel Matching		$f = 20Hz$ to $20kHz$ , tap = -6dB		$\pm 0.5$		dB
Mute Attenuation				-90		dB
Power-Supply Rejection Ratio	PSRR			-80		dB
Wiper Resistance	$R_W$			1000	1700	$\Omega$
Wiper Capacitance	$C_W$			10		pF
Digital Clock Feedthrough		$f_{SCLK} = 20Hz$ to $20kHz$ , tap = -6dB		-90		dB
End-to-End Resistance Temperature Coefficient				35		ppm/ $^\circ C$
Ratiometric Resistance Temperature Coefficient				5		ppm/ $^\circ C$
<b>DIGITAL INPUTS (<math>V_{LOGIC} &gt; 4.5V</math>)</b>						
Input High Voltage	$V_{IH}$		2.4			V
Input Low Voltage	$V_{IL}$				0.8	V
Input Leakage Current					$\pm 1$	$\mu A$
Input Capacitance				5		pF
<b>DIGITAL INPUTS (<math>V_{LOGIC} &lt; 4.5V</math>)</b>						
Input High Voltage	$V_{IH}$		$0.7 \times V_{LOGIC}$			V
Input Low Voltage	$V_{IL}$			$0.3 \times V_{LOGIC}$		V
Input Leakage Current					$\pm 1$	$\mu A$
Input Capacitance				5		pF

# Dual, Audio, Log Taper Digital Potentiometers

MAX5408-MAX5411

## ELECTRICAL CHARACTERISTICS (continued)

( $V_{DD} = +2.7V$  to  $+3.6V$  (MAX5408/MAX5409),  $V_{DD} = +4.5V$  to  $+5.5V$  (MAX5410/MAX5411),  $V_{H\_} = V_{DD}$ ,  $V_{L\_} = 0$ ,  $T_A = T_{MIN}$  to  $T_{MAX}$ . Typical values are at  $T_A = +25^\circ C$ , unless otherwise specified.)

PARAMETER	SYMBOL	CONDITIONS	MIN	TYP	MAX	UNITS
<b>DIGITAL OUTPUT</b>						
Output High Voltage	$V_{OH}$	$I_{SOURCE} = 0.5mA$	$V_{LOGIC} - 0.5$			V
Output Low Voltage	$V_{OL}$	$I_{SINK} = 2mA$			0.4	V
<b>TIMING CHARACTERISTICS</b> (Figure 1)						
SCLK Clock Period	$t_{CP}$		100			ns
SCLK Pulse Width High	$t_{CH}$		40			ns
SCLK Pulse Width Low	$t_{CL}$		40			ns
$\overline{CS}$ Fall to SCLK Rise Setup Time	$t_{CSS}$		40			ns
SCLK Rise to $\overline{CS}$ Rise Hold Time	$t_{CSH}$		0			ns
DIN Setup Time	$t_{DS}$		40			ns
DIN Hold Time	$t_{DH}$		0			ns
SCLK Fall to DOUT Valid Propagation Delay	$t_{DO}$	$C_{LOAD} = 200pF$			80	ns
$\overline{CS}$ Rise to SCLK Rise Hold Time	$t_{CS1}$		40			ns
$\overline{CS}$ Pulse Width High	$t_{CSW}$		100			ns
Wiper Settling Time	$t_{tW}$	Zero-crossing detect disabled		1		$\mu s$
<b>POWER SUPPLIES</b>						
Supply Voltage	$V_{DD}$	MAX5408/MAX5409	2.7		3.6	V
		MAX5410/MAX5411	4.5		5.5	
Active Supply Current	$I_{DD}$	$f_{SCLK} = 2MHz$ (Note 2)			100	$\mu A$
Standby Supply Current		(Note 3)		0.2	10	
Logic Supply Voltage	$V_{LOGIC}$		2.7		5.5	V
Logic Active Supply Current	$I_{LOGIC}$	$f_{SCLK} = 2MHz$ , DOUT = floating (Note 2)			120	$\mu A$
Logic Standby Supply Current		DOUT = floating (Note 3)		0.5	10	

**Note 1:** Guaranteed by design, not production tested.

**Note 2:** Supply current measured while changing wiper position with zero crossing enabled.

**Note 3:** Supply current measured while wiper position is fixed.

# Dual, Audio, Log Taper Digital Potentiometers

## Typical Operating Characteristics

( $V_{DD} = +3V$  (MAX5408/MAX5409),  $V_{DD} = +5V$  (MAX5410/MAX5411), DO<sub>UT</sub> = floating)

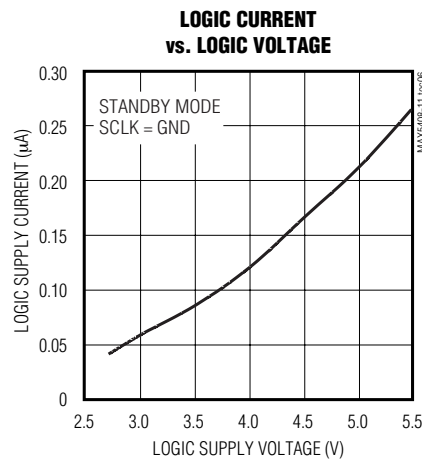
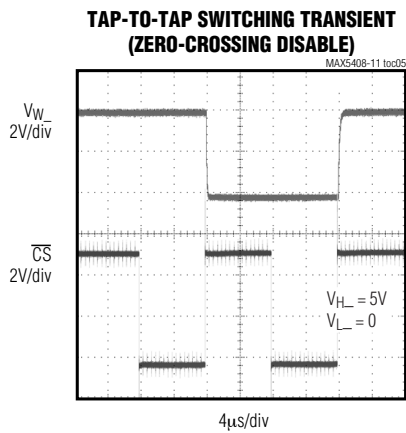
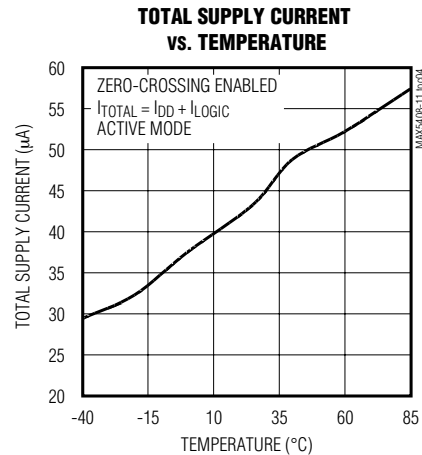
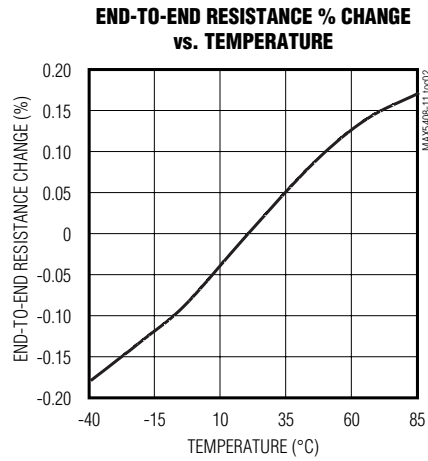
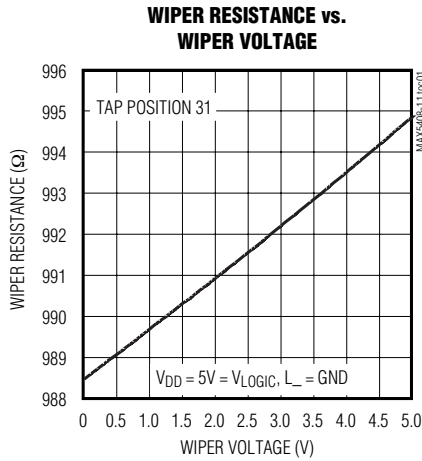

# Dual, Audio, Log Taper Digital Potentiometers

MAX5408-MAX5411

## Typical Operating Characteristics (continued)

(V<sub>DD</sub> = +3V (MAX5408/MAX5409), V<sub>DD</sub> = +5V (MAX5410/MAX5411), DOUT = floating)

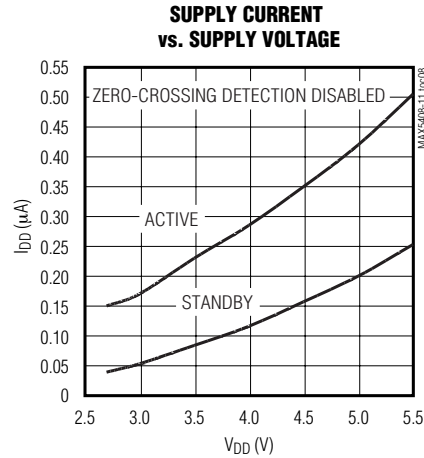
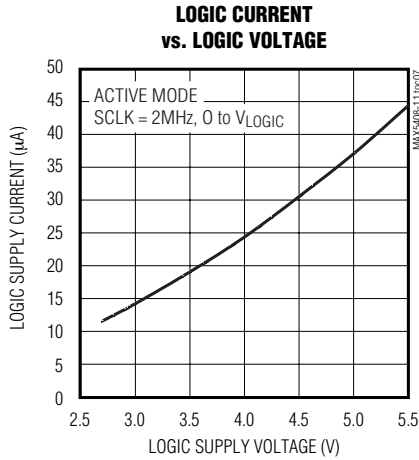

## Pin Description

PIN				NAME	FUNCTION
MAX5408/ MAX5410 (QFN)	MAX5408/ MAX5410 (QSOP)	MAX5409/ MAX5411 (QFN)	MAX5409/ MAX5411 (QSOP)		
1	3	1	3	SCLK	Serial Clock Input
2	4	2	4	CS	Chip-Select Input
3	5	3	5	H0	High Terminal of Resistor 0
4	6	4	6	L0	Low Terminal of Resistor 0
5	7	5	7	W0A	Wiper Terminal A of Resistor 0
—	—	6	8	W0B	Wiper Terminal B of Resistor 0
—	—	7	9	W1B	Wiper Terminal B of Resistor 1
8	10	8	10	W1A	Wiper Terminal A of Resistor 1
9	11	9	11	L1	Low Terminal of Resistor 1
10	12	10	12	H1	High Terminal of Resistor 1
11	13	11	13	AGND	Analog Ground
12	14	12	14	GND	Ground
13	15	13	15	VLOGIC	Digital Logic Power Supply
14	16	14	16	VDD	Analog Power Supply
15	1	15	1	DOUT	Serial Data Output
16	2	16	2	DIN	Serial Data Input
6, 7	8, 9	—	—	N.C.	No Connection. Not internally connected.

# Dual, Audio, Log Taper Digital Potentiometers

**Table 1. Serial Interface Programming Commands for MAX5408/MAX5410**

8-BIT SERIAL WORD				FUNCTION
A0	A1	A2	D4–D0	
0	0	0	5-bit DAC data	Set position of wiper W0A
0	0	1	5-bit DAC data	No change
0	1	0	5-bit DAC data	Set position of wiper W1A
0	1	1	5-bit DAC data	No change
1	0	0	4-bit mute data, D0 = “don't care”	Data for mute register (see Table 3)
1	0	1	4-bit zero-crossing detection data, D0 = “don't care”	Data for zero-crossing detection register (see Table 5)
1	1	0	00000	Readback contents of wiper register for W0A at DOUT
1	1	0	00001	No change
1	1	0	00010	Readback contents of wiper register for W1A at DOUT
1	1	0	00011	No change
1	1	0	00100	Readback contents of mute register at DOUT
1	1	0	00101	Readback contents of zero-crossing detection register at DOUT
1	1	1	D4 = 0, D3–D0 = “don't care”	Immediate update then analog power-down when zero crossing is enabled. No effect when zero crossing is disabled.

## Detailed Description

### Digital Serial Interface

An SPI-compatible serial interface controls the MAX5408–MAX5411. The input word to the device is eight bits long, composed of three address bits (A0, A1, and A2), followed by five data bits, with MSB first (see Tables 1 and 2). The first three address bits set the value of internal registers. The five data bits control the wiper position. For certain commands, some of the five data bits are “don't cares”, but must be sent to the device.

The serial data is listed in Tables 1 and 2.

The control code determines:

- Potentiometer to update or register to set.
- Data for mute register (Tables 3 and 4).
- Data for zero-crossing detection register (Tables 5 and 6).

The data bits control the position of the wiper (Table 7). A logic low on the chip-select input (CS) enables the device's serial interface. A logic high on CS disables the interface control circuitry. See Figure 1 for serial-interface timing description.



Figure 1. Serial Timing Diagram

# Dual, Audio, Log Taper Digital Potentiometers

MAX5408-MAX5411

**Table 2. Serial Interface Programming Commands for MAX5409/MAX5411**

8-BIT SERIAL WORD				FUNCTION
A0	A1	A2	D4-D0	
0	0	0	5-bit DAC data	Set position of wiper W0A
0	0	1	5-bit DAC data	Set position of wiper W0B
0	1	0	5-bit DAC data	Set position of wiper W1A
0	1	1	5-bit DAC data	Set position of wiper W1B
1	0	0	4-bit mute data, D0 = "don't care"	Data for mute register (see Table 4)
1	0	1	4-bit zero-crossing detection data, D0 = "don't care"	Data for zero-crossing detection register (see Table 6)
1	1	0	00000	Readback contents of wiper register for W0A at DOUT
1	1	0	00001	Readback contents of wiper register for W0B at DOUT
1	1	0	00010	Readback contents of wiper register for W1A at DOUT
1	1	0	00011	Readback contents of wiper register for W1B at DOUT
1	1	0	00100	Readback contents of mute register at DOUT
1	1	0	00101	Readback contents of zero-crossing detection register at DOUT
1	1	1	D4 = 0, D3-D0 = "don't care"	Analog power-down
1	1	1	D4 = 1, D3-D0 = "don't care"	Analog power-up

**Table 3. Mute Register Bit Definitions for MAX5408/MAX5410**

DATA BIT	VALUE	FUNCTION
D4	0	Set wiper W0A to preprogrammed value (-62dB on power-up)
	1	Set wiper W0A to mute (-90dB)
D3	"don't care"	No change
D2	0	Set wiper W1A to preprogrammed value (-62dB on power-up)
	1	Set wiper W1A to mute (-90dB)
D1	"don't care"	No change
D0	"don't care"	No change

**Table 4. Mute Register Bit Definitions for MAX5409/MAX5411**

DATA BIT	VALUE	FUNCTION
D4	0	Set wiper W0A to preprogrammed value (-62dB on power-up)
	1	Set wiper W0A to mute (-90dB)
D3	0	Set wiper W0B to preprogrammed value (-62dB on power-up)
	1	Set wiper W0B to mute (-90dB)
D2	0	Set wiper W1A to preprogrammed value (-62dB on power-up)
	1	Set wiper W1A to mute (-90dB)
D1	0	Set wiper W1B to preprogrammed value (-62dB on power-up)
	1	Set wiper W1B to mute (-90dB)
D0	"don't care"	No change

# Dual, Audio, Log Taper Digital Potentiometers

**Table 5. Zero-Crossing Detection Register Bit Definitions for MAX5408/MAX5410**

DATA BIT	VALUE	FUNCTION
D4	0	Disable wiper W0A zero-crossing detection circuit
	1	Enable wiper W0A zero-crossing detection circuit
D3	“don’t care”	No change
D2	0	Disable wiper W1A zero-crossing detection circuit
	1	Enable wiper W1A zero-crossing detection circuit
D1	“don’t care”	No change
D0	“don’t care”	No change

**Table 6. Zero-Crossing Detection Register Bit Definitions for MAX5409/MAX5411**

DATA BIT	VALUE	FUNCTION
D4	0	Disable wiper W0A zero-crossing detection circuit
	1	Enable wiper W0A zero-crossing detection circuit
D3	0	Disable wiper W0B zero-crossing detection circuit
	1	Enable wiper W0B zero-crossing detection circuit
D2	0	Disable wiper W1A zero-crossing detection circuit
	1	Enable wiper W1A zero-crossing detection circuit
D1	0	Disable wiper W1B zero-crossing detection circuit
	1	Enable wiper W1B zero-crossing detection circuit
D0	“don’t care”	No change

**Table 7. Attenuation and Wiper Position**

POSITION	OUTPUT LEVEL (dB)
0	0
1	-2
2	-4
3	-6
4	-8
⋮	⋮
⋮	⋮
30	-60
31	-62
MUTE	<-90

The digital output, DOUT, lags the digital input signal, DIN by 8.5 clock cycles. Force  $\overline{CS}$  high to disable DOUT, placing DOUT in three-state mode. Force  $\overline{CS}$  low to enable DOUT and disable three-state mode.

Force  $\overline{CS}$  high, after a word has been written to the MAX5408–MAX5411 to make a readback request. The next  $\overline{CS}$  low period writes the requested data to DOUT.

A readback request overwrites any previous data in the shift register. Note that the data appears at DOUT in the order: A0, A1, A2, D4, D3, D2, D1, D0. A0 will be available after the first high-to-low transition of SCLK when  $\overline{CS}$  is low. The input continues to load the shift register while data is being read out of the MAX5408–MAX5411. The input data appears at DOUT 8.5 clock cycles later. A  $\overline{CS}$  transition from low-to-high latches the input data. For any control byte, the state of SCLK must be the same for both  $\overline{CS}$  low-to-high transitions and  $\overline{CS}$  high-to-low transitions in order to preserve the data at DOUT while  $\overline{CS}$  transitions. For proper operation, ensure that the input data remains valid on both the SCLK rising and falling edges when daisy chaining multiple devices.

### Zero-Crossing Detection

The zero-crossing detection register enables the zero-crossing detect feature. The zero-crossing detect feature reduces the audible noise (“clicks and pops”) that result from wiper transitions. The wiper changes position only when the voltage at L<sub>-</sub> is the same as the voltage at H<sub>-</sub>. Each wiper has a zero-crossing and timeout



# Dual, Audio, Log Taper Digital Potentiometers

**MAX5408-MAX5411**

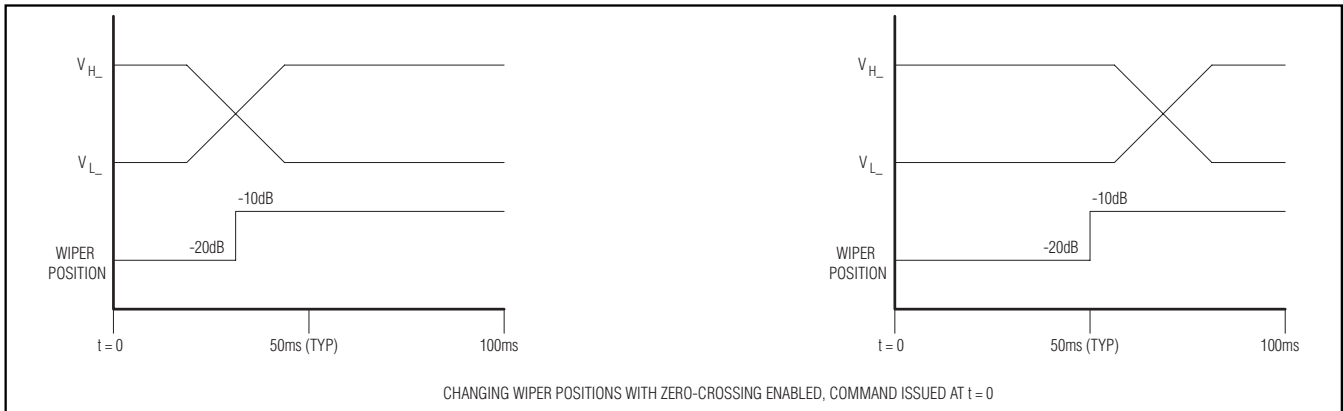

Figure 2. Zero-Crossing Timing Diagram



Figure 3. Attenuation Control

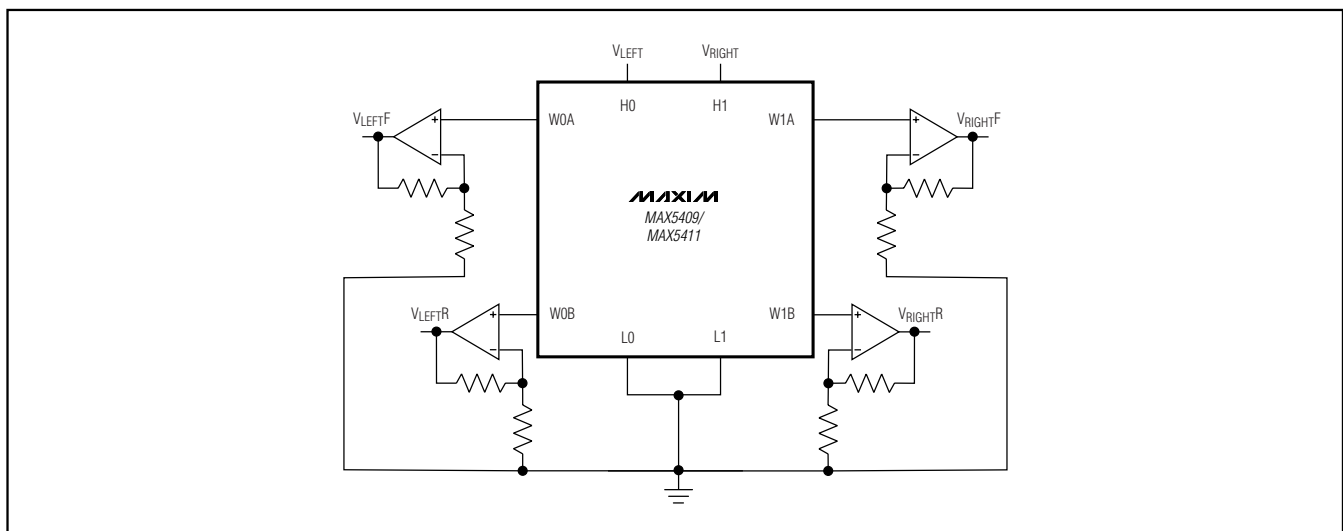

Figure 4. Stereo Volume Control with Front and Rear Fade

# Dual, Audio, Log Taper Digital Potentiometers



Figure 5. Daisy-Chaining of Serial Interfaces

circuit (see Figure 2). With zero-crossing enabled, the MAX5408-MAX5411 change wiper position after 50ms or when zero crossing is detected.

### Power-On Reset

The power-on reset (POR) feature sets all the wipers to the maximum attenuation (tap position 31, -62dB) at power-up. If either V<sub>DD</sub> or V<sub>LOGIC</sub> is zero volts, a power-on reset initiates when one of the supplies is brought back to the operating voltage.

### Mute Function

When mute is enabled, the wipers go to -90dB attenuation. When mute is disabled, the wiper returns to its position before mute was enabled. All wipers can be muted simultaneously or independently.

## Applications Information

### Attenuation Control

Figure 3 shows the application of an attenuation control. The op amps are connected in a follower configuration with a fixed gain. The digitally controlled potentiometer attenuates the input signal.

### Stereo Volume Control

Figure 4 shows the application of stereo volume control using MAX5409/MAX5411. The op amps are connected in a follower configuration with fixed gain. The digitally controlled potentiometer attenuates the input signals. The second wiper of each potentiometer controls the signal amplitude at the rear set of speakers.



Figure 6. Gain Control

### Daisy-Chaining

Figure 5 shows an application daisy-chaining the serial-interfaces of the MAX5408-MAX5411. A single-write command updates multiple devices from a single digital port in this configuration (see *Digital Serial Interface* section).

### Gain Control

Figure 6 shows the application of a gain control. **Note:** Muting the potentiometer creates unpredictable behavior at the output of the op amp, and may seriously degrade the performance of the op amp.

## Ordering Information (continued)

PART	TEMP RANGE	PIN-PACKAGE	WIPERS PER RESISTOR
MAX5409ETE	-40°C to +85°C	16 Thin QFN	2
<b>MAX5410EEE</b>	-40°C to +85°C	16 QSOP	1
MAX5410ETE	-40°C to +85°C	16 Thin QFN	1
<b>MAX5411EEE</b>	-40°C to +85°C	16 QSOP	2
MAX5411ETE	-40°C to +85°C	16 Thin QFN	2

## Chip Information

TRANSISTOR COUNT: 12,875

PROCESS: BiCMOS

# Dual, Audio, Log Taper Digital Potentiometers

## Functional Diagram

**MAX5408-MAX5411**

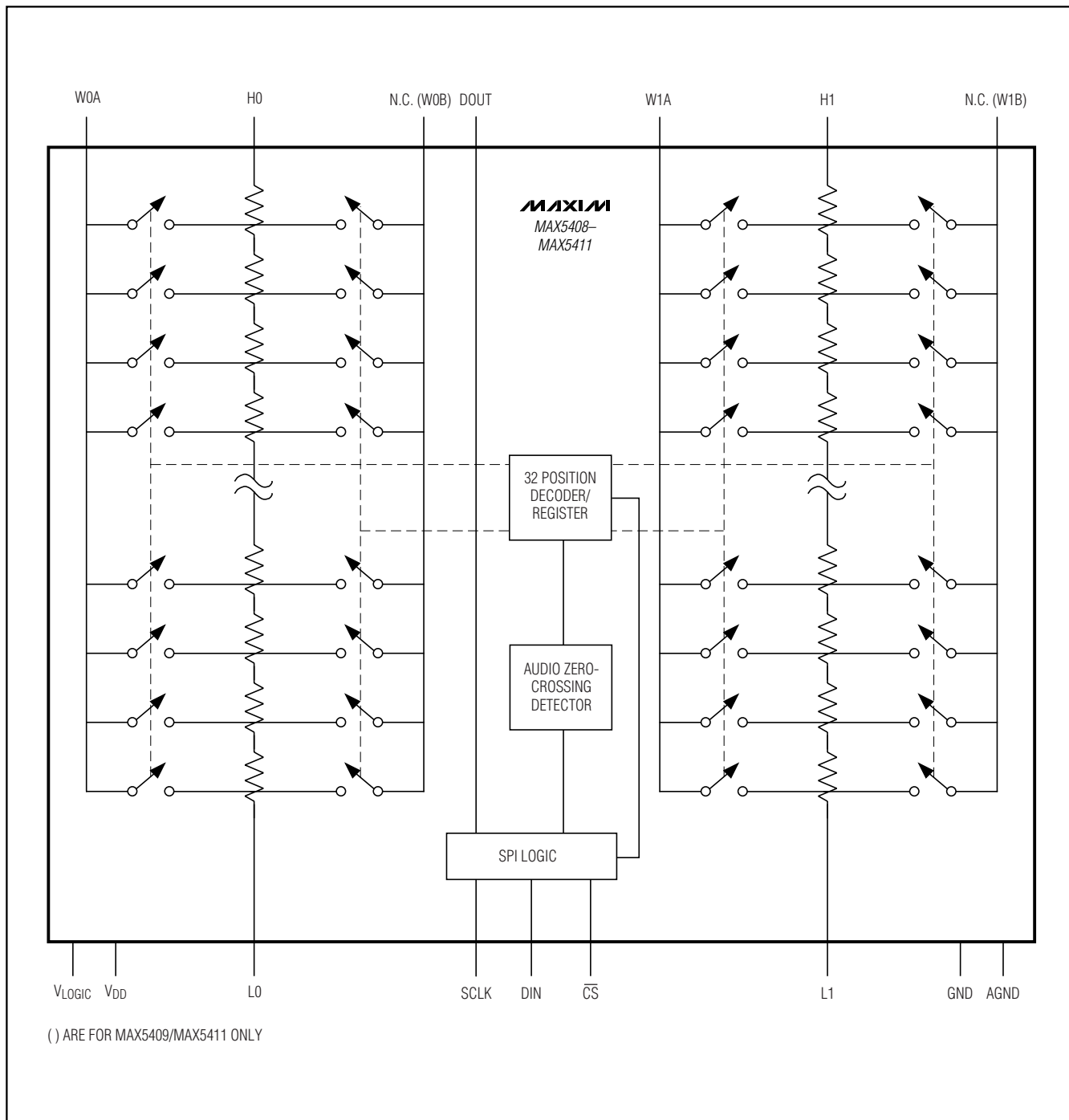

# Dual, Audio, Log Taper Digital Potentiometers

## Package Information

(The package drawing(s) in this data sheet may not reflect the most current specifications. For the latest package outline information, go to [www.maxim-ic.com/packages](http://www.maxim-ic.com/packages).)



**DALLAS SEMICONDUCTOR** **MAXIM**  
 PROPRIETARY INFORMATION  
 TITLE PACKAGE OUTLINE  
 12, 16, 20, 24L THIN OFN, 4x4x0.8mm  
 APPROVAL DOCUMENT CONTROL NO. 21-0139 REV. C 1/2

COMMON DIMENSIONS												
PKG	12L 4x4			16L 4x4			20L 4x4			24L 4x4		
REF.	MIN.	NOM.	MAX.	MIN.	NOM.	MAX.	MIN.	NOM.	MAX.	MIN.	MAX.	
A	0.70	0.75	0.80	0.70	0.75	0.80	0.70	0.75	0.80	0.70	0.80	
At	0.0	0.02	0.05	0.0	0.02	0.05	0.0	0.02	0.05	0.0	0.05	
A2	0.20 REF			0.20 REF			0.20 REF			0.20 REF		
b	0.25	0.30	0.35	0.25	0.30	0.35	0.25	0.25	0.30	0.18	0.23	
D	3.90	4.00	4.10	3.90	4.00	4.10	3.90	4.00	4.10	3.90	4.00	
E	3.90	4.00	4.10	3.90	4.00	4.10	3.90	4.00	4.10	3.90	4.00	
e	0.80 BSC.			0.65 BSC.			0.50 BSC.			0.50 BSC.		
k	0.25	-	-	0.25	-	-	0.25	-	-	0.25	-	
L	0.45	0.55	0.65	0.45	0.55	0.65	0.45	0.55	0.65	0.30	0.40	
N	12			16			20			24		
ND	3			4			5			6		
NE	3			4			5			6		
JeDEC Ver.	WGGB			WGGC			WGGB-1			WGGB-2		

EXPOSED PAD VARIATIONS							
PKG. CODES	D2			E2			DOWN BONDS ALLOWED
	MIN.	NOM.	MAX.	MIN.	NOM.	MAX.	
T1244-2	1.95	2.10	2.25	1.95	2.10	2.25	NO
T1244-3	1.95	2.10	2.25	1.95	2.10	2.25	YES
T1244-4	1.95	2.10	2.25	1.95	2.10	2.25	NO
T1644-2	1.95	2.10	2.25	1.95	2.10	2.25	NO
T1644-3	1.95	2.10	2.25	1.95	2.10	2.25	YES
T1644-4	1.95	2.10	2.25	1.95	2.10	2.25	NO
T2044-1	1.95	2.10	2.25	1.95	2.10	2.25	NO
T2044-2	1.95	2.10	2.25	1.95	2.10	2.25	YES
T2044-3	1.95	2.10	2.25	1.95	2.10	2.25	NO
T2444-1	2.45	2.60	2.63	2.45	2.60	2.63	NO
T2444-2	1.95	2.10	2.25	1.95	2.10	2.25	YES
T2444-3	2.45	2.60	2.63	2.45	2.60	2.63	YES
T2444-4	2.45	2.60	2.63	2.45	2.60	2.63	NO

NOTES:  
 1. DIMENSIONING & TOLERANCING CONFORM TO ASME Y14.5M-1994.  
 2. ALL DIMENSIONS ARE IN MILLIMETERS. ANGLES ARE IN DEGREES.  
 3. N IS THE TOTAL NUMBER OF TERMINALS.  
 4. THE TERMINAL #1 IDENTIFIER AND TERMINAL NUMBERING CONVENTION SHALL CONFORM TO JEDEC 95-1 SFP-012. DETAILS OF TERMINAL #1 IDENTIFIER ARE OPTIONAL, BUT MUST BE LOCATED WITHIN THE ZONE INDICATED. THE TERMINAL #1 IDENTIFIER MAY BE EITHER A MOLD OR MARKED FEATURE.  
 5. DIMENSION b APPLIES TO METALLIZED TERMINAL AND IS MEASURED BETWEEN 0.25 mm AND 0.30 mm FROM TERMINAL TIP.  
 6. ND AND NE REFER TO THE NUMBER OF TERMINALS ON EACH D AND E SIDE RESPECTIVELY.  
 7. DEPOPULATION IS POSSIBLE IN A SYMMETRICAL FASHION.  
 8. COPLANARITY APPLIES TO THE EXPOSED HEAT SINK SLUG AS WELL AS THE TERMINALS.  
 9. DRAWING CONFORMS TO JEDEC MO220, EXCEPT FOR T2444-1, T2444-3 AND T2444-4.

**DALLAS SEMICONDUCTOR** **MAXIM**  
 PROPRIETARY INFORMATION  
 TITLE PACKAGE OUTLINE  
 12, 16, 20, 24L THIN OFN, 4x4x0.8mm  
 APPROVAL DOCUMENT CONTROL NO. 21-0139 REV. C 2/2

# Dual, Audio, Log Taper Digital Potentiometers

## Package Information (continued)

(The package drawing(s) in this data sheet may not reflect the most current specifications. For the latest package outline information, go to [www.maxim-ic.com/packages](http://www.maxim-ic.com/packages).)

MAX5408-MAX5411

DIM	INCHES		MILLIMETERS	
	MIN	MAX	MIN	MAX
A	.061	.068	1.55	1.73
A1	.004	.0098	0.102	0.249
A2	.055	.061	1.40	1.55
B	.008	.012	0.20	0.30
C	.0075	.0098	0.191	0.249
D	SEE VARIATIONS			
E	.150	.157	3.81	3.99
e	.025 BSC		0.635 BSC	
H	.230	.244	5.84	6.20
h	.010	.016	0.25	0.41
L	.016	.035	0.41	0.89
N	SEE VARIATIONS			
α	0°	8°	0°	8°

DIM	INCHES		MILLIMETERS		N
	MIN.	MAX.	MIN.	MAX.	
D	.189	.196	4.80	4.98	16 AB
S	.0020	.0070	0.05	0.18	
D	.337	.344	8.56	8.74	20 AD
S	.0500	.0550	1.270	1.397	
D	.337	.344	8.56	8.74	24 AE
S	.0250	.0300	0.635	0.762	
D	.386	.393	9.80	9.98	28 AF
S	.0250	.0300	0.635	0.762	

NOTES:  
 1). D & E DO NOT INCLUDE MOLD FLASH OR PROTRUSIONS.  
 2). MOLD FLASH OR PROTRUSIONS NOT TO EXCEED .006" PER SIDE.  
 3). CONTROLLING DIMENSIONS: INCHES.  
 4). MEETS JEDEC MO137.

**DALLAS SEMICONDUCTOR** **MAXIM**

PROPRIETARY INFORMATION

TITLE: PACKAGE OUTLINE, QSOP .150", .025" LEAD PITCH

APPROVAL	DOCUMENT CONTROL NO. 21-0055	REV. E	1/1
----------	---------------------------------	-----------	-----

Maxim cannot assume responsibility for use of any circuitry other than circuitry entirely embodied in a Maxim product. No circuit patent licenses are implied. Maxim reserves the right to change the circuitry and specifications without notice at any time.

**Maxim Integrated Products, 120 San Gabriel Drive, Sunnyvale, CA 94086 408-737-7600** \_\_\_\_\_ **13**



Компания «ЭлектроПласт» предлагает заключение долгосрочных отношений при поставках импортных электронных компонентов на взаимовыгодных условиях!

Наши преимущества:

- Оперативные поставки широкого спектра электронных компонентов отечественного и импортного производства напрямую от производителей и с крупнейших мировых складов;
- Поставка более 17-ти миллионов наименований электронных компонентов;
- Поставка сложных, дефицитных, либо снятых с производства позиций;
- Оперативные сроки поставки под заказ (от 5 рабочих дней);
- Экспресс доставка в любую точку России;
- Техническая поддержка проекта, помощь в подборе аналогов, поставка прототипов;
- Система менеджмента качества сертифицирована по Международному стандарту ISO 9001;
- Лицензия ФСБ на осуществление работ с использованием сведений, составляющих государственную тайну;
- Поставка специализированных компонентов (Xilinx, Altera, Analog Devices, Intersil, Interpoint, Microsemi, Aeroflex, Peregrine, Syfer, Eurofarad, Texas Instrument, Miteq, Cobham, E2V, MA-COM, Hittite, Mini-Circuits, General Dynamics и др.);

Помимо этого, одним из направлений компании «ЭлектроПласт» является направление «Источники питания». Мы предлагаем Вам помощь Конструкторского отдела:

- Подбор оптимального решения, техническое обоснование при выборе компонента;
- Подбор аналогов;
- Консультации по применению компонента;
- Поставка образцов и прототипов;
- Техническая поддержка проекта;
- Защита от снятия компонента с производства.



#### Как с нами связаться

**Телефон:** 8 (812) 309 58 32 (многоканальный)

**Факс:** 8 (812) 320-02-42

**Электронная почта:** [org@eplast1.ru](mailto:org@eplast1.ru)

**Адрес:** 198099, г. Санкт-Петербург, ул. Калинина, дом 2, корпус 4, литера А.