

DATA SHEET

TRANSIENT VOLTAGE SUPPRESSORS

AC/DC POWER SUPPLY

P4SMA series

RoHS compliant & Halogen free



Product specification— April 29, 2019 V.0



Transient Voltage Suppressors (TVS) Data Sheet

Features

- For surface mounted applications in order to optimize board space
- Low profile package
- Glass passivated junction
- Low inductance
- Excellent clamping capability
- 400W peak pulse power capability at 10/1000 μ s waveform, repetition rate (duty cycle): 0.01%
- Fast response time
- Typical I_R less than 1 μ A above 10V
- High Temperature soldering: 260 $^{\circ}$ C/10 seconds at terminals
- Plastic package has underwriters laboratory flammability 94V-0
- Meets MSL level 1, per J-STD-020
- Safety certification: UL: E244458



Mechanical Data

- Case: JEDEC DO-214AC. Molded plastic over glass passivated junction
- Terminal: Solder plated, solderable per MIL-STD-750, Method 2026
- Polarity: Color band denotes cathode except bi-directional models
- Standard Packaging: 12mm tape (EIA STD RS-481)
- Weight: 0.07g

Applications

- I/O interface
- AC/DC power supply
- Low frequency signal transmission line (RS232, RS485, etc.)

Maximum Ratings and Characteristics

Ratings at 25 $^{\circ}$ C ambient temperature unless otherwise specified.

| Rating | Symbol | Value | Units |
|---|-----------------|-------------|----------------|
| Peak pulse power dissipation at 10/1000 μ s waveform (Note1, Note2, Fig.1) | P_{PPM} | Minimum 400 | Watts |
| Peak pulse current of at 10/1000 μ s waveform (Note 1, Fig.3) | I_{PPM} | See Table | Amps |
| Steady state power dissipation at $T_A=50^{\circ}$ C (Fig.5) | $P_{M(AV)}$ | 3.3 | Watts |
| Peak forward surge current, 8.3ms single half sine-wave superimposed on rated load, (JEDEC Method) (Note3, Fig.6) | I_{FSM} | 40 | Amps |
| Operating junction and Storage Temperature Range. | T_J, T_{STG} | -65 to +150 | $^{\circ}$ C |
| Typical thermal resistance junction to lead | $R_{\theta JL}$ | 30 | $^{\circ}$ C/W |
| Typical thermal resistance junction to ambient | $R_{\theta JA}$ | 120 | $^{\circ}$ C/W |

Notes: 1. Non-repetitive current pulse, per Fig.3 and derated above $T_A=25^{\circ}$ C per Fig.2.

2. Mounted on 5.0mm \times 5.0mm (0.03mm thick) copper pads to each terminal.

3. 8.3ms single half sine-wave, or equivalent square wave, duty cycle=4 pulses per minutes maximum.

Dimensions (SMA/DO-214AC)

| | Symbol | Millimeters | | Inches | |
|----|--------|-------------|-------|--------|------|
| | | Min. | Max. | Min. | Max. |
| L | 3.99 | 4.50 | 0.157 | 0.177 | |
| D | 2.54 | 2.79 | 0.100 | 0.110 | |
| D1 | 1.25 | 1.65 | 0.049 | 0.065 | |
| T | 4.93 | 5.28 | 0.194 | 0.208 | |
| T1 | 0.76 | 1.52 | 0.030 | 0.060 | |
| d | - | 0.203 | - | 0.008 | |
| H | 2.00 | 2.50 | 0.079 | 0.098 | |
| H1 | 1.98 | 2.29 | 0.078 | 0.090 | |

Part Number Code

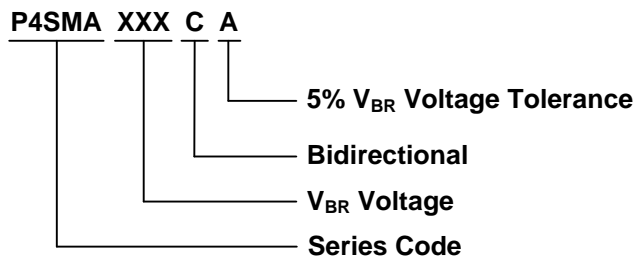

Ordering Code for different package

7 inch reel package: Add suffix "/TR7" at the end of the part number, such as P4SMA100A/TR7

13 inch reel package: Add suffix "/TR13" at the end of the part number, such as P4SMA150CA/TR13

Electrical Characteristics (T_A=25°C)

| Part Number | | Device Marking Code | | Reverse Stand-Off Voltage | Breakdown Voltage @I _T | Test Current | Maximum Clamping Voltage @I _{PP} | Peak Pulse Current | Reverse Leakage @V _{RWM} |
|----------------|---------------|---------------------|------|---------------------------|-----------------------------------|---------------------|---|---------------------|-----------------------------------|
| Unidirectional | Bidirectional | UNI | BI | V _{RWM} (V) | V _{BR} (V) | I _T (mA) | V _C (V) | I _{PP} (A) | I _R (μA) |
| P4SMA6.8A | P4SMA6.8CA | 6V8A | 6V8C | 5.80 | 6.45~7.14 | 10 | 10.5 | 39.0 | 1000 |
| P4SMA7.5A | P4SMA7.5CA | 7V5A | 7V5C | 6.40 | 7.13~7.88 | 10 | 11.3 | 36.3 | 500 |
| P4SMA8.2A | P4SMA8.2CA | 8V2A | 8V2C | 7.02 | 7.79~8.61 | 10 | 12.1 | 33.9 | 200 |
| P4SMA9.1A | P4SMA9.1CA | 9V1A | 9V1C | 7.78 | 8.65~9.55 | 1 | 13.4 | 30.6 | 50 |
| P4SMA10A | P4SMA10CA | 10A | 10C | 8.55 | 9.50~10.50 | 1 | 14.5 | 28.3 | 10 |
| P4SMA11A | P4SMA11CA | 11A | 11C | 9.40 | 10.50~11.60 | 1 | 15.6 | 26.3 | 5 |
| P4SMA12A | P4SMA12CA | 12A | 12C | 10.20 | 11.40~12.60 | 1 | 16.7 | 24.6 | 5 |
| P4SMA13A | P4SMA13CA | 13A | 13C | 11.10 | 12.40~13.70 | 1 | 18.2 | 22.5 | 1 |
| P4SMA15A | P4SMA15CA | 15A | 15C | 12.80 | 14.30~15.80 | 1 | 21.2 | 19.3 | 1 |
| P4SMA16A | P4SMA16CA | 16A | 16C | 13.60 | 15.20~16.80 | 1 | 22.5 | 18.2 | 1 |
| P4SMA18A | P4SMA18CA | 18A | 18C | 15.30 | 17.10~18.90 | 1 | 25.2 | 16.1 | 1 |
| P4SMA20A | P4SMA20CA | 20A | 20C | 17.10 | 19.00~21.00 | 1 | 27.7 | 14.8 | 1 |
| P4SMA22A | P4SMA22CA | 22A | 22C | 18.80 | 20.90~23.10 | 1 | 30.6 | 13.4 | 1 |

Transient Voltage Suppressors P4SMA

| Part Number | | Device Marking Code | | Reverse Stand-Off Voltage | Breakdown Voltage @ I_T | Test Current | Maximum Clamping Voltage @ I_{PP} | Peak Pulse Current | Reverse Leakage @ V_{RWM} |
|----------------|---------------|---------------------|------|---------------------------|---------------------------|--------------|-------------------------------------|--------------------|-----------------------------|
| Unidirectional | Bidirectional | UNI | BI | $V_{RWM}(V)$ | $V_{BR}(V)$ | $I_T(mA)$ | $V_C(V)$ | $I_{PP}(A)$ | $I_R(\mu A)$ |
| P4SMA24A | P4SMA24CA | 24A | 24C | 20.50 | 22.80~25.20 | 1 | 33.2 | 12.3 | 1 |
| P4SMA27A | P4SMA27CA | 27A | 27C | 23.10 | 25.70~28.40 | 1 | 37.5 | 10.9 | 1 |
| P4SMA30A | P4SMA30CA | 30A | 30C | 25.60 | 28.50~31.50 | 1 | 41.4 | 9.9 | 1 |
| P4SMA33A | P4SMA33CA | 33A | 33C | 28.20 | 31.40~34.70 | 1 | 45.7 | 9.0 | 1 |
| P4SMA36A | P4SMA36CA | 36A | 36C | 30.80 | 34.20~37.80 | 1 | 49.9 | 8.2 | 1 |
| P4SMA39A | P4SMA39CA | 39A | 39C | 33.30 | 37.10~41.00 | 1 | 53.9 | 7.6 | 1 |
| P4SMA43A | P4SMA43CA | 43A | 43C | 36.80 | 40.90~45.20 | 1 | 59.3 | 6.9 | 1 |
| P4SMA47A | P4SMA47CA | 47A | 47C | 40.20 | 44.70~49.40 | 1 | 64.8 | 6.3 | 1 |
| P4SMA51A | P4SMA51CA | 51A | 51C | 43.60 | 48.50~53.60 | 1 | 70.1 | 5.8 | 1 |
| P4SMA56A | P4SMA56CA | 56A | 56C | 47.80 | 53.20~58.80 | 1 | 77.0 | 5.3 | 1 |
| P4SMA62A | P4SMA62CA | 62A | 62C | 53.00 | 58.90~65.10 | 1 | 85.0 | 4.8 | 1 |
| P4SMA68A | P4SMA68CA | 68A | 68C | 58.10 | 64.60~71.40 | 1 | 92.0 | 4.5 | 1 |
| P4SMA75A | P4SMA75CA | 75A | 75C | 64.10 | 71.30~78.80 | 1 | 103.0 | 4.0 | 1 |
| P4SMA82A | P4SMA82CA | 82A | 82C | 70.10 | 77.90~86.10 | 1 | 113.0 | 3.6 | 1 |
| P4SMA91A | P4SMA91CA | 91A | 91C | 77.80 | 86.50~95.50 | 1 | 125.0 | 3.3 | 1 |
| P4SMA100A | P4SMA100CA | 100A | 100C | 85.50 | 95.00~105.00 | 1 | 137.0 | 3.0 | 1 |
| P4SMA110A | P4SMA110CA | 110A | 110C | 94.00 | 105.00~116.00 | 1 | 152.0 | 2.7 | 1 |
| P4SMA120A | P4SMA120CA | 120A | 120C | 102.00 | 114.00~126.00 | 1 | 165.0 | 2.5 | 1 |
| P4SMA130A | P4SMA130CA | 130A | 130C | 111.00 | 124.00~137.0 | 1 | 179.0 | 2.3 | 1 |
| P4SMA150A | P4SMA150CA | 150A | 150C | 128.00 | 143.00~158.0 | 1 | 207.0 | 2.0 | 1 |
| P4SMA160A | P4SMA160CA | 160A | 160C | 136.00 | 152.00~168.0 | 1 | 219.0 | 1.9 | 1 |
| P4SMA170A | P4SMA170CA | 170A | 170C | 145.00 | 162.00~179.0 | 1 | 234.0 | 1.8 | 1 |
| P4SMA180A | P4SMA180CA | 180A | 180C | 154.00 | 171.00~189.0 | 1 | 246.0 | 1.7 | 1 |
| P4SMA200A | P4SMA200CA | 200A | 200C | 171.00 | 190.00~210.0 | 1 | 274.0 | 1.5 | 1 |
| P4SMA220A | P4SMA220CA | 220A | 220C | 185.00 | 209.00~231.0 | 1 | 328.0 | 1.3 | 1 |
| P4SMA250A | P4SMA250CA | 250A | 250C | 214.00 | 237.00~263.0 | 1 | 344.0 | 1.2 | 1 |
| P4SMA300A | P4SMA300CA | 300A | 300C | 256.00 | 285.00~315.0 | 1 | 414.0 | 1.0 | 1 |
| P4SMA350A | P4SMA350CA | 350A | 350C | 300.00 | 332.00~368.0 | 1 | 482.0 | 0.9 | 1 |
| P4SMA400A | P4SMA400CA | 400A | 400C | 342.00 | 380.00~420.0 | 1 | 548.0 | 0.8 | 1 |
| P4SMA440A | P4SMA440CA | 440A | 440C | 376.00 | 418.00~462.0 | 1 | 602.0 | 0.7 | 1 |
| P4SMA480A | P4SMA480CA | 480A | 480C | 408.00 | 456.00~504.0 | 1 | 658.0 | 0.6 | 1 |
| P4SMA510A | P4SMA510CA | 510A | 510C | 434.00 | 485.00~535.0 | 1 | 698.0 | 0.6 | 1 |
| P4SMA530A | P4SMA530CA | 530A | 530C | 450.00 | 503.50~556.5 | 1 | 725.0 | 0.6 | 1 |
| P4SMA540A | P4SMA540CA | 540A | 540C | 459.00 | 513.00~567.0 | 1 | 740.0 | 0.5 | 1 |
| P4SMA550A | P4SMA550CA | 550A | 550C | 467.00 | 522.50~577.5 | 1 | 760.0 | 0.5 | 1 |

Ratings and Characteristic Curves ($T_A=25^\circ\text{C}$ unless otherwise noted)

Figure 1. Peak Pulse Power Rating Curve

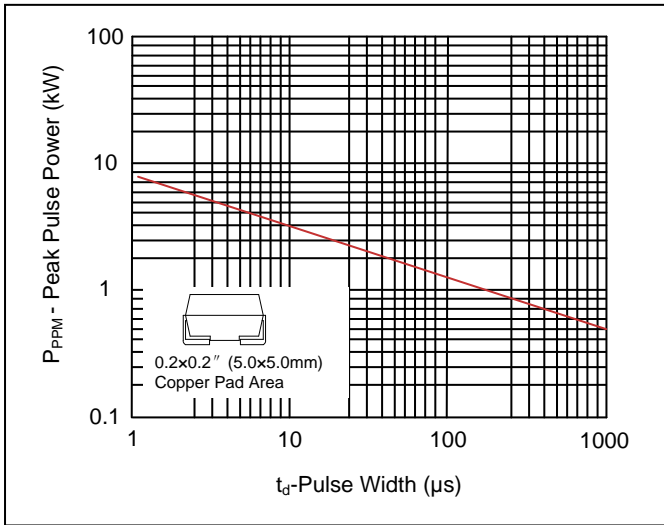

Figure 2. Pulse Derating Curve

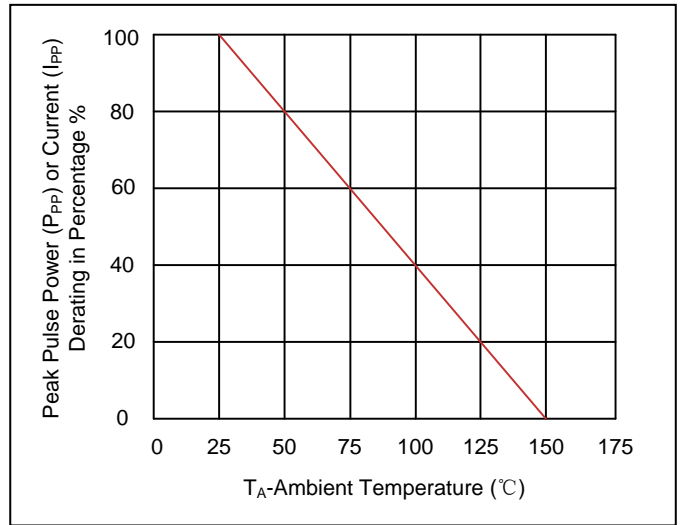

Figure 3. Pulse Waveform

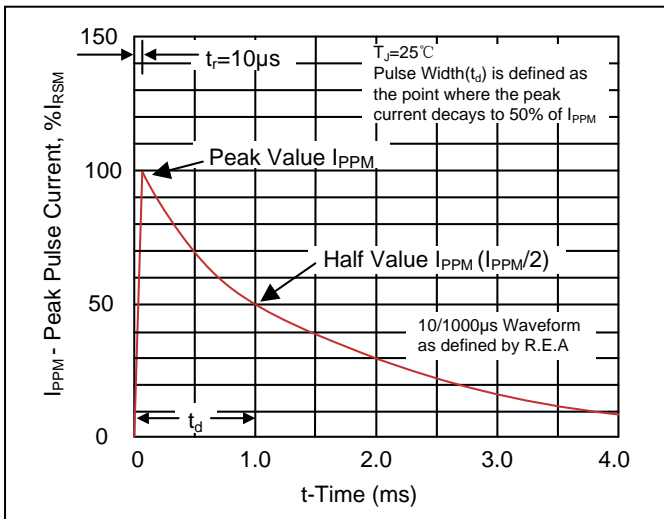

Figure 4. Typical Junction Capacitance

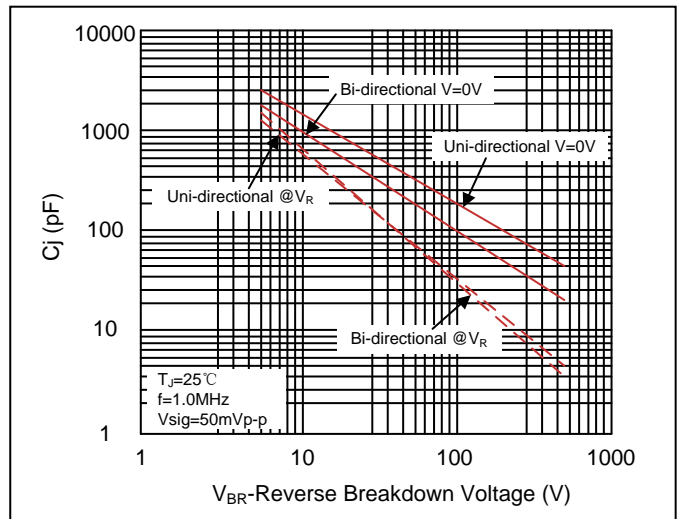

Figure 5. Steady State Power Dissipation Derating Curve

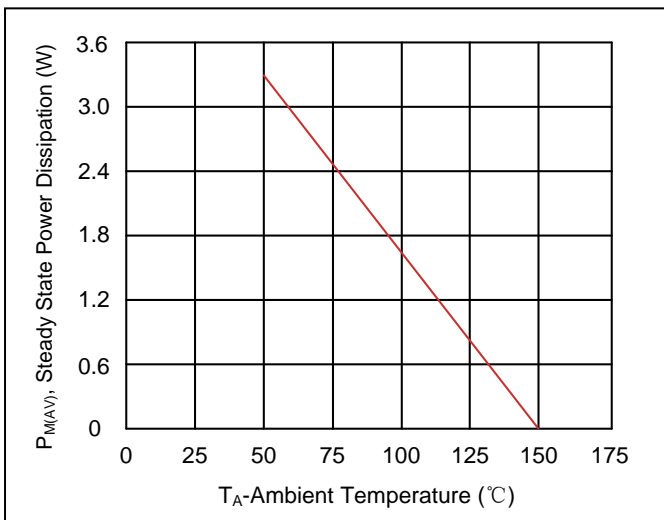
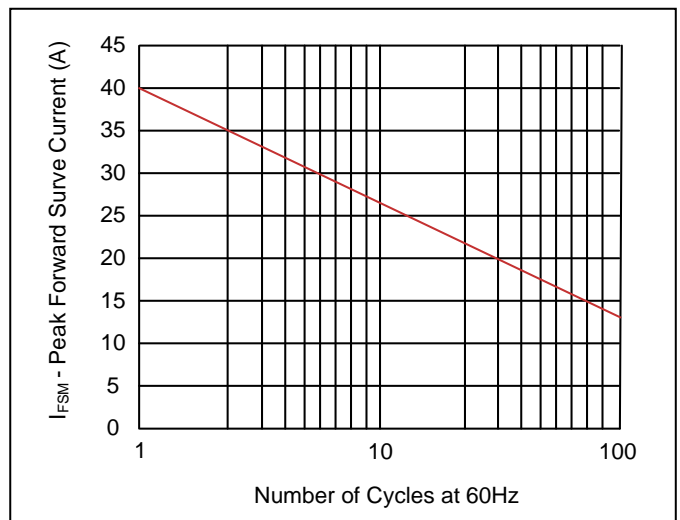
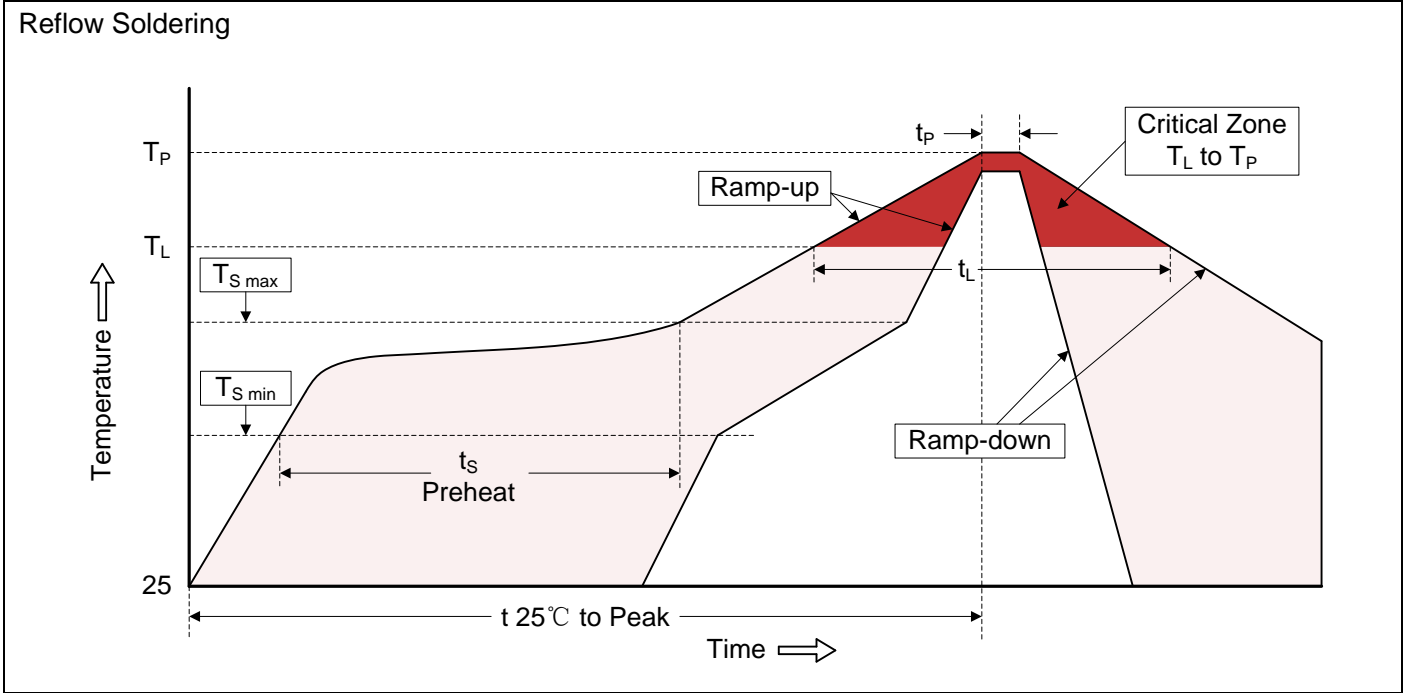

Figure 6. Maximum Non-Repetitive Forward Surge Current Uni-Directional Only



Recommended Soldering Conditions



Recommended Conditions

| Profile Feature | Pb-Free Assembly |
|--|------------------|
| Average ramp-up rate (T_L to T_P) | 3°C/second max. |
| Preheat | |
| -Temperature Min ($T_{S\ min}$) | 150°C |
| -Temperature Max ($T_{S\ max}$) | 200°C |
| -Time (min to max) (t_s) | 60-180 seconds |
| $T_{S\ max}$ to T_L | |
| -Ramp-up Rate | 3°C/second max. |
| Time maintained above: | |
| -Temperature (T_L) | 217°C |
| -Time (t_L) | 60-150 seconds |
| Peak Temperature (T_P) | 260°C |
| Time within 5°C of actual Peak Temperature (t_p) | 20-40 seconds |
| Ramp-down Rate | 6°C/second max. |
| Time 25°C to Peak Temperature | 8 minutes max. |

Marking Code

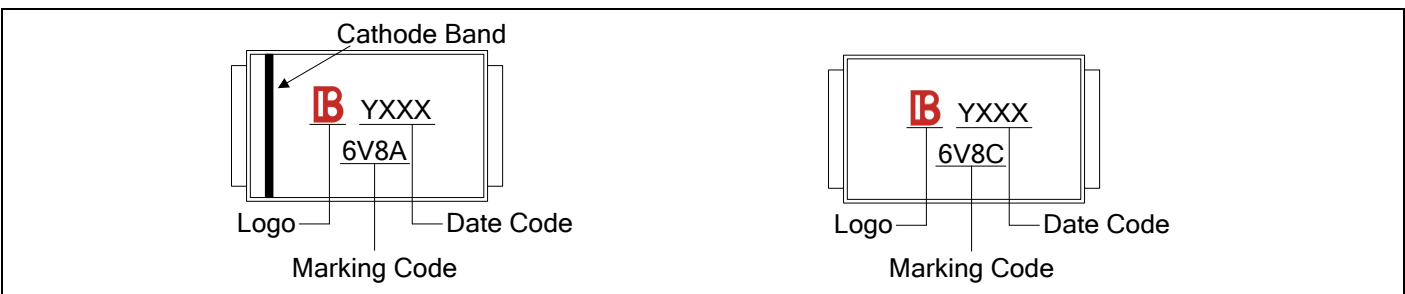

Packaging

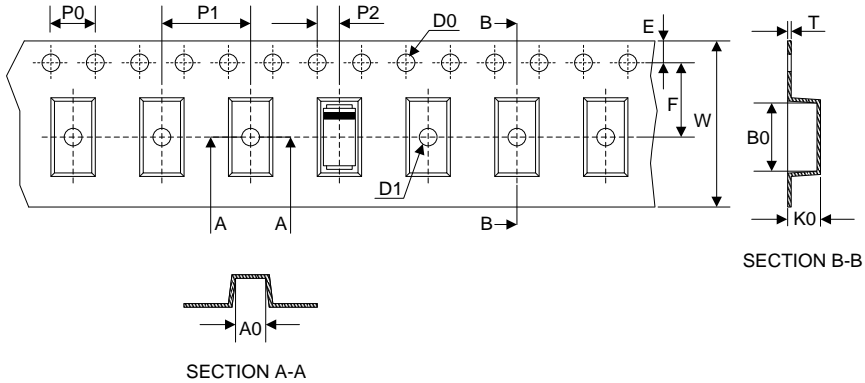
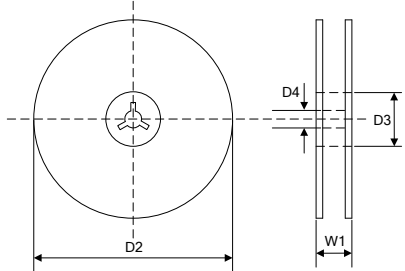
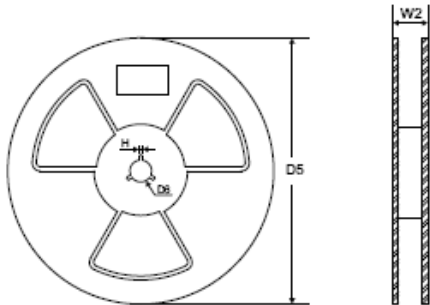
| Tape | Symbol | Dimension (mm) |
|---|---|----------------|
|  | W | 12.00±0.20 |
| | P0 | 4.00±0.10 |
| | P1 | 4.00±0.10 |
| | P2 | 2.00±0.10 |
| | D0 | Φ1.5±0.10 |
| | D1 | Φ1.5±0.10 |
| | E | 1.75±0.10 |
| | F | 5.50±0.05 |
| | A0 | 2.79±0.10 |
| | B0 | 5.33±0.10 |
| | K0 | 2.55±0.15 |
| | T | 0.25±0.05 |
| | <p>7" Reel</p>  | D2 |
| D3 | | Φ50.0Min. |
| D4 | | Φ13.0±0.5 |
| W1 | | 16.0±2.0 |
| Quantity: 1000PCS | | |
| <p>13" Reel</p>  | D5 | Φ330.0±2.0 |
| | D6 | Φ13.5±0.5 |
| | H | 2.5±1.0 |
| | W2 | 16.0±2.0 |
| | Quantity: 5000PCS | |



Компания «ЭлектроПласт» предлагает заключение долгосрочных отношений при поставках импортных электронных компонентов на взаимовыгодных условиях!

Наши преимущества:

- Оперативные поставки широкого спектра электронных компонентов отечественного и импортного производства напрямую от производителей и с крупнейших мировых складов;
- Поставка более 17-ти миллионов наименований электронных компонентов;
- Поставка сложных, дефицитных, либо снятых с производства позиций;
- Оперативные сроки поставки под заказ (от 5 рабочих дней);
- Экспресс доставка в любую точку России;
- Техническая поддержка проекта, помощь в подборе аналогов, поставка прототипов;
- Система менеджмента качества сертифицирована по Международному стандарту ISO 9001;
- Лицензия ФСБ на осуществление работ с использованием сведений, составляющих государственную тайну;
- Поставка специализированных компонентов (Xilinx, Altera, Analog Devices, Intersil, Interpoint, Microsemi, Aeroflex, Peregrine, Syfer, Eurofarad, Texas Instrument, Miteq, Cobham, E2V, MA-COM, Hittite, Mini-Circuits, General Dynamics и др.);

Помимо этого, одним из направлений компании «ЭлектроПласт» является направление «Источники питания». Мы предлагаем Вам помощь Конструкторского отдела:

- Подбор оптимального решения, техническое обоснование при выборе компонента;
- Подбор аналогов;
- Консультации по применению компонента;
- Поставка образцов и прототипов;
- Техническая поддержка проекта;
- Защита от снятия компонента с производства.



Как с нами связаться

Телефон: 8 (812) 309 58 32 (многоканальный)

Факс: 8 (812) 320-02-42

Электронная почта: org@eplast1.ru

Адрес: 198099, г. Санкт-Петербург, ул. Калинина, дом 2, корпус 4, литера А.