

Features

- High Power Handling
- Low Loss / Low Distortion
- Low Thermal Resistance
- Leadless Low Inductance MELF Package
- Available as a Chip
- Surface Mountable
- RoHs Compliant
- MSL 1

Description

M/A-Com's MELF packaged PIN diode line encompasses a comprehensive range of electrical characteristics. The particular die in the MA4P504-1072T utilizes M/A-Com's unique CERMACHIP passivation process which provides for a hard glass encapsulation that hermetically seals the active area of the chip. This packaged CERMACHIP PIN diode is ideally suited for use in high power applications where high RF voltages are present.

The chip is enclosed in a rugged ceramic Metal Electrode Leadless Faced (MELF) surface mount package and is full face bonded to refractory metal pins on both the anode and cathode. The result is a low loss PIN diode with low thermal resistance due to symmetrical thermal paths. This rectangular PIN diode is designed for high volume tape and reel assembly. This user friendly package design provides for extremely easy automatic pick and place, indexing and assembly. All solderable surfaces are tin plated and compatible with industry standard reflow and vapor phase soldering processes.

Applications

The MA4P504-1072T MELF packaged PIN diode is suitable for usage in high incident power series, shunt, or series-shunt switches as well as attenuator applications from HF through UHF frequencies.

Ordering Information

Part Number	Package
Ma4P504-1072T	Tape and Reel

Package Style (ODS 1072) Outline Drawing

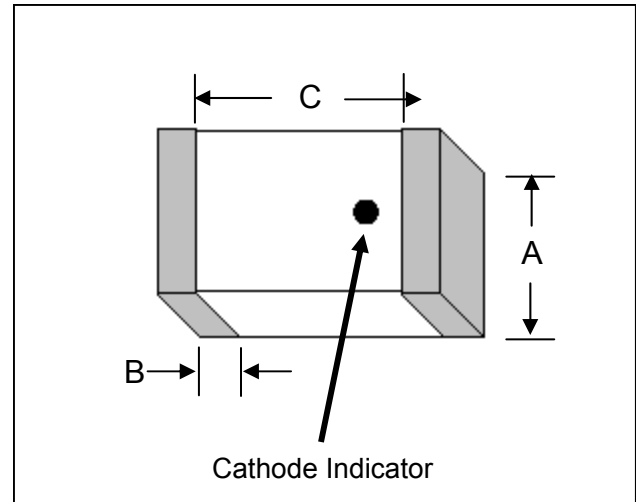

Dimensions	Package Style 1072	
	in	mm
A	0.093	2.36
B	0.050	1.27
C	0.060	1.52

Absolute Maximum Ratings^{1,2} @ 25°C

Parameter	Absolute Maximum
Forward Voltage	1.0 V
Reverse Voltage	500V
Operating Temperature	-65°C to +175°C
Storage Temperature	-65°C to +200°C
Mounting Temperature	+260°C for 30 seconds

1. Exceeding these limits may cause permanent damage to the device.
2. Values will derate over temperature.

Electrical Specifications @ $T_A = +25^\circ\text{C}$

Parameters	Symbols	Conditions	Units	Min.	Typ.	Max.
Total Capacitance	C_{T100V}	-100 V @ 1 MHz	pF	—	—	0.50
Package Capacitance ¹	C_p	—	pF		0.16	
Series Resistance	R_S	+100 mA @ 100 MHz	Ω	—	—	0.60
Minority Carrier Lifetime	T_L	$I_F = 10 \text{ mA}$ $I_R = -6 \text{ mA}$	μS	—	1.0	—
Forward Voltage	V_F	+ 50 mA	V	—	—	1.0
Reverse Leakage Current	$-I_R$	-500 V	μA	—	—	- 10
Thermal Resistance	θ	—	$^\circ\text{C} / \text{W}$	—	15	—
Power Dissipation	P_d	—	W	—	—	10
3rd Order Input Intermodulation Distortion	IIP3	+10dBm Input Power 1000 MHz 1 MHz Spacing	dBm	—	>54	—

1. Package capacitance is for the MELF-1072 package style. Total capacitance $C_t = \text{Junction Capacitance } C_j + \text{Package Capacitance } C_p$

Typical DC Performance Curves

Series Resistance vs. Forward Current

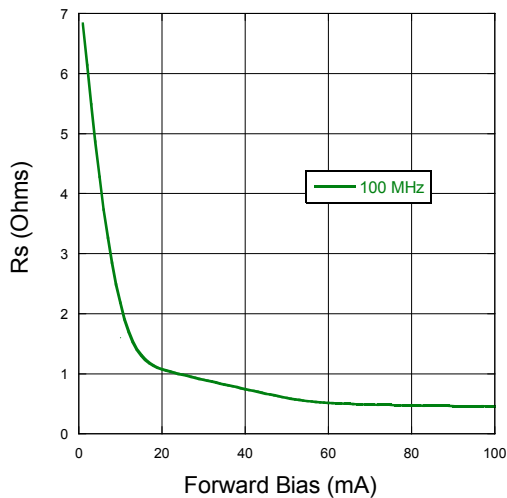

Capacitance vs. Reverse Voltage

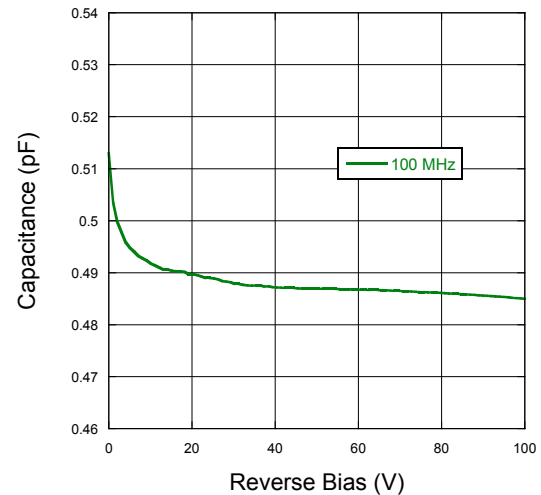

APPLICATIONS SECTION

Typical RF Performance Curves (50 – 4000 MHz)

SERIES DIODE

Input Return Loss

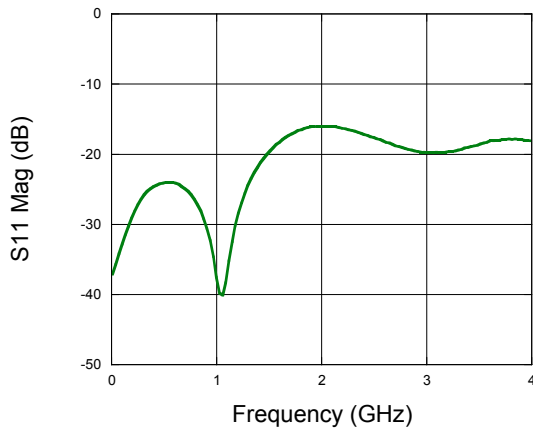

Output Return Loss

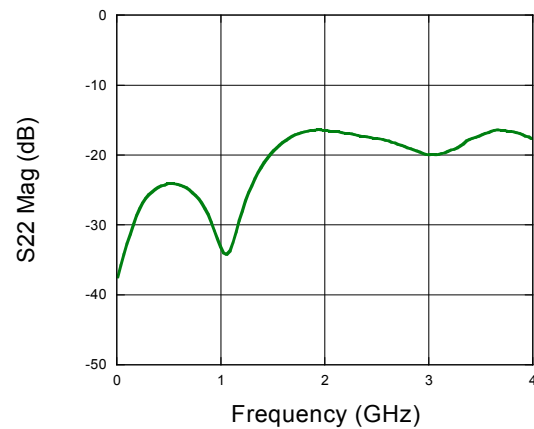

Insertion Loss

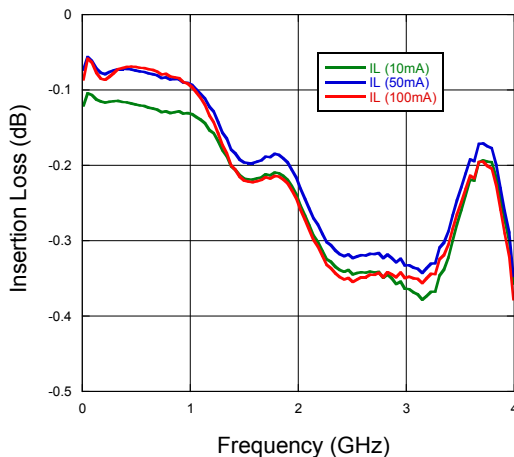

Isolation

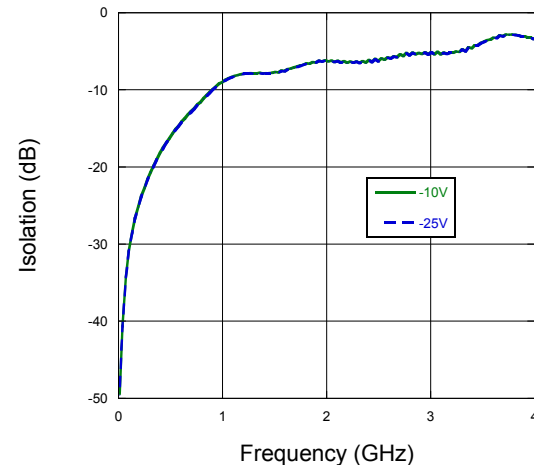

APPLICATIONS SECTION

Typical RF Performance Curves (50 – 4000 MHz)

SHUNT DIODE

Input Return Loss

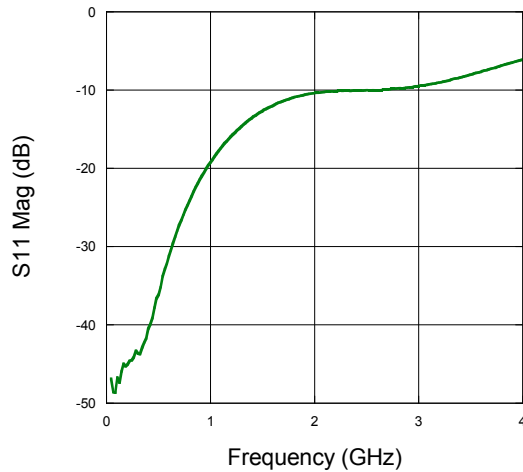

Output Return Loss

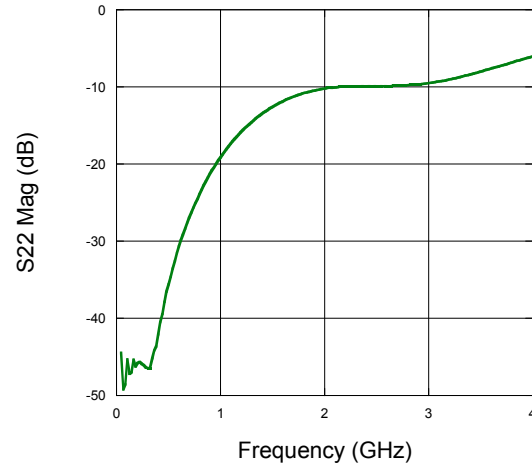

Insertion Loss

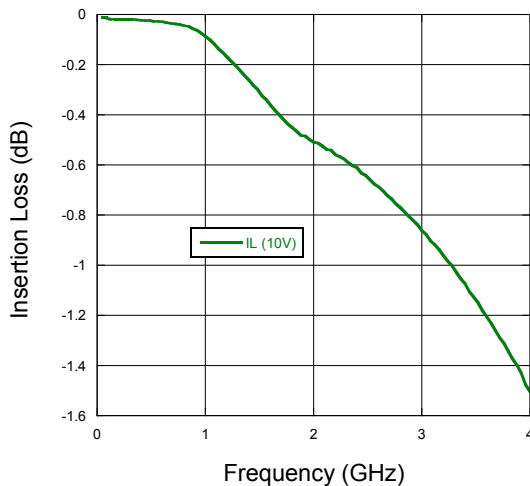

Isolation

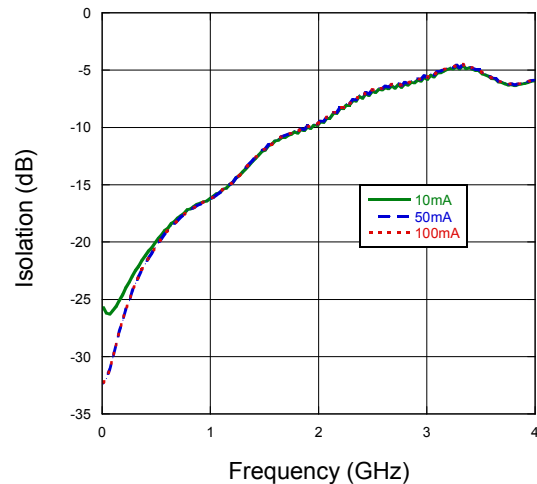

Assembly Recommendations

- Devices may be soldered using standard 63/37, Sn/Pb or RoHS compliant solders. Leads are tin plated 50µM thick to ensure an optimum connection.
- For recommended Sn/Pb and RoHS soldering profile See Application Note [M538](#) on the M/A-COM website.

Handling Procedures

The following precautions should be observed to avoid damaging these devices.

Cleanliness and Storage

These devices should be handled and stored in a clean environment. Ends of the device are tin plated for greater solderability. Continuous exposure to high humidity (>80%) for extended periods may cause the surface to oxidize. Caution should be taken when storing devices for long periods.

ESD

These devices are susceptible to ESD and are rated Class 1C.

General Handling

Device can be handled with tweezers or vacuum pickups and are suitable for use with automatic pick-and-place equipment.

Note: To compare other MELF packaged diodes to the MA4P504-1072, please click on the link to an older version datasheet: [PACKAGED PIN DIODES](#)

RoHS

The MA4P504-1072 is fully RoHS compliant meaning it contains less than the maximum allowable concentration of 0.1% by weight in homogenous materials for lead, hex chrome, mercury, PBB, PBDE, and 0.01% for cadmium.

Mounting Techniques

Solder Attach

Typical wave soldering or reflow techniques may be used to mount M/A-COM's SMQ packages to circuit boards using Sn63/Pb37 alloy or RoHS compliant solders. For more information visit the M/A-COM website and read application note [M538](#).

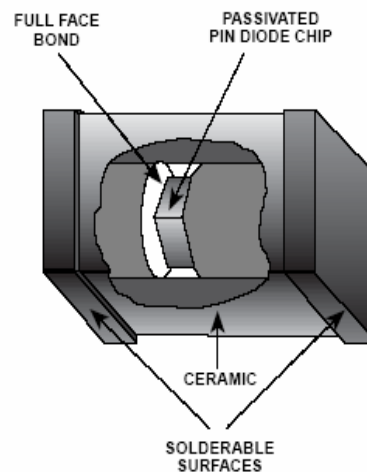



Компания «ЭлектроПласт» предлагает заключение долгосрочных отношений при поставках импортных электронных компонентов на взаимовыгодных условиях!

Наши преимущества:

- Оперативные поставки широкого спектра электронных компонентов отечественного и импортного производства напрямую от производителей и с крупнейших мировых складов;
- Поставка более 17-ти миллионов наименований электронных компонентов;
- Поставка сложных, дефицитных, либо снятых с производства позиций;
- Оперативные сроки поставки под заказ (от 5 рабочих дней);
- Экспресс доставка в любую точку России;
- Техническая поддержка проекта, помощь в подборе аналогов, поставка прототипов;
- Система менеджмента качества сертифицирована по Международному стандарту ISO 9001;
- Лицензия ФСБ на осуществление работ с использованием сведений, составляющих государственную тайну;
- Поставка специализированных компонентов (Xilinx, Altera, Analog Devices, Intersil, Interpoint, Microsemi, Aeroflex, Peregrine, Syfer, Eurofarad, Texas Instrument, Miteq, Cobham, E2V, MA-COM, Hittite, Mini-Circuits, General Dynamics и др.);

Помимо этого, одним из направлений компании «ЭлектроПласт» является направление «Источники питания». Мы предлагаем Вам помощь Конструкторского отдела:

- Подбор оптимального решения, техническое обоснование при выборе компонента;
- Подбор аналогов;
- Консультации по применению компонента;
- Поставка образцов и прототипов;
- Техническая поддержка проекта;
- Защита от снятия компонента с производства.



Как с нами связаться

Телефон: 8 (812) 309 58 32 (многоканальный)

Факс: 8 (812) 320-02-42

Электронная почта: org@eplast1.ru

Адрес: 198099, г. Санкт-Петербург, ул. Калинина, дом 2, корпус 4, литера А.