



## XLR - SEALED SERIES

NEW PRODUCT BULLETIN 604

# SWITCHCRAFT®

A HEICO COMPANY

Please visit [www.switchcraft.com](http://www.switchcraft.com) for the most up-to-date product specifications.

# XLR - SEALED SERIES

NEW PRODUCT BULLETIN 604



**Cord**

**In-Line**

**Panel**

## FEATURES & BENEFITS

- Panel connector sealed to IP68  
NEMA 250 (6P) unmated
- Mated pairs sealed to IP66
- Cable, panel & cable to cable options
- Silver or Gold plated contacts
- RoHS Compliant

## APPLICATIONS

- Outdoor communications equipment
- Audio Applications
- Instrumentation
- Stage Lighting

# XLR - SEALED SERIES

NEW PRODUCT BULLETIN 604

## SEALED AAA SERIES XLR CORD CONNECTORS-FEMALE ONLY



CONTACTS AS VIEWED FACING CORD CONNECTORS

## SEALED AAA SERIES XLR IN-LINE CONNECTORS-MALE ONLY



CONTACTS AS VIEWED FACING IN-LINE CONNECTORS

ALL DIMENSIONS ARE REFERENCE ONLY

# XLR - SEALED SERIES

NEW PRODUCT BULLETIN 604

## SEALED AAA SERIES XLR PANEL-MOUNT CONNECTORS - MALE ONLY

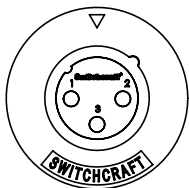
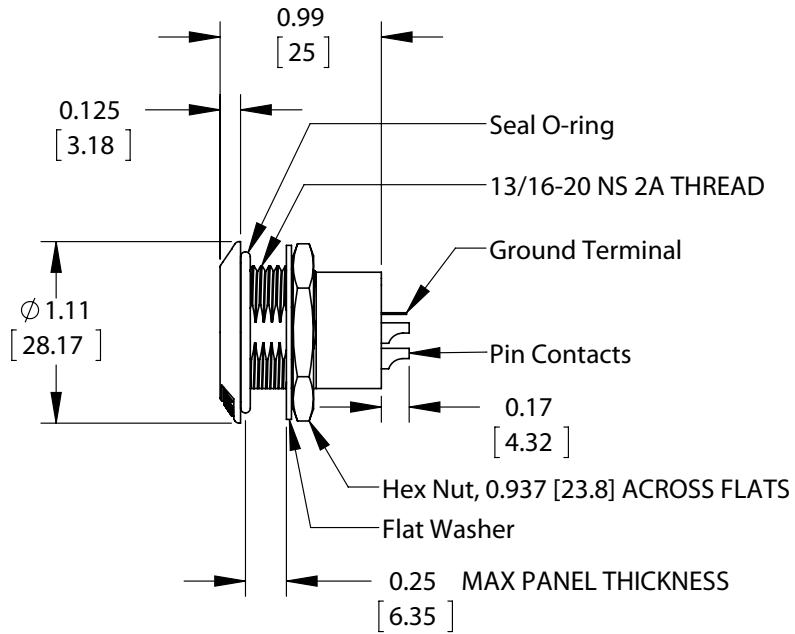

3 PIN

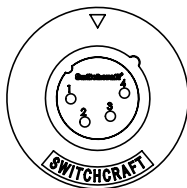

4 PIN

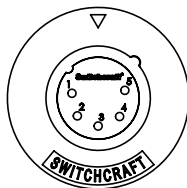

5 PIN

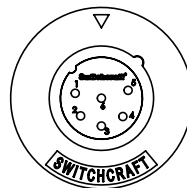

6 PIN

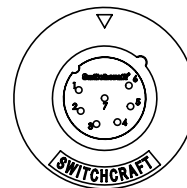

7 PIN

CONTACTS AS VIEWED FACING PANEL-MOUNT CONNECTORS

ALL DIMENSIONS ARE REFERENCE ONLY

Please visit [www.switchcraft.com](http://www.switchcraft.com) for the most up-to-date product specifications.

# XLR - SEALED SERIES

## NEW PRODUCT BULLETIN 604

### SPECIFICATIONS

#### MECHANICAL SPECIFICATIONS

Life:	1000 minimum insertion / withdrawal cycles
Wire Sizes:	14-26 AWG
Operating Forces:	Insertion: 8lb. nominal, 10lb. maximum Withdrawal: 5lb. nominal, 7lb. maximum

#### ELECTRICAL SPECIFICATIONS

Voltage Rating:	500 VRMS
Current Rating:	15A with 14 AWG wiring 12A with 16 AWG wiring 10A with 18 AWG wiring 8A with 20 AWG wiring 6A with 22 AWG wiring 4A with 24 AWG wiring 3A with 26 AWG wiring
Insulation Resistance:	1000 M $\Omega$ minimum, initial
Contact Resistance:	50 m $\Omega$ maximum
Dielectric Withstanding Voltage:	1000 V (rms)
Capacitance:	$\leq$ 3 pF between contacts $\leq$ 6 pF between contacts and shell

#### ENVIRONMENTAL SPECIFICATIONS

Operating Temperature Rating:	-40°C to +65°C (-40°F to +149°F)
Moisture Resistance:	Mil-Std 202G Method 106G
Insulation Resistance:	Mil-Std 202G Method 302 condition B
Thermal Shock:	Mil-Std 202G Method 107G
Salt Atmosphere (Corrosion):	Mil-Std 202G Method 101E condition B
Weathertight Ratings:	Panel, Cord & In-Line Connectors: IP66 when mated Panel-Mount Connectors: IP68, NEMA 250(6P) unmated

#### MATERIAL SPECIFICATIONS

Shell:	Die-cast Zinc Alloy, Nickel or Black finish
Insulator Insert:	Thermoplastic, Green
Contacts, Pins or Sockets:	Copper Alloy, Silver or Gold plated
Ground Spring Terminal:	Copper Alloy, Tin plated
Latch:	Die-cast Zinc Alloy, Nickel plated
Handle:	Die-cast Zinc Alloy, Nickel plated or Black Finish Black Thermoplastic option available
Cable Clamp:	Thermoplastic, Black
Seal Boot, Ring, Cable Strain Relief:	Elastomer

# XLR - SEALED SERIES

NEW PRODUCT BULLETIN 604

## ORDERING CODE: CORD AND IN-LINE CONNECTORS

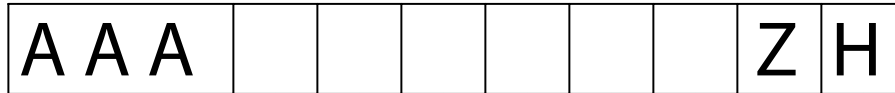

AAA Series

# OF CONTACTS:  
3 - 7

GENDER:  
F - Female (Cord Only)  
M - Male (In-Line Only)

HANDLE STYLE:  
Leave blank for Metal Handle  
P - Plastic handle

FINISH:  
Leave blank for Nickel  
B - Black

Harsh Environment  
(Sealed)

CABLE STRAIN-RELIEF SIZE:  
Leave blank for Cable O.D. range  
0.150" - 0.285" [3.8 mm - 7.2 mm]

CONTACT PLATING:  
Leave blank for Silver  
AU - Gold

## ORDERING CODE: PANEL-MOUNT CONNECTORS



B Series

# OF CONTACTS:  
3 - 7

GENDER:  
M - Male

Harsh Environment  
(Sealed)

CONTACT PLATING:  
Leave blank for Silver  
AU - Gold

FINISH:  
Leave blank for Nickel  
B - Black



Компания «ЭлектроПласт» предлагает заключение долгосрочных отношений при поставках импортных электронных компонентов на взаимовыгодных условиях!

Наши преимущества:

- Оперативные поставки широкого спектра электронных компонентов отечественного и импортного производства напрямую от производителей и с крупнейших мировых складов;
- Поставка более 17-ти миллионов наименований электронных компонентов;
- Поставка сложных, дефицитных, либо снятых с производства позиций;
- Оперативные сроки поставки под заказ (от 5 рабочих дней);
- Экспресс доставка в любую точку России;
- Техническая поддержка проекта, помощь в подборе аналогов, поставка прототипов;
- Система менеджмента качества сертифицирована по Международному стандарту ISO 9001;
- Лицензия ФСБ на осуществление работ с использованием сведений, составляющих государственную тайну;
- Поставка специализированных компонентов (Xilinx, Altera, Analog Devices, Intersil, Interpoint, Microsemi, Aeroflex, Peregrine, Syfer, Eurofarad, Texas Instrument, Miteq, Cobham, E2V, MA-COM, Hittite, Mini-Circuits, General Dynamics и др.);

Помимо этого, одним из направлений компании «ЭлектроПласт» является направление «Источники питания». Мы предлагаем Вам помощь Конструкторского отдела:

- Подбор оптимального решения, техническое обоснование при выборе компонента;
- Подбор аналогов;
- Консультации по применению компонента;
- Поставка образцов и прототипов;
- Техническая поддержка проекта;
- Защита от снятия компонента с производства.



#### Как с нами связаться

**Телефон:** 8 (812) 309 58 32 (многоканальный)

**Факс:** 8 (812) 320-02-42

**Электронная почта:** [org@eplast1.ru](mailto:org@eplast1.ru)

**Адрес:** 198099, г. Санкт-Петербург, ул. Калинина, дом 2, корпус 4, литера А.