

Description

The AVO100B-48S1V5 DC-DC converter is a next-generation industry standard eighth-brick with optimized ultra-high efficiency. This module can provide up to 40A output current at 1.5V output voltage, industry standard eighth-brick 57.9mm × 22.9mm × 9.6mm (2.28" × 0.9" × 0.378"), which makes it an ideal choice for small space, telecom and datacom applications. The AVO100B-48S1V5 is standard eighth-brick pin-out configuration, with baseplate option. It provides CNT remote control, trim and sense functions, with OVP, OCP, OTP full protection method. This product can achieve ultra-high efficiency of 90.7% at 60% load. A heatsink can be installed for better thermal performance.

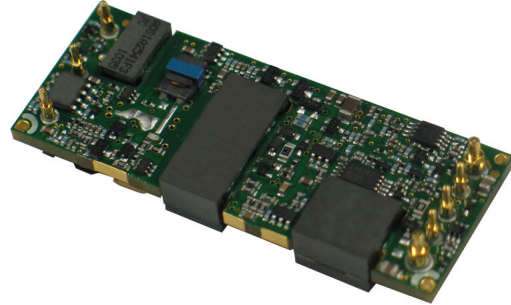

Operational Features

- Up to 40A output current
- Ultra-high efficiency 90.7% typ. at 60% load
- Wide input range: 36V ~ 75V
- Excellent thermal performance
- No minimum load requirement
- Intended for reflow or wave soldering
- RoHS 6 compliant

Control Features

- Remote control function
- Remote output sense
- Trim function: 80% ~ 110%
- .

Protection Features

- Input under-voltage lockout
- Output over-current protection
- Output over-voltage protection
- Over-temperature protection

Mechanical Features

- Industry standard eighth-brick
- With baseplate option
- Pin length option: 3.8mm

Safety & EMC

- Meets safety standards UL 60950-1 2nd edition, IEC/EN 60950-1 2nd edition and GB4943
- Approved by UL and TUV
- Meets the Low Voltage Directives 2006/95/EEC with the Amendment Directive 93/68/EEC which facilitates CE marking in user's end product
- Materials meet UL94,V-0 flammability rating
- Meets conducted emission's requirements of FCC Class A and EN55022 Class A with external filter

Electrical Characteristics

Full operating ambient temperature range is -40°C to +85°C.

Specifications are subject to change without notice. Test condition: Ta: 25°C. Air velocity: 300LFM.

Parameter		Min.	Typ.	Max.	Unit	Notes & conditions
Absolute max. ratings						
Input voltage	Non-operating	-	-	100	V	100ms
	Operating	-	-	80	V	Continuous
Operating temperature		-40	-	+85	°C	-
Storage temperature		-55	-	+125	°C	-
Voltage at remote ON/OFF pin		-0.7	-	12	V	-
Input characteristics						
Operating input voltage range		36	48	75	V	-
Input under-voltage lockout	Turn-on voltage threshold	31	-	36	V	-
	Turn-off voltage threshold	30	-	35	V	-
	Lockout voltage hysteresis	1	-	3	V	-
Max. input current		-	-	3.5	A	36Vin, full load
No-load input current		-	0.05	-	A	
Standby input current		-	0.005	0.015	A	Remote OFF
Inrush current transient rating		-	-	1	A2s	Figure 15
Input reflected ripple current		-	-	40	mA	Through 12µH inductor; Figure 15
Recommended input fuse		-	-	10	A	External fast blow fuse is recommended; Figure 11
Recommended external input capacitance		100	-	-	µF	Low ESR capacitor is recommended; Figure 11
Output characteristics						
Output voltage set point (standard option)		1.48	1.5	1.52	V	48Vin, half load
Output voltage line regulation		-	±0.1	±0.2	%	-
		-	-	-	mV	-
Output voltage load regulation		-	±0.1	±0.5	%	-
		-	-	-	mV	-
Output voltage temperature regulation		-	-	0.02	%/°C	-

Parameter		Min.	Typ.	Max.	Unit	Notes & conditions
Total output voltage range		1.45	1.5	1.55	V	Over sample, line, load, temperature & life
Output voltage ripple and noise		-	55		mVpp	Figure 2 20MHz bandwidth; Figure 15
Output voltage ripple and noise		-	50	-	mVpp	Ta: 25°C, Air velocity: 300LFM, Vin: 48V, Vonom, Ionom, 10u tantalum (ESR ≤ 100mΩ)//1u ceramic capacitor, output ≤ 12V
Operating output current range		0	-	40	A	-
Output DC current-limit inception		42	-	57	A	Hiccup: auto-restart when over-current condition is removed
Output capacitance		330	-	40000	μF	High frequency and low ESR are recommended
Dynamic characteristics						
Dynamic response	25% ~ 50% ~ 25% Io,max, 0.1A/μs	-	40	-	mV	Figure 4 Test condition: 25°C, nominal input voltage, Figure 10
	Settling time	-	150	-	μs	Recovery to within 1% Vo,nom
	25% ~ 50% ~ 25% Io,max, 1A/μs	-	100	-	mV	Figure 5 Test condition: 25°C, nominal input voltage, Figure 11
	Settling time	-	200	-	μs	Recovery to within 1% Vo,nom
Turn-on transient	Rise time	-	5	50	ms	Full load, Figure 6
	Turn-on delay time	-	62	200	ms	-
	Output voltage overshoot	-	0	-	%Vo	-
Efficiency						
100% load		-	89	-	%	Figure 1
60% load		-	90.7	-	%	Figure 1
20% load		-	87.5	-	%	Figure 1

Electrical Characteristics (Continued)

Parameter		Min.	Typ.	Max.	Unit	Notes & conditions
Isolation characteristics						
Isolation voltage (conditions: 1mA for 60s, slew rate of 2000V/10s)		2250	-	-	V	Basic insulation, pollution degree 2, input to output
Feature characteristics						
Switching frequency		-	165	-	KHz	-
Remote ON/OFF control (positive logic)	Off-state voltage	-0.7	-	1.2	V	Figure 12
	On-state voltage	3.5	-	12	V	
Remote ON/OFF control (negative logic)	Off-state voltage	3.5	-	12	V	
	On-state voltage	-0.7	-	1.2	V	
Output voltage trim range		1.2	-	1.65	V	See <i>Trim Characteristics of Application Note</i>
Output voltage remote sense range		-	-	0.12	V	-
Output over-voltage protection (dynamic)		1.75	-	2.6	V	Hiccup: auto-restart when over-voltage condition is removed
Over-temperature shutdown		-	120	-	°C	Auto recovery; over-temperature protection (OTP) test point: Figure 10. Tested under thermal balance condition
Over-temperature hysteresis		-	5	-	°C	-
Reliability characteristics						
Calculated MTBF (telcordia)		-	1.5	-	106h	Telcordia SR-332-2006; 80% load, 300LFM, 40°C Ta

Electromagnetic Compatibility Characteristics

Test item	Regulations	Criteria	Notes & conditions
Conducted emission	EN 55022 DC input port, class A limits	/	See EMC Test Conditions
Immunity to electrostatic discharge	IEC/EN61000-4-2 Enclosure port, level 3	B	
Immunity to electrical fast transient	IEC/EN61000-4-4 DC input port, level 3	B	
Immunity to surges	IEC/EN61000-4-5 DC input port Line to ground (earth): 600V Line to line: 600V	B	
Immunity to continuous conducted interference	IEC/EN61000-4-6 DC input port, level 2	A	
Immunity to voltage dips and short interruptions and voltage variations	EN 61000-4-29 DC input port	B	

Criterion A: Normal performance during and after test.

Criterion B: For EFT and surges, low-voltage protection or reset is not allowed. Temporary output voltage fluctuation ceases after disturbances ceases, and from which the EUT recovers its normal performance automatically. For dips and ESD, output voltage fluctuation or reset is allowed during the test, but recovers to its normal performance automatically after the disturbance ceases.

Qualification Testing

Parameter	Unit (pcs)	Test condition
Halt test	4 ~ 5	Ta, min-10°C to Ta, max+10°C, 5°C step, Vin = min to max, 0 ~ 105% load
Vibration	3	Frequency range: 5Hz ~ 20Hz, 20Hz ~ 200Hz, A.S.D: 1.0m2/s3, -3db/oct, axes of vibration: X/Y/Z. Time: 30 min/axis
Mechanical shock	3	30g, 6ms, 3 axes, 6 directions, 3 time/direction
Thermal shock	3	-40°C to +100°C, unit temperature 20 cycles
Thermal cycling	3	-40°C to +55°C, temperature change rate: 1°C/min, cycles: 2 cycles
Humidity	3	40°C, 95%RH, 48h
Solder ability	15	IPC J-STD-002C-2007

Characteristic Curves

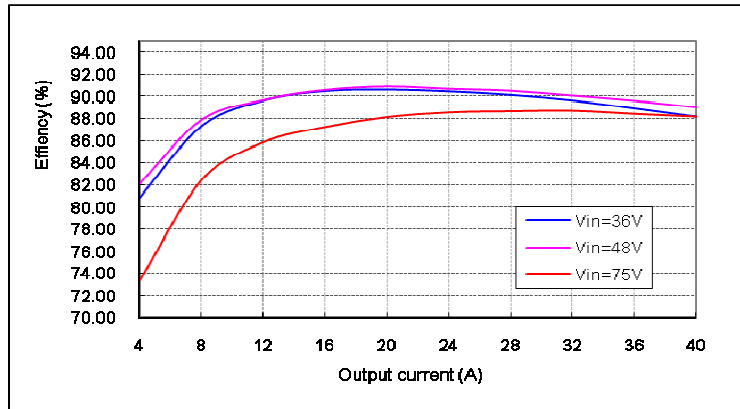

Figure 1 Efficiency vs. output current, Ta = 25°C, Vo = 1.5V, Air velocity = 300LFM

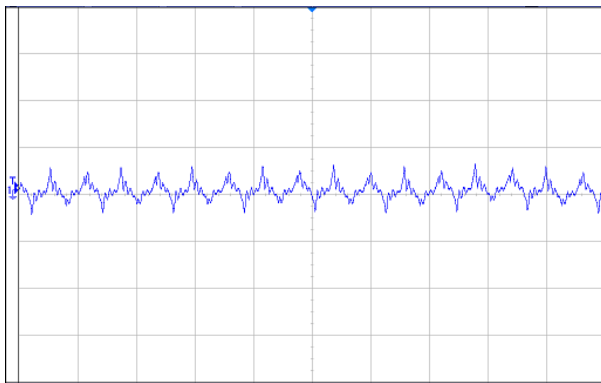

Figure 2 Output ripple & noise (5µs/div, 50mV/div), see Figure 15 for test configuration

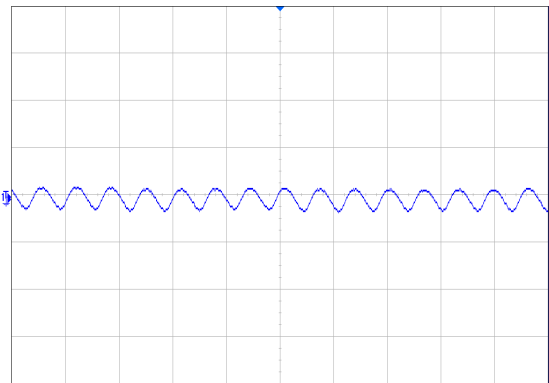

Figure 3 Input reflected ripple current (5µs/div, 10mA/div), see Figure 15 for test configuration

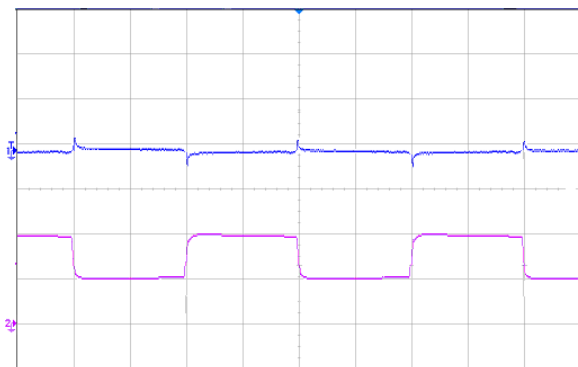

Figure 4 Dynamic response for 25% load step (25% ~ 50% ~ 25%) and 0.1A/µs slew rate, (2ms/div), see Figure 11 for test configuration; CH1-output voltage (100mV/div); CH2-output current (10A/div)

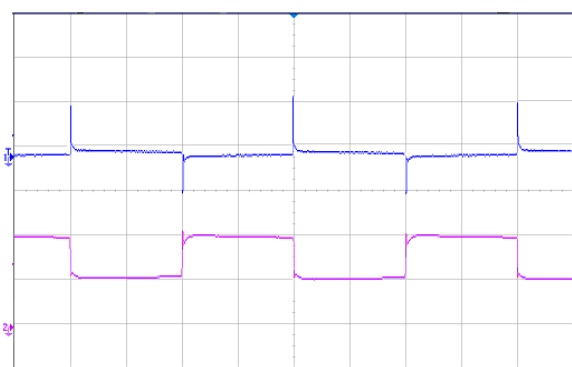

Figure 5 Dynamic response for 25% load step (25% ~ 50% ~ 25%) and 1A/µs slew rate, (2ms/div), see Figure 11 for test configuration; CH1-output voltage (100mV/div); CH2-output current (10A/div)

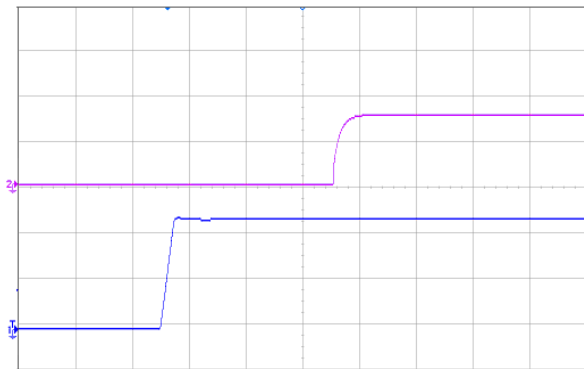

Figure 6 Output voltage startup by power-on, (50ms/div), see Figure 11 for test configuration; CH1-input voltage (20V/div); CH2-output voltage (1V/div)

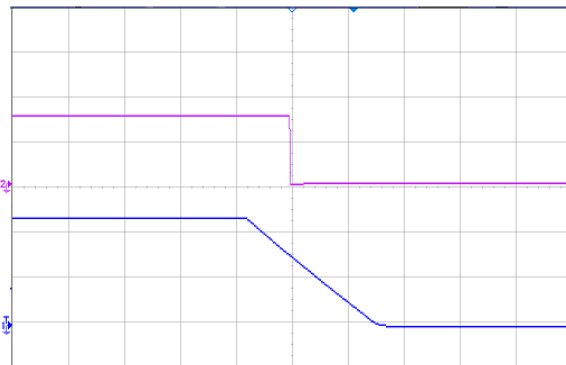

Figure 7 Output voltage shutdown by power-off, (100ms/div), see Figure 11 for test configuration; CH1-input voltage (20V/div); CH2-output voltage (1V/div)

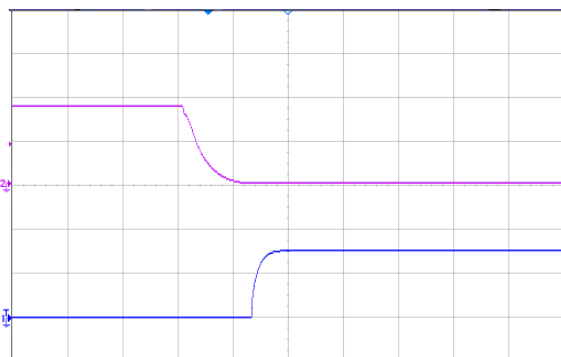

Figure 8 Output voltage startup by remote ON, (20ms/div), see Figure 11 for test configuration; CH1-output voltage (1V/div); CH2-remote ON voltage (2V/div) (Negative logic)

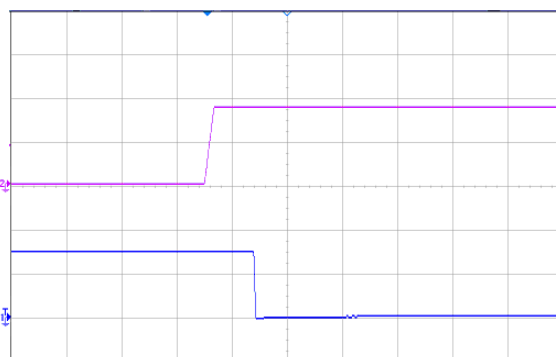

Figure 9 Output voltage shutdown by remote OFF, (20ms/div), see Figure 11 for test configuration; CH1-output voltage (1V/div); CH2-remote OFF voltage (2V/div) (Negative logic)

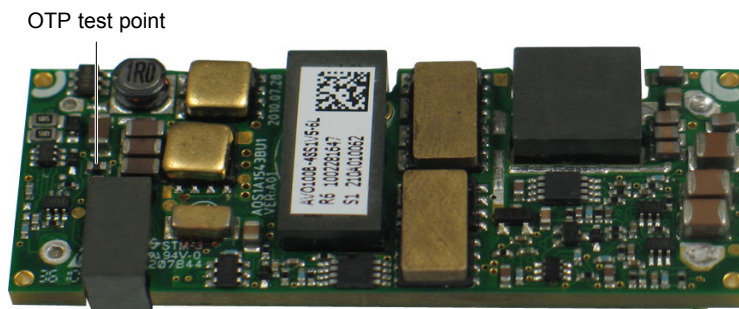

Figure 10 OTP test point

Application Note

Typical Application

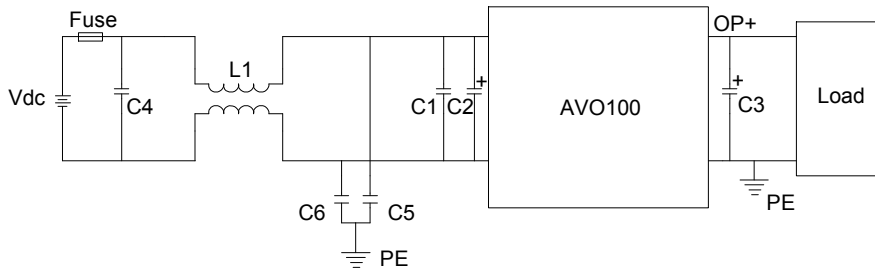

Figure 11 Typical application

Recommended input fuse: LITTLEFUSE 216010.P 10A

C1: SMD eramic-100V-100nF-±10%-X7R-1206

C2: 100µF/100V electrolytic capacitor, high frequency and low ESR

C3:1000µF/10V electrolytic capacitor, high frequency and low ESR

C4: SMD ceramic-100V-1000nF-X7R-1210

C5, C6: SMD ceramic-47nF/1000V/X7R-1210

L1: 1320uH-±25%-4A-R5K-21mm × 21mm × 12.5mm

Remote ON/OFF

Either positive or negative remote ON/OFF logic is available in AVO100B-48S1V5. The logic is CMOS and TTL compatible.

The voltage between pin Remote ON/OFF and pin Vin- must not exceed the range listed in *Feature Characteristics* to ensure proper operation. The external remote ON/OFF circuit in AVO100B-48S1V5 is highly recommended as shown in Figure 12.

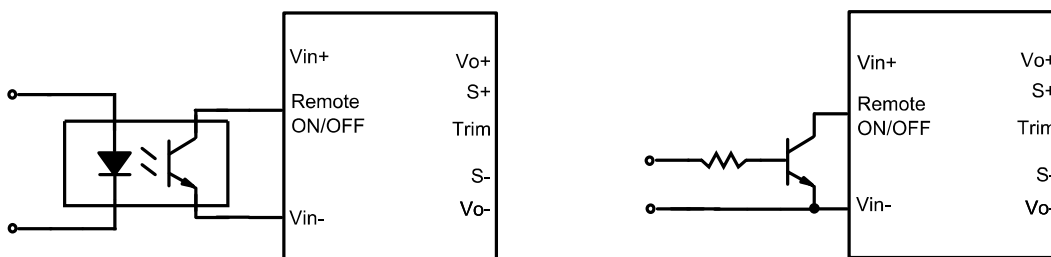

Isolated remote ON/OFF circuit

non-isolated remote ON/OFF circuit

Figure 12 External remote ON/OFF circuit

Trim Characteristics

Connecting an external resistor between Trim pin and Vo- pin will decrease the output voltage, while connecting it between Trim and Vo+ will increase the output voltage. The following equations determine the external resistance to obtain the trimmed output voltage.

$$R_{adj_down} = \left(\frac{511}{\Delta\%} - 10.22 \right) k\Omega$$

$$R_{adj_up} = \left(\frac{5.11 V_{out} (100 + \Delta\%)}{V_{ref} \Delta\%} - \frac{511}{\Delta\%} - 10.22 \right) k\Omega$$

R_{adj_down} : Value of the external adjustment resistor which shall be connected between Trim and S- for trimming down.

$\Delta\%$: Output voltage change rate against nominal output voltage.

R_{adj_up} : Value of the external adjustment resistor which shall be connected between Trim and S+ for trimming up.

V_{out} : Nominal output voltage.

$V_{ref} = 1.225V$

When trimming up, the output current should be decreased accordingly so as not to exceed the maximum output power as shown in below figure.

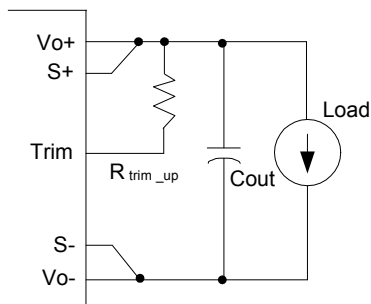

Figure 13 Trim up

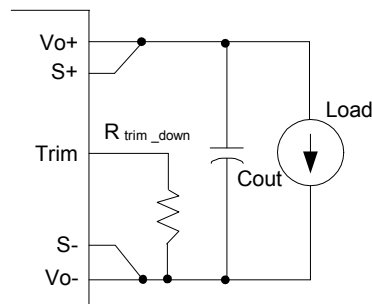

Figure 14 Trim down

Sense Characteristics

If the load is far from the unit, connect S+ and S- to the terminals of the load respectively to compensate the voltage drop on the transmission line.

If the sense compensate function is not necessary, connect S+ to Vo+ and S- to Vo- directly.

Input Ripple & Inrush Current And Output Ripple & Noise Test Configuration

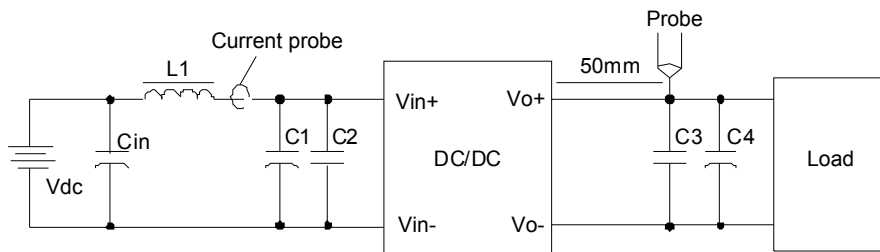

Figure 15 Input ripple & inrush current, output ripple & noise test configuration

Vdc: DC power supply

L1: 12μH

Cin: 220μF/100V typical

C1: SMD ceramic-100V-100nF-±10%-X7R-1206

C2: 100μF/100V electrolytic capacitor, high frequency and low ESR

C3: SMD ceramic-10V-1μF-±10%-X7R-1206

C4: 1000μF/10V electrolytic capacitor, high frequency and low ESR

Note: It is recommended to use a coaxial cable with series 50Ω resistor and 0.68μF ceramic capacitor or a ground ring of probe to test output ripple & noise.

EMC Test Conditions

See Figure11.

Thermal Considerations

The converter is designed to operate in different thermal environments and sufficient cooling must be provided. Proper cooling of the DC-DC converter can be verified by measuring the temperature at the test points as shown in Figure 16 and Figure 17. The temperature at these points should not exceed the maximum values in Table 1 when the module is operating.

For a typical application, forced airflow direction is from Vin- to Vin+. Figure 18 shows the derating of output current vs. ambient air temperature at different air velocity.

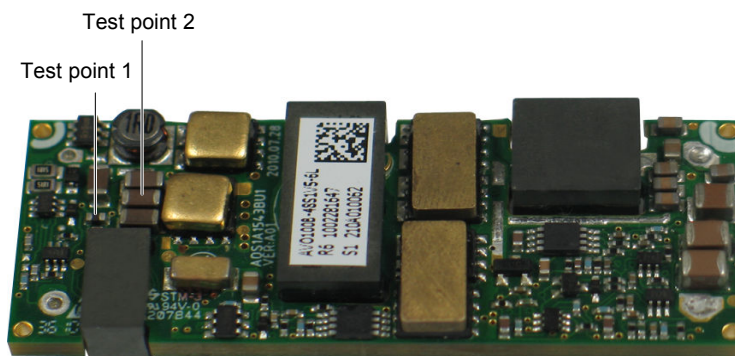

Figure 16 Thermal test point (top)

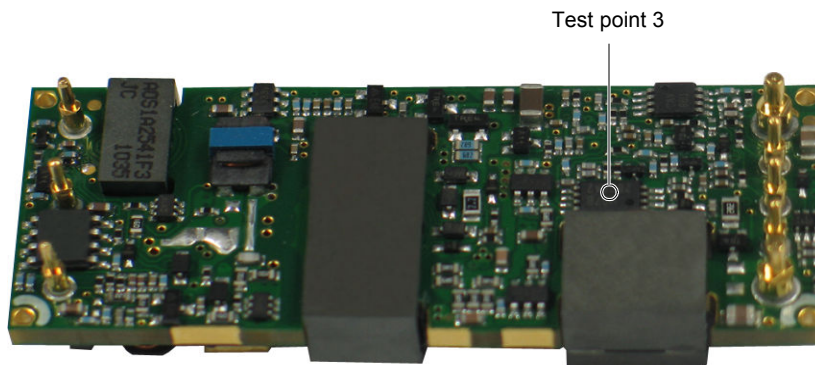

Figure 17 Thermal test point (bottom)

Table 1 Temperature limit of the test points

Test point	Temperature limit
Test point 1	114°C
Test point 2	118°C
Test point 3	115°C

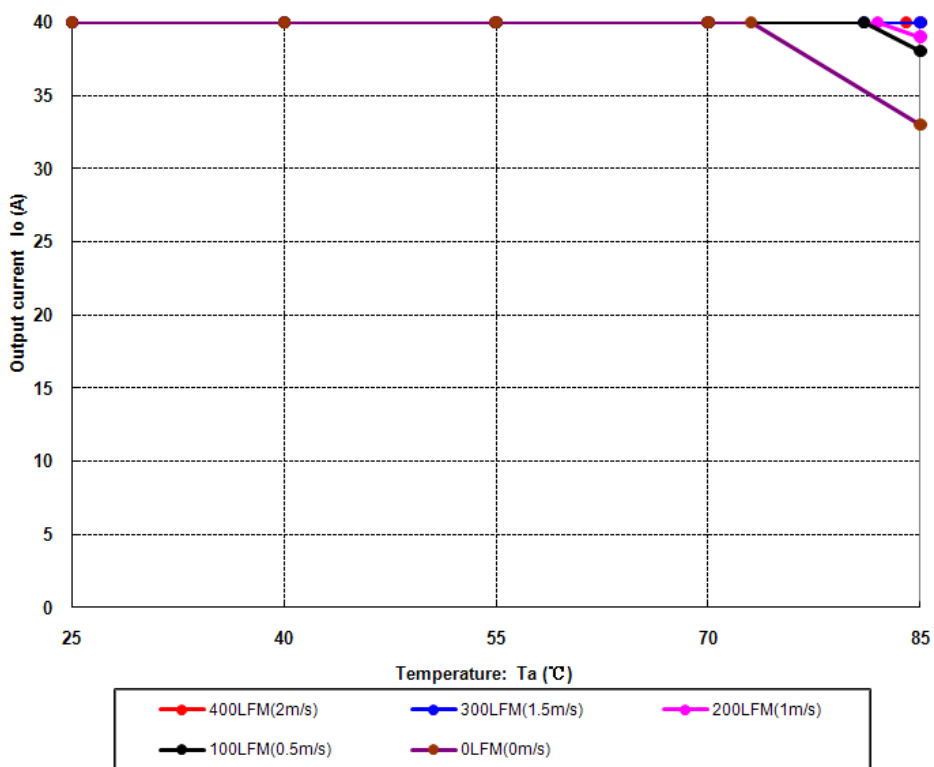
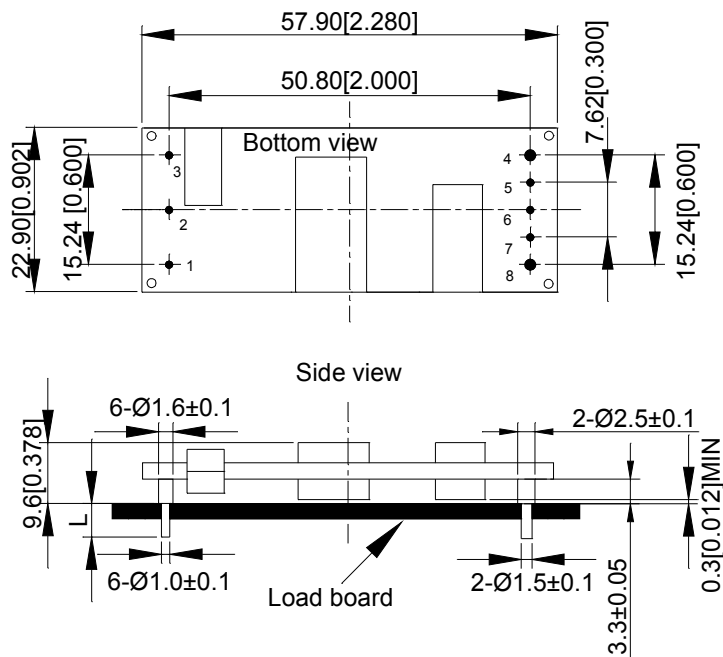

Figure 18 Output power derating, 48Vin, air flowing across the converter from Vin- and Vin+

Mechanical Diagram



Unit: mm[inch] Bottom view: pin on upside

Tolerance: X.Xmm±0.5mm[X.X in.±0.02in.]
 X.XXmm±0.25mm[X.XX in.±0.01in.]

Figure 19 Mechanical diagram

Pin Length Option

Device code suffix	L
-4	4.8mm ± 0.25mm
-6	3.8mm ± 0.25mm
-8	2.8mm ± 0.25mm
None	5.8mm ± 0.25mm

Pin Designations

Pin No.	Name	Function
1	Vin+	Positive input voltage
2	Remote ON/OFF	Remote control
3	Vin-	Negative input voltage
4	Vo-	Negative output voltage
5	S-	Negative remote sense
6	Trim	Output voltage trim
7	S+	Positive remote sense
8	Vo+	Positive output voltage

Soldering

For R6 product, it is intended for standard manual, reflow or wave soldering.

When reflow soldering is used, the temperature on pins is specified to maximum 260°C for maximum 10s.

When wave soldering is used, the temperature on pins is specified to maximum 260°C for maximum 7s.

When manual soldering is used, the iron temperature should be maintained at 300°C ~ 380°C and applied to the converter pins for less than 10s. Longer exposure can cause internal damage to the converter.

Cleaning of solder joint can be performed with cleaning solvent IPA or simulative.

For R5 product, it is intended for standard manual, reflow or wave soldering.

When reflow soldering is used, the temperature on pins is specified to maximum 230°C for maximum 10s.

When wave soldering is used, the temperature on pins is specified to maximum 255°C for maximum 7s.

When manual soldering is used, the iron temperature should be maintained at 300°C ~ 380°C and applied to the converter pins for less than 10s. Longer exposure can cause internal damage to the converter.

Cleaning of solder joint can be performed with cleaning solvent IPA or simulative.

Ordering Information

AVO100	-	48	S	1V5			-	6	L
①		②	③	④	⑤	⑥		⑦	⑧

①	Model series	AVO: series name, 100: output power 100W
②	Input voltage	48: 36V ~ 75V input range, rated input voltage 48V
③	Output number	S: single output
④	Rated output voltage	1V5: 1.5V output
⑤	Remote ON/OFF logic	Default: negative; P: positive logic
⑥	Baseplate	Default: without baseplate; B: with baseplate
⑦	Pin length	6: 3.8mm
⑧	RoHS status	L: RoHS, R6; Y: RoHS, R5

Model number	Description
AVO100B-48S1V5-6L	3.8mm pin length; negative on/off logic; open frame, R6 compliant
AVO100B-48S1V5P-6L	3.8mm pin length; positive on/off logic; open frame, R6 compliant
AVO100B-48S1V5B-6L	3.8mm pin length; negative on/off logic; with baseplate; R6 compliant, see <i>AVO100B-48S1V5B TRN</i>
AVO100B-48S1V5PB-6L	3.8mm pin length; positive on/off logic; with baseplate; R6 compliant, see <i>AVO100B-48S1V5B TRN</i>
AVO100B-48S1V5-6Y	3.8mm pin length; negative on/off logic; open frame, R5 compliant
AVO100B-48S1V5P-6Y	3.8mm pin length; positive on/off logic; open frame, R5 compliant
AVO100B-48S1V5B-6Y	3.8mm pin length; negative on/off logic; with baseplate; R5 compliant, see <i>AVO100B-48S1V5B TRN</i>
AVO100B-48S1V5PB-6Y	3.8mm pin length; positive on/off logic; with baseplate; R5 compliant, see <i>AVO100B-48S1V5B TRN</i>

Hazardous Substances Announcement (RoHS Of China)

Parts	Hazardous substances					
	Pb	Hg	Cd	Cr ⁶⁺	PBB	PBDE
AVO100 -48S1V5	○	○	○	○	○	○
<p>○: Means the content of the hazardous substances in all the average quality materials of the part is within the limits specified in SJ/T-11363-2006</p> <p>√: Means the content of the hazardous substances in at least one of the average quality materials of the part is outside the limits specified in SJ/T11363-2006</p> <p>Emerson Network Power Co., Ltd. has been committed to the design and manufacturing of environment-friendly products. It will reduce and eventually eliminate the hazardous substances in the products through unremitting efforts in research. However, limited by the current technical level, the following parts still contain hazardous substances due to the lack of reliable substitute or mature solution:</p> <ol style="list-style-type: none"> 1. Solders (including high-temperature solder in parts) contain plumbum. 2. Glass of electric parts contains plumbum. 3. Copper alloy of pins contains plumbum 						



Компания «ЭлектроПласт» предлагает заключение долгосрочных отношений при поставках импортных электронных компонентов на взаимовыгодных условиях!

Наши преимущества:

- Оперативные поставки широкого спектра электронных компонентов отечественного и импортного производства напрямую от производителей и с крупнейших мировых складов;
- Поставка более 17-ти миллионов наименований электронных компонентов;
- Поставка сложных, дефицитных, либо снятых с производства позиций;
- Оперативные сроки поставки под заказ (от 5 рабочих дней);
- Экспресс доставка в любую точку России;
- Техническая поддержка проекта, помощь в подборе аналогов, поставка прототипов;
- Система менеджмента качества сертифицирована по Международному стандарту ISO 9001;
- Лицензия ФСБ на осуществление работ с использованием сведений, составляющих государственную тайну;
- Поставка специализированных компонентов (Xilinx, Altera, Analog Devices, Intersil, Interpoint, Microsemi, Aeroflex, Peregrine, Syfer, Eurofarad, Texas Instrument, Miteq, Cobham, E2V, MA-COM, Hittite, Mini-Circuits, General Dynamics и др.);

Помимо этого, одним из направлений компании «ЭлектроПласт» является направление «Источники питания». Мы предлагаем Вам помощь Конструкторского отдела:

- Подбор оптимального решения, техническое обоснование при выборе компонента;
- Подбор аналогов;
- Консультации по применению компонента;
- Поставка образцов и прототипов;
- Техническая поддержка проекта;
- Защита от снятия компонента с производства.



Как с нами связаться

Телефон: 8 (812) 309 58 32 (многоканальный)

Факс: 8 (812) 320-02-42

Электронная почта: org@eplast1.ru

Адрес: 198099, г. Санкт-Петербург, ул. Калинина, дом 2, корпус 4, литера А.