

## RONDA-S-C

~25° spot beam with holder C compatible with LEDiL HEKLA

### TECHNICAL SPECIFICATIONS:

Dimensions	Ø 52.1 mm
Height	17.2 mm
Fastening	socket
ROHS compliant	yes ⓘ

### MATERIAL SPECIFICATIONS:

Component	Type	Material	Colour	Finish
RONDA-S	Single lens	PMMA	clear	
RONDA-HLD-C	Holder	PC	white	



### ORDERING INFORMATION:

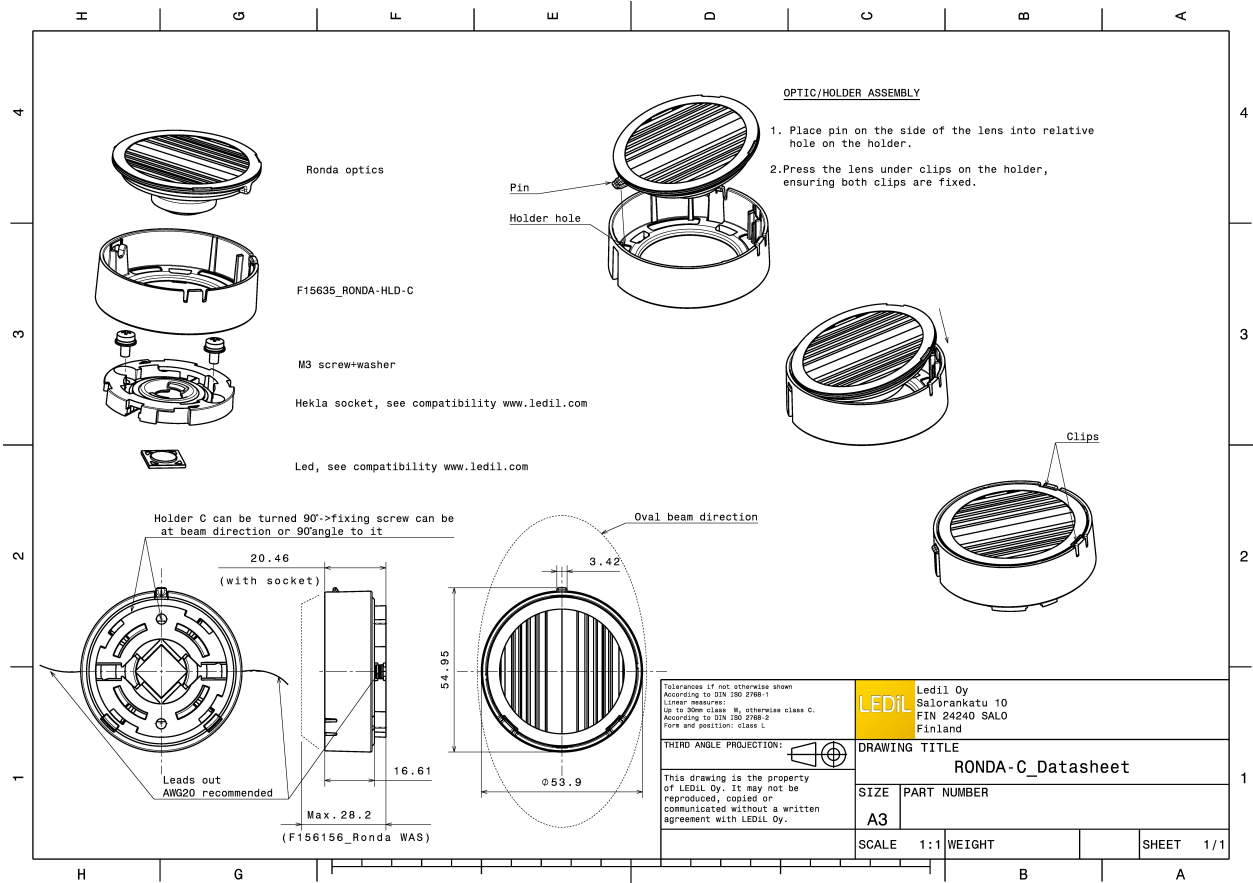

Component		Qty in box	MOQ	MPQ	Box weight (kg)
FN15970_RONDA-S-C	Single lens	420	120	30	0.0
» Box size:					

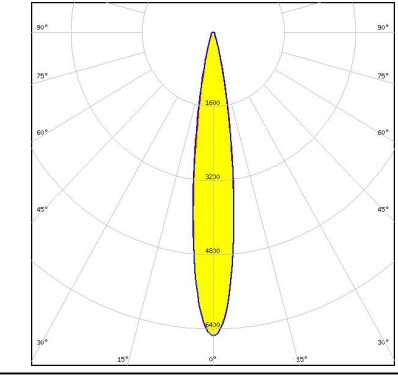
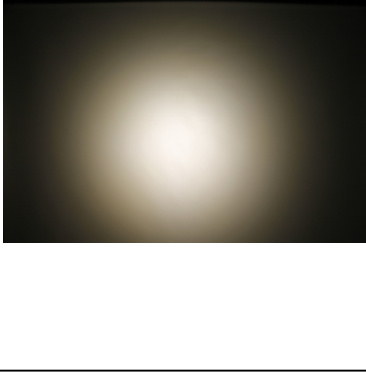
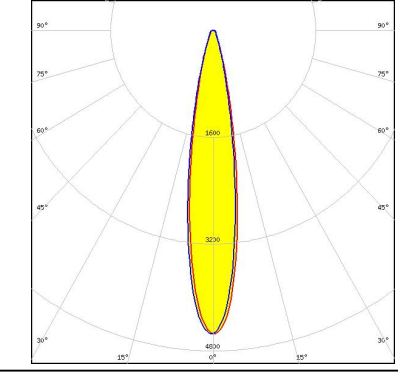
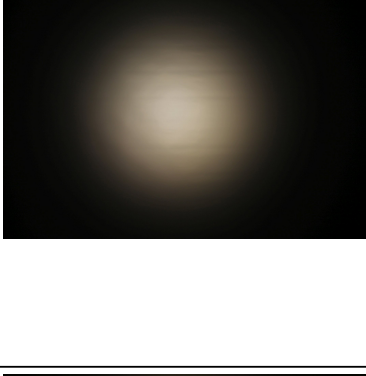
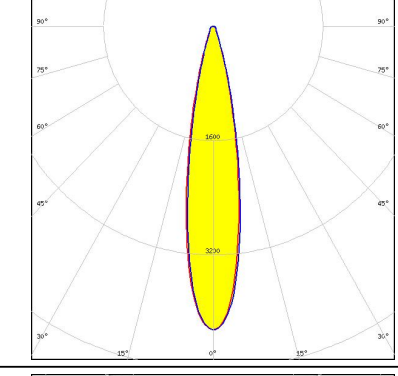
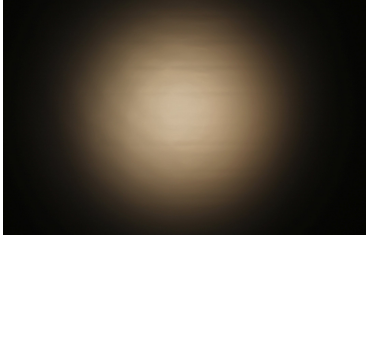
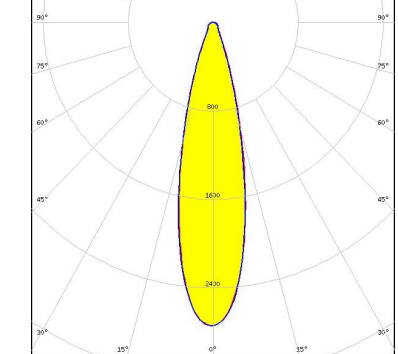

#### PHOTOMETRIC DATA (MEASURED):

<p>bridgelux.</p> <p>LED V4 HD</p> <p>FWHM 16.0°</p> <p>Efficiency 90 %</p> <p>Peak intensity 6.6 cd/lm</p> <p>LEDs/each optic 1</p> <p>Light colour White</p> <p>Required components: F15253_HEKLA-SOCKET-A</p>		
<p>bridgelux.</p> <p>LED V6 Gen6</p> <p>FWHM 18.0°</p> <p>Efficiency 89 %</p> <p>Peak intensity 4.5 cd/lm</p> <p>LEDs/each optic 1</p> <p>Light colour White</p> <p>Required components: F15253_HEKLA-SOCKET-A</p>		
<p>bridgelux.</p> <p>LED V6 HD</p> <p>FWHM 20.0°</p> <p>Efficiency 89 %</p> <p>Peak intensity 4.3 cd/lm</p> <p>LEDs/each optic 1</p> <p>Light colour White</p> <p>Required components: F15255_HEKLA-SOCKET-C</p>		
<p>bridgelux.</p> <p>LED V9 HD</p> <p>FWHM 25.0°</p> <p>Efficiency 87 %</p> <p>Peak intensity 2.7 cd/lm</p> <p>LEDs/each optic 1</p> <p>Light colour White</p> <p>Required components: F15859_HEKLA-SOCKET-I</p>		

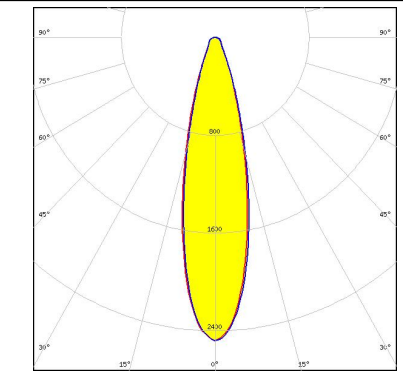
#### PHOTOMETRIC DATA (MEASURED):

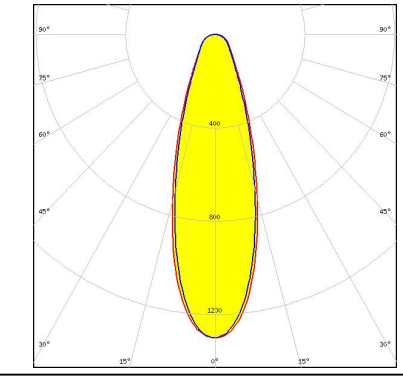
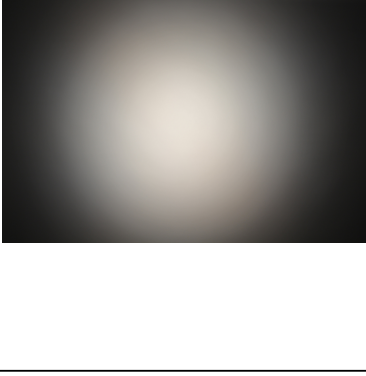
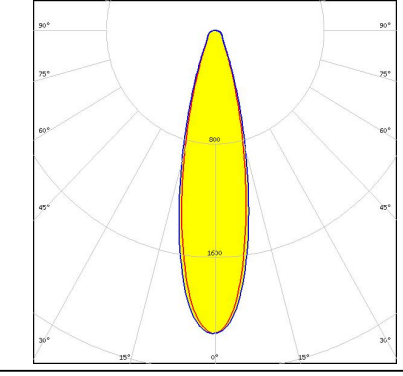
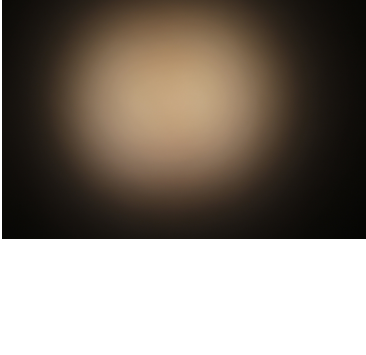
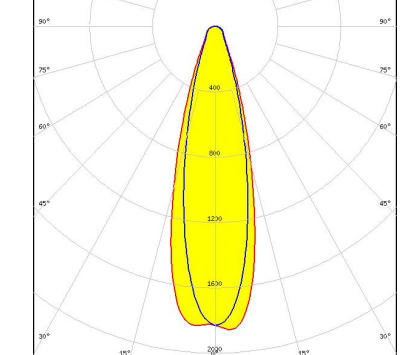
<p>bridgelux.</p> <p>LED VERO10            FWHM 25.0°            Efficiency 87 %            Peak intensity 2.5 cd/lm            LEDs/each optic 1            Light colour White            Required components:            F15616_HEKLA-SOCKET-F</p>		
<p>bridgelux.</p> <p>LED Vesta TW 13mm (25W) CSP            FWHM 32.0°            Efficiency 79 %            Peak intensity 1.3 cd/lm            LEDs/each optic 1            Light colour White            Required components:            C16142_HEKLA-SOCKET-K            Bender Wirth: 492 Typ L8</p>		
<p>bridgelux.</p> <p>LED Vesta TW 9mm (12W) CSP            FWHM 26.0°            Efficiency 82 %            Peak intensity 2.1 cd/lm            LEDs/each optic 1            Light colour White            Required components:            C16142_HEKLA-SOCKET-K            Bender Wirth: 489 Typ L8</p>		
<p><b>CITIZEN</b></p> <p>LED CLC020 Series (Dim-To-Warm)            FWHM 28.0°            Efficiency 81 %            Peak intensity 1.9 cd/lm            LEDs/each optic 1            Light colour White            Required components:            C16142_HEKLA-SOCKET-K</p>		



#### PHOTOMETRIC DATA (MEASURED):

#### CITIZEN

LED CLL02x/CLU02x (LES10)  
 FWHM 26.0°  
 Efficiency 86 %  
 Peak intensity 2.3 cd/lm  
 LEDs/each optic 1  
 Light colour White  
 Required components:  
 F15255\_HEKLA-SOCKET-C

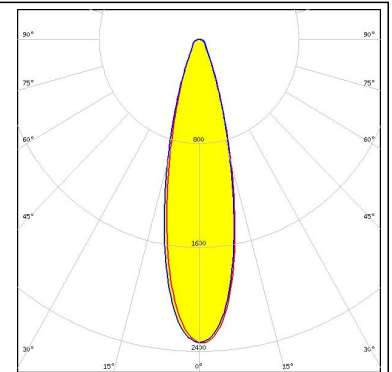

#### CITIZEN

LED CLU700/701/702  
 FWHM 19.0°  
 Efficiency 87 %  
 Peak intensity 4.1 cd/lm  
 LEDs/each optic 1  
 Light colour White  
 Required components:  
 F15255\_HEKLA-SOCKET-C

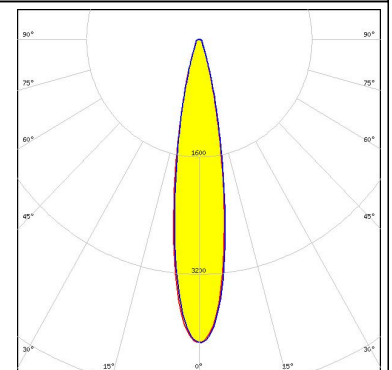
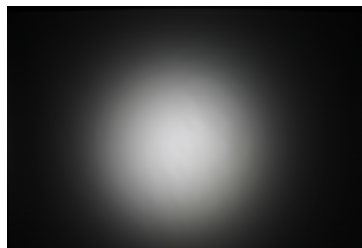

#### CITIZEN

LED CLU7A2 (LES 4.2mm)  
 FWHM 15.0°  
 Efficiency 89 %  
 Peak intensity 6.6 cd/lm  
 LEDs/each optic 1  
 Light colour White  
 Required components:  
 F15255\_HEKLA-SOCKET-C

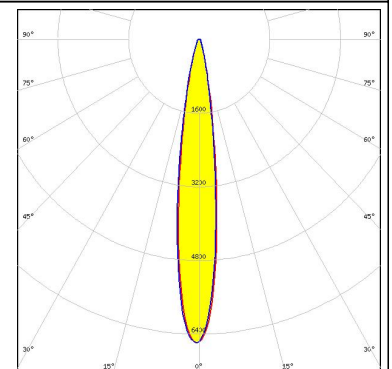
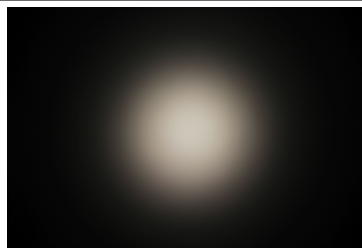

#### CREE

LED CMA1516  
 FWHM 27.0°  
 Efficiency 89 %  
 Peak intensity 2.5 cd/lm  
 LEDs/each optic 1  
 Light colour White  
 Required components:  
 F15256\_HEKLA-SOCKET-D

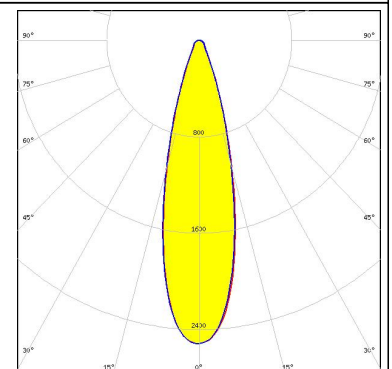
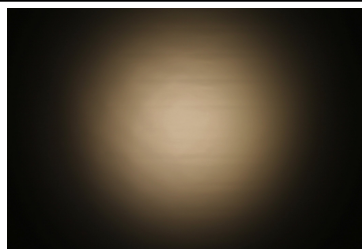

#### PHOTOMETRIC DATA (MEASURED):



LED CMA1825  
 FWHM 33.0°  
 Efficiency 87 %  
 Peak intensity 1.6 cd/lm  
 LEDs/each optic 1  
 Light colour White  
 Required components:  
 F15254\_HEKLA-SOCKET-B

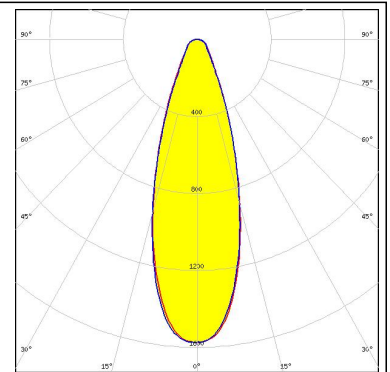
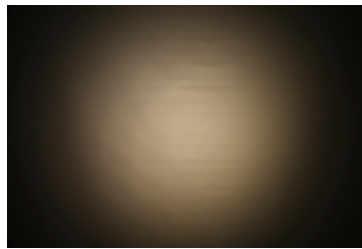

LED CMT14xx  
 FWHM 28.0°  
 Efficiency 88 %  
 Peak intensity 2.3 cd/lm  
 LEDs/each optic 1  
 Light colour White  
 Required components:  
 F15255\_HEKLA-SOCKET-C

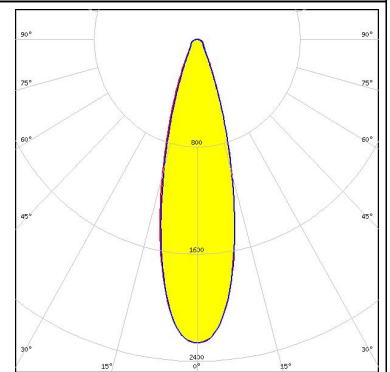
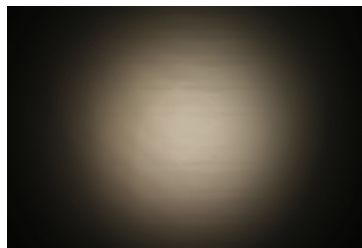

LED CMT19xx  
 FWHM 35.0°  
 Efficiency 82 %  
 Peak intensity 1.2 cd/lm  
 LEDs/each optic 1  
 Light colour White  
 Required components:  
 F15859\_HEKLA-SOCKET-I

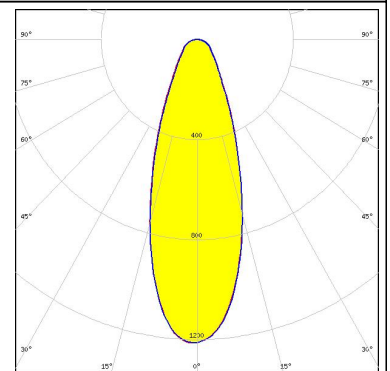
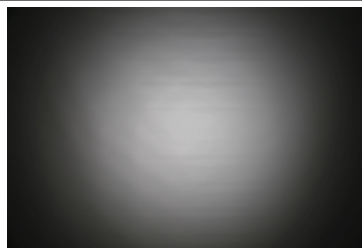

LED CXA/B 13xx  
 FWHM 19.0°  
 Efficiency 88 %  
 Peak intensity 4.4 cd/lm  
 LEDs/each optic 1  
 Light colour White  
 Required components:  
 F15956\_HEKLA-SOCKET-J

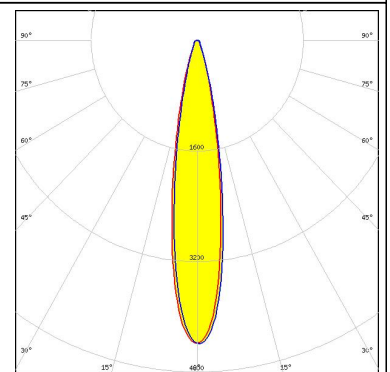
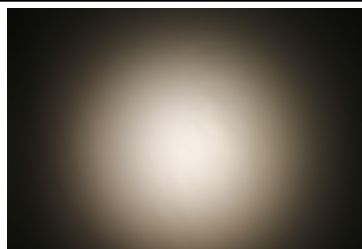

#### PHOTOMETRIC DATA (MEASURED):



LED CXA/B 15xx  
 FWHM 25.0°  
 Efficiency 88 %  
 Peak intensity 2.7 cd/lm  
 LEDs/each optic 1  
 Light colour White  
 Required components:  
 F15256\_HEKLA-SOCKET-D

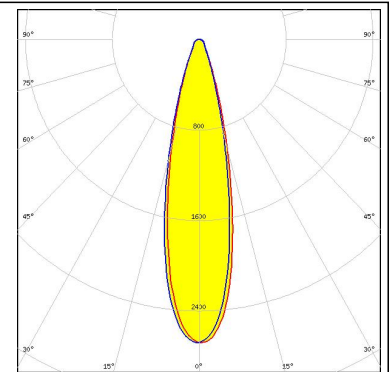

LED LUXEON CoB 1202HD  
 FWHM 21.0°  
 Efficiency 89 %  
 Peak intensity 4.1 cd/lm  
 LEDs/each optic 1  
 Light colour White  
 Required components:  
 F15848\_HEKLA-SOCKET-G

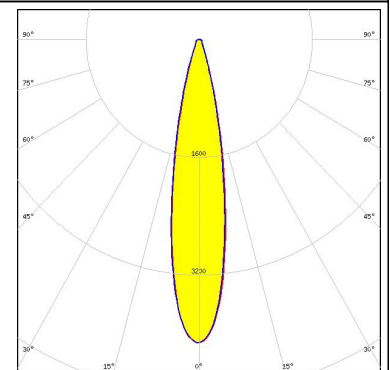
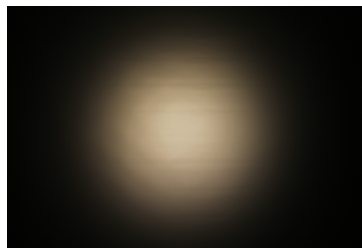

LED LUXEON CoB 1202s  
 FWHM 19.0°  
 Efficiency 89 %  
 Peak intensity 4.4 cd/lm  
 LEDs/each optic 1  
 Light colour White  
 Required components:  
 F15848\_HEKLA-SOCKET-G

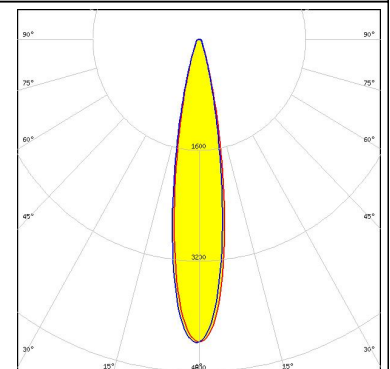
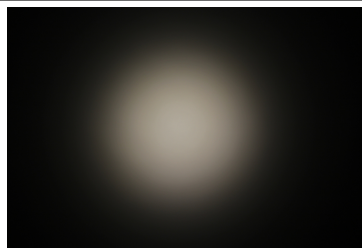

LED LUXEON CoB 1204HD  
 FWHM 27.0°  
 Efficiency 88 %  
 Peak intensity 2.5 cd/lm  
 LEDs/each optic 1  
 Light colour White  
 Required components:  
 F15858\_HEKLA-SOCKET-H

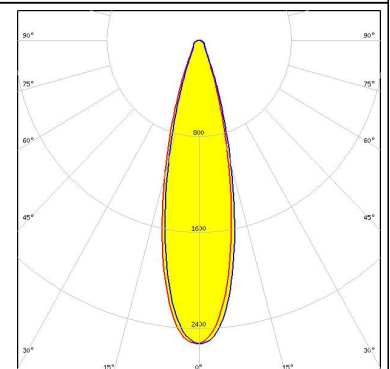
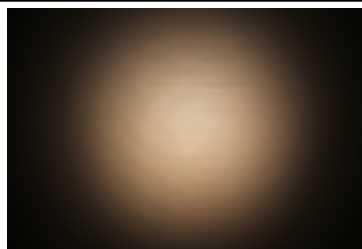

#### PHOTOMETRIC DATA (MEASURED):

#### LUMILEDS

LED LUXEON CoB 1205HD  
 FWHM 31.0°  
 Efficiency 86 %  
 Peak intensity 1.8 cd/lm  
 LEDs/each optic 1  
 Light colour White  
 Required components:  
 F15858\_HEKLA-SOCKET-H

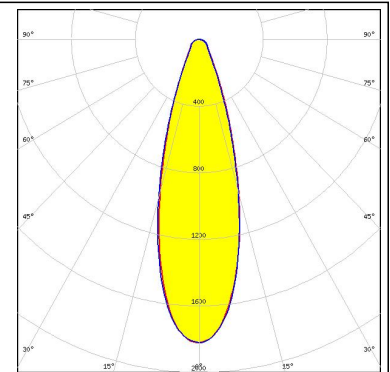
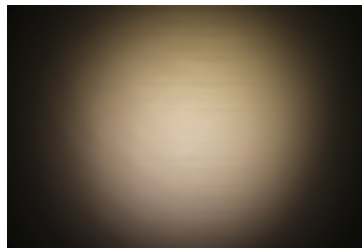

#### LUMILEDS

LED LUXEON CX Plus CoB - HD S01H4  
 FWHM 18.0°  
 Efficiency 89 %  
 Peak intensity 5 cd/lm  
 LEDs/each optic 1  
 Light colour White  
 Required components:  
 Bender Wirth: 634c Hekla

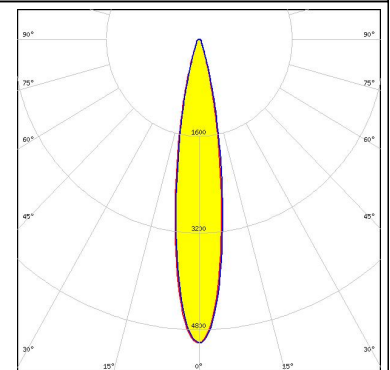
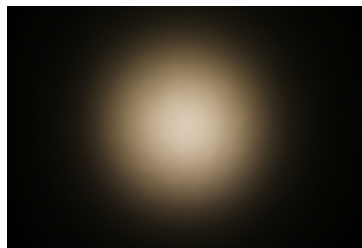

#### LUMILEDS

LED LUXEON CX Plus CoB - HD S01H6 / HD S02H6  
 FWHM 19.0°  
 Efficiency 90 %  
 Peak intensity 4.4 cd/lm  
 LEDs/each optic 1  
 Light colour White  
 Required components:  
 Bender Wirth: 634c Hekla

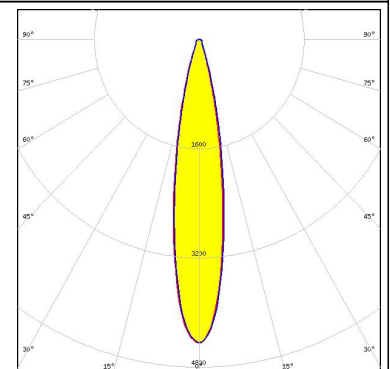
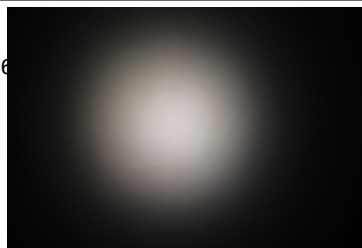

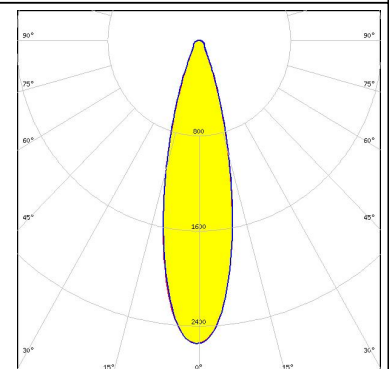
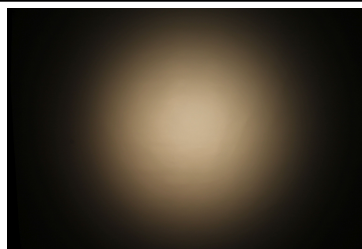

#### LUMILEDS

LED LUXEON CX Plus CoB - HD S04H9  
 FWHM 26.0°  
 Efficiency 88 %  
 Peak intensity 2.6 cd/lm  
 LEDs/each optic 1  
 Light colour White  
 Required components:  
 Bender Wirth: 634c Hekla



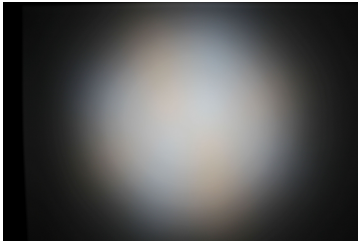
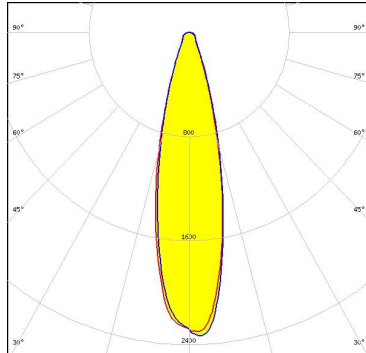
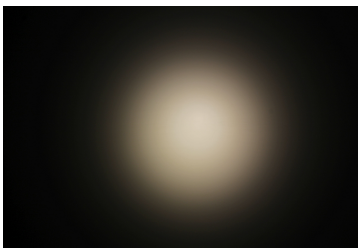
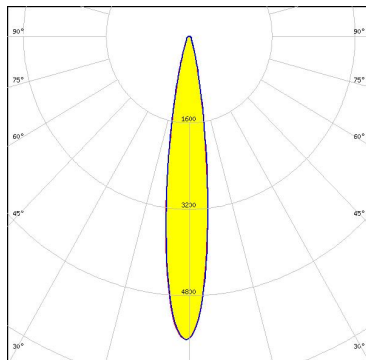

#### PHOTOMETRIC DATA (MEASURED):

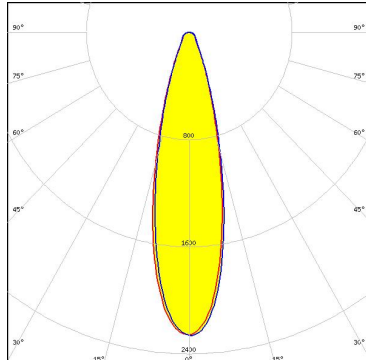
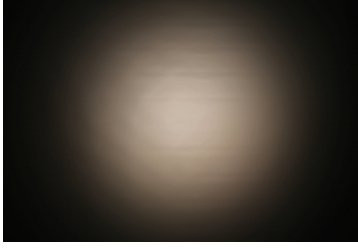
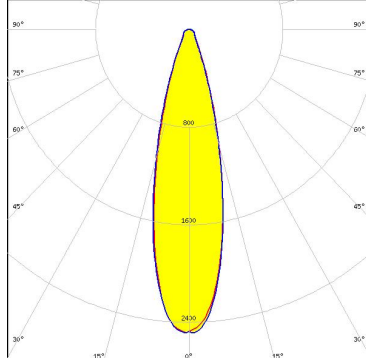
<p><b>LUMINUS</b></p> <p>LED CDM-9 (Dim-To-Warm)            FWHM 26.0°            Efficiency 82 %            Peak intensity 2.3 cd/lm            LEDs/each optic 1            Light colour White            Required components:            C16142_HEKLA-SOCKET-K            Bender Wirth: 490 Typ L8</p>		
<p><b>LUMINUS</b></p> <p>LED CXM-4            FWHM 16.0°            Efficiency 88 %            Peak intensity 5.6 cd/lm            LEDs/each optic 1            Light colour White            Required components:            F15255_HEKLA-SOCKET-C</p>		
<p><b>LUMINUS</b></p> <p>LED CxM-9 (13.5x13.5)            FWHM 27.0°            Efficiency 86 %            Peak intensity 2.3 cd/lm            LEDs/each optic 1            Light colour White            Required components:            F15255_HEKLA-SOCKET-C</p>		
<p><b>PHILIPS</b></p> <p>LED Fortimo SLM L09 CoB            FWHM 26.0°            Efficiency 87 %            Peak intensity 2.5 cd/lm            LEDs/each optic 1            Light colour White            Required components:            F15858_HEKLA-SOCKET-H</p>		



#### PHOTOMETRIC DATA (MEASURED):

### PHILIPS

LED Fortimo SLM L13 CoB  
 FWHM 33.0°  
 Efficiency 80 %  
 Peak intensity 1.3 cd/lm  
 LEDs/each optic 1  
 Light colour White  
 Required components:  
 C16142\_HEKLA-SOCKET-K  
 Bender Wirth: 432 Typ L8

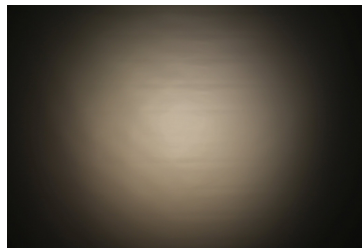

### PHILIPS

LED Fortimo SLM L13 CoB  
 FWHM 33.0°  
 Efficiency 80 %  
 Peak intensity 1.3 cd/lm  
 LEDs/each optic 1  
 Light colour White  
 Required components:  
 C16140\_CLAMP-VERO29  
 Bender Wirth: 432 Typ L8

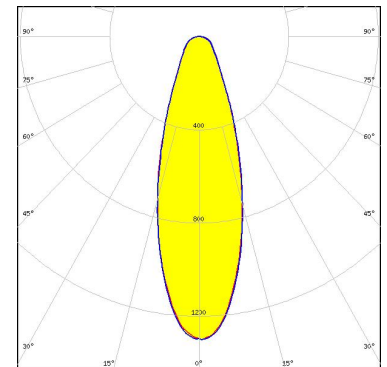
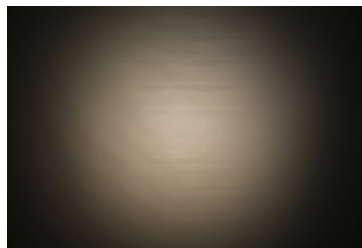

### SAMSUNG

LED LC003D / LC006D / LC009D / LC013D  
 FWHM 27.0°  
 Efficiency 87 %  
 Peak intensity 2.3 cd/lm  
 LEDs/each optic 1  
 Light colour White  
 Required components:  
 F15255\_HEKLA-SOCKET-C

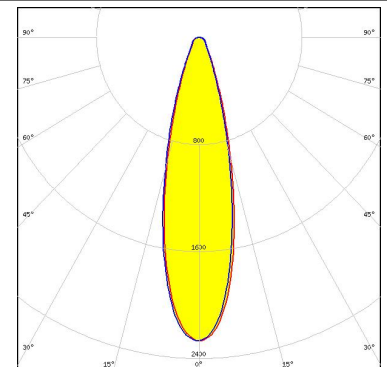
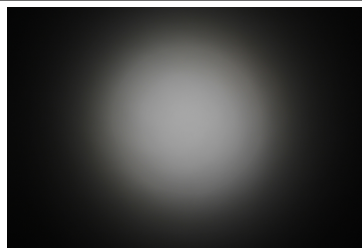

### SAMSUNG

LED LC010C  
 FWHM 20.0°  
 Efficiency 88 %  
 Peak intensity 3.8 cd/lm  
 LEDs/each optic 1  
 Light colour White  
 Required components:  
 F15848\_HEKLA-SOCKET-G

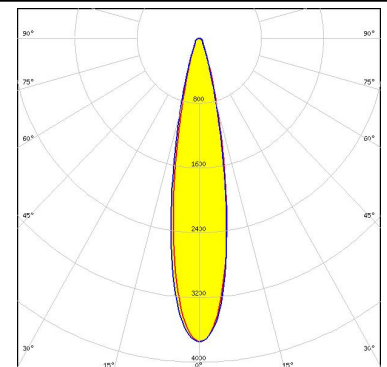
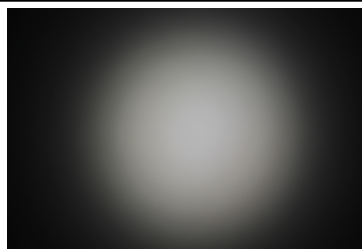

#### PHOTOMETRIC DATA (MEASURED):

#### SAMSUNG

LED LC010C G2  
 FWHM 19.0°  
 Efficiency 87 %  
 Peak intensity 4.3 cd/lm  
 LEDs/each optic 1  
 Light colour White  
 Required components:  
 F15255\_HEKLA-SOCKET-C

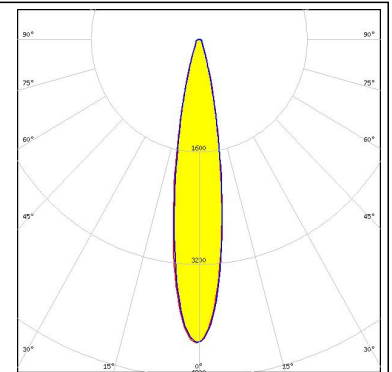

#### SAMSUNG

LED LC010T (Tunable White)  
 FWHM 26.0°  
 Efficiency 82 %  
 Peak intensity 2.1 cd/lm  
 LEDs/each optic 1  
 Light colour Tunable White  
 Required components:  
 C16142\_HEKLA-SOCKET-K  
 Bender Wirth: 501 Typ L8

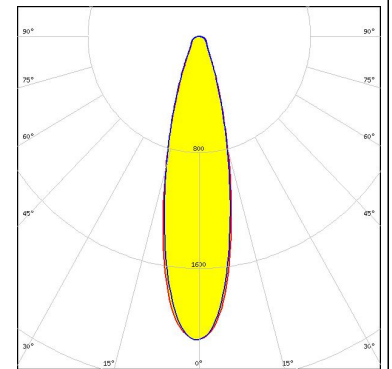
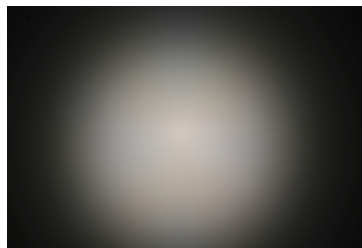

#### SAMSUNG

LED LC016D / LC019D / LC026D / LC033D  
 FWHM 34.0°  
 Efficiency 79 %  
 Peak intensity 1.1 cd/lm  
 LEDs/each optic 1  
 Light colour White  
 Required components:  
 F15859\_HEKLA-SOCKET-I

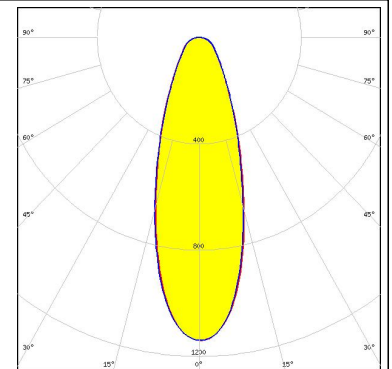
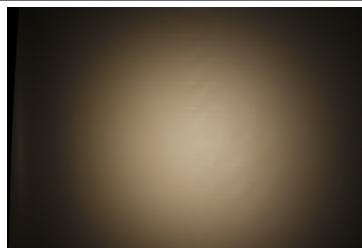

#### SAMSUNG

LED LC020C  
 FWHM 24.0°  
 Efficiency 88 %  
 Peak intensity 2.9 cd/lm  
 LEDs/each optic 1  
 Light colour White  
 Required components:  
 F15848\_HEKLA-SOCKET-G

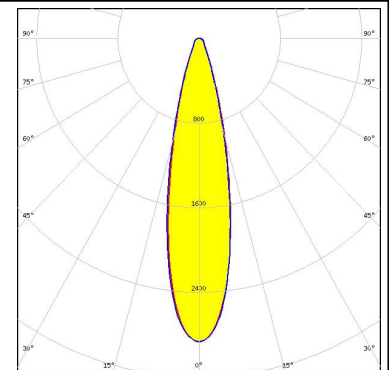
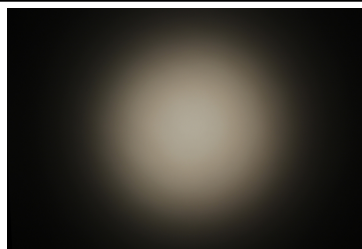

#### PHOTOMETRIC DATA (MEASURED):

### SAMSUNG

LED LC020C G2  
 FWHM 25.0°  
 Efficiency 85 %  
 Peak intensity 2.5 cd/lm  
 LEDs/each optic 1  
 Light colour White  
 Required components:  
 F15859\_HEKLA-SOCKET-I

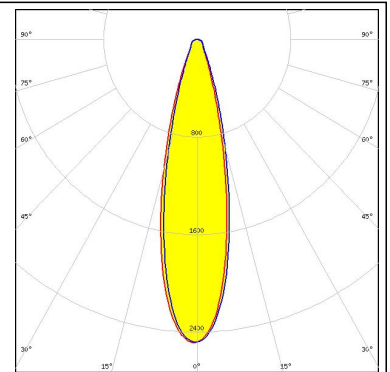
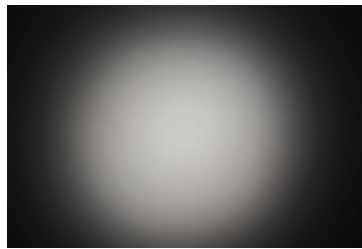

### SAMSUNG

LED LC020T (Tunable white)  
 FWHM 33.0°  
 Efficiency 79 %  
 Peak intensity 1.3 cd/lm  
 LEDs/each optic 1  
 Light colour Tunable White  
 Required components:  
 C16142\_HEKLA-SOCKET-K  
 Bender Wirth: 501 Typ L8

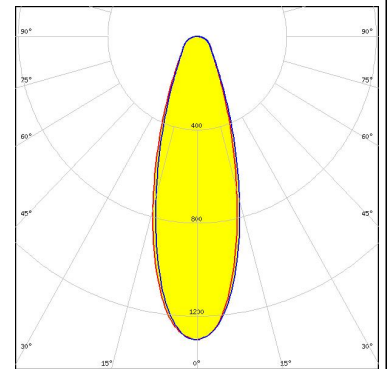
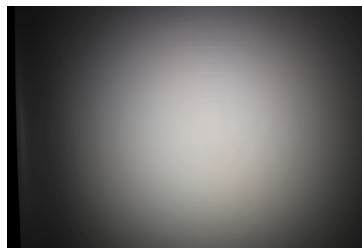

SEOUL SEMICONDUCTOR

LED MJT COB LES 6  
 FWHM 19.0°  
 Efficiency 85 %  
 Peak intensity 4.1 cd/lm  
 LEDs/each optic 1  
 Light colour White  
 Required components:  
 F15255\_HEKLA-SOCKET-C

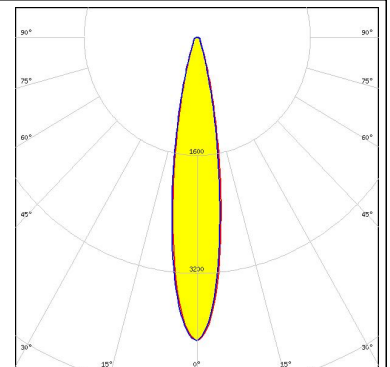
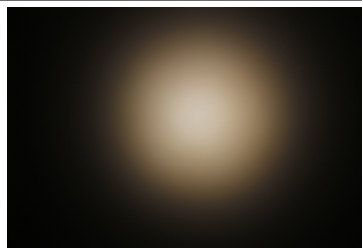

SEOUL SEMICONDUCTOR

LED MJT COB LES 9.8  
 FWHM 27.0°  
 Efficiency 83 %  
 Peak intensity 2.1 cd/lm  
 LEDs/each optic 1  
 Light colour White  
 Required components:  
 F15255\_HEKLA-SOCKET-C

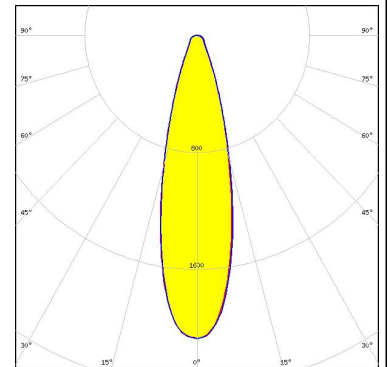
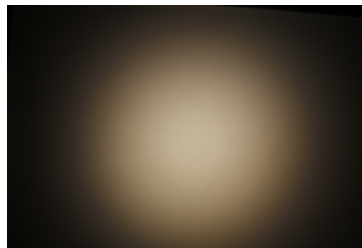

#### PHOTOMETRIC DATA (MEASURED):

#### TRIDONIC

LED SLE G7 LES09  
FWHM 26.0°  
Efficiency 86 %  
Peak intensity 2.5 cd/lm  
LEDs/each optic 1  
Light colour White  
Required components:  
F15255\_HEKLA-SOCKET-C

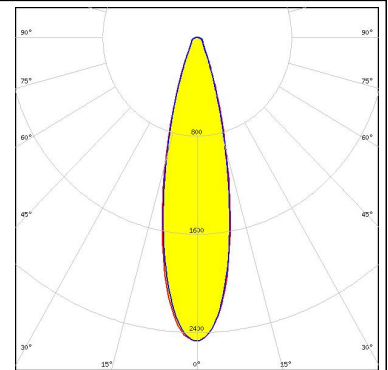
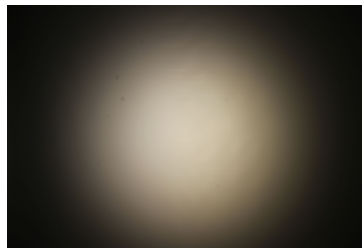

#### TRIDONIC

LED SLE G7 LES13  
FWHM 33.0°  
Efficiency 81 %  
Peak intensity 1.3 cd/lm  
LEDs/each optic 1  
Light colour White  
Required components:  
F15859\_HEKLA-SOCKET-I

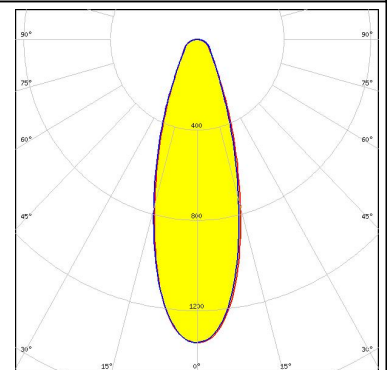
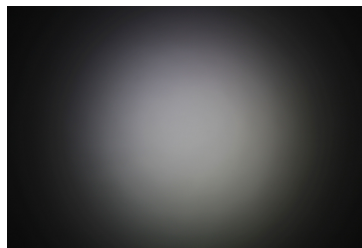

#### TRIDONIC

LED SLE G7 LES15  
FWHM 34.0°  
Efficiency 80 %  
Peak intensity 1.2 cd/lm  
LEDs/each optic 1  
Light colour White  
Required components:  
F15859\_HEKLA-SOCKET-I

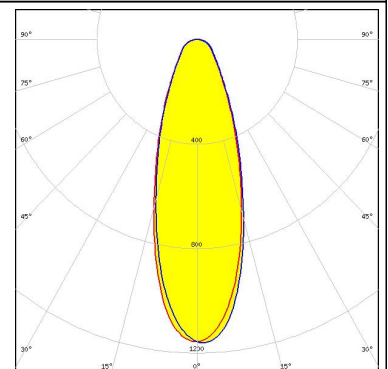
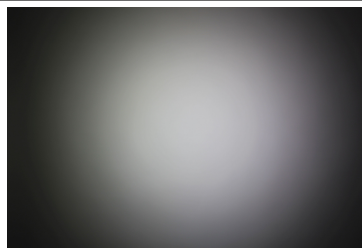

#### XICATO

LED XOB 14.5 mm  
FWHM 34.0°  
Efficiency 80 %  
Peak intensity 1.2 cd/lm  
LEDs/each optic 1  
Light colour White  
Required components:  
F15859\_HEKLA-SOCKET-I

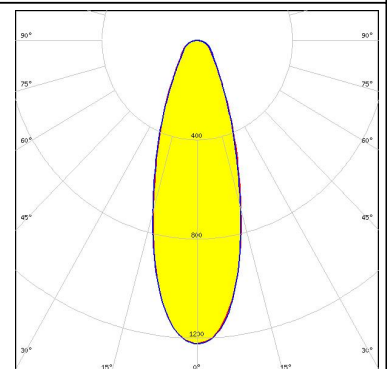
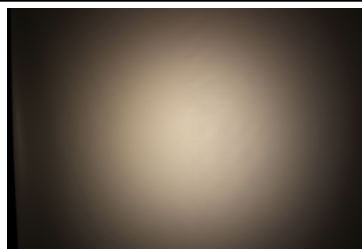

#### PHOTOMETRIC DATA (MEASURED):

#### XICATO

LED XOB 9.8 mm  
FWHM 25.0°  
Efficiency 87 %  
Peak intensity 2.5 cd/lm  
LEDs/each optic 1  
Light colour White  
Required components:  
F15255\_HEKLA-SOCKET-C

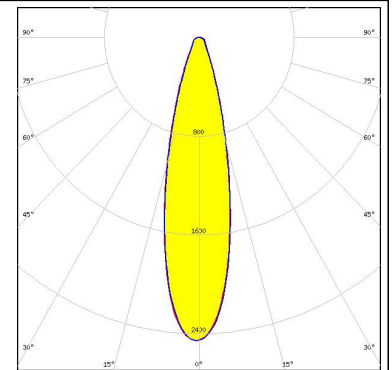

#### XICATO

LED XTM - 19mm LES  
FWHM 36.0°  
Efficiency 80 %  
Peak intensity 0.9 cd/lm  
LEDs/each optic 1  
Light colour White  
Required components:  
C16058\_XTM-ADAPTER-50-C

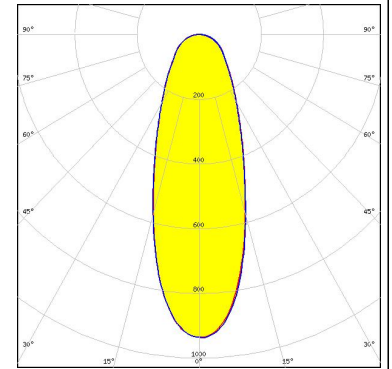
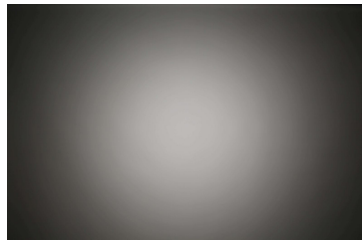



#### PHOTOMETRIC DATA (SIMULATED):

#### CITIZEN

LED CLL03x/CLU03x  
FWHM 28.0°  
Efficiency 82 %  
Peak intensity 1.8 cd/lm  
LEDs/each optic 1  
Light colour White  
Required components:  
F15859\_HEKLA-SOCKET-I

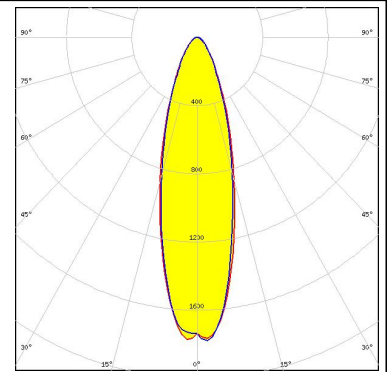

#### CREE

LED CMT14xx  
FWHM 16.0°  
Efficiency 83 %  
Peak intensity 3.4 cd/lm  
LEDs/each optic 1  
Light colour White  
Required components:  
F15255\_HEKLA-SOCKET-C

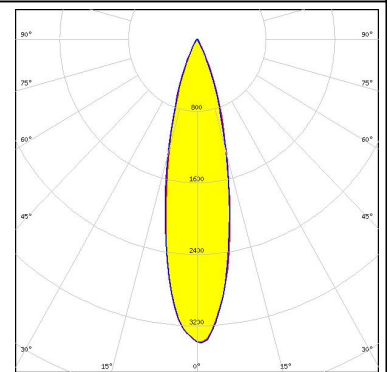

#### NICHIA

LED COB T-Type  
FWHM 19.0°  
Efficiency 85 %  
Peak intensity 5.7 cd/lm  
LEDs/each optic 1  
Light colour White  
Required components:  
F15848\_HEKLA-SOCKET-G

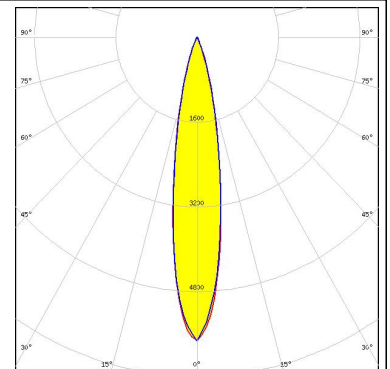

#### GENERAL INFORMATION:

NOTE: The typical beam angle will be changed by different color, chip size and chip position tolerance. The typical total beam angle is the full angle measured where the luminous intensity is half of the peak value.

Due to use of high power COB's with this product, special attention to proper thermal design is highly recommended. LEDiL has no liability for direct, indirect or consecutive damages arising from the LEDiL products being used outside of the recommended temperature range.

#### MATERIALS:

As part of our continuous research and improvement processes, and to ensure the best possible quality and availability of our products, LEDiL reserves the right to change material grades without notice.

#### PRODUCT DATA USER AGREEMENT AND DISCLAIMER:

The measured data in the provided downloadable LEDiL Product Datasheets and Mechanical 2D-Drawings is rounded and provided as reference for planning. LEDiL Oy's optical specifications have been verified by conducting performance testing of the products in accordance with the company's quality system. The reported data are averaged results of multiple measurements with typical variation. LEDiL Oy reserves the right to without prior notification make changes and improvements to its products.

LEDiL Oy assumes neither warranty, nor guarantee nor any other liability of any kind for the contents and correctness of the provided data. The provided data has been generated with highest diligence but the provided data may in reality not represent the complete possible variation range of all intrinsic parameters. Therefore, in certain cases a deviation from the provided data could occur.

LEDiL Oy reserves the right to undertake technical changes of its products without further notification which could lead to changes in the provided data. LEDiL Oy assumes no liability of any kind for the possible deviation from any provided data or any other damage resulting from the usage of the provided data.

The user agrees to this disclaimer and user agreement with the download or usage of the provided files.

#### LEDiL Oy

Joensuunkatu 13  
FI-24240 SALO  
Finland

#### LEDiL Inc.

228 West Page Street  
Suite D  
Sycamore IL 60178  
USA

#### Local sales and technical support

[www.ledil.com/where\\_to\\_buy](http://www.ledil.com/where_to_buy)

#### Shipping locations

Salo, Finland  
Hong Kong, China

#### Distribution Partners

[www.ledil.com/where\\_to\\_buy](http://www.ledil.com/where_to_buy)



Компания «ЭлектроПласт» предлагает заключение долгосрочных отношений при поставках импортных электронных компонентов на взаимовыгодных условиях!

Наши преимущества:

- Оперативные поставки широкого спектра электронных компонентов отечественного и импортного производства напрямую от производителей и с крупнейших мировых складов;
- Поставка более 17-ти миллионов наименований электронных компонентов;
- Поставка сложных, дефицитных, либо снятых с производства позиций;
- Оперативные сроки поставки под заказ (от 5 рабочих дней);
- Экспресс доставка в любую точку России;
- Техническая поддержка проекта, помощь в подборе аналогов, поставка прототипов;
- Система менеджмента качества сертифицирована по Международному стандарту ISO 9001;
- Лицензия ФСБ на осуществление работ с использованием сведений, составляющих государственную тайну;
- Поставка специализированных компонентов (Xilinx, Altera, Analog Devices, Intersil, Interpoint, Microsemi, Aeroflex, Peregrine, Syfer, Eurofarad, Texas Instrument, Miteq, Cobham, E2V, MA-COM, Hittite, Mini-Circuits, General Dynamics и др.);

Помимо этого, одним из направлений компании «ЭлектроПласт» является направление «Источники питания». Мы предлагаем Вам помощь Конструкторского отдела:

- Подбор оптимального решения, техническое обоснование при выборе компонента;
- Подбор аналогов;
- Консультации по применению компонента;
- Поставка образцов и прототипов;
- Техническая поддержка проекта;
- Защита от снятия компонента с производства.



#### Как с нами связаться

**Телефон:** 8 (812) 309 58 32 (многоканальный)

**Факс:** 8 (812) 320-02-42

**Электронная почта:** [org@eplast1.ru](mailto:org@eplast1.ru)

**Адрес:** 198099, г. Санкт-Петербург, ул. Калинина, дом 2, корпус 4, литера А.