

The S-8424A Series is a CMOS IC designed for use in the switching circuits of primary and backup power supplies on a single chip. It consists of two voltage regulators, three voltage detectors, a power supply switch and its controller, as well as other functions.

In addition to the switching function between the primary and backup power supply, the S-8424A Series can provide the micro controllers with three types of voltage detection output signals corresponding to the power supply voltage. Moreover adopting a special sequence for switch control enables the effective use of the backup power supply, making this IC ideal for configuring a backup system.

■ Features

- Low power consumption
 - Normal operation: 15 μ A Max. ($V_{IN} = 6$ V)
 - Backup: 2.1 μ A Max.
- Voltage regulator
 - Output voltage tolerance : ± 2 %
 - Output voltage: Independently selectable in 0.1 V steps in the range of 2.3 V to 5.4 V
- Three built-in voltage detectors (CS, $\overline{\text{PREEND}}$, $\overline{\text{RESET}}$)
 - Detection voltage precision: ± 2 %
 - Detection voltage: Selectable in 0.1 V steps in the range of 2.4 V to 5.3 V (CS voltage detector)
 - Selectable in 0.1 V steps in the range of 1.7 V to 3.4 V ($\overline{\text{PREEND}}$, $\overline{\text{RESET}}$ voltage detector)
- Switching circuit for primary power supply and backup power supply configurable on one chip
- Efficient use of backup power supply possible
- Special sequence
 - Backup voltage is not output when the primary power supply voltage does not reach the initial voltage at which the switch unit operates.
- Lead-free, Sn 100%, halogen-free*1

*1. Refer to “**■ Product Name Structure**” for details.

■ Packages

- 8-Pin TSSOP
- 8-Pin SON(B)

■ Applications

- Video camera recorders
- Still video cameras
- Memory cards
- SRAM backup equipment

■ Product Name Structure

1. Product name

(1) 8-Pin TSSOP

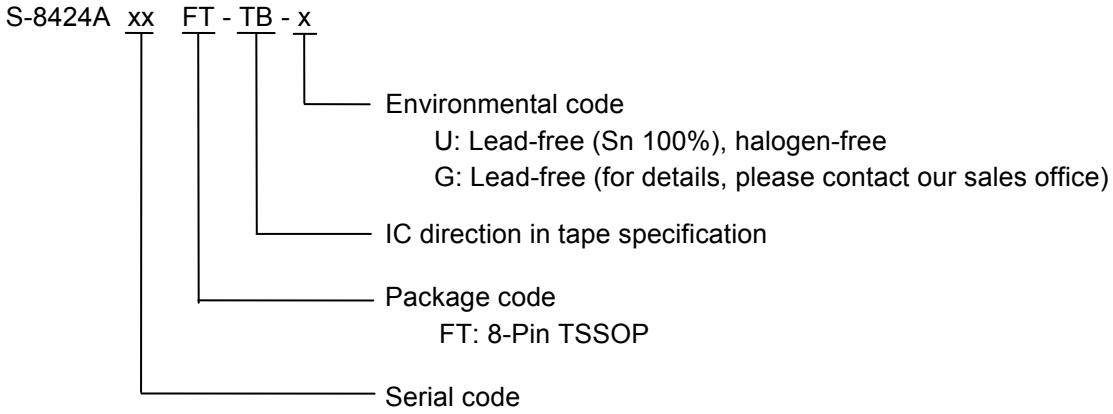

(2) 8-Pin SON(B)

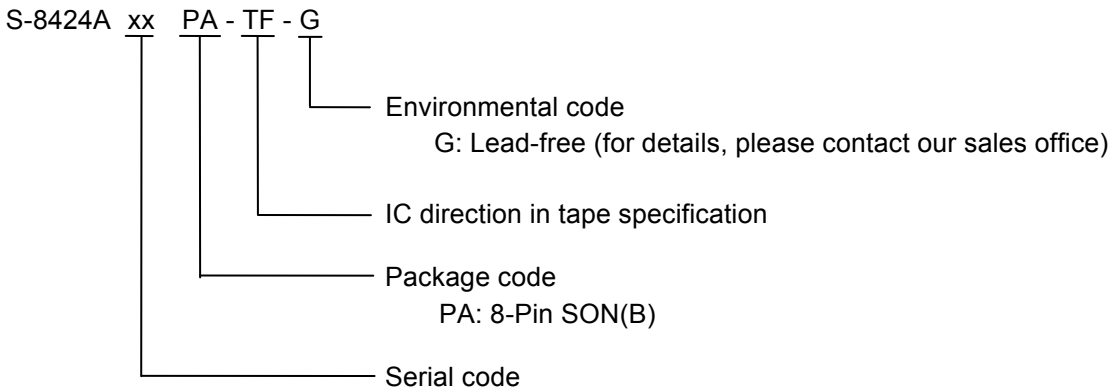

2. Package

Package Name		Drawing Code		
		Package	Tape	Reel
8-Pin TSSOP	Environmental code = G	FT008-A-P-SD	FT008-E-C-SD	FT008-E-R-SD
	Environmental code = U	FT008-A-P-SD	FT008-E-C-SD	FT008-E-R-S1
8-Pin SON(B)		PA008-B-P-SD	PA008-B-C-SD	PA008-B-R-SD

3. Product name list

Type	Part No.	Package	Output Voltage (V)		CS Voltage (V)		RESET Voltage (V)		PREEND Voltage (V)		Switch Voltage (V)
			V _{RO}	V _{OUT}	-V _{DET1}	+V _{DET1}	-V _{DET2}	+V _{DET2}	-V _{DET3}	+V _{DET3}	V _{SW1}
	S-8424AAAFT-TB-x	8-Pin TSSOP	3.000	3.000	3.300	3.401	2.200	2.312	2.600	2.748	+V _{DET1} × 0.85
	S-8424AAAPA-TF-G	8-Pin SON(B)									
	S-8424AABFT-TB-x	8-Pin TSSOP	3.300	3.300	4.000	4.129	2.300	2.420	2.500	2.640	+V _{DET1} × 0.77
	S-8424AACFT-TB-x	8-Pin TSSOP	3.200	3.200	3.300	3.401	2.400	2.528	2.600	2.748	+V _{DET1} × 0.85
	S-8424AADFT-TB-x	8-Pin TSSOP	5.000	5.000	4.600	4.753	2.300	2.420	2.500	2.640	+V _{DET1} × 0.77
	S-8424AAEFT-TB-x	8-Pin TSSOP	3.150	3.150	4.200	4.337	2.300	2.420	2.500	2.640	+V _{DET1} × 0.77
	S-8424AAFFT-TB-x	8-Pin TSSOP	3.200	3.200	4.400	4.545	2.400	2.528	2.600	2.748	+V _{DET1} × 0.77
	S-8424AAGFT-TB-x	8-Pin TSSOP	2.800	2.800	4.400	4.545	2.400	2.528	2.600	2.748	+V _{DET1} × 0.77
	S-8424AAHFT-TB-x	8-Pin TSSOP	5.000	5.000	4.600	4.753	2.550	2.690	2.700	2.856	+V _{DET1} × 0.77
	S-8424AAJFT-TB-x	8-Pin TSSOP	3.100	3.100	4.400	4.545	2.200	2.312	2.600	2.748	+V _{DET1} × 0.77
	S-8424AAKFT-TB-x	8-Pin TSSOP	3.200	3.200	4.600	4.753	2.400	2.528	2.600	2.748	+V _{DET1} × 0.77

Caution Set the CS voltage so that the switch voltage (V_{SW1}) is equal to or greater than the RESET detection voltage (-V_{DET2}).

Remark 1. The selection range is as follows.

- V_{RO}, V_{OUT}: 2.3 to 5.4 V (0.1 V steps)
- V_{DET1}: 2.4 to 5.3 V (0.1 V steps)
- V_{DET2}: 1.7 to 3.4 V (0.1 V steps)
- V_{DET3}: 1.7 to 3.4 V (0.1 V steps)
- V_{SW1}: +V_{DET1} × 0.85 or +V_{DET1} × 0.77

2. If a product with a voltage other than above is required, contact our sales representative.

3. x: G or U

4. Please select products of environmental code = U for Sn 100%, halogen-free products.

■ Block Diagram

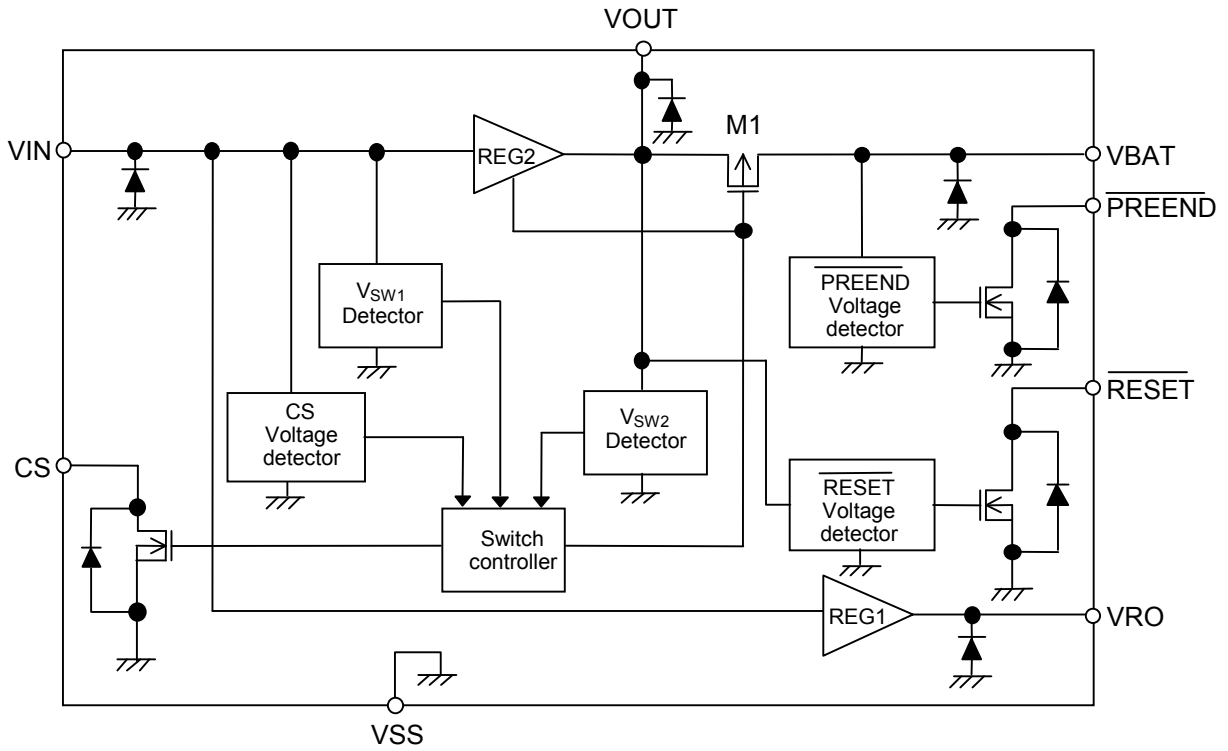

Figure 1 Block Diagram

■ Pin Configurations

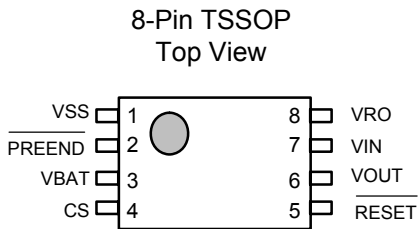

Figure 2

Table 1

Pin No.	Symbol	Description
1	VSS	Ground
2	$\overline{\text{PREEND}}$	Output pin of $\overline{\text{PREEND}}$ voltage detector
3	VBAT* ¹	Backup power supply input pin
4	CS	Output pin of CS voltage detector
5	$\overline{\text{RESET}}$	Output pin of $\overline{\text{RESET}}$ voltage detector
6	VOUT* ²	Output pin of voltage regulator 2
7	VIN* ³	Primary power supply input pin
8	VRO* ⁴	Output pin of voltage regulator 1

*1 to *4. Mount capacitors between VSS (GND pin) and the VIN, VBAT, VOUT, and VRO pins. (Refer to the “**Standard Circuit**”)

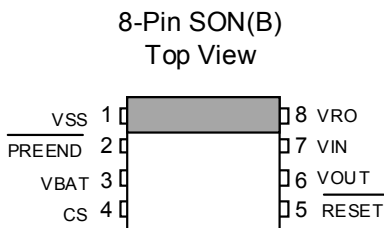

Figure 3

Table 2

Pin No.	Symbol	Description
1	VSS	Ground
2	$\overline{\text{PREEND}}$	Output pin of $\overline{\text{PREEND}}$ voltage detector
3	VBAT* ¹	Backup power supply input pin
4	CS	Output pin of CS voltage detector
5	$\overline{\text{RESET}}$	Output pin of $\overline{\text{RESET}}$ voltage detector
6	VOUT* ²	Output pin of voltage regulator 2
7	VIN* ³	Primary power supply input pin
8	VRO* ⁴	Output pin of voltage regulator 1

*1 to *4. Mount capacitors between VSS (GND pin) and the VIN, VBAT, VOUT, and VRO pins. (Refer to the “**Standard Circuit**”)

■ Absolute Maximum Ratings

Table 3 Absolute Maximum Ratings

(Unless otherwise specified: Ta = 25°C)

Parameter	Symbol	Ratings	Unit
Primary power supply input voltage	V _{IN}	V _{SS} -0.3 to V _{SS} +18	V
Backup power supply input voltage	V _{BAT}		
Output voltage of voltage regulator	V _{RO} , V _{OUT}	V _{SS} -0.3 to V _{IN} +0.3	
CS output voltage	V _{CS}	V _{SS} -0.3 to V _{SS} +18	
RESET output voltage	V _{RESET}		
PREEND output voltage	V _{PREEND}		
Power dissipation	8-Pin TSSOP	P _D	mW
	8-Pin SON(B)		
		300 (When not mounted on board)	
		700*1	
		300 (When not mounted on board)	
		750*1	
Operating ambient temperature	T _{opr}	-40 to +85	°C
Storage temperature	T _{stg}	-40 to +125	

*1. When mounted on board

[Mounted board]

- (1) Board size: 114.3 mm × 76.2 mm × t1.6 mm
- (2) Board name: JEDEC STANDARD51-7

Caution The absolute maximum ratings are rated values exceeding which the product could suffer physical damage. These values must therefore not be exceeded under any conditions.

(1) When mounted on board

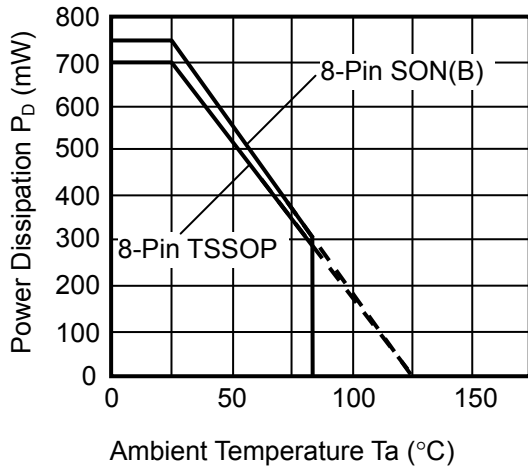

(2) When not mounted on board

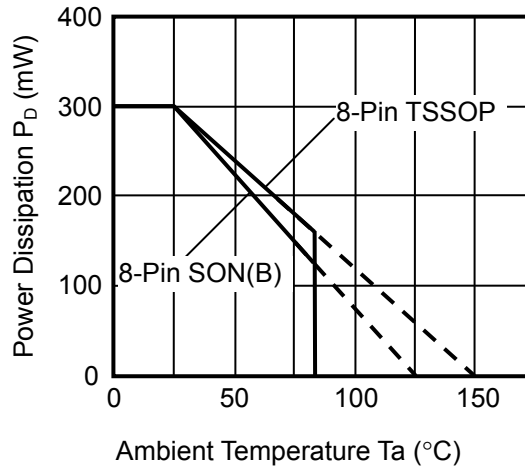

Figure 4 Power Dissipation of Package

■ Electrical Characteristics

1. S-8424AAxx

Table 4 Electrical Characteristics

(Unless otherwise specified: Ta = 25°C)

	Parameter	Symbol	Conditions	Min.	Typ.	Max.	Unit	Test Circuit
Voltage regulator	Output voltage 1	V_{RO}	$V_{IN} = 7.2\text{ V}, I_{RO} = 3\text{ mA}$	2.940	3.000	3.060	V	1
	Dropout voltage 1	V_{drop1}	$V_{IN} = 7.2\text{ V}, I_{RO} = 3\text{ mA}$	—	41	59	mV	
	Load stability 1	ΔV_{RO1}	$V_{IN} = 7.2\text{ V}, I_{RO} = 0.1\text{ to }10\text{ mA}$	—	50	100	mV	
	Input stability 1	ΔV_{RO2}	$V_{IN} = 4\text{ to }16\text{ V}, I_{RO} = 3\text{ mA}$	—	5	20	mV	
	Output voltage temperature coefficient 1	$\frac{\Delta V_{RO}}{\Delta T_a \bullet V_{RO}}$	Ta = -40°C to +85°C	—	±100	—	ppm/°C	
	Output voltage 2	V_{OUT}	$V_{IN} = 7.2\text{ V}, I_{OUT} = 23\text{ mA}$	2.940	3.000	3.060	V	
	Dropout voltage 2	V_{drop2}	$V_{IN} = 7.2\text{ V}, I_{OUT} = 23\text{ mA}$	—	187	252	mV	
	Load stability 2	ΔV_{OUT1}	$V_{IN} = 7.2\text{ V}, I_{OUT} = 0.1\text{ to }60\text{ mA}$	—	50	100	mV	
	Input stability 2	ΔV_{OUT2}	$V_{IN} = 4\text{ to }16\text{ V}, I_{OUT} = 23\text{ mA}$	—	5	20	mV	
	Output voltage temperature coefficient 2	$\frac{\Delta V_{OUT}}{\Delta T_a \bullet V_{OUT}}$	Ta = -40°C to +85°C	—	±100	—	ppm/°C	
	Primary power input voltage	V_{IN}	—	—	—	16	V	
Voltage detector	CS detection voltage	$-V_{DET1}$	V_{IN} voltage detection	3.234	3.300	3.366	V	2
	CS release voltage	$+V_{DET1}$	—	3.319	3.401	3.482	V	
	RESET detection voltage	$-V_{DET2}$	V_{OUT} voltage detection	2.156	2.200	2.244	V	
	RESET release voltage	$+V_{DET2}$	—	2.256	2.312	2.367	V	
	PREEND detection voltage	$-V_{DET3}$	V_{BAT} voltage detection	2.548	2.600	2.652	V	
	PREEND release voltage	$+V_{DET3}$	—	2.682	2.748	2.814	V	
	Operating voltage	V_{opr}	V_{IN} or V_{BAT}	1.7	—	16	V	
	Detection voltage temperature coefficient	$\frac{\Delta - V_{DET1}}{\Delta T_a \bullet -V_{DET1}}$	Ta = -40°C to +85°C	—	±100	—	ppm/°C	
			Ta = -40°C to +85°C	—	±100	—	ppm/°C	
			Ta = -40°C to +85°C	—	±100	—	ppm/°C	
Sink current	I_{SINK}	$V_{DS} = 0.5\text{ V}, V_{IN} = V_{BAT} = 2.0\text{ V}$	RESET	1.50	2.30	—	mA	
			PREEND	1.50	2.30	—	mA	
			CS	1.50	2.30	—	mA	
Leakage current	I_{LEAK}	$V_{DS} = 16\text{ V}, V_{IN} = 16\text{ V}$	—	—	0.1	μA		
Switch unit	Switch voltage	V_{SW1}	$V_{BAT} = 2.8\text{ V}, V_{IN}$ voltage detection	$+V_{DET1} \times 0.83$	$+V_{DET1} \times 0.85$	$+V_{DET1} \times 0.87$	V	4
	CS output inhibit voltage	V_{SW2}	$V_{BAT} = 3.0\text{ V}, V_{OUT}$ voltage detection	$V_{OUT} \times 0.93$	$V_{OUT} \times 0.95$	$V_{OUT} \times 0.97$	V	
	V_{BAT} switch leakage current	I_{LEAK}	$V_{IN} = 3.6\text{ V}, V_{BAT} = 0\text{ V}$	—	—	0.1	μA	
	V_{BAT} switch resistance	R_{SW}	$V_{IN} = \text{Open}, V_{BAT} = 3.0\text{ V}, I_{OUT} = 10\text{ to }500\text{ }\mu\text{A}$	—	30	60	Ω	
	Switch voltage temperature coefficient	$\frac{\Delta V_{SW1}}{\Delta T_a \bullet V_{SW1}}$	Ta = -40°C to +85°C	—	±100	—	ppm/°C	
	CS output inhibit voltage temperature coefficient	$\frac{\Delta V_{SW2}}{\Delta T_a \bullet V_{SW2}}$	Ta = -40°C to +85°C	—	±100	—	ppm/°C	
Total	Current consumption	I_{SS1}	$V_{IN} = 3.6\text{ V}, V_{BAT} = 3.0\text{ V}, \text{Unload}$	—	7	15	μA	
				—	0.26	0.50	μA	
		I_{BAT1}	$V_{IN} = \text{Open}, V_{BAT} = 3.0\text{ V}, \text{Unload}$	Ta = 25°C	—	1.0	2.1	μA
				Ta = 85°C	—	—	3.5	μA
Backup power supply input voltage	V_{BAT}	—	1.7	—	4.0	V	7	

Remark The number in the Test Circuit column corresponds to the circuit number in the "Test Circuit" section.

2. S-8424AABxx

Table 5 Electrical Characteristics

(Unless otherwise specified: Ta = 25°C)

	Parameter	Symbol	Conditions	Min.	Typ.	Max.	Unit	Test Circuit
Voltage regulator	Output voltage 1	V_{RO}	$V_{IN} = 6\text{ V}, I_{RO} = 30\text{ mA}$	3.234	3.300	3.366	V	1
	Dropout voltage 1	V_{drop1}	$V_{IN} = 6\text{ V}, I_{RO} = 30\text{ mA}$	—	356	474	mV	
	Load stability 1	ΔV_{RO1}	$V_{IN} = 6\text{ V}, I_{RO} = 0.1\text{ to }40\text{ mA}$	—	50	100	mV	
	Input stability 1	ΔV_{RO2}	$V_{IN} = 6\text{ to }16\text{ V}, I_{RO} = 30\text{ mA}$	—	5	20	mV	
	Output voltage temperature coefficient 1	$\frac{\Delta V_{RO}}{\Delta T_a \bullet V_{RO}}$	Ta = -40°C to +85°C	—	±100	—	ppm/°C	
	Output voltage 2	V_{OUT}	$V_{IN} = 6\text{ V}, I_{OUT} = 50\text{ mA}$	3.234	3.300	3.366	V	
	Dropout voltage 2	V_{drop2}	$V_{IN} = 6\text{ V}, I_{OUT} = 50\text{ mA}$	—	401	540	mV	
	Load stability 2	ΔV_{OUT1}	$V_{IN} = 6\text{ V}, I_{OUT} = 0.1\text{ to }60\text{ mA}$	—	50	100	mV	
	Input stability 2	ΔV_{OUT2}	$V_{IN} = 6\text{ to }16\text{ V}, I_{OUT} = 50\text{ mA}$	—	5	20	mV	
	Output voltage temperature coefficient 2	$\frac{\Delta V_{OUT}}{\Delta T_a \bullet V_{OUT}}$	Ta = -40°C to +85°C	—	±100	—	ppm/°C	
	Primary power input voltage	V_{IN}	—	—	—	16	V	
Voltage detector	CS detection voltage	$-V_{DET1}$	V_{IN} voltage detection	3.920	4.000	4.080	V	2
	CS release voltage	$+V_{DET1}$	—	4.030	4.129	4.228	V	
	RESET detection voltage	$-V_{DET2}$	V_{OUT} voltage detection	2.254	2.300	2.346	V	
	RESET release voltage	$+V_{DET2}$	—	2.362	2.420	2.478	V	
	PREEND detection voltage	$-V_{DET3}$	V_{BAT} voltage detection	2.450	2.500	2.550	V	
	PREEND release voltage	$+V_{DET3}$	—	2.576	2.640	2.703	V	
	Operating voltage	V_{opr}	V_{IN} or V_{BAT}	1.7	—	16	V	
	Detection voltage temperature coefficient	$\frac{\Delta - V_{DET1}}{\Delta T_a \bullet -V_{DET1}}$	Ta = -40°C to +85°C	—	±100	—	ppm/°C	
		$\frac{\Delta - V_{DET2}}{\Delta T_a \bullet -V_{DET2}}$	Ta = -40°C to +85°C	—	±100	—	ppm/°C	
		$\frac{\Delta - V_{DET3}}{\Delta T_a \bullet -V_{DET3}}$	Ta = -40°C to +85°C	—	±100	—	ppm/°C	
Sink current	I_{SINK}	$V_{DS} = 0.5\text{ V}, V_{IN} = V_{BAT} = 2.0\text{ V}$	RESET	1.50	2.30	—	mA	3
			PREEND	1.50	2.30	—	mA	
			CS	1.50	2.30	—	mA	
Leakage current	I_{LEAK}	$V_{DS} = 16\text{ V}, V_{IN} = 16\text{ V}$	—	—	0.1	μA		
Switch unit	Switch voltage	V_{SW1}	$V_{BAT} = 2.8\text{ V}, V_{IN}$ voltage detection	$+V_{DET1} \times 0.75$	$+V_{DET1} \times 0.77$	$+V_{DET1} \times 0.79$	V	4
	CS output inhibit voltage	V_{SW2}	$V_{BAT} = 3.0\text{ V}$ V_{OUT} voltage detection	$V_{OUT} \times 0.93$	$V_{OUT} \times 0.95$	$V_{OUT} \times 0.97$	V	5
	V_{BAT} switch leakage current	I_{LEAK}	$V_{IN} = 6\text{ V}, V_{BAT} = 0\text{ V}$	—	—	0.1	μA	6
	V_{BAT} switch resistance	R_{SW}	$V_{IN} = \text{Open}, V_{BAT} = 3.0\text{ V}, I_{OUT} = 10\text{ to }500\text{ }\mu\text{A}$	—	30	60	Ω	7
	Switch voltage temperature coefficient	$\frac{\Delta V_{SW1}}{\Delta T_a \bullet V_{SW1}}$	Ta = -40°C to +85°C	—	±100	—	ppm/°C	4
	CS output inhibit voltage temperature coefficient	$\frac{\Delta V_{SW2}}{\Delta T_a \bullet V_{SW2}}$	Ta = -40°C to +85°C	—	±100	—	ppm/°C	5
Total	Current consumption	I_{SS1}	$V_{IN} = 6\text{ V}, V_{BAT} = 3.0\text{ V}, \text{Unload}$	—	7	15	μA	8
		I_{BAT1}		—	0.26	0.50	μA	
	I_{BAT2}	$V_{IN} = \text{Open}, V_{BAT} = 3.0\text{ V}, \text{Unload}$	Ta = 25°C	—	1.0	2.1	μA	
		Ta = 85°C	—	—	3.5	μA		
Backup power supply input voltage	V_{BAT}	—	1.7	—	4.0	V	7	

Remark The number in the Test Circuit column corresponds to the circuit number in the "Test Circuit" section.

3. S-8424AACxx

Table 6 Electrical Characteristics

(Unless otherwise specified: Ta = 25°C)

	Parameter	Symbol	Conditions	Min.	Typ.	Max.	Unit	Test Circuit	
Voltage regulator	Output voltage 1	V _{RO}	V _{IN} = 3.6 V, I _{RO} = 15 mA	3.136	3.200	3.264	V	1	
	Dropout voltage 1	V _{drop1}	V _{IN} = 3.6 V, I _{RO} = 15 mA	—	181	243	mV		
	Load stability 1	ΔV _{RO1}	V _{IN} = 3.6 V, I _{RO} = 0.1 to 20 mA	—	50	100	mV		
	Input stability 1	ΔV _{RO2}	V _{IN} = 3.6 to 16 V, I _{RO} = 15 mA	—	5	20	mV		
	Output voltage temperature coefficient 1	$\frac{\Delta V_{RO}}{\Delta T_a \bullet V_{RO}}$	Ta = -40°C to +85°C	—	±100	—	ppm/°C		
	Output voltage 2	V _{OUT}	V _{IN} = 3.6 V, I _{OUT} = 15mA	3.136	3.200	3.264	V		
	Dropout voltage 2	V _{drop2}	V _{IN} = 3.6 V, I _{OUT} = 15 mA	—	123	167	mV		
	Load stability 2	ΔV _{OUT1}	V _{IN} = 3.6 V, I _{OUT} = 0.1 to 20 mA	—	50	100	mV		
	Input stability 2	ΔV _{OUT2}	V _{IN} = 3.6 to 16 V, I _{OUT} = 15 mA	—	5	20	mV		
	Output voltage temperature coefficient 2	$\frac{\Delta V_{OUT}}{\Delta T_a \bullet V_{OUT}}$	Ta = -40°C to +85°C	—	±100	—	ppm/°C		
	Primary power input voltage	V _{IN}	—	—	—	16	V		
Voltage detector	CS detection voltage	-V _{DET1}	V _{IN} voltage detection	3.234	3.300	3.366	V	2	
	CS release voltage	+V _{DET1}	—	3.319	3.401	3.482	V		
	RESET detection voltage	-V _{DET2}	V _{OUT} voltage detection	2.352	2.400	2.448	V		
	RESET release voltage	+V _{DET2}	—	2.467	2.528	2.589	V		
	PREEND detection voltage	-V _{DET3}	V _{BAT} voltage detection	2.548	2.600	2.652	V		
	PREEND release voltage	+V _{DET3}	—	2.682	2.748	2.814	V		
	Operating voltage	V _{opr}	V _{IN} or V _{BAT}	1.7	—	16	V		
	Detection voltage temperature coefficient	$\frac{\Delta - V_{DET}}{\Delta T_a \bullet -V_{DET}}$	Ta = -40°C to +85°C	—	±100	—	ppm/°C		
			Ta = -40°C to +85°C	—	±100	—	ppm/°C		
			Ta = -40°C to +85°C	—	±100	—	ppm/°C		
Sink current	I _{SINK}	V _{DS} = 0.5 V, V _{IN} = V _{BAT} = 2.0 V	RESET	1.50	2.30	—	mA	3	
			PREEND	1.50	2.30	—	mA		
			CS	1.50	2.30	—	mA		
Leakage current	I _{LEAK}	V _{DS} = 16 V, V _{IN} = 16 V	—	—	0.1	μA			
Switch unit	Switch voltage	V _{SW1}	V _{BAT} = 2.8 V, V _{IN} voltage detection	+V _{DET1} × 0.83	+V _{DET1} × 0.85	+V _{DET1} × 0.87	V	4	
	CS output inhibit voltage	V _{SW2}	V _{BAT} = 3.0 V, V _{OUT} voltage detection	V _{OUT} × 0.93	V _{OUT} × 0.95	V _{OUT} × 0.97	V	5	
	V _{BAT} switch leakage current	I _{LEAK}	V _{IN} = 3.6 V, V _{BAT} = 0 V	—	—	0.1	μA	6	
	V _{BAT} switch resistance	R _{SW}	V _{IN} = Open, V _{BAT} = 3.0 V, I _{OUT} = 10 to 500 μA	—	30	60	Ω	7	
	Switch voltage temperature coefficient	$\frac{\Delta V_{SW1}}{\Delta T_a \bullet V_{SW1}}$	Ta = -40°C to +85°C	—	±100	—	ppm/°C	4	
	CS output inhibit voltage temperature coefficient	$\frac{\Delta V_{SW2}}{\Delta T_a \bullet V_{SW2}}$	Ta = -40°C to +85°C	—	±100	—	ppm/°C	5	
Total	Current consumption	I _{SS1}	V _{IN} = 3.6 V, V _{BAT} = 3.0 V, Unload	—	7	15	μA	8	
				I _{BAT1}	—	0.26	0.50		μA
		I _{BAT2}	V _{IN} = Open, V _{BAT} = 3.0 V, Unload	Ta = 25°C	—	1.0	2.1		μA
				Ta = 85°C	—	—	3.5		μA
Backup power supply input voltage	V _{BAT}	—	1.7	—	4.0	V	7		

Remark The number in the Test Circuit column corresponds to the circuit number in the "Test Circuit" section.

4. S-8424AADxx

Table 7 Electrical Characteristics

(Unless otherwise specified: Ta = 25°C)

	Parameter	Symbol	Conditions	Min.	Typ.	Max.	Unit	Test Circuit
Voltage regulator	Output voltage 1	V _{RO}	V _{IN} = 6 V, I _{RO} = 30 mA	4.900	5.000	5.100	V	1
	Dropout voltage 1	V _{drop1}	V _{IN} = 6 V, I _{RO} = 30 mA	—	356	474	mV	
	Load stability 1	ΔV _{RO1}	V _{IN} = 6 V, I _{RO} = 0.1 to 40 mA	—	50	100	mV	
	Input stability 1	ΔV _{RO2}	V _{IN} = 6 to 16 V, I _{RO} = 30 mA	—	5	20	mV	
	Output voltage temperature coefficient 1	$\frac{\Delta V_{RO}}{\Delta T_a \bullet V_{RO}}$	Ta = -40°C to +85°C	—	±100	—	ppm/°C	
	Output voltage 2	V _{OUT}	V _{IN} = 6 V, I _{OUT} = 50 mA	4.900	5.000	5.100	V	
	Dropout voltage 2	V _{drop2}	V _{IN} = 6 V, I _{OUT} = 50 mA	—	401	540	mV	
	Load stability 2	ΔV _{OUT1}	V _{IN} = 6 V, I _{OUT} = 0.1 to 60 mA	—	50	100	mV	
	Input stability 2	ΔV _{OUT2}	V _{IN} = 6 to 16 V, I _{OUT} = 50 mA	—	5	20	mV	
	Output voltage temperature coefficient 2	$\frac{\Delta V_{OUT}}{\Delta T_a \bullet V_{OUT}}$	Ta = -40°C to +85°C	—	±100	—	ppm/°C	
	Primary power input voltage	V _{IN}	—	—	—	16	V	
	Voltage detector	CS detection voltage	-V _{DET1}	V _{IN} voltage detection	4.508	4.600	4.692	
CS release voltage		+V _{DET1}	—	4.639	4.753	4.867	V	
RESET detection voltage		-V _{DET2}	V _{OUT} voltage detection	2.254	2.300	2.346	V	
RESET release voltage		+V _{DET2}	—	2.362	2.420	2.478	V	
PREEND detection voltage		-V _{DET3}	V _{BAT} voltage detection	2.450	2.500	2.550	V	
PREEND release voltage		+V _{DET3}	—	2.576	2.640	2.703	V	
Operating voltage		V _{OPF}	V _{IN} or V _{BAT}	1.7	—	16	V	
Detection voltage temperature coefficient		$\frac{\Delta - V_{DET1}}{\Delta T_a \bullet -V_{DET1}}$	Ta = -40°C to +85°C	—	±100	—	ppm/°C	
		$\frac{\Delta - V_{DET2}}{\Delta T_a \bullet -V_{DET2}}$	Ta = -40°C to +85°C	—	±100	—	ppm/°C	
		$\frac{\Delta - V_{DET3}}{\Delta T_a \bullet -V_{DET3}}$	Ta = -40°C to +85°C	—	±100	—	ppm/°C	
Sink current	I _{SINK}	V _{DS} = 0.5 V, V _{IN} = V _{BAT} = 2.0 V	RESET	1.50	2.30	—	mA	3
			PREEND	1.50	2.30	—	mA	
			CS	1.50	2.30	—	mA	
Leakage current	I _{LEAK}	V _{DS} = 16 V, V _{IN} = 16 V	—	—	0.1	μA		
Switch unit	Switch voltage	V _{SW1}	V _{BAT} = 2.8 V, V _{IN} voltage detection	+V _{DET1} × 0.75	+V _{DET1} × 0.77	+V _{DET1} × 0.79	V	4
	CS output inhibit voltage	V _{SW2}	V _{BAT} = 3.0 V, V _{OUT} voltage detection	V _{OUT} × 0.93	V _{OUT} × 0.95	V _{OUT} × 0.97	V	5
	V _{BAT} switch leakage current	I _{LEAK}	V _{IN} = 6 V, V _{BAT} = 0 V	—	—	0.1	μA	6
	V _{BAT} switch resistance	R _{SW}	V _{IN} = Open, V _{BAT} = 3.0 V, I _{OUT} = 10 to 500 μA	—	30	60	Ω	7
	Switch voltage temperature coefficient	$\frac{\Delta V_{SW1}}{\Delta T_a \bullet V_{SW1}}$	Ta = -40°C to +85°C	—	±100	—	ppm/°C	4
	CS output inhibit voltage temperature coefficient	$\frac{\Delta V_{SW2}}{\Delta T_a \bullet V_{SW2}}$	Ta = -40°C to +85°C	—	±100	—	ppm/°C	5
Total	Current consumption	I _{SS1}	V _{IN} = 6 V, V _{BAT} = 3.0 V, Unload	—	7	15	μA	8
		I _{BAT1}		—	0.26	0.50	μA	
	I _{BAT2}	V _{IN} = Open, V _{BAT} = 3.0 V, Unload	Ta = 25°C	—	1.0	2.1	μA	
			Ta = 85°C	—	—	3.5	μA	
Backup power supply input voltage	V _{BAT}	—	1.7	—	4.0	V	7	

Remark The number in the Test Circuit column corresponds to the circuit number in the "Test Circuit" section.

5. S-8424AAExx

Table 8 Electrical Characteristics

(Unless otherwise specified: Ta = 25°C)

	Parameter	Symbol	Conditions	Min.	Typ.	Max.	Unit	Test Circuit
Voltage regulator	Output voltage 1	V _{RO}	V _{IN} = 6 V, I _{RO} = 30 mA	3.087	3.150	3.213	V	1
	Dropout voltage 1	V _{drop1}	V _{IN} = 6 V, I _{RO} = 30 mA	—	356	474	mV	
	Load stability 1	ΔV _{RO1}	V _{IN} = 6 V, I _{RO} = 0.1 to 30 mA	—	50	100	mV	
	Input stability 1	ΔV _{RO2}	V _{IN} = 6 to 16 V, I _{RO} = 30 mA	—	5	20	mV	
	Output voltage temperature coefficient 1	$\frac{\Delta V_{RO}}{\Delta T_a \bullet V_{RO}}$	Ta = -40°C to +85°C	—	±100	—	ppm/°C	
	Output voltage 2	V _{OUT}	V _{IN} = 6 V, I _{OUT} = 50 mA	3.087	3.150	3.213	V	
	Dropout voltage 2	V _{drop2}	V _{IN} = 6 V, I _{OUT} = 50 mA	—	401	540	mV	
	Load stability 2	ΔV _{OUT1}	V _{IN} = 6 V, I _{OUT} = 0.1 to 60 mA	—	50	100	mV	
	Input stability 2	ΔV _{OUT2}	V _{IN} = 6 to 16 V, I _{OUT} = 50 mA	—	5	20	mV	
	Output voltage temperature coefficient 2	$\frac{\Delta V_{OUT}}{\Delta T_a \bullet V_{OUT}}$	Ta = -40°C to +85°C	—	±100	—	ppm/°C	
	Primary power input voltage	V _{IN}	—	—	—	16	V	
Voltage detector	CS detection voltage	-V _{DET1}	V _{IN} voltage detection	4.116	4.200	4.284	V	2
	CS release voltage	+V _{DET1}	—	4.233	4.337	4.441	V	
	RESET detection voltage	-V _{DET2}	V _{OUT} voltage detection	2.254	2.300	2.346	V	
	RESET release voltage	+V _{DET2}	—	2.362	2.420	2.478	V	
	PREEND detection voltage	-V _{DET3}	V _{BAT} voltage detection	2.450	2.500	2.550	V	
	PREEND release voltage	+V _{DET3}	—	2.576	2.640	2.703	V	
	Operating voltage	V _{opr}	V _{IN} or V _{BAT}	1.7	—	16	V	
	Detection voltage temperature coefficient	$\frac{\Delta - V_{DET}}{\Delta T_a \bullet -V_{DET}}$	Ta = -40°C to +85°C	—	±100	—	ppm/°C	
			Ta = -40°C to +85°C	—	±100	—	ppm/°C	
			Ta = -40°C to +85°C	—	±100	—	ppm/°C	
Sink current	I _{SINK}	V _{DS} = 0.5 V, V _{IN} = V _{BAT} = 2.0 V	RESET	1.50	2.30	—	mA	3
			PREEND	1.50	2.30	—	mA	
			CS	1.50	2.30	—	mA	
Leakage current	I _{LEAK}	V _{DS} = 16 V, V _{IN} = 16 V	—	—	0.1	μA		
Switch unit	Switch voltage	V _{SW1}	V _{BAT} = 2.8 V, V _{IN} voltage detection	+V _{DET1} × 0.75	+V _{DET1} × 0.77	+V _{DET1} × 0.79	V	4
	CS output inhibit voltage	V _{SW2}	V _{BAT} = 3.0 V, V _{OUT} voltage detection	V _{OUT} × 0.93	V _{OUT} × 0.95	V _{OUT} × 0.97	V	5
	V _{BAT} switch leakage current	I _{LEAK}	V _{IN} = 6 V, V _{BAT} = 0 V	—	—	0.1	μA	6
	V _{BAT} switch resistance	R _{SW}	V _{IN} = Open, V _{BAT} = 3.0 V, I _{OUT} = 10 to 500 μA	—	30	60	Ω	7
	Switch voltage temperature coefficient	$\frac{\Delta V_{SW1}}{\Delta T_a \bullet V_{SW1}}$	Ta = -40°C to +85°C	—	±100	—	ppm/°C	4
	CS output inhibit voltage temperature coefficient	$\frac{\Delta V_{SW2}}{\Delta T_a \bullet V_{SW2}}$	Ta = -40°C to +85°C	—	±100	—	ppm/°C	5
Total	Current consumption	I _{SS1}	V _{IN} = 6 V, V _{BAT} = 3.0 V, Unload	—	7	15	μA	8
		I _{BAT1}		—	0.26	0.50	μA	
		I _{BAT2}	V _{IN} = Open, V _{BAT} = 3.0 V, Unload	Ta = 25°C	—	1.0	2.1	
				Ta = 85°C	—	—	3.5	μA
Backup power supply input voltage	V _{BAT}	—	1.7	—	4.0	V	7	

Remark The number in the Test Circuit column corresponds to the circuit number in the "Test Circuit" section.

6. S-8424AAFxx

Table 9 Electrical Characteristics

(Unless otherwise specified: Ta = 25°C)

	Parameter	Symbol	Conditions	Min.	Typ.	Max.	Unit	Test Circuit
Voltage regulator	Output voltage 1	V_{RO}	$V_{IN} = 6\text{ V}, I_{RO} = 30\text{ mA}$	3.136	3.200	3.264	V	1
	Dropout voltage 1	V_{drop1}	$V_{IN} = 6\text{ V}, I_{RO} = 30\text{ mA}$	—	356	474	mV	
	Load stability 1	ΔV_{RO1}	$V_{IN} = 6\text{ V}, I_{RO} = 0.1\text{ to }30\text{ mA}$	—	50	100	mV	
	Input stability 1	ΔV_{RO2}	$V_{IN} = 6\text{ to }16\text{ V}, I_{RO} = 30\text{ mA}$	—	5	20	mV	
	Output voltage temperature coefficient 1	$\frac{\Delta V_{RO}}{\Delta T_a \bullet V_{RO}}$	Ta = -40°C to +85°C	—	±100	—	ppm/°C	
	Output voltage 2	V_{OUT}	$V_{IN} = 6\text{ V}, I_{OUT} = 50\text{ mA}$	3.136	3.200	3.264	V	
	Dropout voltage 2	V_{drop2}	$V_{IN} = 6\text{ V}, I_{OUT} = 50\text{ mA}$	—	401	540	mV	
	Load stability 2	ΔV_{OUT1}	$V_{IN} = 6\text{ V}, I_{OUT} = 0.1\text{ to }50\text{ mA}$	—	50	100	mV	
	Input stability 2	ΔV_{OUT2}	$V_{IN} = 6\text{ to }16\text{ V}, I_{OUT} = 50\text{ mA}$	—	5	20	mV	
	Output voltage temperature coefficient 2	$\frac{\Delta V_{OUT}}{\Delta T_a \bullet V_{OUT}}$	Ta = -40°C to +85°C	—	±100	—	ppm/°C	
	Primary power input voltage	V_{IN}	—	—	—	16	V	
Voltage detector	CS detection voltage	$-V_{DET1}$	V_{IN} voltage detection	4.312	4.400	4.488	V	2
	CS release voltage	$+V_{DET1}$	—	4.436	4.545	4.654	V	
	RESET detection voltage	$-V_{DET2}$	V_{OUT} voltage detection	2.352	2.400	2.448	V	
	RESET release voltage	$+V_{DET2}$	—	2.467	2.528	2.589	V	
	PREEND detection voltage	$-V_{DET3}$	V_{BAT} voltage detection	2.548	2.600	2.652	V	
	PREEND release voltage	$+V_{DET3}$	—	2.682	2.748	2.814	V	
	Operating voltage	V_{opr}	V_{IN} or V_{BAT}	1.7	—	16	V	
	Detection voltage temperature coefficient	$\frac{\Delta - V_{DET1}}{\Delta T_a \bullet -V_{DET1}}$	Ta = -40°C to +85°C	—	±100	—	ppm/°C	
		$\frac{\Delta - V_{DET2}}{\Delta T_a \bullet -V_{DET2}}$	Ta = -40°C to +85°C	—	±100	—	ppm/°C	
		$\frac{\Delta - V_{DET3}}{\Delta T_a \bullet -V_{DET3}}$	Ta = -40°C to +85°C	—	±100	—	ppm/°C	
Sink current	I_{SINK}	$V_{DS} = 0.5\text{ V}, V_{IN} = V_{BAT} = 2.0\text{ V}$	RESET	1.50	2.30	—	mA	3
			PREEND	1.50	2.30	—	mA	
			CS	1.50	2.30	—	mA	
Leakage current	I_{LEAK}	$V_{DS} = 16\text{ V}, V_{IN} = 16\text{ V}$	—	—	0.1	μA		
Switch unit	Switch voltage	V_{SW1}	$V_{BAT} = 2.8\text{ V}, V_{IN}$ voltage detection	$+V_{DET1} \times 0.75$	$+V_{DET1} \times 0.77$	$+V_{DET1} \times 0.79$	V	4
	CS output inhibit voltage	V_{SW2}	$V_{BAT} = 3.0\text{ V}, V_{OUT}$ voltage detection	$V_{OUT} \times 0.93$	$V_{OUT} \times 0.95$	$V_{OUT} \times 0.97$	V	5
	V_{BAT} switch leakage current	I_{LEAK}	$V_{IN} = 6\text{ V}, V_{BAT} = 0\text{ V}$	—	—	0.1	μA	6
	V_{BAT} switch resistance	R_{SW}	$V_{IN} = \text{Open}, V_{BAT} = 3.0\text{ V}, I_{OUT} = 10\text{ to }500\text{ }\mu\text{A}$	—	30	60	Ω	7
	Switch voltage temperature coefficient	$\frac{\Delta V_{SW1}}{\Delta T_a \bullet V_{SW1}}$	Ta = -40°C to +85°C	—	±100	—	ppm/°C	4
	CS output inhibit voltage temperature coefficient	$\frac{\Delta V_{SW2}}{\Delta T_a \bullet V_{SW2}}$	Ta = -40°C to +85°C	—	±100	—	ppm/°C	5
Total	Current consumption	I_{SS1}	$V_{IN} = 6\text{ V}, V_{BAT} = 3.0\text{ V}, \text{Unload}$	—	7	15	μA	8
		I_{BAT1}		—	0.26	0.50	μA	
	I_{BAT2}	$V_{IN} = \text{Open}, V_{BAT} = 3.0\text{ V}, \text{Unload}$	Ta = 25°C	—	1.0	2.1	μA	
			Ta = 85°C	—	—	3.5	μA	
Backup power supply input voltage	V_{BAT}	—	1.7	—	4.0	V	7	

Remark The number in the Test Circuit column corresponds to the circuit number in the "Test Circuit" section.

7. S-8424AAGxx

Table 10 Electrical Characteristics

(Unless otherwise specified: Ta = 25°C)

	Parameter	Symbol	Conditions	Min.	Typ.	Max.	Unit	Test Circuit	
Voltage regulator	Output voltage 1	V _{RO}	V _{IN} = 6 V, I _{RO} = 30 mA	2.744	2.800	2.856	V	1	
	Dropout voltage 1	V _{drop1}	V _{IN} = 6 V, I _{RO} = 30 mA	—	356	474	mV		
	Load stability 1	ΔV _{RO1}	V _{IN} = 6 V, I _{RO} = 0.1 to 30 mA	—	50	100	mV		
	Input stability 1	ΔV _{RO2}	V _{IN} = 6 to 16 V, I _{RO} = 30 mA	—	5	20	mV		
	Output voltage temperature coefficient 1	$\frac{\Delta V_{RO}}{\Delta T_a \bullet V_{RO}}$	Ta = -40°C to +85°C	—	±100	—	ppm/°C		
	Output voltage 2	V _{OUT}	V _{IN} = 6 V, I _{OUT} = 50 mA	2.744	2.800	2.856	V		
	Dropout voltage 2	V _{drop2}	V _{IN} = 6 V, I _{OUT} = 50 mA	—	401	540	mV		
	Load stability 2	ΔV _{OUT1}	V _{IN} = 6 V, I _{OUT} = 0.1 to 50 mA	—	50	100	mV		
	Input stability 2	ΔV _{OUT2}	V _{IN} = 6 to 16 V, I _{OUT} = 50 mA	—	5	20	mV		
	Output voltage temperature coefficient 2	$\frac{\Delta V_{OUT}}{\Delta T_a \bullet V_{OUT}}$	Ta = -40°C to +85°C	—	±100	—	ppm/°C		
	Primary power input voltage	V _{IN}	—	—	—	16	V		
Voltage detector	CS detection voltage	-V _{DET1}	V _{IN} voltage detection	4.312	4.400	4.488	V	2	
	CS release voltage	+V _{DET1}		4.436	4.545	4.654	V		
	detection voltage	-V _{DET2}	V _{OUT} voltage detection	2.352	2.400	2.448	V		
	RESET release voltage	+V _{DET2}		2.467	2.528	2.589	V		
	PREEND detection voltage	-V _{DET3}	V _{BAT} voltage detection	2.548	2.600	2.652	V		
	PREEND release voltage	+V _{DET3}		2.682	2.748	2.814	V		
	Operating voltage	V _{opr}	V _{IN} or V _{BAT}	1.7	—	16	V		
	Detection voltage temperature coefficient	$\frac{\Delta - V_{DET1}}{\Delta T_a \bullet -V_{DET1}}$	Ta = -40°C to +85°C	—	±100	—	ppm/°C		
			$\frac{\Delta - V_{DET2}}{\Delta T_a \bullet -V_{DET2}}$	Ta = -40°C to +85°C	—	±100	—		ppm/°C
			$\frac{\Delta - V_{DET3}}{\Delta T_a \bullet -V_{DET3}}$	Ta = -40°C to +85°C	—	±100	—		ppm/°C
Sink current	I _{SINK}	V _{DS} = 0.5 V, V _{IN} = V _{BAT} = 2.0 V	RESET	1.50	2.30	—	mA	3	
			PREEND	1.50	2.30	—	mA		
			CS	1.50	2.30	—	mA		
Leakage current	I _{LEAK}	V _{DS} = 16 V, V _{IN} = 16 V	—	—	0.1	μA			
Switch unit	Switch voltage	V _{SW1}	V _{BAT} = 2.8 V, V _{IN} voltage detection	+V _{DET1} × 0.75	+V _{DET1} × 0.77	+V _{DET1} × 0.79	V	4	
	CS output inhibit voltage	V _{SW2}	V _{BAT} = 3.0 V, V _{OUT} voltage detection	V _{OUT} × 0.93	V _{OUT} × 0.95	V _{OUT} × 0.97	V	5	
	V _{BAT} switch leakage current	I _{LEAK}	V _{IN} = 6 V, V _{BAT} = 0 V	—	—	0.1	μA	6	
	V _{BAT} switch resistance	R _{SW}	V _{IN} = Open, V _{BAT} = 3.0 V, I _{OUT} = 10 to 500 μA	—	30	60	Ω	7	
	Switch voltage temperature coefficient	$\frac{\Delta V_{SW1}}{\Delta T_a \bullet V_{SW1}}$	Ta = -40°C to +85°C	—	±100	—	ppm/°C	4	
	CS output inhibit voltage temperature coefficient	$\frac{\Delta V_{SW2}}{\Delta T_a \bullet V_{SW2}}$	Ta = -40°C to +85°C	—	±100	—	ppm/°C	5	
Total	Current consumption	I _{SS1}	V _{IN} = 6 V, V _{BAT} = 3.0 V, Unload	—	7	15	μA	8	
				I _{BAT1}	—	0.26	0.50		μA
		I _{BAT2}	V _{IN} = Open, V _{BAT} = 3.0 V, Unload	Ta = 25°C	—	1.0	2.1		μA
				Ta = 85°C	—	—	3.5		μA
Backup power supply input voltage	V _{BAT}	—	1.7	—	4.0	V	7		

Remark The number in the Test Circuit column corresponds to the circuit number in the "Test Circuit" section.

8. S-8424AAHxx

Table 11 Electrical Characteristics

(Unless otherwise specified: Ta = 25°C)

	Parameter	Symbol	Conditions	Min.	Typ.	Max.	Unit	Test Circuit
Voltage regulator	Output voltage 1	V _{RO}	V _{IN} = 6 V, I _{RO} = 30 mA	4.900	5.000	5.100	V	1
	Dropout voltage 1	V _{drop1}	V _{IN} = 6 V, I _{RO} = 30 mA	—	356	474	mV	
	Load stability 1	ΔV _{RO1}	V _{IN} = 6 V, I _{RO} = 0.1 to 40 mA	—	50	100	mV	
	Input stability 1	ΔV _{RO2}	V _{IN} = 6 to 16 V, I _{RO} = 30 mA	—	5	20	mV	
	Output voltage temperature coefficient 1	$\frac{\Delta V_{RO}}{\Delta T_a \bullet V_{RO}}$	Ta = -40°C to +85°C	—	±100	—	ppm/°C	
	Output voltage 2	V _{OUT}	V _{IN} = 6 V, I _{OUT} = 50 mA	4.900	5.000	5.100	V	
	Dropout voltage 2	V _{drop2}	V _{IN} = 6 V, I _{OUT} = 50 mA	—	401	540	mV	
	Load stability 2	ΔV _{OUT1}	V _{IN} = 6 V, I _{OUT} = 0.1 to 60 mA	—	50	100	mV	
	Input stability 2	ΔV _{OUT2}	V _{IN} = 6 to 16 V, I _{OUT} = 50 mA	—	5	20	mV	
	Output voltage temperature coefficient 2	$\frac{\Delta V_{OUT}}{\Delta T_a \bullet V_{OUT}}$	Ta = -40°C to +85°C	—	±100	—	ppm/°C	
	Primary power input voltage	V _{IN}	—	—	—	16	V	
Voltage detector	CS detection voltage	-V _{DET1}	V _{IN} voltage detection	4.508	4.600	4.692	V	2
	CS release voltage	+V _{DET1}		4.639	4.753	4.867	V	
	RESET detection voltage	-V _{DET2}	V _{OUT} voltage detection	2.499	2.550	2.601	V	
	RESET release voltage	+V _{DET2}		2.625	2.690	2.754	V	
	PREEND detection voltage	-V _{DET3}	V _{BAT} voltage detection	2.646	2.700	2.754	V	
	PREEND release voltage	+V _{DET3}		2.787	2.856	2.924	V	
	Operating voltage	V _{opr}	V _{IN} or V _{BAT}	1.7	—	16	V	
	Detection voltage temperature coefficient	$\frac{\Delta - V_{DET1}}{\Delta T_a \bullet -V_{DET1}}$	Ta = -40°C to +85°C	—	±100	—	ppm/°C	
		$\frac{\Delta - V_{DET2}}{\Delta T_a \bullet -V_{DET2}}$	Ta = -40°C to +85°C	—	±100	—	ppm/°C	
		$\frac{\Delta - V_{DET3}}{\Delta T_a \bullet -V_{DET3}}$	Ta = -40°C to +85°C	—	±100	—	ppm/°C	
Sink current	I _{SINK}	V _{DS} = 0.5 V, V _{IN} = V _{BAT} = 2.0 V	RESET	1.50	2.30	—	mA	3
			PREEND	1.50	2.30	—	mA	
			CS	1.50	2.30	—	mA	
Leakage current	I _{LEAK}	V _{DS} = 16 V, V _{IN} = 16 V	—	—	0.1	μA		
Switch unit	Switch voltage	V _{SW1}	V _{BAT} = 2.8 V, V _{IN} voltage detection	+V _{DET1} × 0.75	+V _{DET1} × 0.77	+V _{DET1} × 0.79	V	4
	CS output inhibit voltage	V _{SW2}	V _{BAT} = 3.0 V, V _{OUT} voltage detection	V _{OUT} × 0.93	V _{OUT} × 0.95	V _{OUT} × 0.97	V	5
	V _{BAT} switch leakage current	I _{LEAK}	V _{IN} = 6 V, V _{BAT} = 0 V	—	—	0.1	μA	6
	V _{BAT} switch resistance	R _{SW}	V _{IN} = Open, V _{BAT} = 3.0 V, I _{OUT} = 10 to 500 μA	—	30	60	Ω	7
	Switch voltage temperature coefficient	$\frac{\Delta V_{SW1}}{\Delta T_a \bullet V_{SW1}}$	Ta = -40°C to +85°C	—	±100	—	ppm/°C	4
	CS output inhibit voltage temperature coefficient	$\frac{\Delta V_{SW2}}{\Delta T_a \bullet V_{SW2}}$	Ta = -40°C to +85°C	—	±100	—	ppm/°C	5
Total	Current consumption	I _{SS1}	V _{IN} = 6 V, V _{BAT} = 3.0 V, Unload	—	7	15	μA	8
		I _{BAT1}		—	0.26	0.50	μA	
	I _{BAT2}	V _{IN} = Open, V _{BAT} = 3.0 V, Unload	Ta = 25°C	—	1.0	2.1	μA	
			Ta = 85°C	—	—	3.5	μA	
Backup power supply input voltage	V _{BAT}	—	1.7	—	4.0	V	7	

Remark The number in the Test Circuit column corresponds to the circuit number in the "Test Circuit" section.

9. S-8424AAJFxx

Table 12 Electrical Characteristics

(Unless otherwise specified: Ta = 25°C)

	Parameter	Symbol	Conditions	Min.	Typ.	Max.	Unit	Test Circuit	
Voltage regulator	Output voltage 1	V _{RO}	V _{IN} = 6 V, I _{RO} = 10 mA	3.038	3.100	3.162	V	1	
	Dropout voltage 1	V _{drop1}	V _{IN} = 6 V, I _{RO} = 10 mA	—	123	167	mV		
	Load stability 1	ΔV _{RO1}	V _{IN} = 6 V, I _{RO} = 0.1 to 15 mA	—	50	100	mV		
	Input stability 1	ΔV _{RO2}	V _{IN} = 6 to 16 V, I _{RO} = 10 mA	—	5	20	mV		
	Output voltage temperature coefficient 1	$\frac{\Delta V_{RO}}{\Delta T_a \bullet V_{RO}}$	Ta = -40°C to +85°C	—	±100	—	ppm/°C		
	Output voltage 2	V _{OUT}	V _{IN} = 6 V, I _{OUT} = 50 mA	3.038	3.100	3.162	V		
	Dropout voltage 2	V _{drop2}	V _{IN} = 6 V, I _{OUT} = 50 mA	—	401	540	mV		
	Load stability 2	ΔV _{OUT1}	V _{IN} = 6 V, I _{OUT} = 0.1 to 60 mA	—	50	100	mV		
	Input stability 2	ΔV _{OUT2}	V _{IN} = 6 to 16 V, I _{OUT} = 50 mA	—	5	20	mV		
	Output voltage temperature coefficient 2	$\frac{\Delta V_{OUT}}{\Delta T_a \bullet V_{OUT}}$	Ta = -40°C to +85°C	—	±100	—	ppm/°C		
	Primary power input voltage	V _{IN}	—	—	—	16	V		
Voltage detector	CS detection voltage	-V _{DET1}	V _{IN} voltage detection	4.312	4.400	4.488	V	2	
	CS release voltage	+V _{DET1}	—	4.436	4.545	4.654	V		
	RESET detection voltage	-V _{DET2}	V _{OUT} voltage detection	2.156	2.200	2.244	V		
	RESET release voltage	+V _{DET2}	—	2.256	2.312	2.367	V		
	PREEND detection voltage	-V _{DET3}	V _{BAT} voltage detection	2.548	2.600	2.652	V		
	PREEND release voltage	+V _{DET3}	—	2.682	2.748	2.814	V		
	Operating voltage	V _{opr}	V _{IN} or V _{BAT}	1.7	—	16	V		
	Detection voltage temperature coefficient	$\frac{\Delta - V_{DET}}{\Delta T_a \bullet -V_{DET}}$	Ta = -40°C to +85°C	—	±100	—	ppm/°C		
			Ta = -40°C to +85°C	—	±100	—	ppm/°C		
			Ta = -40°C to +85°C	—	±100	—	ppm/°C		
Sink current	I _{SINK}	V _{DS} = 0.5 V, V _{IN} = V _{BAT} = 2.0 V	RESET	1.50	2.30	—	mA	3	
			PREEND	1.50	2.30	—	mA		
			CS	1.50	2.30	—	mA		
Leakage current	I _{LEAK}	V _{DS} = 16 V, V _{IN} = 16 V	—	—	0.1	μA			
Switch unit	Switch voltage	V _{SW1}	V _{BAT} = 2.8 V, V _{IN} voltage detection	+V _{DET1} × 0.75	+V _{DET1} × 0.77	+V _{DET1} × 0.79	V	4	
	CS output inhibit voltage	V _{SW2}	V _{BAT} = 3.0 V, V _{OUT} voltage detection	V _{OUT} × 0.93	V _{OUT} × 0.95	V _{OUT} × 0.97	V	5	
	V _{BAT} switch leakage current	I _{LEAK}	V _{IN} = 6 V, V _{BAT} = 0 V	—	—	0.1	μA	6	
	V _{BAT} switch resistance	R _{SW}	V _{IN} = Open, V _{BAT} = 3.0 V, I _{OUT} = 10 to 500 μA	—	30	60	Ω	7	
	Switch voltage temperature coefficient	$\frac{\Delta V_{SW1}}{\Delta T_a \bullet V_{SW1}}$	Ta = -40°C to +85°C	—	±100	—	ppm/°C	4	
	CS output inhibit voltage temperature coefficient	$\frac{\Delta V_{SW2}}{\Delta T_a \bullet V_{SW2}}$	Ta = -40°C to +85°C	—	±100	—	ppm/°C	5	
	Total	Current consumption	I _{SS1}	V _{IN} = 6 V, V _{BAT} = 3.0 V, Unload	—	7	15	μA	8
I _{BAT1}					—	0.26	0.50	μA	
I _{BAT2}			V _{IN} = Open, V _{BAT} = 3.0 V, Unload	Ta = 25°C	—	1.0	2.1	μA	
				Ta = 85°C	—	—	3.5	μA	
Backup power supply input voltage	V _{BAT}	—	1.7	—	4.0	V	7		

Remark The number in the Test Circuit column corresponds to the circuit number in the "Test Circuit" section.

10. S-8424AAKxx

Table 13 Electrical Characteristics

(Unless otherwise specified: Ta = 25°C)

	Parameter	Symbol	Conditions	Min.	Typ.	Max.	Unit	Test Circuit
Voltage regulator	Output voltage 1	V _{RO}	V _{IN} = 6 V, I _{RO} = 10 mA	3.136	3.200	3.264	V	1
	Dropout voltage 1	V _{drop1}	V _{IN} = 6 V, I _{RO} = 10 mA	—	123	167	mV	
	Load stability 1	ΔV _{RO1}	V _{IN} = 6 V, I _{RO} = 0.1 to 15 mA	—	50	100	mV	
	Input stability 1	ΔV _{RO2}	V _{IN} = 6 to 16 V, I _{RO} = 10 mA	—	5	20	mV	
	Output voltage temperature coefficient 1	$\frac{\Delta V_{RO}}{\Delta T_a \bullet V_{RO}}$	Ta = -40°C to +85°C	—	±100	—	ppm/°C	
	Output voltage 2	V _{OUT}	V _{IN} = 6 V, I _{OUT} = 50 mA	3.136	3.200	3.264	V	
	Dropout voltage 2	V _{drop2}	V _{IN} = 6 V, I _{OUT} = 50 mA	—	401	540	mV	
	Load stability 2	ΔV _{OUT1}	V _{IN} = 6 V, I _{OUT} = 0.1 to 60 mA	—	50	100	mV	
	Input stability 2	ΔV _{OUT2}	V _{IN} = 6 to 16 V, I _{OUT} = 50 mA	—	5	20	mV	
	Output voltage temperature coefficient 2	$\frac{\Delta V_{OUT}}{\Delta T_a \bullet V_{OUT}}$	Ta = -40°C to +85°C	—	±100	—	ppm/°C	
	Primary power input voltage	V _{IN}	—	—	—	16	V	
	Voltage detector	CS detection voltage	-V _{DET1}	V _{IN} voltage detection	4.508	4.600	4.692	
CS release voltage		+V _{DET1}	—	4.639	4.753	4.867	V	
RESET detection voltage		-V _{DET2}	V _{OUT} voltage detection	2.352	2.400	2.448	V	
RESET release voltage		+V _{DET2}	—	2.467	2.528	2.589	V	
PREEND detection voltage		-V _{DET3}	V _{BAT} voltage detection	2.548	2.600	2.652	V	
PREEND release voltage		+V _{DET3}	—	2.682	2.748	2.814	V	
Operating voltage		V _{OPF}	V _{IN} or V _{BAT}	1.7	—	16	V	
Detection voltage temperature coefficient		$\frac{\Delta - V_{DET1}}{\Delta T_a \bullet -V_{DET1}}$	Ta = -40°C to +85°C	—	±100	—	ppm/°C	
		$\frac{\Delta - V_{DET2}}{\Delta T_a \bullet -V_{DET2}}$	Ta = -40°C to +85°C	—	±100	—	ppm/°C	
		$\frac{\Delta - V_{DET3}}{\Delta T_a \bullet -V_{DET3}}$	Ta = -40°C to +85°C	—	±100	—	ppm/°C	
Sink current	I _{SINK}	V _{DS} = 0.5 V, V _{IN} = V _{BAT} = 2.0 V	RESET	1.50	2.30	—	mA	3
			PREEND	1.50	2.30	—	mA	
			CS	1.50	2.30	—	mA	
Leakage current	I _{LEAK}	V _{DS} = 16 V, V _{IN} = 16 V	—	—	0.1	μA		
Switch unit	Switch voltage	V _{SW1}	V _{BAT} = 2.8 V, V _{IN} voltage detection	+V _{DET1} × 0.75	+V _{DET1} × 0.77	+V _{DET1} × 0.79	V	4
	CS output inhibit voltage	V _{SW2}	V _{BAT} = 3.0 V, V _{OUT} voltage detection	V _{OUT} × 0.93	V _{OUT} × 0.95	V _{OUT} × 0.97	V	5
	V _{BAT} switch leakage current	I _{LEAK}	V _{IN} = 6 V, V _{BAT} = 0 V	—	—	0.1	μA	6
	V _{BAT} switch resistance	R _{SW}	V _{IN} = Open, V _{BAT} = 3.0 V, I _{OUT} = 10 to 500 μA	—	30	60	Ω	7
	Switch voltage temperature coefficient	$\frac{\Delta V_{SW1}}{\Delta T_a \bullet V_{SW1}}$	Ta = -40°C to +85°C	—	±100	—	ppm/°C	4
	CS output inhibit voltage temperature coefficient	$\frac{\Delta V_{SW2}}{\Delta T_a \bullet V_{SW2}}$	Ta = -40°C to +85°C	—	±100	—	ppm/°C	5
Total	Current consumption	I _{SS1}	V _{IN} = 6 V, V _{BAT} = 3.0 V, Unload	—	7	15	μA	8
		I _{BAT1}		—	0.26	0.50	μA	
	I _{BAT2}	V _{IN} = Open, V _{BAT} = 3.0 V, Unload	Ta = 25°C	—	1.0	2.1	μA	
			Ta = 85°C	—	—	3.5	μA	
Backup power supply input voltage	V _{BAT}	—	1.7	—	4.0	V	7	

Remark The number in the Test Circuit column corresponds to the circuit number in the "Test Circuit" section.

■ Test Circuit

1.

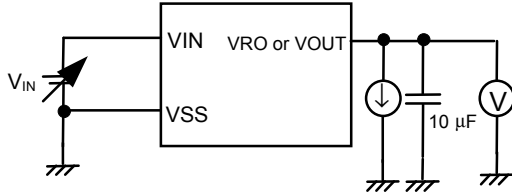

2.

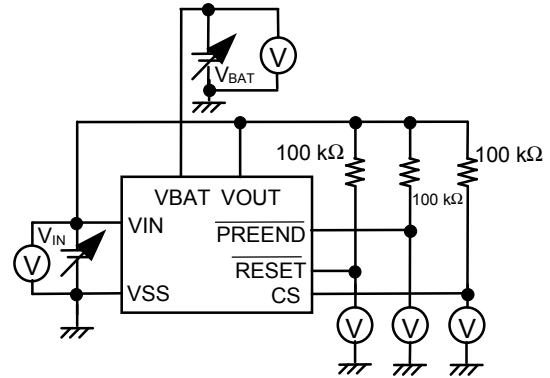

To measure V_{DET3} , apply 6 V to V_{IN} .

3.

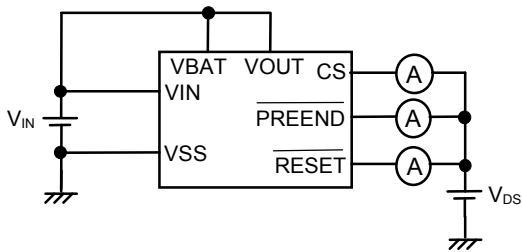

4.

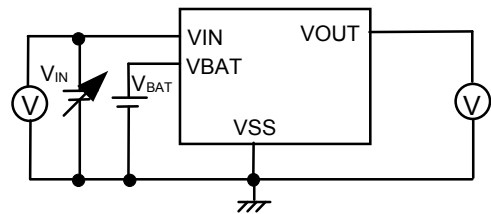

Measure the value after applying 6 V to V_{IN} .

5.

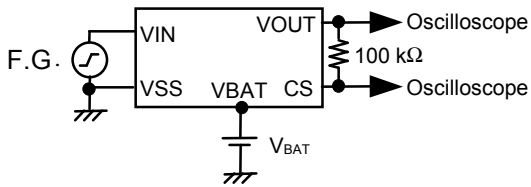

6.

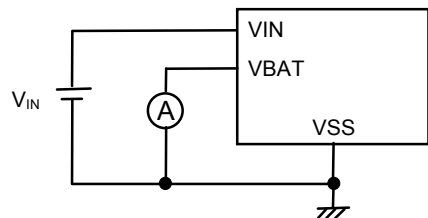

7.

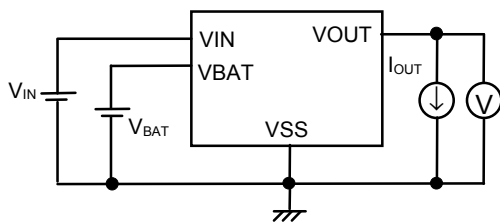

Leave open and measure the value after applying 6 V to V_{IN} .

8.

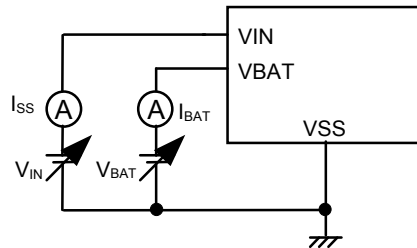

To measure I_{BAT2} , apply 6 V to V_{IN} and then leave V_{IN} open and measure I_{BAT} .

Figure 5 Test Circuit

■ Operation Timing Chart

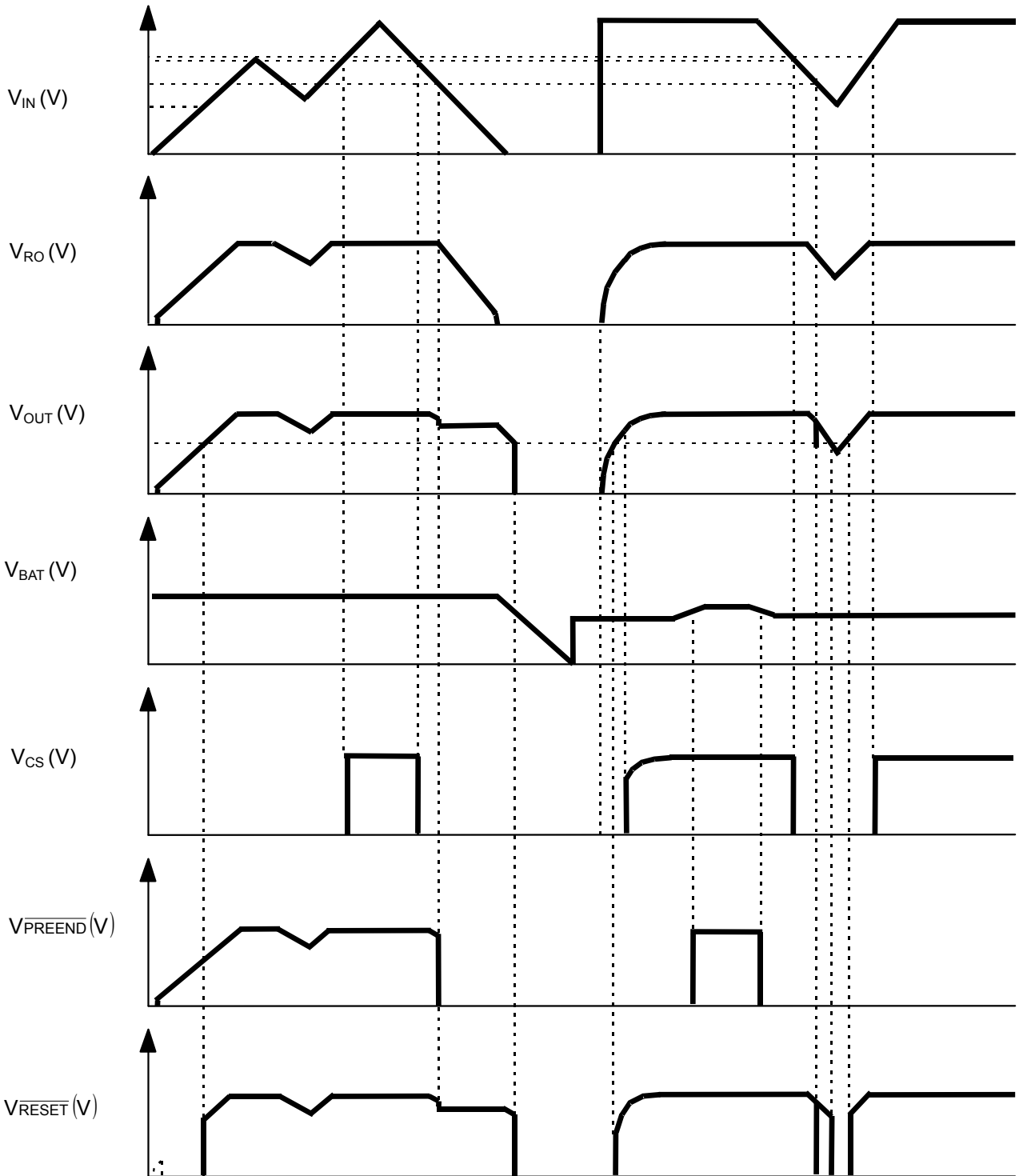

Remark CS, \overline{PREEND} and \overline{RESET} are pulled up to V_{OUT} . Y-axis is an arbitrary scale.

Figure 6 Operation Timing Chart

■ Operation

The internal configuration of the S-8424A Series is as follows.

- Voltage regulator 1, which stabilizes input voltage (V_{IN}) and outputs it to V_{RO}
- Voltage regulator 2, which stabilizes input voltage (V_{IN}) and outputs it to V_{OUT}
- CS voltage detector, which monitors input voltage (V_{IN})
- $\overline{\text{PREEND}}$ voltage detector, which monitors output voltage (V_{BAT})
- $\overline{\text{RESET}}$ voltage detector, which monitors output voltage (V_{OUT})
- Switch unit

The functions and operations of the above-listed elements are described below.

1. Voltage Regulators

The S-8424A Series features on-chip voltage regulators with a small dropout voltage. The voltage of the V_{RO} and V_{OUT} pins (the output pins of the voltage regulator) can separately be selected for the output voltage in 0.1 V steps between the range of 2.3 to 5.4 V.

[Dropout voltage V_{drop1} , V_{drop2}]

Assume that the voltage output from the V_{RO} pin is $V_{RO(E)}$ under the conditions of output voltage 1 described in the electrical characteristics table. V_{IN1} is defined as the input voltage at which output voltage from the V_{RO} pin becomes 98% of $V_{RO(E)}$ when the input voltage V_{IN} is decreased. Then, the dropout voltage V_{drop1} is calculated by the following expression.

$$V_{\text{drop1}} = V_{IN1} - V_{RO(E)} \times 0.98$$

Similarly, assume that the voltage of the V_{OUT} pin is $V_{OUT(E)}$ under the conditions of output voltage 2 described in the electrical characteristics table. V_{IN2} is defined as the input voltage at which the output voltage from the V_{OUT} pin becomes 98% of $V_{OUT(E)}$. Then, the dropout voltage V_{drop2} is calculated by the following expression.

$$V_{\text{drop2}} = V_{IN2} - V_{OUT(E)} \times 0.98$$

2. Voltage Detector

The S-8424A Series incorporates three high-precision, low power consuming voltage detectors with hysteresis characteristics. The power of the CS voltage detector is supplied from the V_{IN} and V_{BAT} pins. Therefore, the output is stable as long as the primary or backup power supplies are within the operating voltage range (1.7 to 16 V). All outputs are Nch open-drain, and need pull-up resistors of about 100 k Ω .

2.1 CS Voltage Detector

The CS voltage detector monitors the input voltage V_{IN} (V_{IN} pin voltage). The detection voltage can be selected from between 2.4 and 5.3 V in 0.1 V steps. The result of detection is output at the CS pin: "Low" for lower voltage than the detection level and "High" for higher voltage than the release level (however, when the V_{OUT} pin voltage is the CS output inhibit voltage (V_{SW2}), a low level is output).

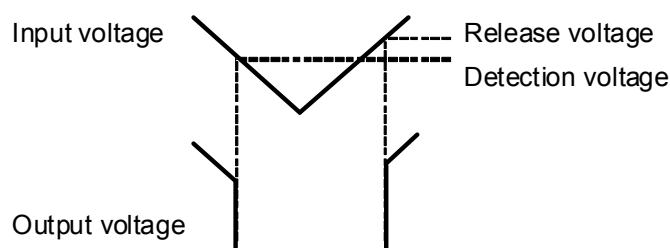

Figure 7 Definition of Detection and Release Voltages

2.2 $\overline{\text{PREEND}}$ Voltage Detector

The $\overline{\text{PREEND}}$ voltage detector monitors the input voltage V_{BAT} (VBAT pin voltage). The detection voltage can be selected from between 1.7 V and 3.4 V in 0.1 V steps. A higher voltage can also be selected keeping a constant difference with the $\overline{\text{RESET}}$ voltage. This function enables the warning that the backup battery is running out. The detection result is output to the $\overline{\text{PREEND}}$ pin: “Low” for lower voltages than the detection voltage and “High” for higher voltages than the release voltage. The power supply of the $\overline{\text{PREEND}}$ voltage detector is supplied from the VIN pin. The output is valid only when the voltage is supplied from the VIN pin to the VOUT pin ($V_{\text{IN}} \geq V_{\text{SW1}}$). The output is the low level when the voltage is supplied from the VBAT pin to the VOUT pin ($V_{\text{IN}} < V_{\text{SW1}}$).

2.3 $\overline{\text{RESET}}$ Voltage Detector

The $\overline{\text{RESET}}$ voltage detector monitors the output voltage V_{OUT} (VOUT pin voltage). The detection voltage can be selected from between 1.7 V and 3.4 V in 0.1 V steps. The result of detection is output at the $\overline{\text{RESET}}$ pin: “Low” for lower voltages than the detection level and “High” for higher voltages than the release level. $\overline{\text{RESET}}$ outputs the normal logic if the VOUT pin voltage is 1.0 V or more.

Caution The $\overline{\text{PREEND}}$ and $\overline{\text{RESET}}$ voltage detectors use the different pins, respectively. Practically, the current is taken from the VBAT side, and consider the I/O voltage difference (V_{dif}) of M1 when M1 is ON.

3. Switch Unit

The switch unit consists of the V_{SW1} and V_{SW2} detectors, a switch controller, voltage regulator 2, and switch transistor M1 (Refer to “Figure 8 Switch Unit”).

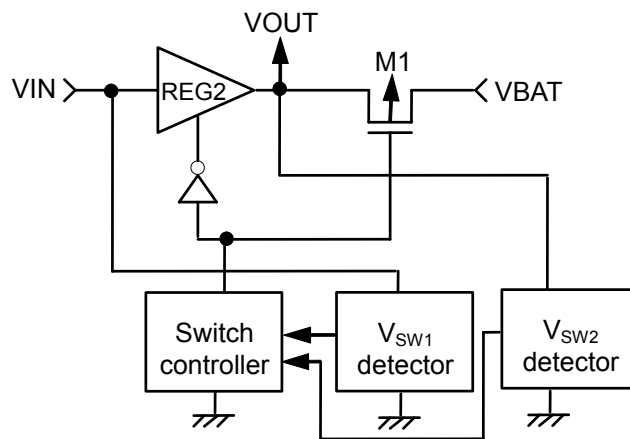

Figure 8 Switch Unit

3.1 V_{SW1} Detector

The V_{SW1} detector monitors the power supply voltage V_{IN} and sends the results of detection to the switch controller. The detection voltage (V_{SW1}) can be set to $77 \pm 2\%$ or $85 \pm 2\%$ of the CS release voltage $+V_{\text{DET1}}$.

3.2 V_{SW2} Detector

The V_{SW2} detector monitors the VOUT pin voltage and keeps the CS release voltage output low until the VOUT pin voltage rises to V_{SW2} voltage. The CS pin output then changes from low to high if the VIN pin voltage is more than the CS release voltage (+V_{DET1}) when the VOUT pin voltage rises to 95 ±2% of the output voltage of voltage regulator 2 (V_{OUT}). The CS pin output changes from high to low regardless of the V_{SW2} voltage when the VIN pin voltage drops to less than the CS detection voltage (–V_{DET1}). The CS pin output remains high if the VIN pin voltage stays higher than the CS detection voltage (–V_{DET1}) when the VOUT pin voltage drops to less than the V_{SW2} voltage due to an undershoot.

3.3 Switch Controller

The switch controller controls voltage regulator 2 and switch transistor M1. There are two statuses corresponding to the power supply voltage V_{IN} (or power supply voltage V_{BAT}) sequence: a special sequence status and a normal sequence status. When the power supply voltage V_{IN} rises and becomes equal to or exceeds the CS release voltage (+V_{DET1}), the normal sequence status is entered, but until then the special sequence status is maintained.

(1) Special sequence status

The switch controller sets voltage regulator 2 ON and switch transistor M1 OFF from the initial status until the primary power supply voltage V_{IN} is connected and reaches more than the CS release voltage (+V_{DET1}) in order to prevent consumption of the backup power supply regardless of the V_{SW1} detector status. This status is called the special sequence status.

(2) Normal sequence status

The switch controller enters the normal sequence status from the special sequence status once the primary power supply voltage V_{IN} reaches more than the CS release voltage (+V_{DET1}).

Once the normal sequence is entered, the switch controller switches voltage regulator 2 and switch transistor M1 ON/OFF as shown in **Table 14** according to the power supply voltage V_{IN}. The time required for voltage regulator 2 to be switched from OFF to ON is a few hundred μs at most. During this interval, voltage regulator 2 and switch transistor M1 may both switch OFF and the VOUT pin voltage may drop. To prevent this, connect a capacitor of 10 μF or more to the VOUT pin.

When the VOUT pin voltage becomes lower than the $\overline{\text{RESET}}$ detection voltage, the status returns to the special sequence status.

Table 14 ON/OFF Switching of Voltage Regulator 2 and Switch Transistor M1 According to Power Supply Voltage (V_{IN})

Power Supply Voltage (V _{IN})	Voltage Regulator 2	Switch Transistor M1	VOUT Pin Voltage
V _{IN} > V _{SW1}	ON	OFF	V _{OUT}
V _{IN} < V _{SW1}	OFF	ON	V _{BAT} – V _{dif}

3.4 Switch Transistor M1

Voltage regulator 2 is also used to switch from VIN pin to VOUT pin. Therefore, no reverse current flows from VOUT pin to VIN pin when voltage regulator 2 is OFF. The output voltage of voltage regulator 2 can be selected from between 2.3 V and 5.4 V in 0.1 V steps.

The on-resistance of switch transistor M1 is 60 Ω or lower ($I_{OUT} = 10$ to 500 μA).

Therefore, when M1 is switched ON and VOUT pin is connected to VBAT pin, the voltage drop (V_{dif}) caused by M1 is $60 \times I_{OUT}$ (output current) at maximum., and $V_{BAT} - V_{dif}$ (max.) is output to the VOUT pin at minimum.

When voltage regulator 2 is ON and M1 is OFF, the leakage current of M1 is kept below 0.1 μA max. ($V_{IN} = 6$ V, $T_a = 25^\circ\text{C}$) with the VBAT pin grounded (VSS pin).

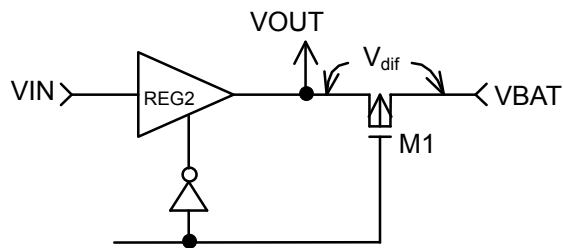

Figure 9 Definition of V_{dif}

■ Transient Response

1. Line Transient Response Against Input Voltage Variation

The input voltage variation differs depending on whether the power supply input (0 V to 10 V square wave) is applied or the power supply variation (6 V and 10 V square waves) is applied. This section describes the ringing waveforms and parameter dependency of each type. The test circuit is shown for reference.

Power supply application: 0 V to 10 V Square wave

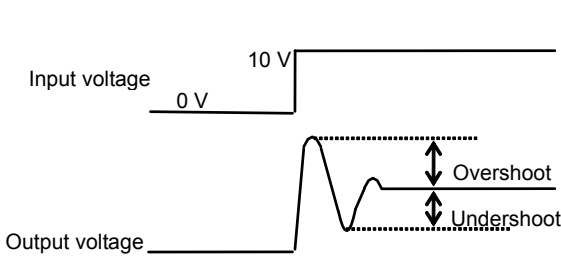

Figure 10 Power Supply Application: 0 V to 10 V Square Wave

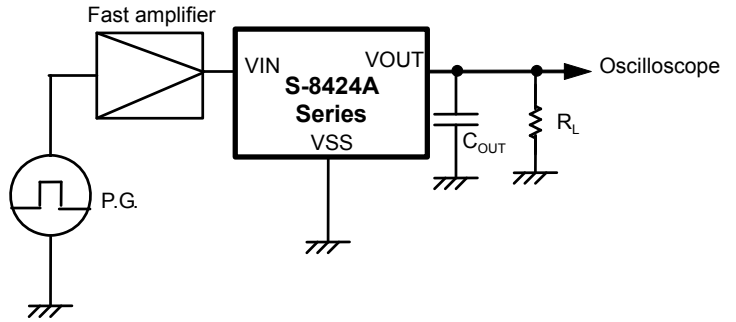

Figure 11 Test Circuit

Power Supply Application

VOUT pin

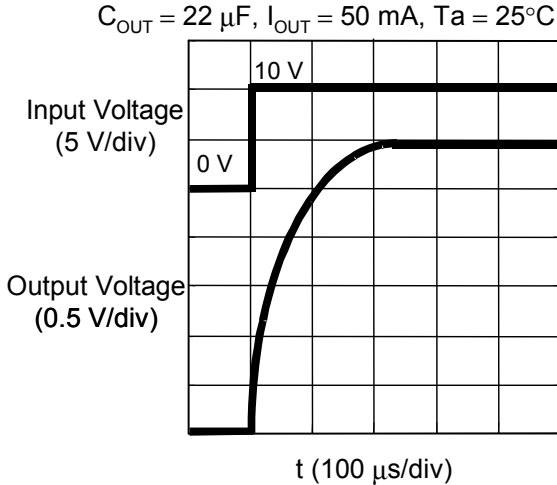

Figure 12 Ringing Waveform of Power Supply Application (VOUT Pin)

VRO pin

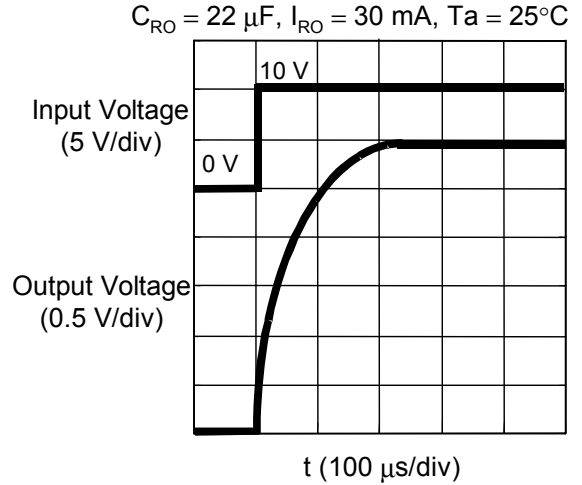
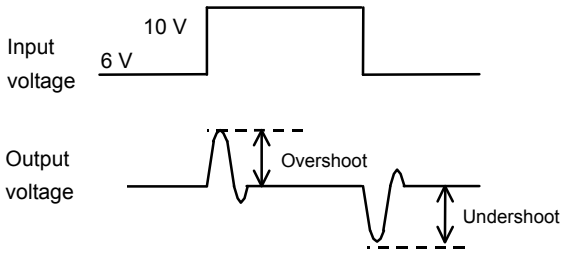

Figure 13 Ringing Waveform of Power Supply Application (VRO Pin)

Power supply variation: 6 V and 10 V square waves



**Figure 14 Power Supply Variation:
6 V and 10 V Square Waves**

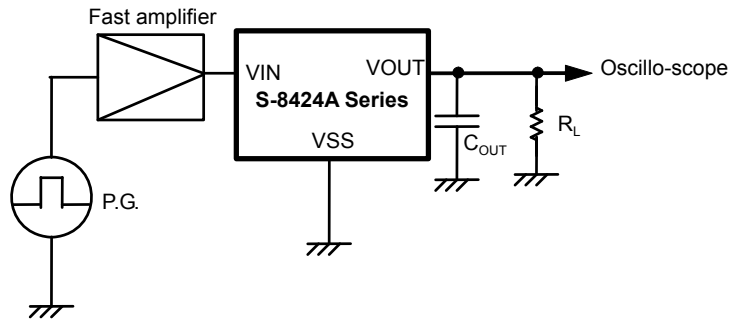

Figure 15 Test Circuit

Power Supply Variation

VOUT pin

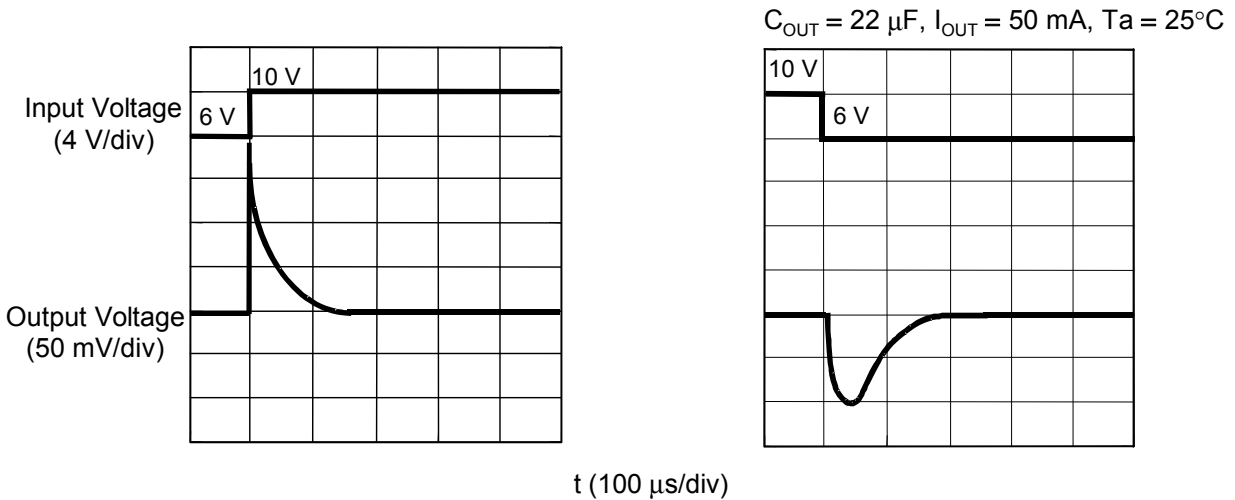

Figure 16 Ringing Waveform of Power Supply Variation (VOUT Pin)

VRO pin

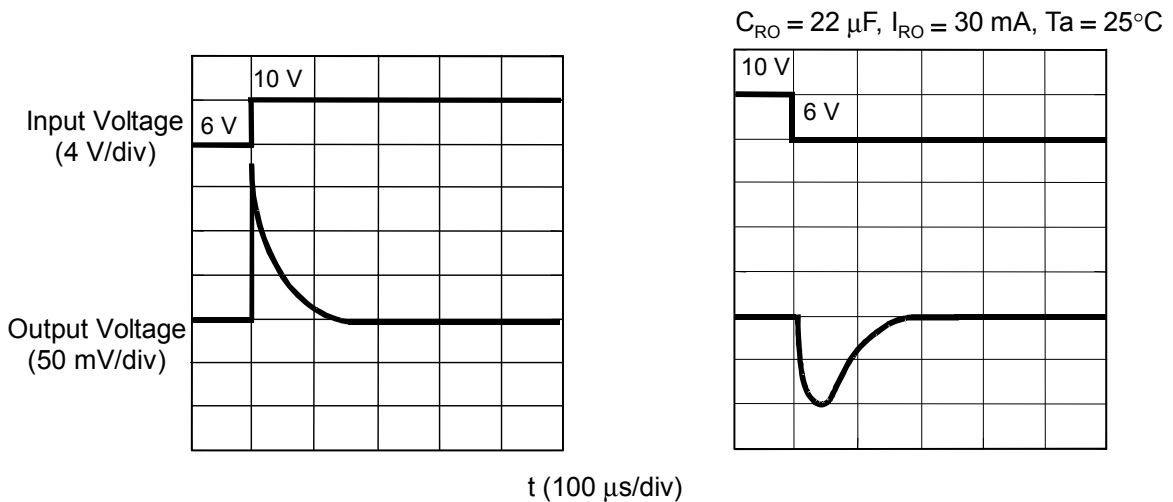

Figure 17 Ringing Waveform of Power Supply Variation (VRO Pin)

Reference data: Dependency of output current (I_{OUT}), load capacitance (C_{OUT}), input variation width (ΔV_{IN}), temperature (T_a)

For reference, the following pages describe the results of measuring the ringing amounts at the VOUT and VRO pins using the output current (I_{OUT}), load capacitance (C_{OUT}), input variation width (ΔV_{IN}), and temperature (T_a) as parameters.

1.1 I_{OUT} Dependency

(1) VOUT pin

$C_{OUT} = 22 \mu F$, $V_{IN} = 6 V$ and $10 V$, $T_a = 25^\circ C$

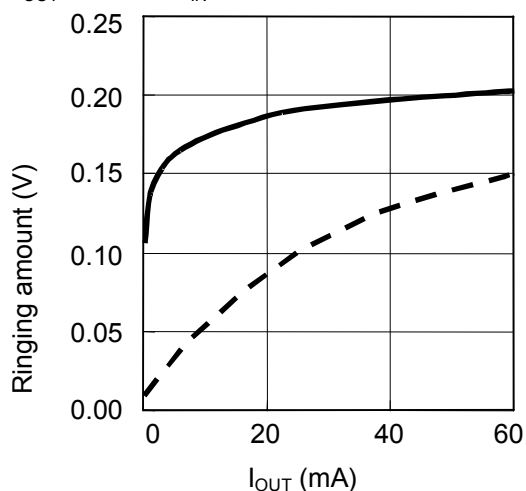

(2) VRO pin

$C_{RO} = 22 \mu F$, $V_{IN} = 6 V$ and $10 V$, $T_a = 25^\circ C$

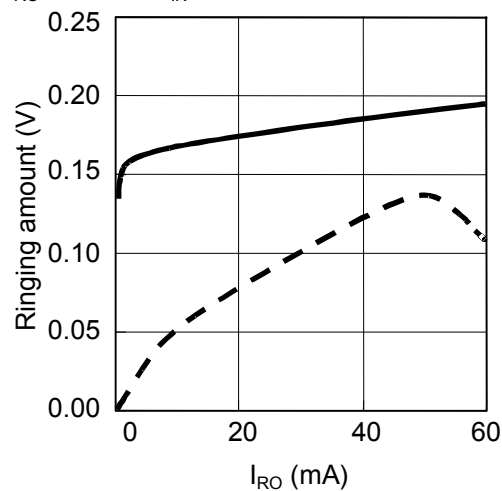

1.2 C_{OUT} Dependency

(1) VOUT pin

$I_{OUT} = 50 mA$, $V_{IN} = 6 V$ and $10 V$, $T_a = 25^\circ C$

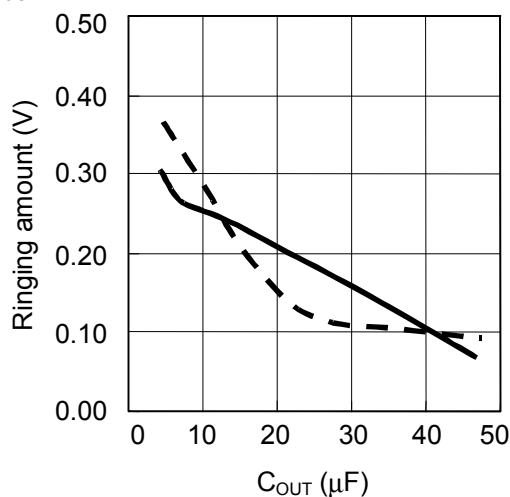

(2) VRO pin

$I_{RO} = 30 mA$, $V_{IN} = 6 V$ and $10 V$, $T_a = 25^\circ C$

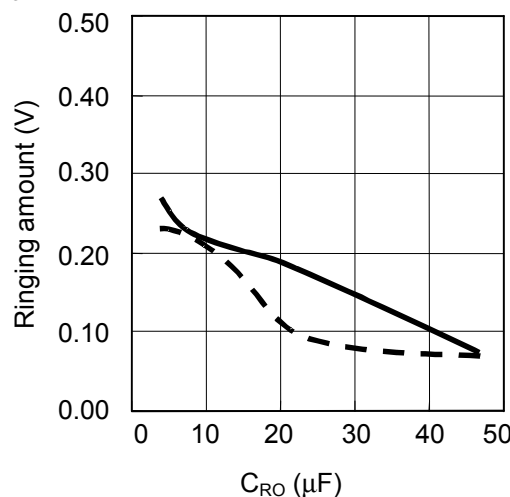

— Overshoot
 - - Undershoot

1.3 ΔV_{IN} Dependency

ΔV_{IN} shows the difference between the low voltage fixed to 6 V and the high voltage.
For example, $\Delta V_{IN} = 2$ V means the difference between 6 V and 8 V.

(1) VOUT pin

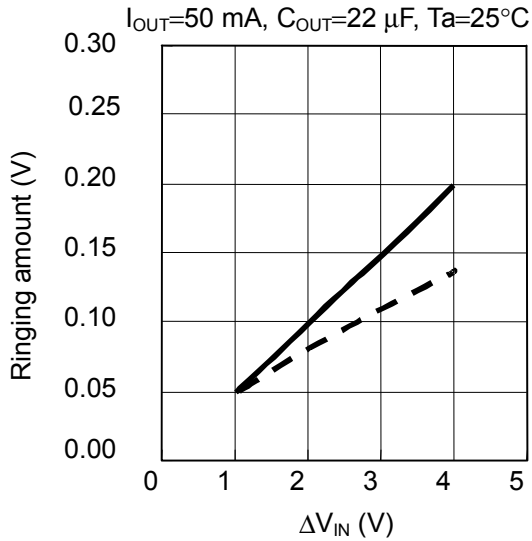

(2) VRO pin

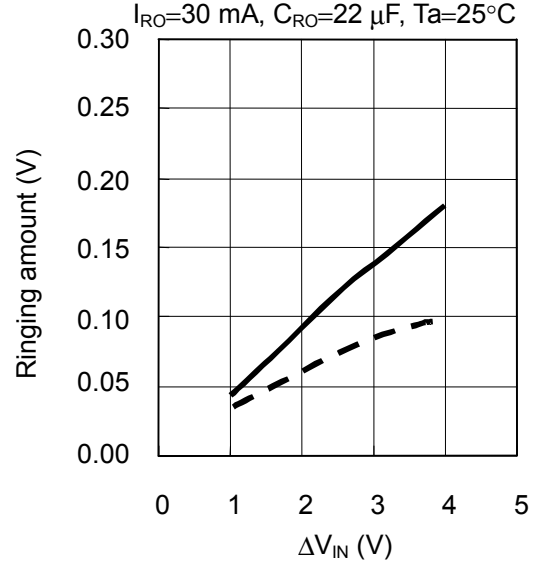

1.4 Temperature Dependency

(1) VOUT pin

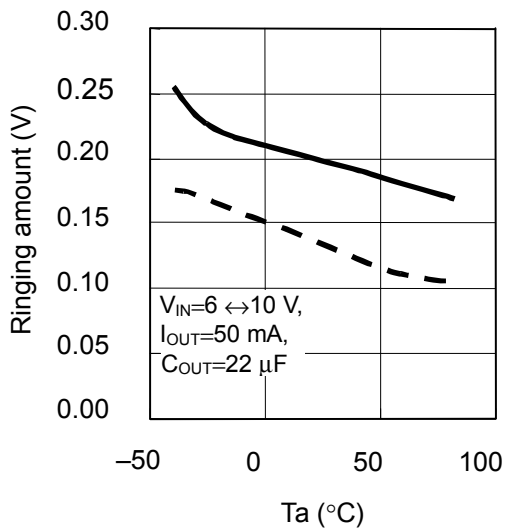

(2) VRO pin

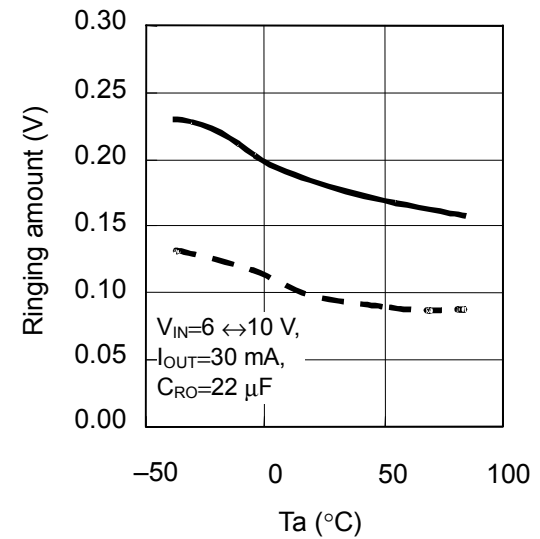

— Overshoot
- - - Undershoot

2. Load Transient Response Based on Output Current Fluctuation

The overshoot and undershoot are caused in the output voltage if the output current fluctuates between 10 μ A and 50 mA (V_{RO} is between 10 μ A and 30 mA) while the input voltage is constant. **Figure 18** shows the output voltage variation due to the output current. **Figure 19** shows the test circuit for reference. The latter half of this section describes ringing waveform and parameter dependency.

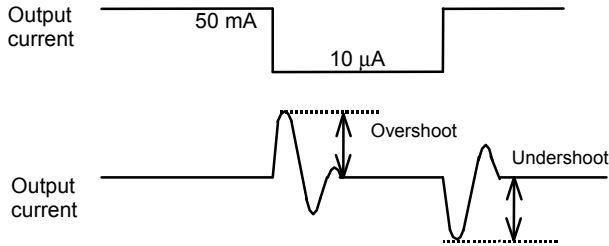

Figure 18 Output Voltage Variation due to Output Current

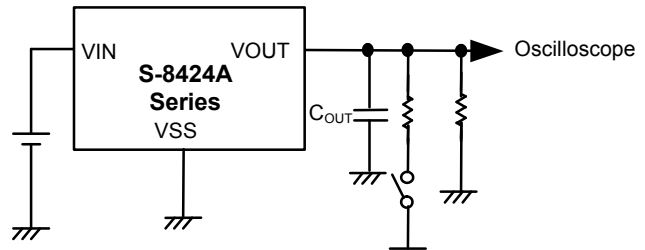
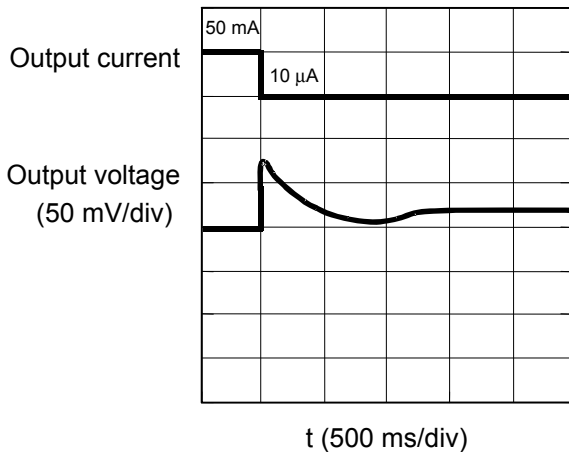

Figure 19 Test Circuit

Figure 20 shows the ringing waveforms at the VOUT pin and **Figure 21** shows the ringing waveforms at the VRO pin due to the load variation, respectively.

VOUT pin



$V_{IN} = 6.0 \text{ V}, C_{OUT} = 22 \mu\text{F}, T_a = 25^\circ\text{C}$

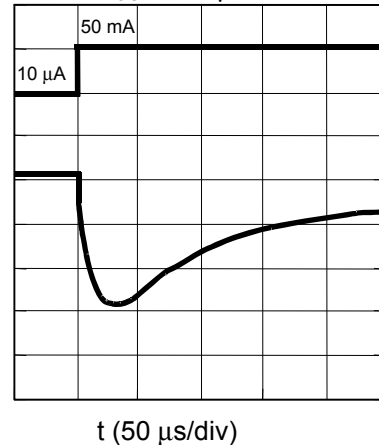
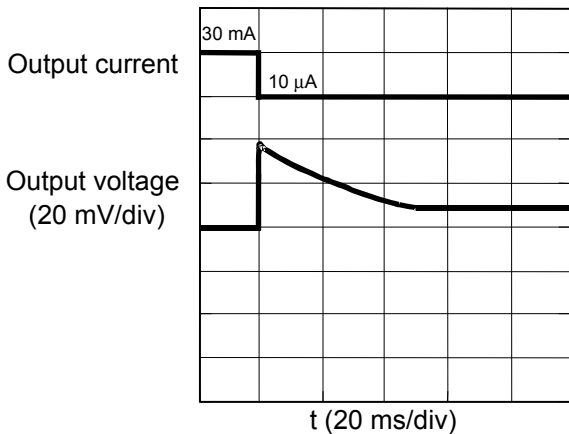

Figure 20 Ringing Waveform due to Load Variation (VOUT Pin)

VRO pin



$V_{IN}=6.0 \text{ V}, C_{RO}=22 \mu\text{F}, T_a=25^\circ\text{C}$

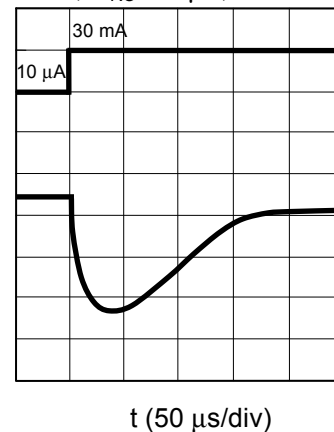

Figure 21 Ringing Waveform due to Load Variation (VRO Pin)

Reference data: Dependency of input voltage (V_{IN}), load capacitance (C_{OUT}), output variation width (ΔI_{OUT}), and temperature (T_a)

2.1 V_{IN} Dependency

(1) V_{OUT} pin

$C_{OUT} = 22 \mu F$, $I_{OUT} = 50 \text{ mA}$ and $10 \mu A$, $T_a = 25^\circ C$

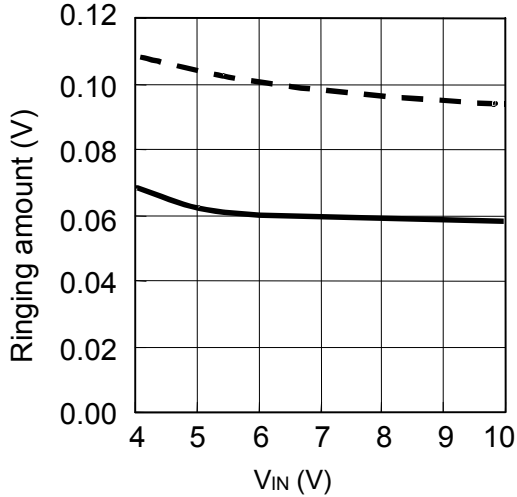

(2) V_{RO} pin

$C_{RO} = 22 \mu F$, $I_{RO} = 30 \text{ mA}$ and $10 \mu A$, $T_a = 25^\circ C$

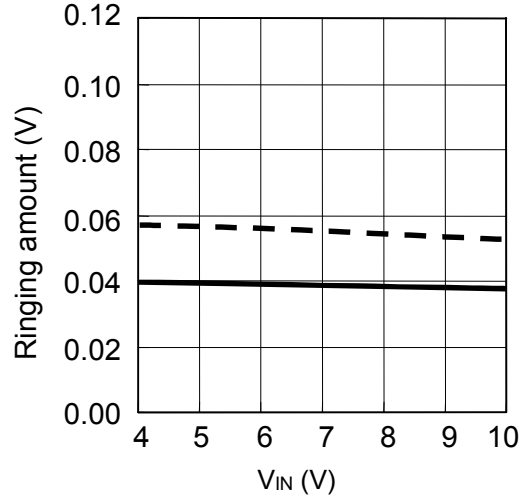

2.2 C_{OUT} Dependency

(1) V_{OUT} pin

$V_{IN} = 6.0 \text{ V}$, $I_{OUT} = 50 \text{ mA}$ and $10 \mu A$, $T_a = 25^\circ C$

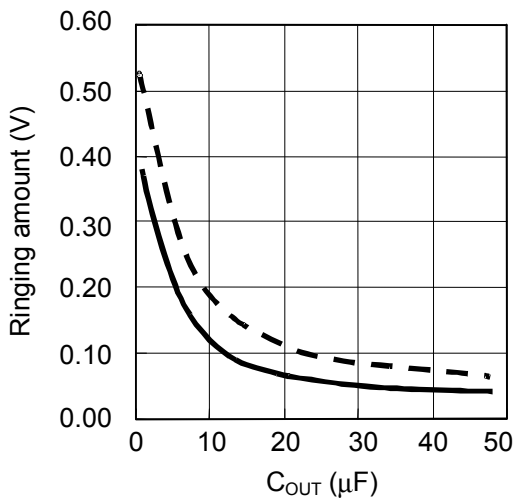

(2) V_{RO} pin

$V_{IN} = 6.0 \text{ V}$, $I_{RO} = 30 \text{ mA}$ and $10 \mu A$, $T_a = 25^\circ C$

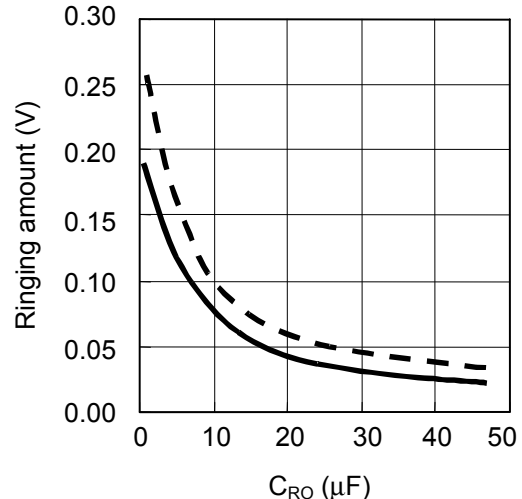

— Overshoot
 - - - Undershoot

2.3 ΔI_{OUT} Dependency

ΔI_{OUT} and ΔI_{RO} show the fluctuation between the low current stabilized at 10 μA and the high current. For example, $\Delta I_{OUT} = 10$ mA means a fluctuation between 10 μA and 10 mA.

(1) VOUT pin

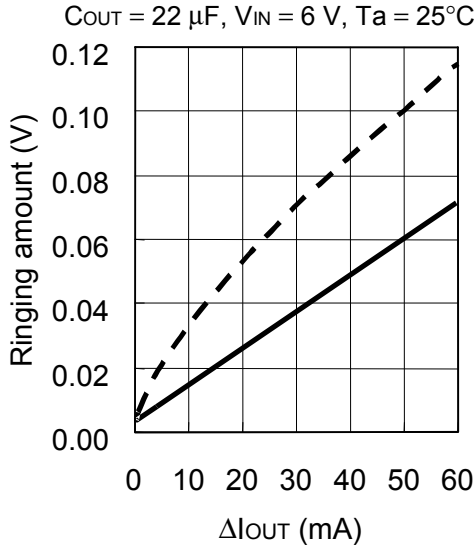

(2) VRO pin

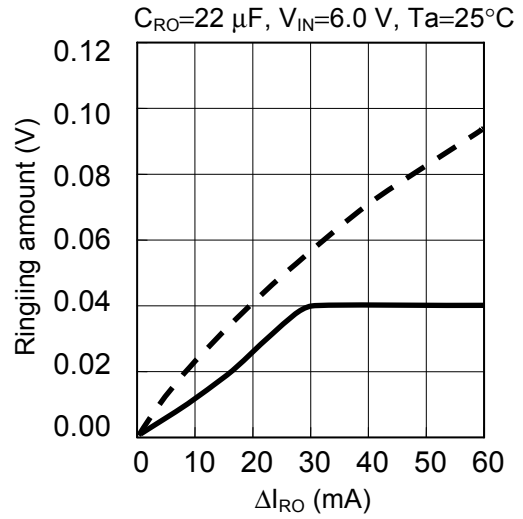

2.4 Temperature Dependency

(1) VOUT pin

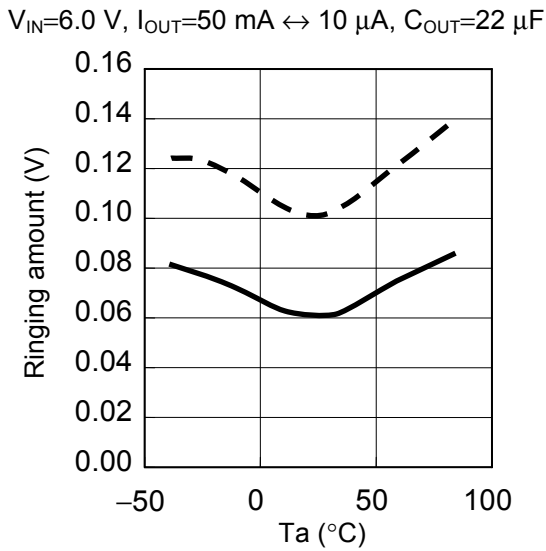

(2) VRO pin

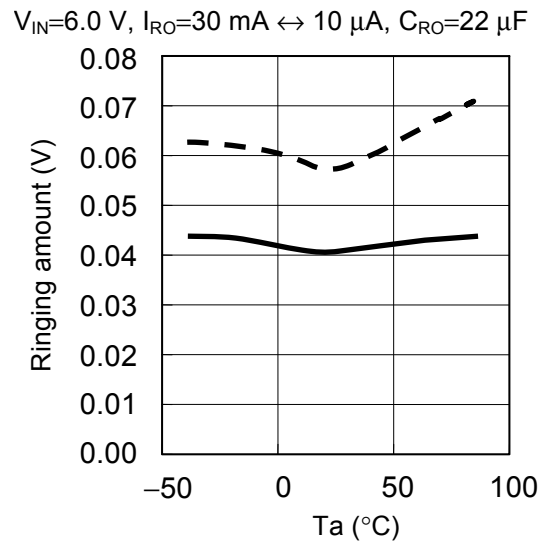

— Overshoot
- - - Undershoot

■ Standard Circuit

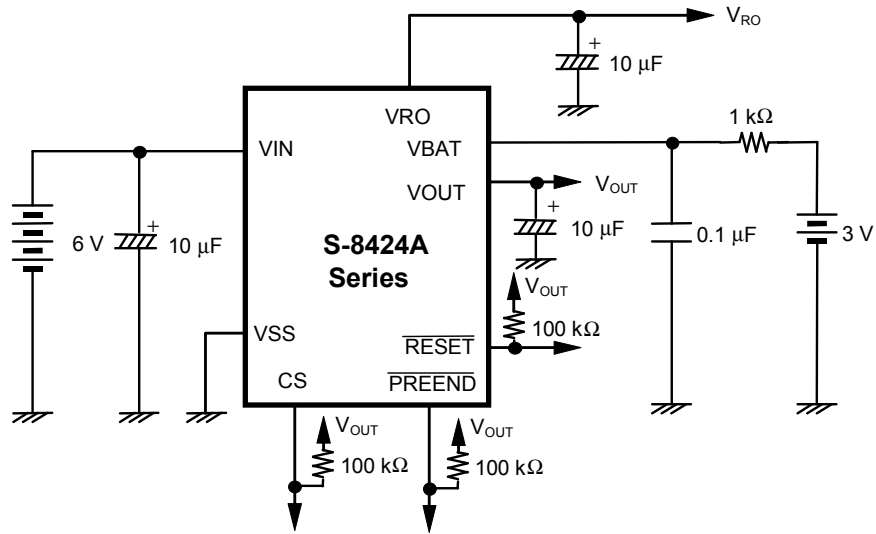

Figure 22 Standard Circuit

- Caution 1.** Be sure to add a 10 µF or more capacitor to the VOUT and VRO pins.
- 2.** The above connections and values will not guarantee correct operation. Before setting these values, perform sufficient evaluation on the application to be actually used.

■ Precautions

- In applications with small I_{RO} or I_{OUT} , the output voltages V_{RO} and V_{OUT} may rise, causing the load stability to exceed standard levels. Set I_{RO} and I_{OUT} to 10 μ A or more.
- Attach the proper capacitor to the VOUT pin to prevent the $\overline{\text{RESET}}$ voltage detector (which monitors the VOUT pin) from coming active due to undershoot.
- Watch for overshoot and ensure it does not exceed the ratings of the IC chips and/or capacitors attached to the VRO and VOUT pins.
- Add a 10 μ F or more capacitor to the VOUT and VRO pins.
- When V_{IN} rises from the voltage more than V_{SW1} , a low pulse of less than 4 ms flows through the $\overline{\text{PREEND}}$ pin even when V_{BAT} is more than the $\overline{\text{PREEND}}$ release voltage. Thus when monitoring the $\overline{\text{PREEND}}$ pin, make sure to take the 4 ms interval or more after the rise of V_{IN} .
- Do not apply an electrostatic discharge to this IC that exceeds the performance ratings of the built-in electrostatic protection circuit.

■ Application Circuits

1. When Using Timer Micro controllers for Backup to display $\overline{\text{PREEND}}$ in the primary CPU

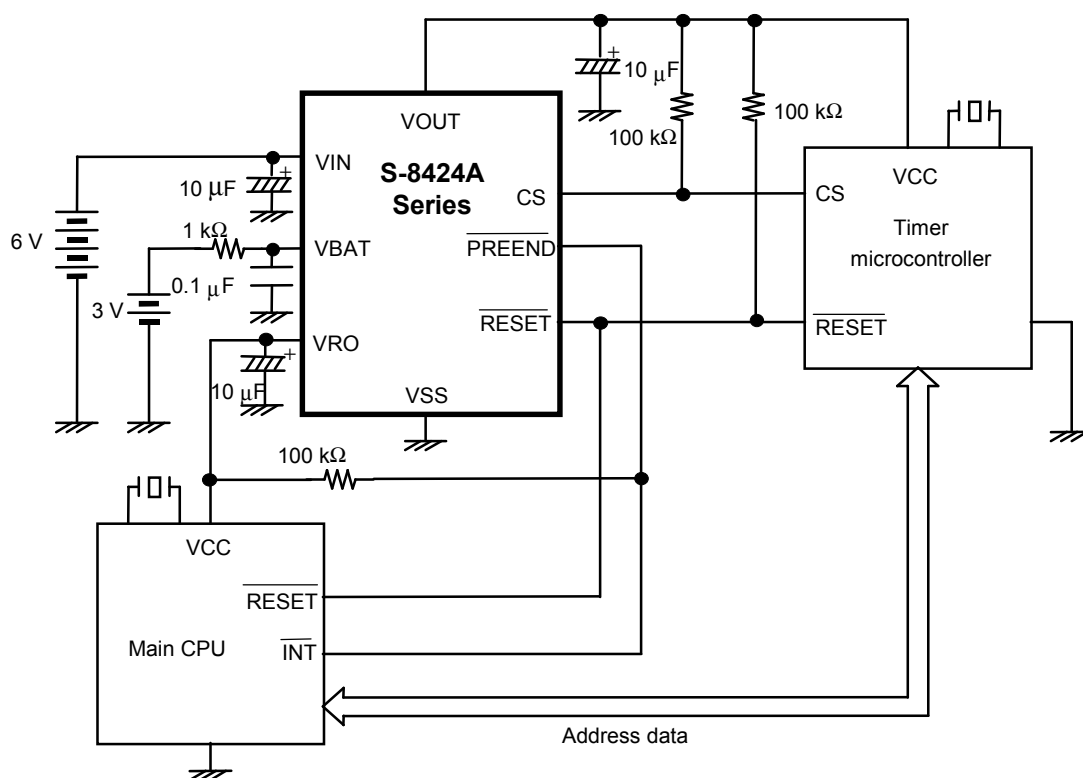

Figure 23 Application Circuit 1

2. When Using Secondary Battery as Backup Battery

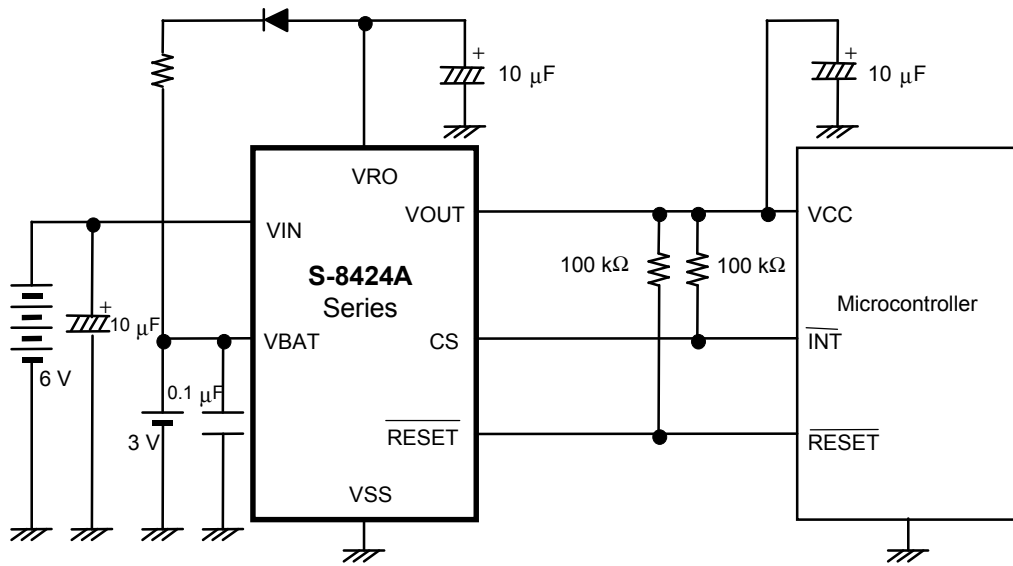

Figure 24 Application Circuit 2

Remark The backup battery can be floating-recharged by using voltage regulator 1.

3. Memory Card

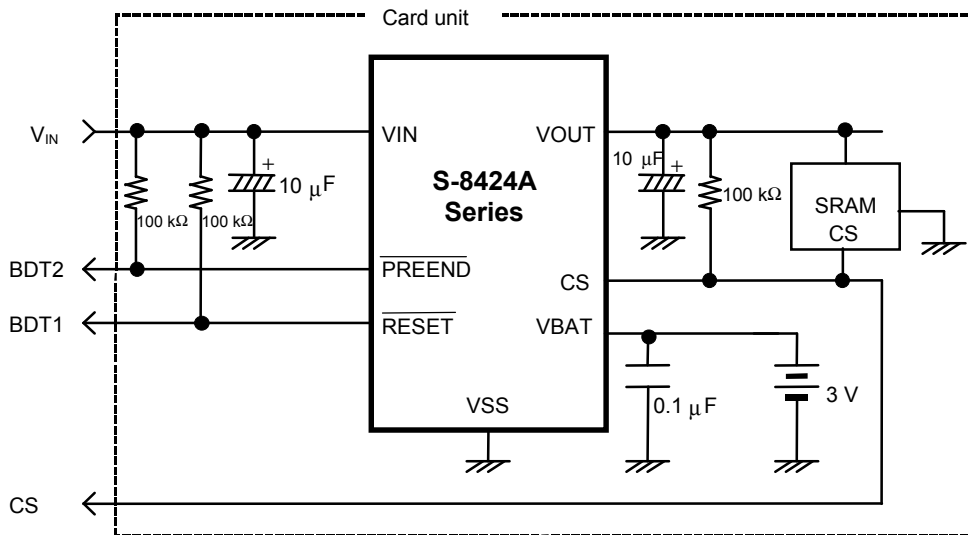

Figure 25 Application Circuit 3

Caution The above connections and values will not guarantee correct operation. Before setting these values, perform sufficient evaluation on the application to be actually used.

■ Characteristics

1. Voltage Regulator Unit ($V_{RO} = V_{OUT} = 3.0\text{ V}$)

1.1 Input Voltage (V_{IN}) vs. Output Voltage (V_{RO}) Characteristics (REG1)

(1) $T_a = 85^\circ\text{C}$

$I_{RO} = 10\text{ mA}, 30\text{ mA}, 50\text{ mA}, 70\text{ mA}, 90\text{ mA}$

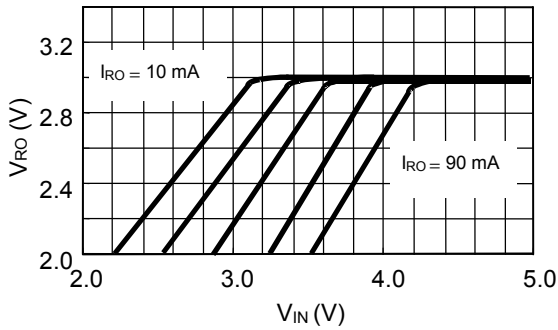

(2) $T_a = 25^\circ\text{C}$

$I_{RO} = 10\text{ mA}, 30\text{ mA}, 50\text{ mA}, 70\text{ mA}, 90\text{ mA}$

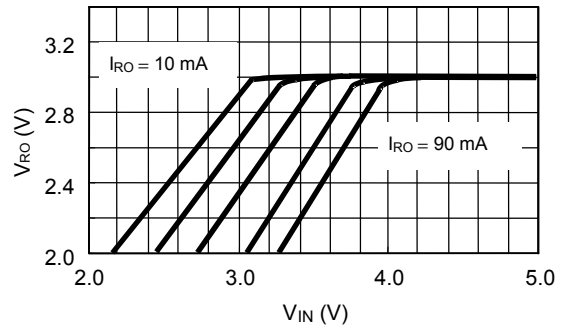

(3) $T_a = -40^\circ\text{C}$

$I_{RO} = 10\text{ mA}, 30\text{ mA}, 50\text{ mA}, 70\text{ mA}, 90\text{ mA}$

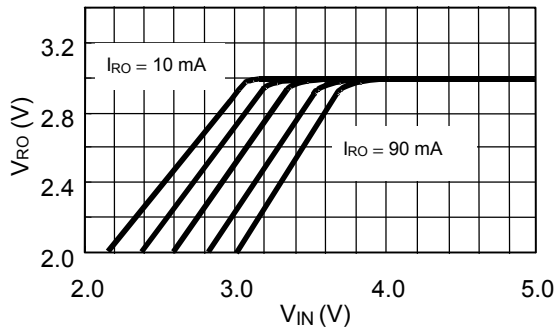

1.2 Input Voltage (V_{IN}) vs. Output Voltage (V_{OUT}) Characteristics (REG2)

(1) $T_a = 85^\circ\text{C}$

$I_{OUT} = 10\text{ mA}, 30\text{ mA}, 50\text{ mA}, 70\text{ mA}, 90\text{ mA}$

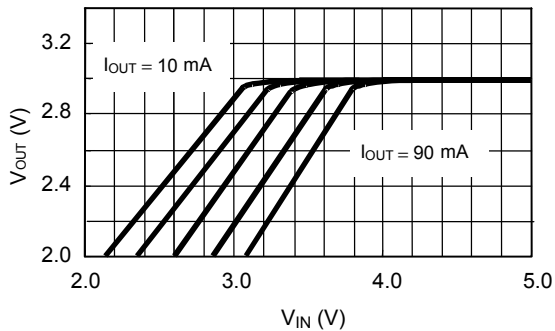

(2) $T_a = 25^\circ\text{C}$

$I_{OUT} = 10\text{ mA}, 30\text{ mA}, 50\text{ mA}, 70\text{ mA}, 90\text{ mA}$

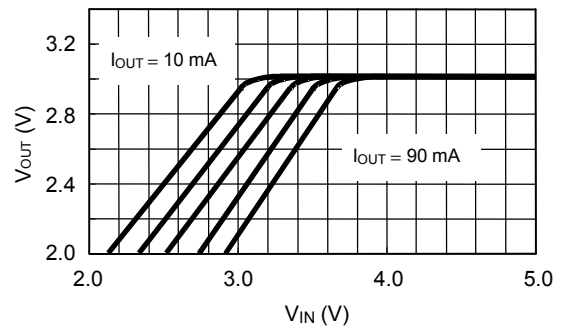

(3) $T_a = -40^\circ\text{C}$

$I_{OUT} = 10\text{ mA}, 30\text{ mA}, 50\text{ mA}, 70\text{ mA}, 90\text{ mA}$

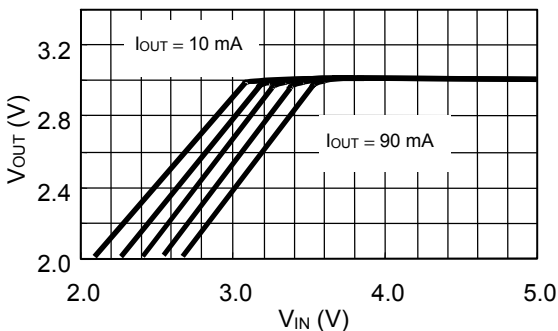

1.3 Output Current (I_{RO}) vs. Dropout Voltage (V_{drop1}) Characteristics

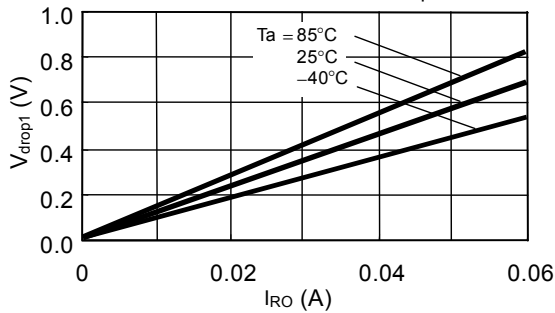

1.4 Output Current (I_{OUT}) vs. Dropout Voltage (V_{drop2}) Characteristics

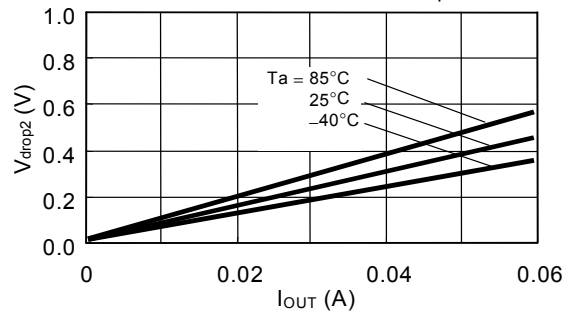

1.5 Output Current (I_{RO}) vs. Output Voltage (V_{RO}) Characteristics

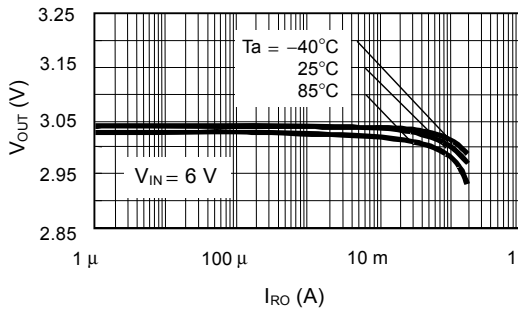

1.6 Output Current (I_{OUT}) vs. Output Voltage (V_{OUT}) Characteristics

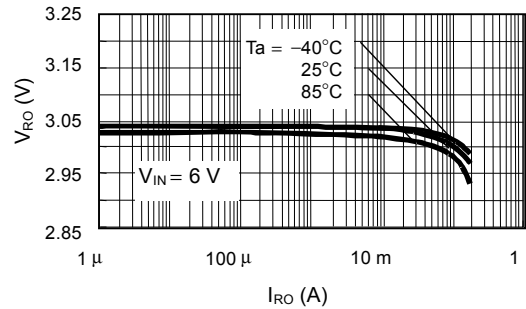

1.7 Output voltage (V_{RO}) Temperature Characteristics

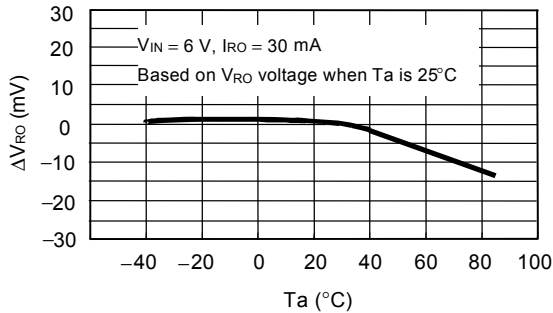

1.8 Output voltage (V_{OUT}) Temperature Characteristics

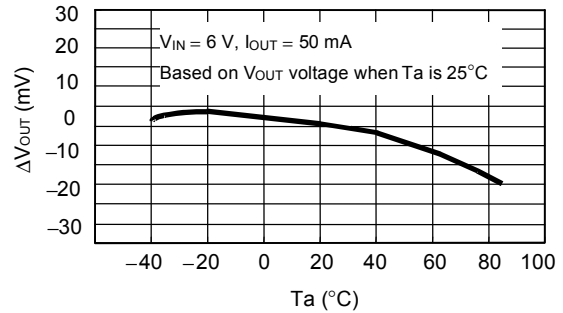

1.9 Input Stability (V_{RO}) Temperature Characteristics

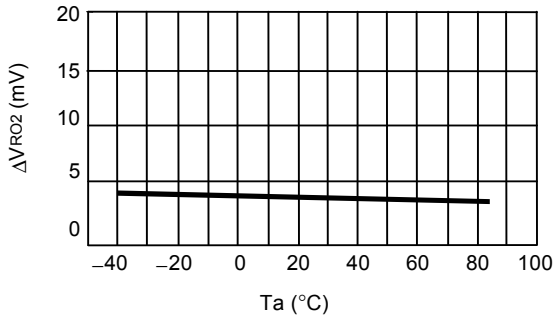

1.10 Input Stability (V_{OUT}) Temperature Characteristics

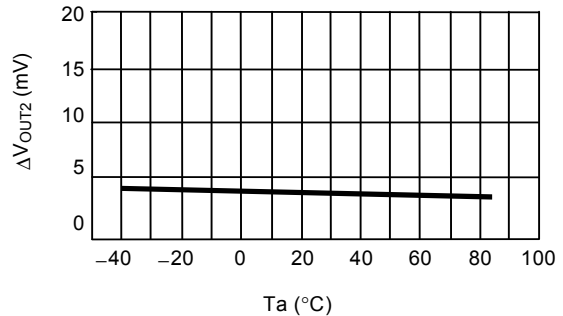

1.11 Load Stability (V_{RO}) Temperature Characteristics

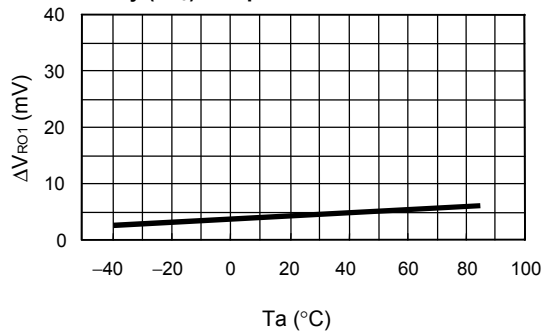

1.12 Load Stability (V_{RO}) Temperature Characteristics

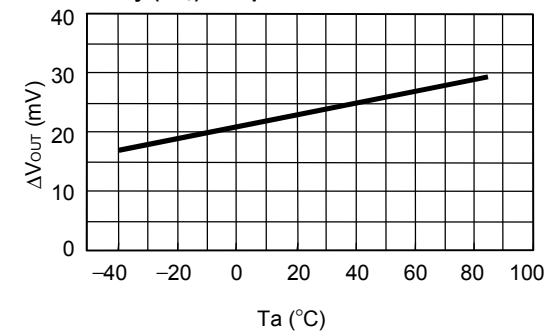

2. Voltage Detector

2.1 CS Voltage Detector ($-V_{DET1} = 3.3\text{ V}$)

(1) Detection voltage ($-V_{DET1}$) temperature characteristics

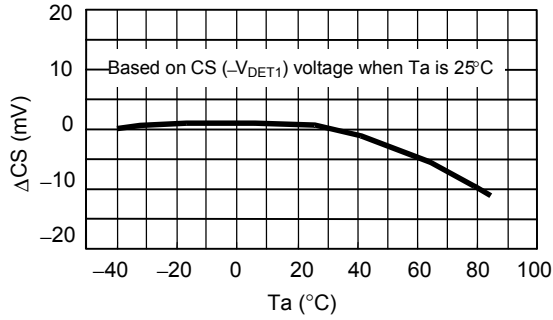

(2) Output current (I_{SINK}) characteristics

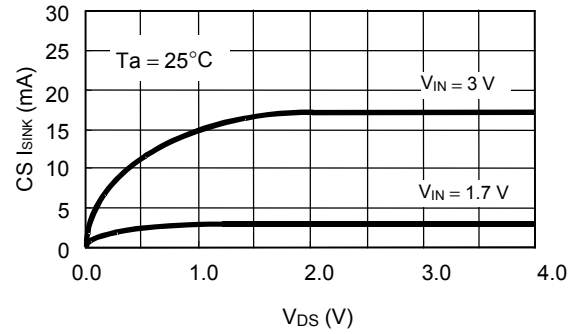

(3) Output current (I_{SINK}) temperature characteristics

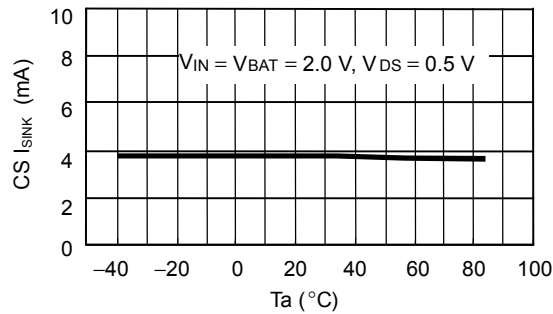

2.2 $\overline{\text{RESET}}$ Voltage Detector ($-V_{DET2} = 2.2\text{ V}$)

(1) Detection voltage ($-V_{DET2}$) temperature characteristics

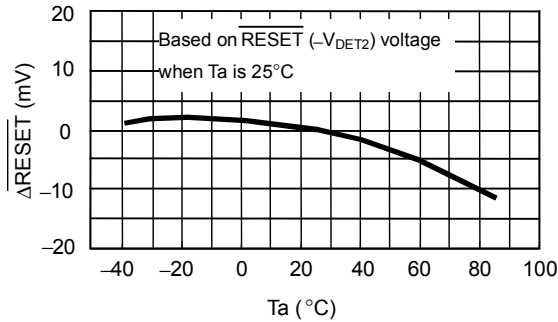

(2) Output current (I_{SINK}) characteristics

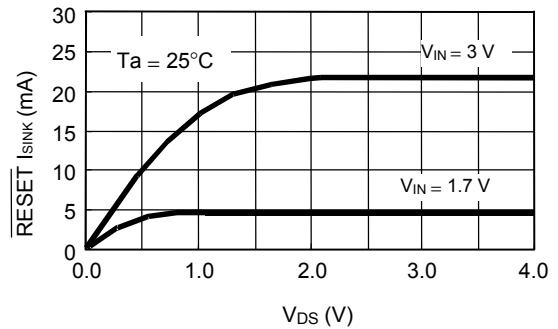

(3) Output current (I_{SINK}) temperature characteristics

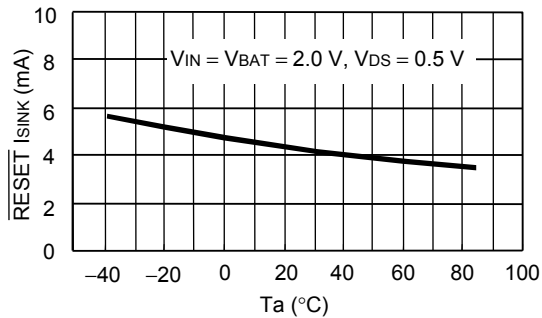

2.3 PREEND Voltage Detector ($-V_{DET3} = 2.6\text{ V}$)

(1) Detection voltage ($-V_{DET3}$) temperature characteristics

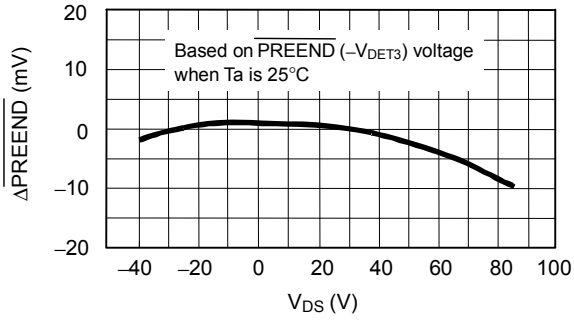

(2) Output current (I_{SINK}) characteristics

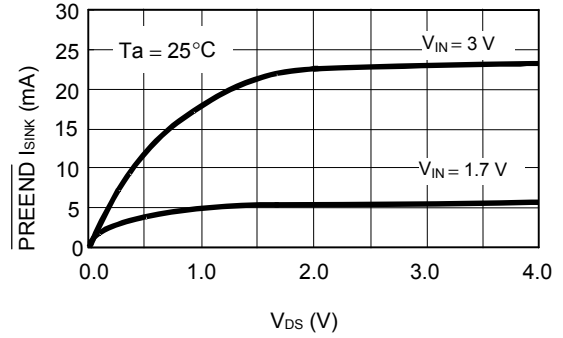

(3) Output current (I_{SINK}) temperature characteristics

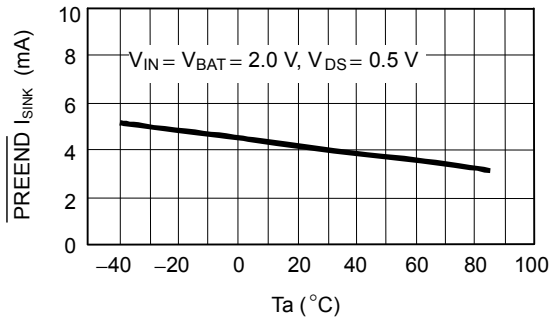

3. Switch Unit

3.1 Switch Voltage (V_{SW1}) Temperature Characteristics

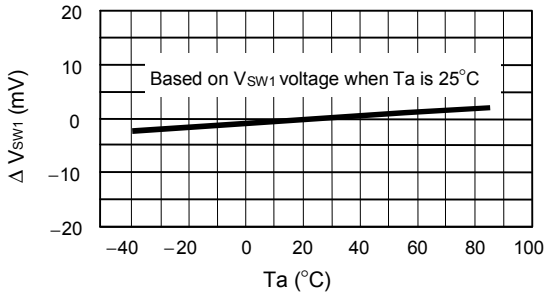

3.2 CS Output Inhibit Voltage (V_{SW2}) Temperature Characteristics

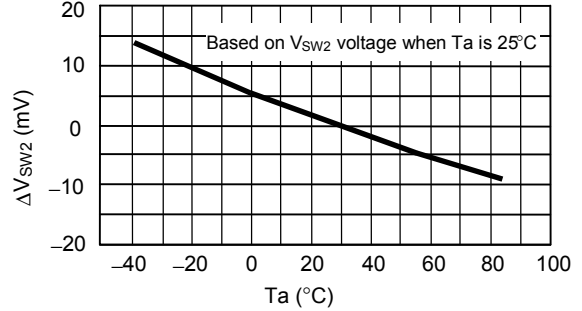

3.3 Input Voltage (V_{BAT}) vs. V_{BAT} Switch Resistance (R_{SW}) Characteristics

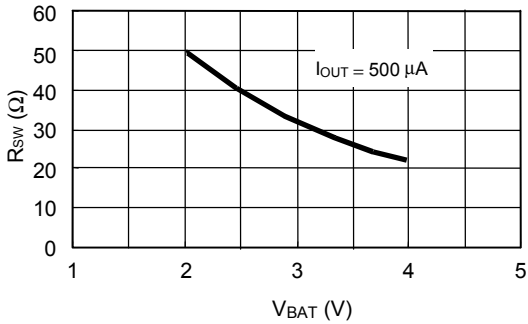

3.4 V_{BAT} Switch Resistance (R_{SW}) Temperature Characteristics

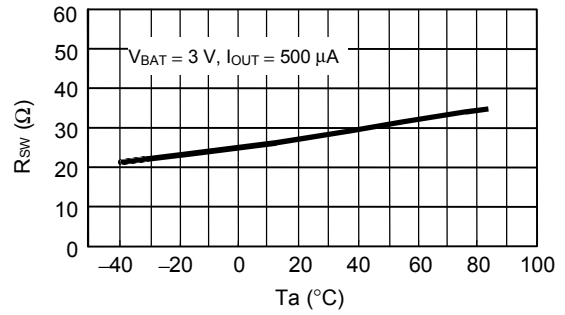

3.5 V_{BAT} Switch Leakage Current (I_{LEAK}) Temperature Characteristics

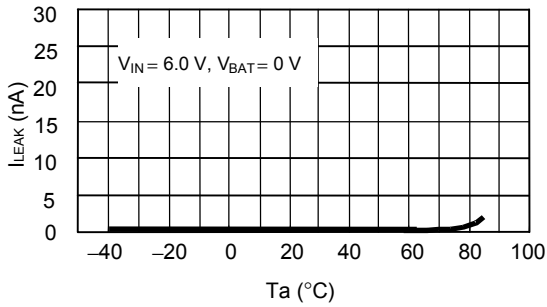

4. Consumption Current

4.1 V_{IN} vs. V_{IN} Consumption Current (I_{SS1}) Characteristics

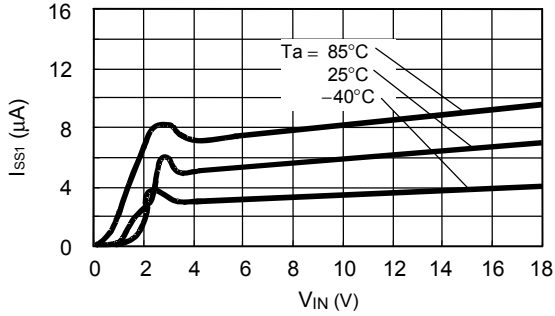

4.2 V_{BAT} vs. V_{BAT2} Consumption Current (I_{BAT2}) Characteristics

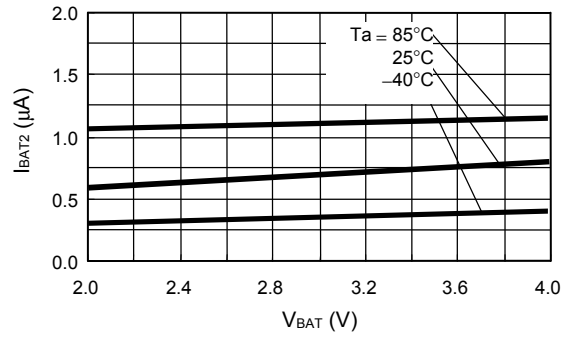

4.3 Consumption Current Temperature Characteristics

(1) I_{SS1}

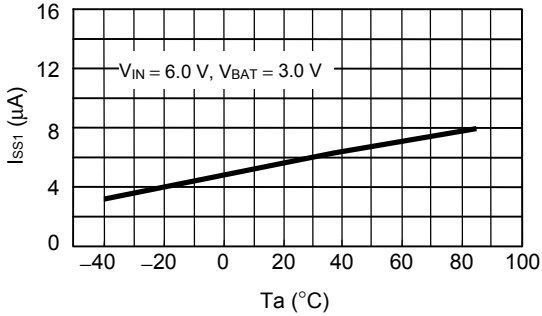

(2) I_{BAT2}

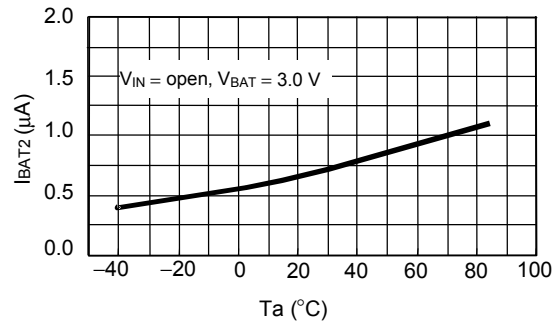

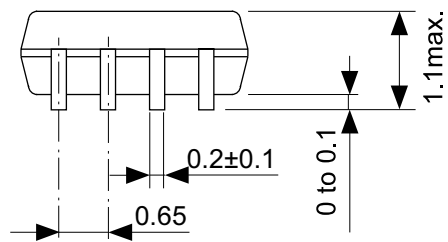
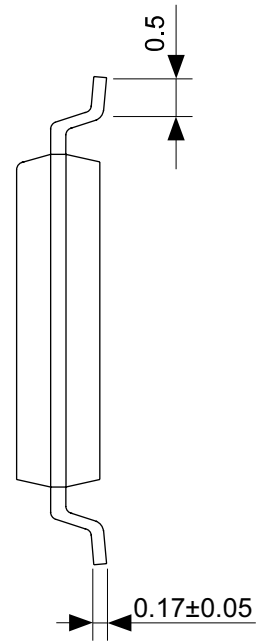

No. FT008-A-P-SD-1.1

TITLE	TSSOP8-E-PKG Dimensions
No.	FT008-A-P-SD-1.1
SCALE	
UNIT	mm
SII Semiconductor Corporation	

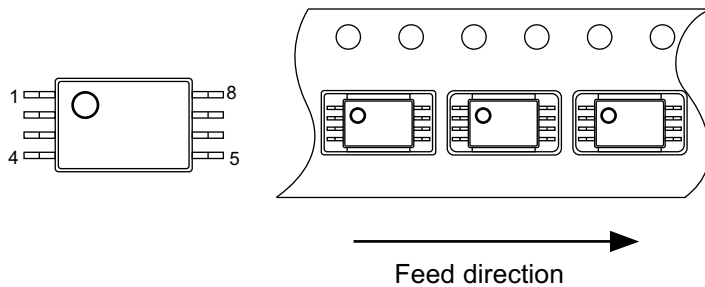
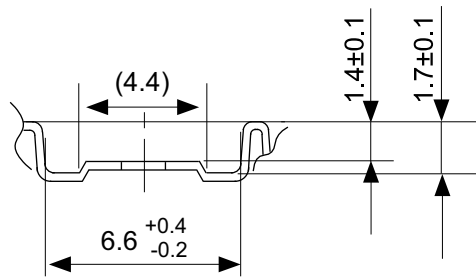
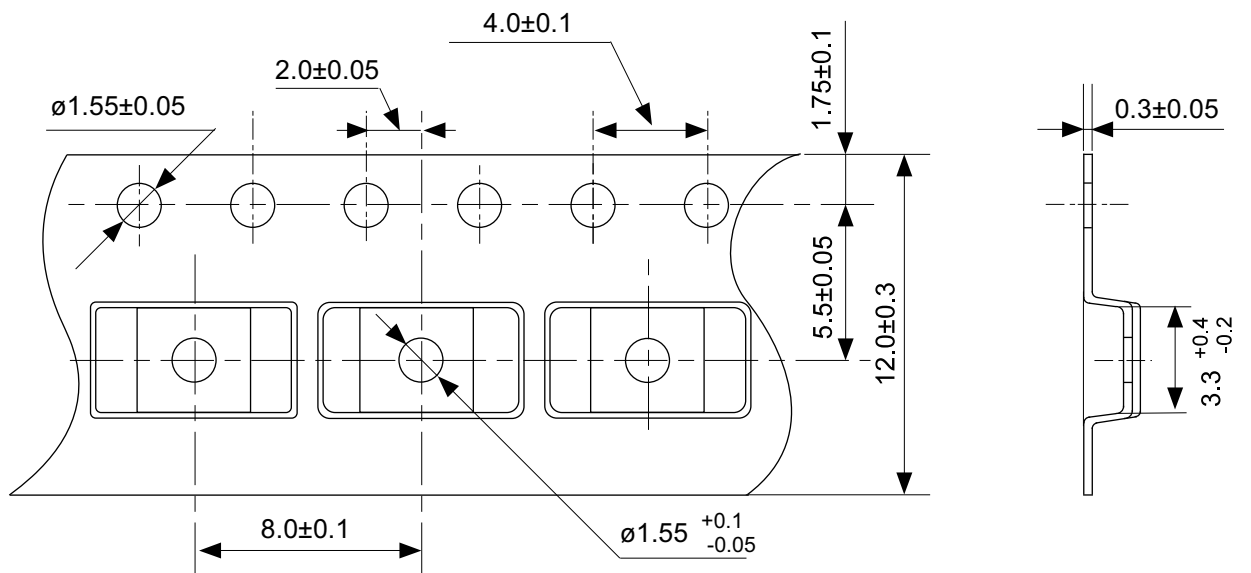

No. FT008-E-C-SD-1.0

TITLE	TSSOP8-E-Carrier Tape
No.	FT008-E-C-SD-1.0
SCALE	
UNIT	mm
SII Semiconductor Corporation	

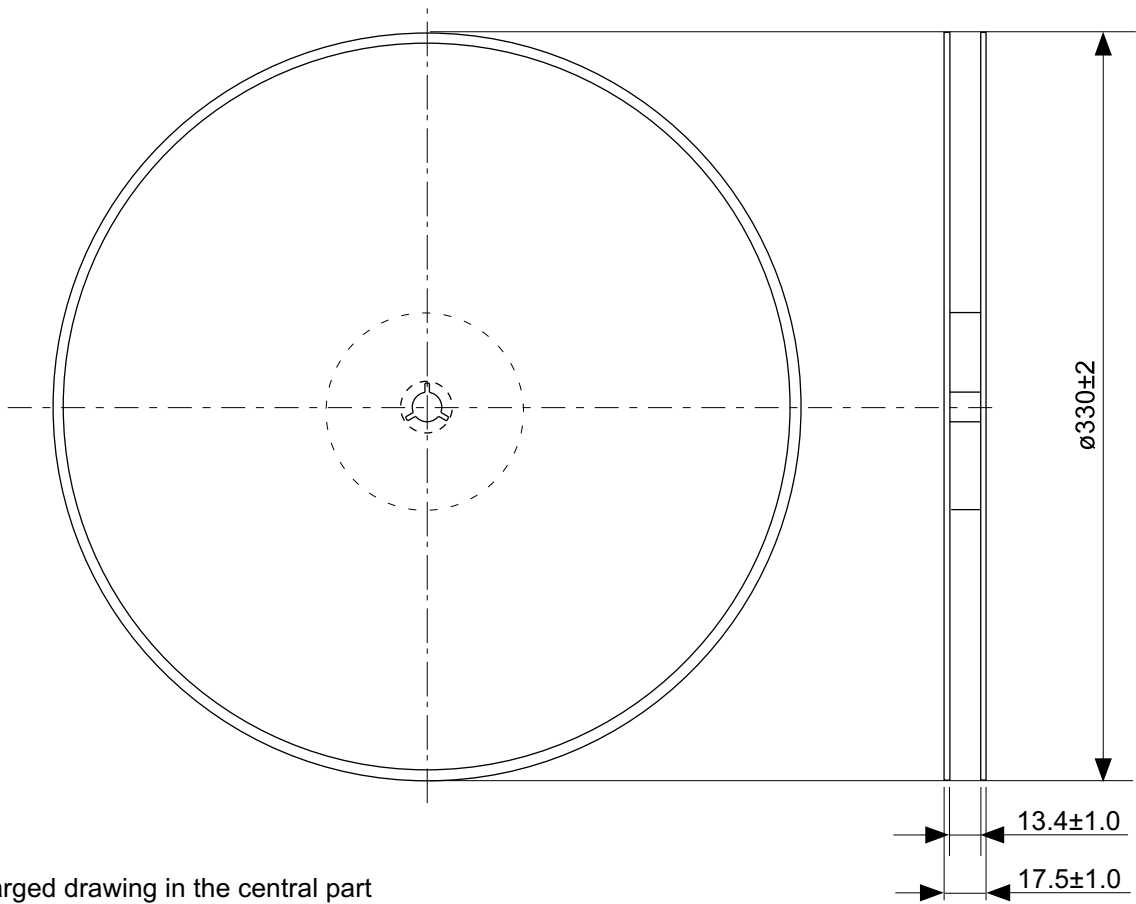

Enlarged drawing in the central part

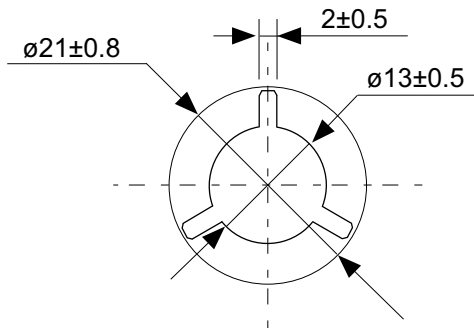

No. FT008-E-R-SD-1.0

TITLE	TSSOP8-E-Reel		
No.	FT008-E-R-SD-1.0		
SCALE		QTY.	3,000
UNIT	mm		
SII Semiconductor Corporation			

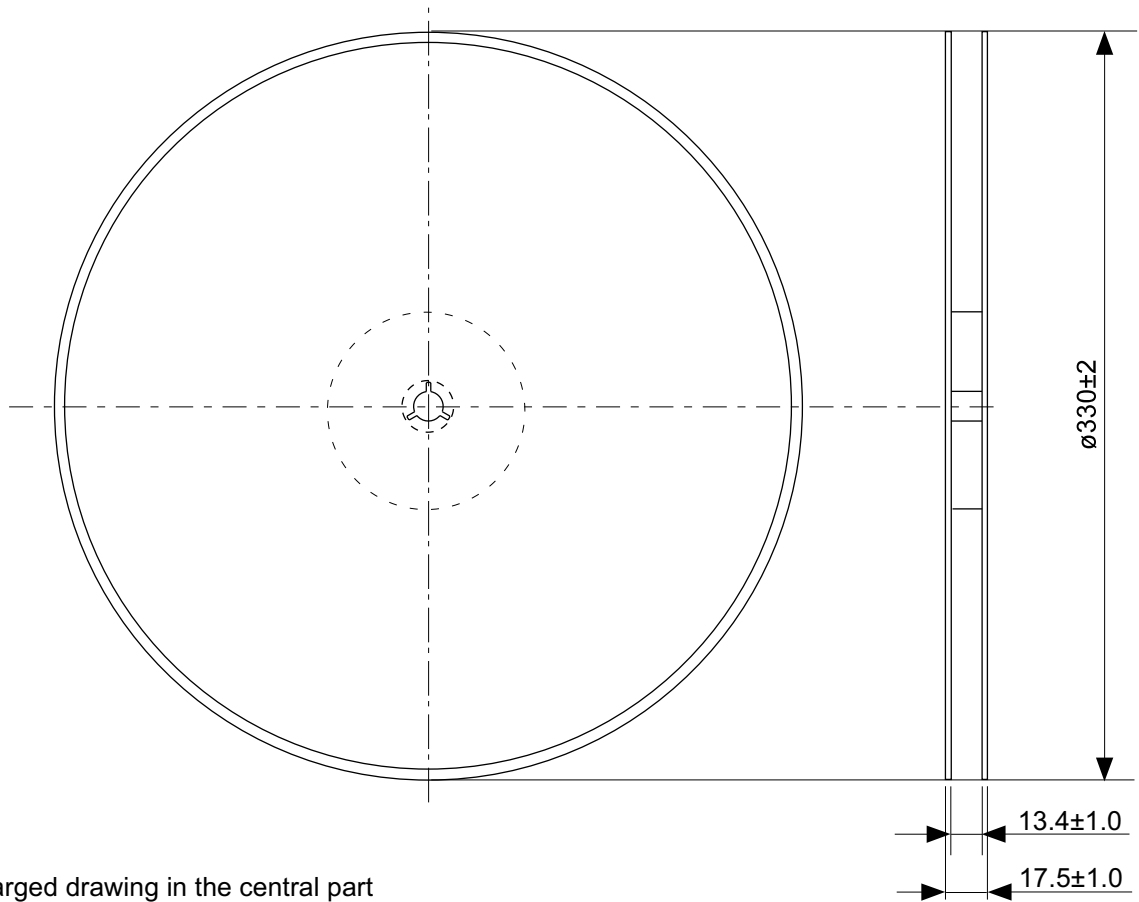

Enlarged drawing in the central part

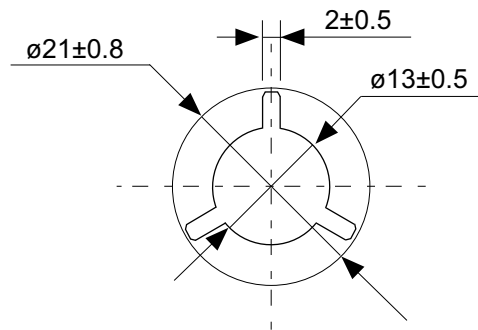

No. FT008-E-R-S1-1.0

TITLE	TSSOP8-E-Reel		
No.	FT008-E-R-S1-1.0		
SCALE		QTY.	4,000
UNIT	mm		
SII Semiconductor Corporation			

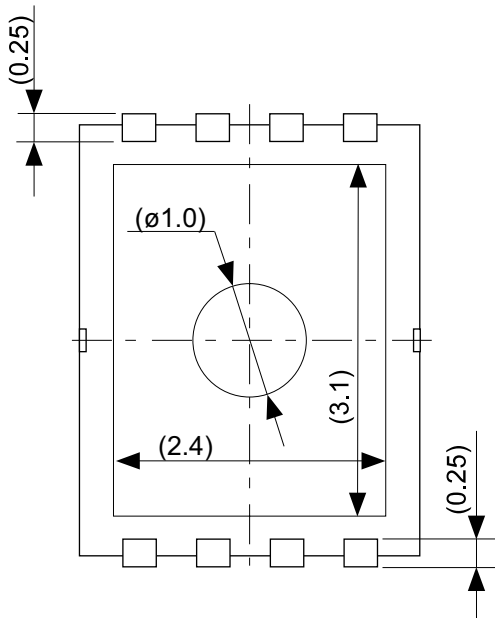
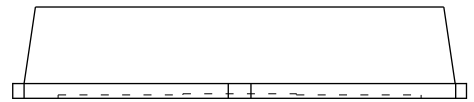
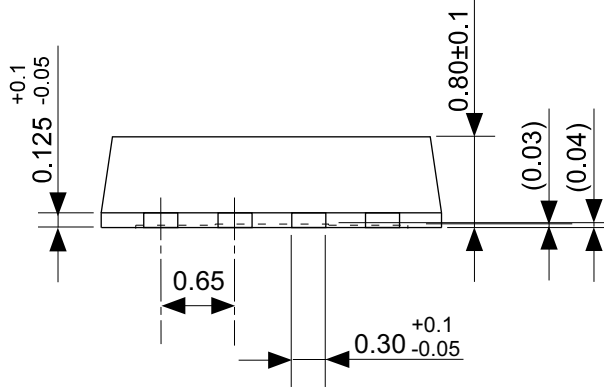
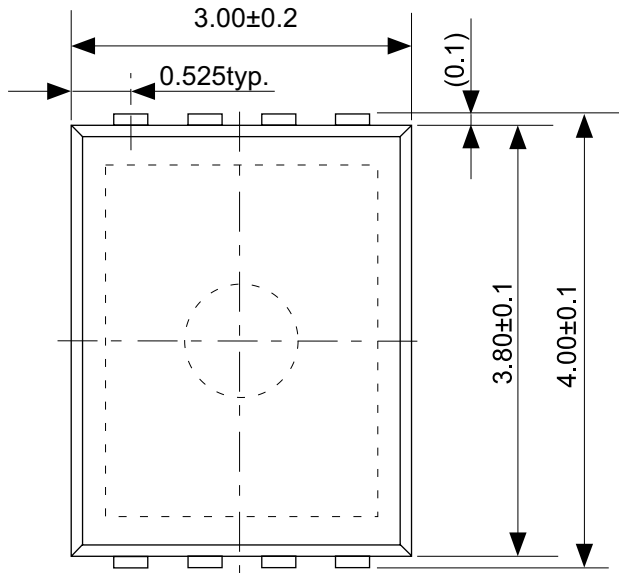

No. PA008-B-P-SD-3.0

TITLE	SON8B-B-PKG Dimensions
No.	PA008-B-P-SD-3.0
SCALE	
UNIT	mm

SII Semiconductor Corporation

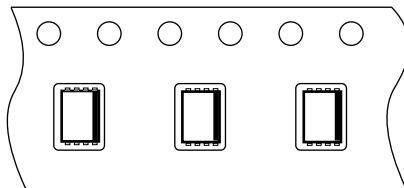
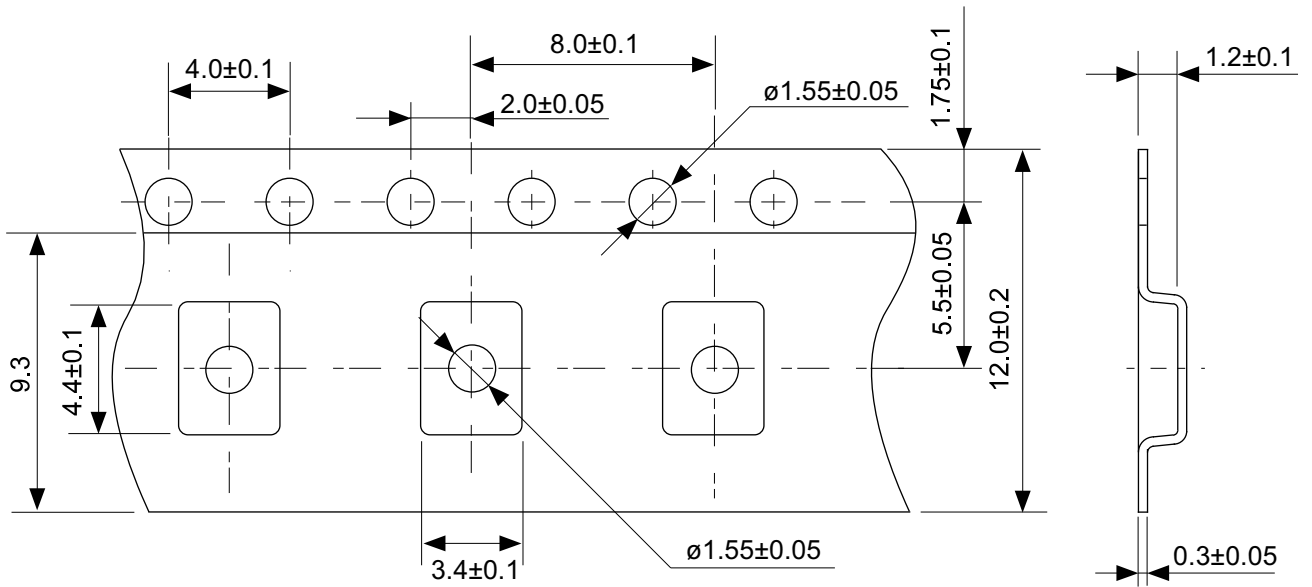

→
Feed direction

No. PA008-B-C-SD-1.1

TITLE	SON8B-B-Carrier Tape
No.	PA008-B-C-SD-1.1
SCALE	
UNIT	mm
SII Semiconductor Corporation	

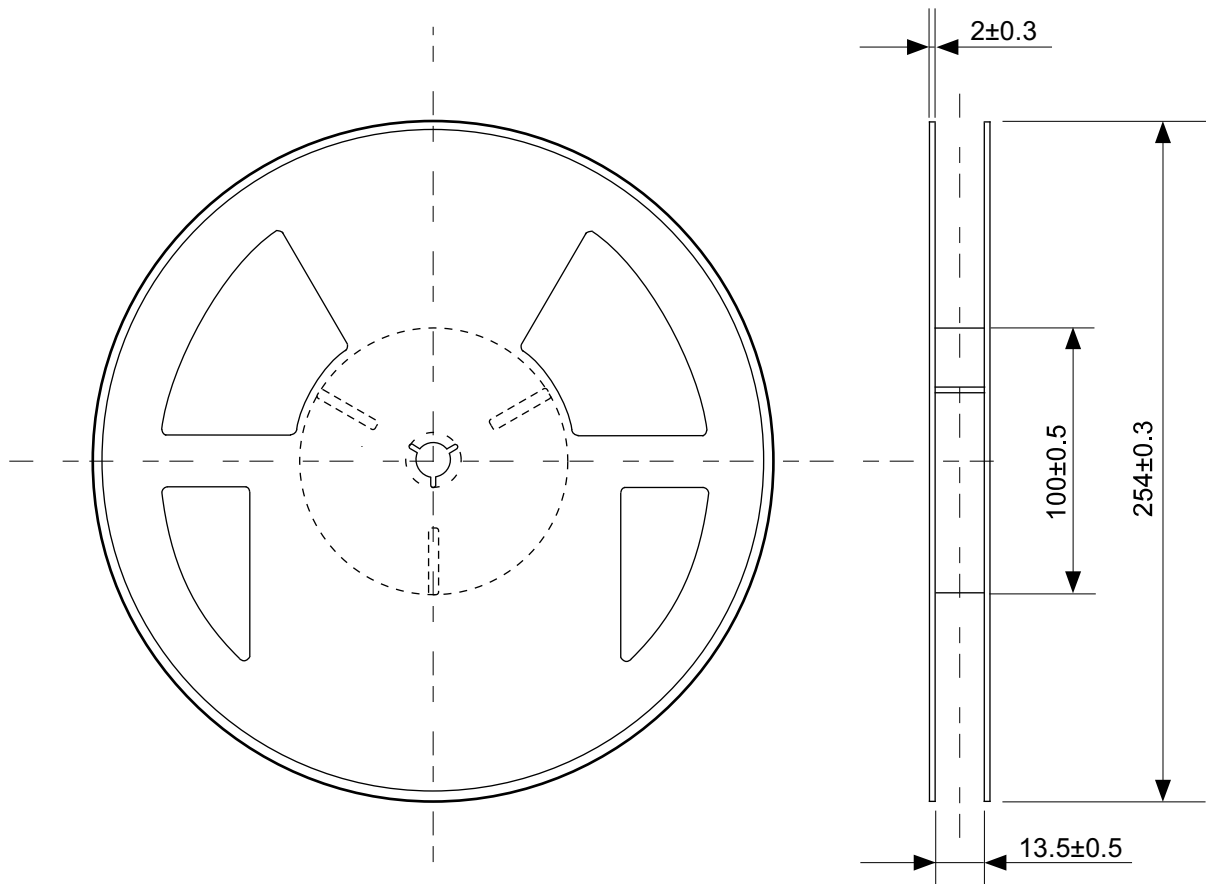

Enlarged drawing in the central part

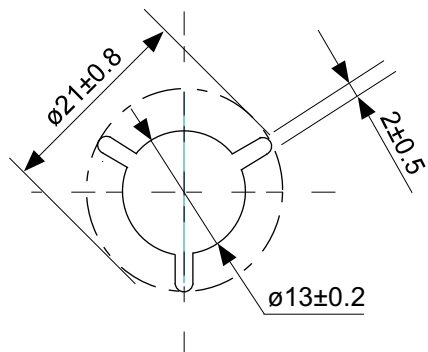

No. PA008-B-R-SD-1.1

TITLE	SON8B-B-Reel		
No.	PA008-B-R-SD-1.1		
SCALE		QTY.	3,000
UNIT	mm		
SII Semiconductor Corporation			

Disclaimers (Handling Precautions)

1. All the information described herein (product data, specifications, figures, tables, programs, algorithms and application circuit examples, etc.) is current as of publishing date of this document and is subject to change without notice.
2. The circuit examples and the usages described herein are for reference only, and do not guarantee the success of any specific mass-production design.
SII Semiconductor Corporation is not responsible for damages caused by the reasons other than the products or infringement of third-party intellectual property rights and any other rights due to the use of the information described herein.
3. SII Semiconductor Corporation is not responsible for damages caused by the incorrect information described herein.
4. Take care to use the products described herein within their specified ranges. Pay special attention to the absolute maximum ratings, operation voltage range and electrical characteristics, etc.
SII Semiconductor Corporation is not responsible for damages caused by failures and/or accidents, etc. that occur due to the use of products outside their specified ranges.
5. When using the products described herein, confirm their applications, and the laws and regulations of the region or country where they are used and verify suitability, safety and other factors for the intended use.
6. When exporting the products described herein, comply with the Foreign Exchange and Foreign Trade Act and all other export-related laws, and follow the required procedures.
7. The products described herein must not be used or provided (exported) for the purposes of the development of weapons of mass destruction or military use. SII Semiconductor Corporation is not responsible for any provision (export) to those whose purpose is to develop, manufacture, use or store nuclear, biological or chemical weapons, missiles, or other military use.
8. The products described herein are not designed to be used as part of any device or equipment that may affect the human body, human life, or assets (such as medical equipment, disaster prevention systems, security systems, combustion control systems, infrastructure control systems, vehicle equipment, traffic systems, in-vehicle equipment, aviation equipment, aerospace equipment, and nuclear-related equipment), excluding when specified for in-vehicle use or other uses. Do not use those products without the prior written permission of SII Semiconductor Corporation. Especially, the products described herein cannot be used for life support devices, devices implanted in the human body and devices that directly affect human life, etc.
Prior consultation with our sales office is required when considering the above uses.
SII Semiconductor Corporation is not responsible for damages caused by unauthorized or unspecified use of our products.
9. Semiconductor products may fail or malfunction with some probability.
The user of these products should therefore take responsibility to give thorough consideration to safety design including redundancy, fire spread prevention measures, and malfunction prevention to prevent accidents causing injury or death, fires and social damage, etc. that may ensue from the products' failure or malfunction.
The entire system must be sufficiently evaluated and applied on customer's own responsibility.
10. The products described herein are not designed to be radiation-proof. The necessary radiation measures should be taken in the product design by the customer depending on the intended use.
11. The products described herein do not affect human health under normal use. However, they contain chemical substances and heavy metals and should therefore not be put in the mouth. The fracture surfaces of wafers and chips may be sharp. Take care when handling these with the bare hands to prevent injuries, etc.
12. When disposing of the products described herein, comply with the laws and ordinances of the country or region where they are used.
13. The information described herein contains copyright information and know-how of SII Semiconductor Corporation.
The information described herein does not convey any license under any intellectual property rights or any other rights belonging to SII Semiconductor Corporation or a third party. Reproduction or copying of the information described herein for the purpose of disclosing it to a third-party without the express permission of SII Semiconductor Corporation is strictly prohibited.
14. For more details on the information described herein, contact our sales office.

1.0-2016.01



Mouser Electronics

Authorized Distributor

Click to View Pricing, Inventory, Delivery & Lifecycle Information:

Seiko Instruments:

[S-8424BAAFT-TBG](#) [S-8424AAAFT-TB-G](#) [S-8424AABFT-TB-G](#) [S-8424AACFT-TB-G](#) [S-8424AADFT-TB-G](#) [S-8424AAFFT-TB-G](#) [S-8424AAGFT-TB-G](#) [S-8424AAJFT-TB-G](#) [S-8424AAKFT-TB-G](#) [S-8424AAAPA-TF-G](#) [S-8424AAEFT-TB-G](#) [S-8424AAHFT-TB-G](#) [S-8424AAGFT-TB-U](#) [S-8424AABFT-TB-U](#) [S-8424AAHFT-TB-U](#) [S-8424AAFFT-TB-U](#) [S-8424AACFT-TB-U](#) [S-8424AAAFT-TB-U](#) [S-8424AAJFT-TB-U](#) [S-8424AADFT-TB-U](#) [S-8424AAKFT-TB-U](#)



Компания «ЭлектроПласт» предлагает заключение долгосрочных отношений при поставках импортных электронных компонентов на взаимовыгодных условиях!

Наши преимущества:

- Оперативные поставки широкого спектра электронных компонентов отечественного и импортного производства напрямую от производителей и с крупнейших мировых складов;
- Поставка более 17-ти миллионов наименований электронных компонентов;
- Поставка сложных, дефицитных, либо снятых с производства позиций;
- Оперативные сроки поставки под заказ (от 5 рабочих дней);
- Экспресс доставка в любую точку России;
- Техническая поддержка проекта, помощь в подборе аналогов, поставка прототипов;
- Система менеджмента качества сертифицирована по Международному стандарту ISO 9001;
- Лицензия ФСБ на осуществление работ с использованием сведений, составляющих государственную тайну;
- Поставка специализированных компонентов (Xilinx, Altera, Analog Devices, Intersil, Interpoint, Microsemi, Aeroflex, Peregrine, Syfer, Eurofarad, Texas Instrument, Miteq, Cobham, E2V, MA-COM, Hittite, Mini-Circuits, General Dynamics и др.);

Помимо этого, одним из направлений компании «ЭлектроПласт» является направление «Источники питания». Мы предлагаем Вам помощь Конструкторского отдела:

- Подбор оптимального решения, техническое обоснование при выборе компонента;
- Подбор аналогов;
- Консультации по применению компонента;
- Поставка образцов и прототипов;
- Техническая поддержка проекта;
- Защита от снятия компонента с производства.



Как с нами связаться

Телефон: 8 (812) 309 58 32 (многоканальный)

Факс: 8 (812) 320-02-42

Электронная почта: org@eplast1.ru

Адрес: 198099, г. Санкт-Петербург, ул. Калинина, дом 2, корпус 4, литера А.