

HIGH POWER SPDT SWITCH GaAs MMIC

■ GENERAL DESCRIPTION

The NJG1681MD7 is a GaAs SPDT switch MMIC suitable for LTE/UMTS/CDMA/GSM applications.

The NJG1681MD7 features very low insertion loss, high isolation and excellent linearity performance down to 1.8V control voltage at high frequency up to 6GHz. In addition, this switch is able to handle high power signals.

The NJG1681MD7 has ESD protection devices to achieve excellent ESD performances. No DC Blocking capacitors are required for all RF ports unless DC is biased externally. And the ultra small & ultra thin EQFN14-D7 package is adopted.

■ PACKAGE OUTLINE

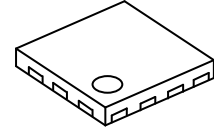

NJG1681MD7

■ APPLICATIONS

LTE, UMTS, CDMA, GSM applications

Post PA switching, antenna switching, bands switching, and general purpose switching applications

IEEE 802.11p applications

■ FEATURES

- Low voltage logic control
- Low voltage operation
- Low distortion

- High linearity
- Low insertion loss

- Ultra small & ultra thin package
- RoHS compliant and Halogen Free, MSL1

$V_{CTL(H)}=1.8V$ typ.

$V_{DD}=2.7V$ typ.

IIP3=+73dBm typ. @f=829+849MHz, $P_{IN}=24dBm$

IIP3=+71dBm typ. @f=1870+1910MHz, $P_{IN}=24dBm$

2nd harmonics=-85dBc typ. @ f=0.9GHz, $P_{IN}=35dBm$

3rd harmonics=-90dBc typ. @ f=0.9GHz, $P_{IN}=35dBm$

P-0.1dB=+36dBm min.

0.18dB typ. @f=0.9GHz, $P_{IN}=35dBm$

0.20dB typ. @f=1.9GHz, $P_{IN}=33dBm$

0.23dB typ. @f=2.7GHz, $P_{IN}=27dBm$

EQFN14-D7 (Package size: 1.6 x 1.6 x 0.397mm.)

■ PIN CONFIGURATION

(TOP VIEW)

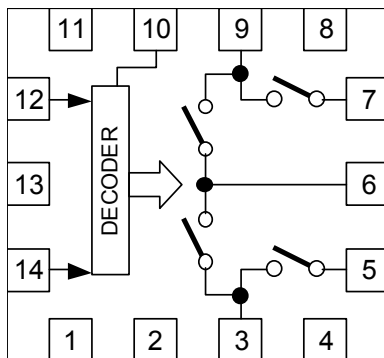

Pin connection

1. GND	8. GND
2. NC(GND)	9. P1
3. P2	10. GND
4. GND	11. GND
5. GND	12. VDD
6. PC	13. NC(GND)
7. GND	14. VCTL

Exposed PAD: GND

■ TRUTH TABLE

"H"= $V_{CTL(H)}$, "L"= $V_{CTL(L)}$	
VCTL	Path
H	PC-P1
L	PC-P2

NOTE: Please note that any information on this datasheet will be subject to change.

■ ABSOLUTE MAXIMUM RATINGS

($T_a=+25^{\circ}\text{C}$, $Z_s=Z_i=50\Omega$)

PARAMETER	SYMBOL	CONDITIONS	RATINGS	UNITS
RF Input Power	P_{IN}	$V_{DD}=2.7\text{V}$	37	dBm
Supply Voltage	V_{DD}		5.0	V
Control Voltage	V_{CTL}		5.0	V
Power Dissipation	P_D	Four-layer FR4 PCB with through-hole (74.2x74.2mm), $T_j=150^{\circ}\text{C}$	1300	mW
Operating Temp.	T_{opr}		-40~+85	$^{\circ}\text{C}$
Storage Temp.	T_{stg}		-55~+150	$^{\circ}\text{C}$

■ ELECTRICAL CHARACTERISTICS 1 (DC)

(General conditions: $T_a=+25^{\circ}\text{C}$, $V_{DD}=2.7\text{V}$, $V_{CTL(L)}=0\text{V}$, $V_{CTL(H)}=1.8\text{V}$)

PARAMETERS	SYMBOL	CONDITIONS	MIN	TYP	MAX	UNITS
Supply Voltage	V_{DD}		2.375	2.7	5.0	V
Operating Current	I_{DD}	No RF input, $V_{DD}=2.7\text{V}$	-	95	180	μA
Control Voltage (LOW)	$V_{CTL(L)}$		0	-	0.45	V
Control Voltage (HIGH)	$V_{CTL(H)}$		1.35	1.8	5.0	V
Control Current	I_{CTL}	$V_{CTL(H)}=1.8\text{V}$	-	4	10	μA

■ ELECTRICAL CHARACTERISTICS 2 (RF)

(General conditions: $T_a=+25^{\circ}\text{C}$, $Z_s=Z_l=50\Omega$, $V_{DD}=2.7\text{V}$, $V_{CTL(L)}=0\text{V}$, $V_{CTL(H)}=1.8\text{V}$)

PARAMETERS	SYMBOL	CONDITIONS	MIN	TYP	MAX	UNITS
Insertion Loss 1	LOSS1	f=0.9GHz, $P_{IN}=35\text{dBm}$	-	0.18	0.33	dB
Insertion Loss 2	LOSS2	f=1.9GHz, $P_{IN}=33\text{dBm}$	-	0.20	0.40	dB
Insertion Loss 3	LOSS3	f=2.7GHz, $P_{IN}=27\text{dBm}$	-	0.23	0.43	dB
Insertion Loss 4	LOSS4	f=6.0GHz, $P_{IN}=27\text{dBm}$	-	0.45	0.65	dB
Isolation 1	ISL1	f=0.9GHz, $P_{IN}=35\text{dBm}$	40	45	-	dB
Isolation 2	ISL2	f=1.9GHz, $P_{IN}=33\text{dBm}$	30	35	-	dB
Isolation 3	ISL3	f=2.7GHz, $P_{IN}=27\text{dBm}$	25	30	-	dB
Isolation 4	ISL4	f=6.0GHz, $P_{IN}=27\text{dBm}$	16.5	20	-	dB
Input Power at 0.1dB Compression Point1	$P_{-0.1\text{dB}1}$	f=0.9GHz, 1.9GHz, 2.7GHz	+36	-	-	dBm
Input Power at 0.1dB Compression Point2	$P_{-0.1\text{dB}2}$	f=6.0GHz	+36	-	-	dBm
2nd Harmonics 1	2fo(1)	f=0.9GHz, $P_{IN}=35\text{dBm}$	-	-85	-70	dBc
2nd Harmonics 2	2fo(2)	f=1.9GHz, $P_{IN}=33\text{dBm}$	-	-90	-70	dBc
2nd Harmonics 3	2fo(3)	f=2.7GHz, $P_{IN}=27\text{dBm}$	-	-90	-70	dBc
3rd Harmonics 1	3fo(1)	f=0.9GHz, $P_{IN}=35\text{dBm}$	-	-90	-70	dBc
3rd Harmonics 2	3fo(2)	f=1.9GHz, $P_{IN}=33\text{dBm}$	-	-80	-70	dBc
3rd Harmonics 3	3fo(3)	f=2.7GHz, $P_{IN}=27\text{dBm}$	-	-90	-70	dBc
Input 3 rd order intercept point1	IIP3(1)	f=829+849MHz, $P_{IN}=24\text{dBm}$ each	+65	+73	-	dBm
Input 3 rd order intercept point2	IIP3(2)	f=1870+1910MHz, $P_{IN}=24\text{dBm}$ each	+65	+71	-	dBm
VSWR1	VSWR1	on-state ports, f=2.7GHz	-	1.1	1.4	
VSWR2	VSWR2	on-state ports, f=6.0GHz	-	1.1	1.4	
Switching time	T_{SW}	50% V_{CTL} to 10/90% RF	-	1	5	μs

*1: IIP3 are defined by the following equations.

$$\text{IIP3}=(3 \times \text{Pout-IM3})/2+\text{LOSS}$$

■ TERMINAL INFORMATION

No.	SYMBOL	DESCRIPTION
1	GND	Ground terminal. Please connect this terminal with ground plane as close as possible for excellent RF performance.
2	NC(GND)	Ground terminal. Please connect this terminal with ground plane as close as possible for excellent RF performance.
3	P2	RF transmitting/receiving port. No DC blocking capacitor is required for this port unless DC is biased externally.
4	GND	Ground terminal. Please connect this terminal with ground plane as close as possible for excellent RF performance.
5	GND	Ground terminal. Please connect this terminal with ground plane as close as possible for excellent RF performance.
6	PC	RF transmitting/receiving port. No DC blocking capacitor is required for this port unless DC is biased externally. Please connect an inductor with GND terminal for ESD protection.
7	GND	Ground terminal. Please connect this terminal with ground plane as close as possible for excellent RF performance.
8	GND	Ground terminal. Please connect this terminal with ground plane as close as possible for excellent RF performance.
9	P1	RF transmitting/receiving port. No DC blocking capacitor is required for this port unless DC is biased externally.
10	GND	Ground terminal. Please connect this terminal with ground plane as close as possible for excellent RF performance.
11	GND	Ground terminal. Please connect this terminal with ground plane as close as possible for excellent RF performance.
12	VDD	Positive voltage supply terminal. The positive voltage (+2.375~+5V) has to be supplied. Please connect a bypass capacitor with GND terminal for excellent RF performance.
13	NC(GND)	Ground terminal. Please connect this terminal with ground plane as close as possible for excellent RF performance.
14	VCTL	Control signal input terminal. This terminal is set to High-Level (+1.35~+5.0V) or Low-Level (0~+0.45V).
Exposed Pad	GND	Ground terminal.

■ ELECTRICAL CHARACTERISTICS (With application circuit)

Loss, ISL vs Frequency

(PC-P1 ON, $V_{DD}=2.7V$, $V_{CTL}=1.8V$)
(Losses of external circuits are excluded)

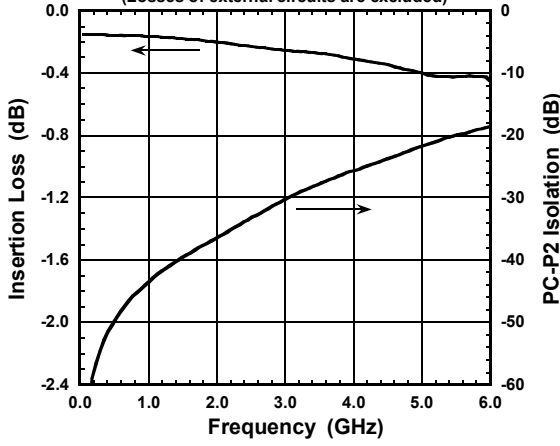

Loss, ISL vs Frequency

(PC-P2 ON, $V_{DD}=2.7V$, $V_{CTL}=0V$)
(Losses of external circuits are excluded)

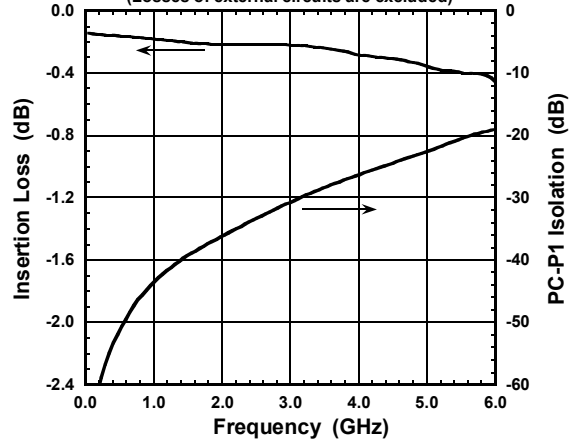

VSWR vs Frequency

(PC-P1 ON, $V_{DD}=2.7V$, $V_{CTL}=1.8V$)

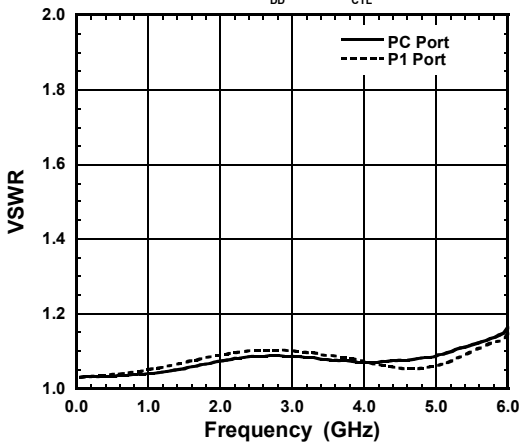

VSWR vs Frequency

(PC-P2 ON, $V_{DD}=2.7V$, $V_{CTL}=0V$)

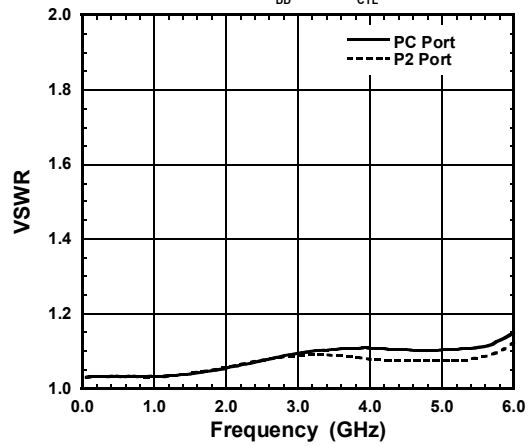

IDD vs. VDD

(No RF input, PC-P1 ON, $V_{CTL}=1.8V$)

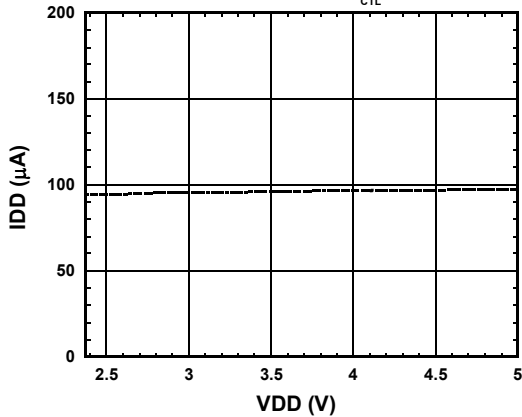

Control Current vs. VCTL

(No RF input, PC-P1 ON, $V_{DD}=2.7V$)

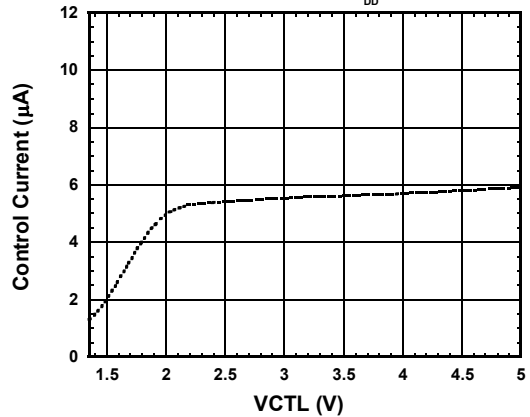

■ ELECTRICAL CHARACTERISTICS (With application circuit)

Output Power, I_{DD} vs Input Power

($f=0.9\text{GHz}$, PC-P1 ON, $V_{CTL}=1.8\text{V}$)
(Losses of external circuits are excluded)

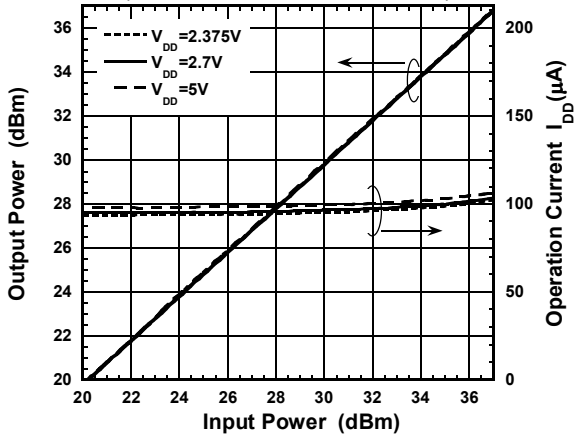

Output Power, I_{DD} vs Input Power

($f=1.9\text{GHz}$, PC-P1 ON, $V_{CTL}=1.8\text{V}$)
(Losses of external circuits are excluded)

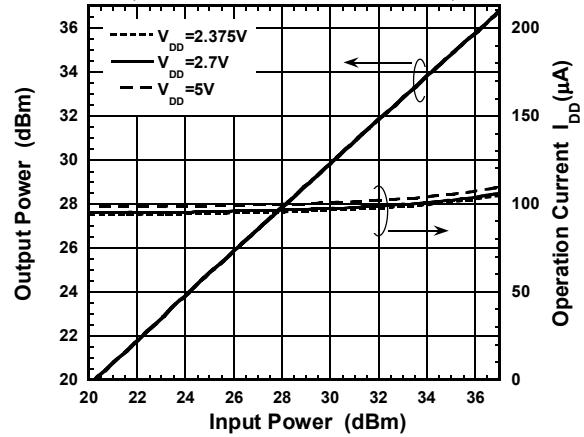

Output Power, I_{DD} vs Input Power

($f=2.7\text{GHz}$, PC-P1 ON, $V_{CTL}=1.8\text{V}$)
(Losses of external circuits are excluded)

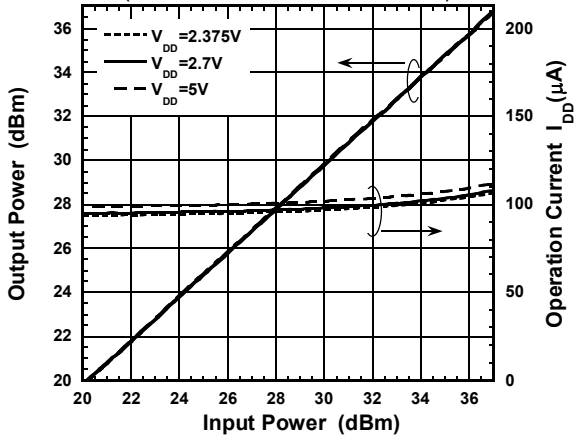

Loss, ISL vs Input Power

($f=0.9\text{GHz}$, PC-P1 ON, $V_{CTL}=1.8\text{V}$)
(Losses of external circuits are excluded)

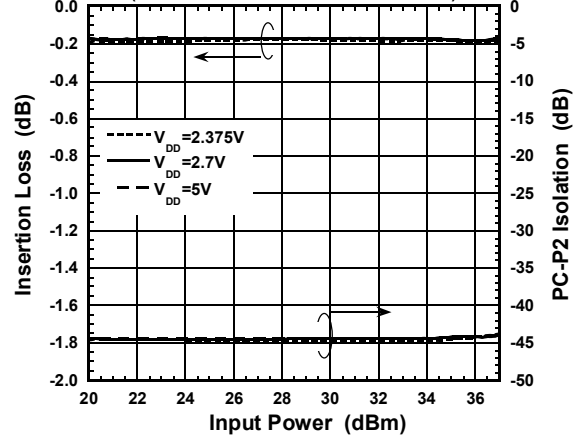

Loss, ISL vs Input Power

($f=1.9\text{GHz}$, PC-P1 ON, $V_{CTL}=1.8\text{V}$)
(Losses of external circuits are excluded)

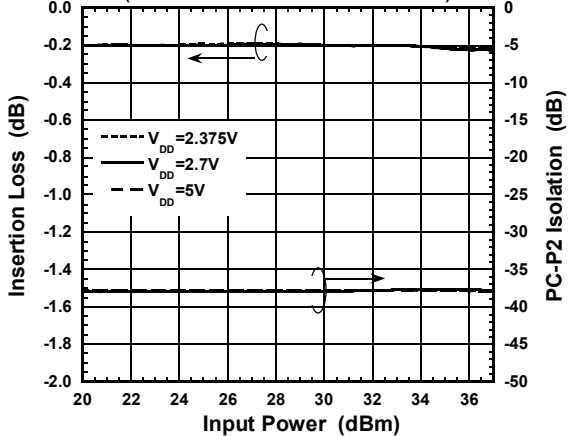

Loss, ISL vs Input Power

($f=2.7\text{GHz}$, PC-P1 ON, $V_{CTL}=1.8\text{V}$)
(Losses of external circuits are excluded)

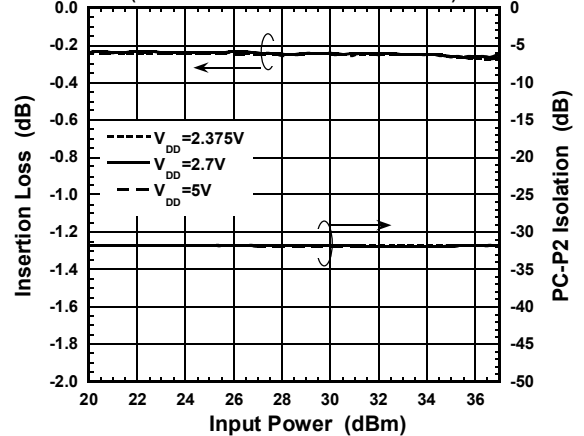

ELECTRICAL CHARACTERISTICS (With application circuit)

Loss, ISL vs Ambient Temperature

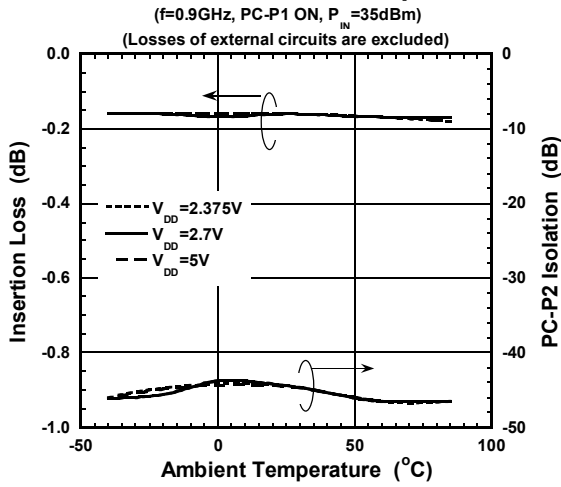

Loss, ISL vs Ambient Temperature

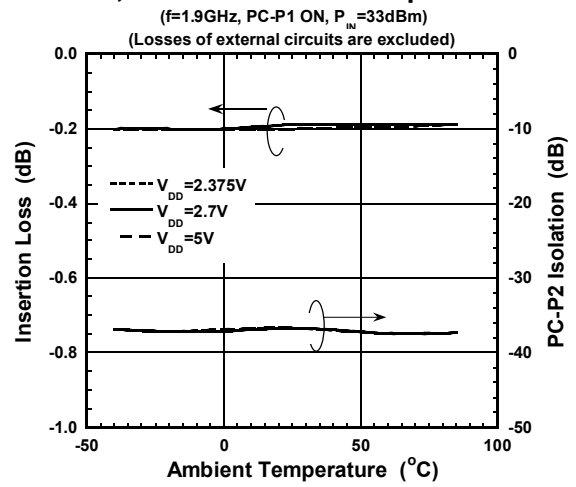

Loss, ISL vs Ambient Temperature

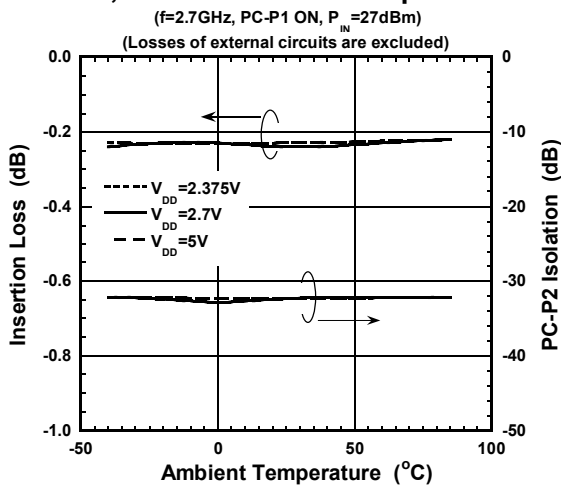

DC Current vs Ambient Temperature

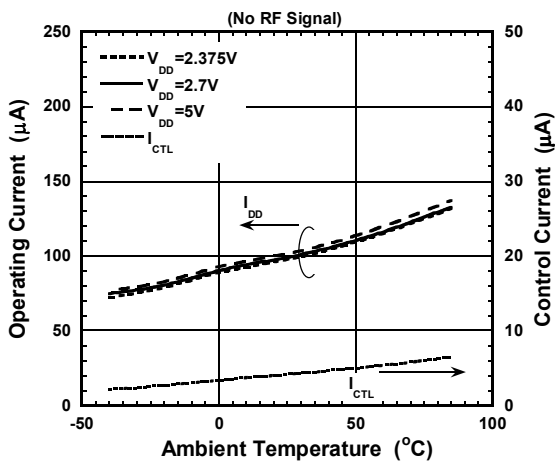

Switching Time vs Ambient Temperature

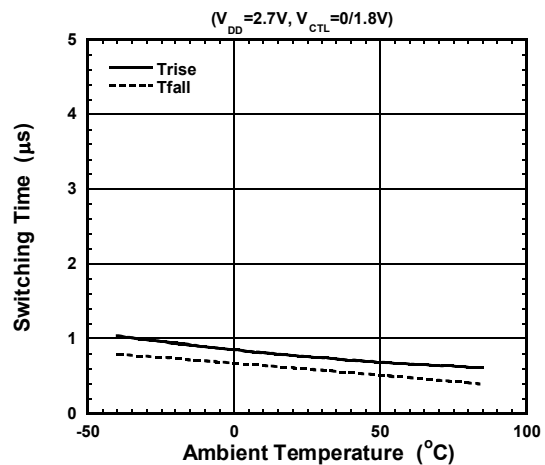

APPLICATION CIRCUIT

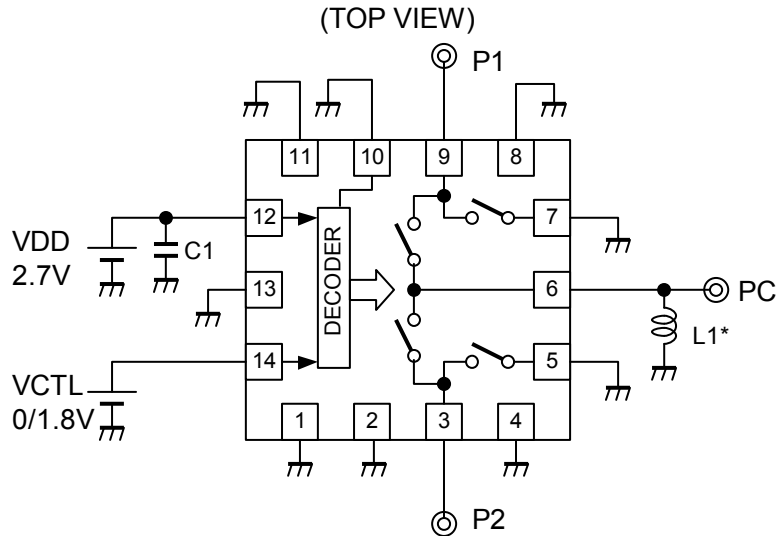

Note: No DC blocking capacitors are required on all RF ports, unless DC is biased externally.

- * The Inductor L1 is required for enhancing ESD protection level.
The inductor L1 is recommended in order to keep the DC bias level of each RF port at 0 V level tightly.

PARTS LIST

No.	Parameters	Note
C1	1000pF	MURATA (GRM15)
L1	68nH	TAIYO-YUDEN (HK1005)

PCB LAYOUT

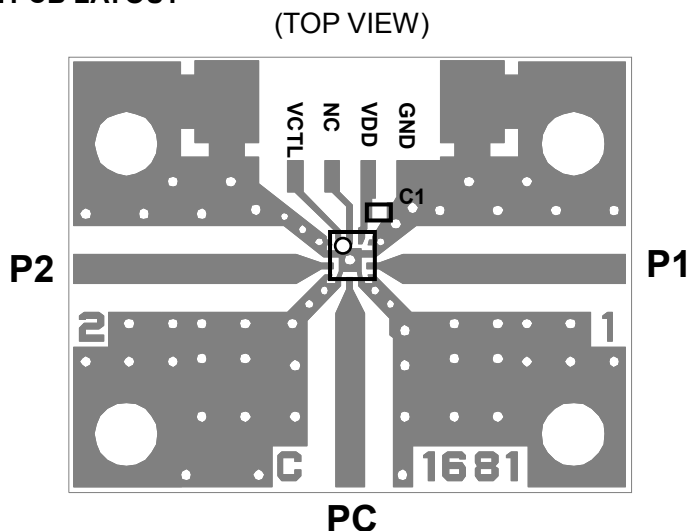

PCB SIZE: 19.4 x 15.0 mm
PCB: FR-4, t=0.5mm
Capacitor size: 1005
MICROSTRIP LINE WIDTH: 0.98mm



Losses of PCB and connectors, Ta=+25°C

Frequency (GHz)	Loss (dB)
0.9	0.09
1.9	0.18
2.7	0.26
6.0	0.48

PRECAUTIONS

- [1] No DC blocking capacitors are required at each RF port normally. When the other device is biased at certain voltage and connected to the NJG1681MD7, a DC block capacitor is required between the device and the switch IC. This is because the each RF port of NJG1681MD7 is biased at 0 V (GND).
- [2] For avoiding the degradation of RF performance, the bypass capacitor (C1) should be placed as close as possible to VDD terminal
- [3] For good RF performance, all GND terminals are must be connected to PCB ground plane of substrate, and through - holes for GND should be placed the IC near.

RECOMMENDED FOOTPRINT PATTERN (EQFN14-D7 PACKAGE Reference)

-  : Land
-  : Mask (Open area) *Metal mask thickness : 100μm
-  : Resist(Open area)

PKG: 1.6mm x 1.6mm
Pin pitch: 0.4mm

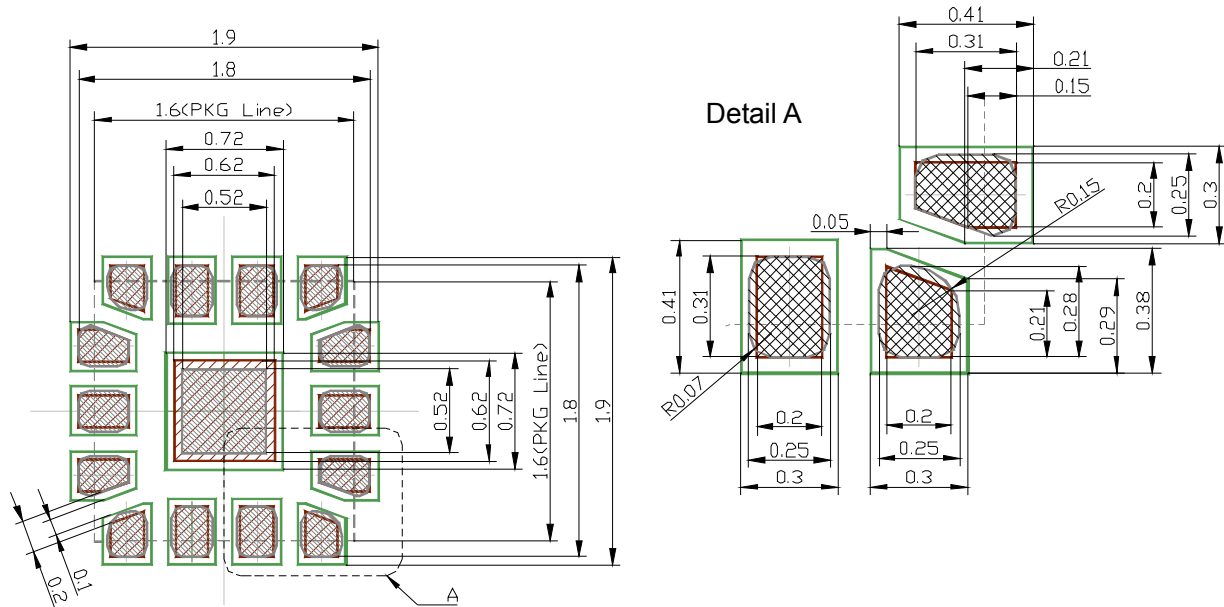

■ PACKAGE OUTLINE (EQFN14-D7)

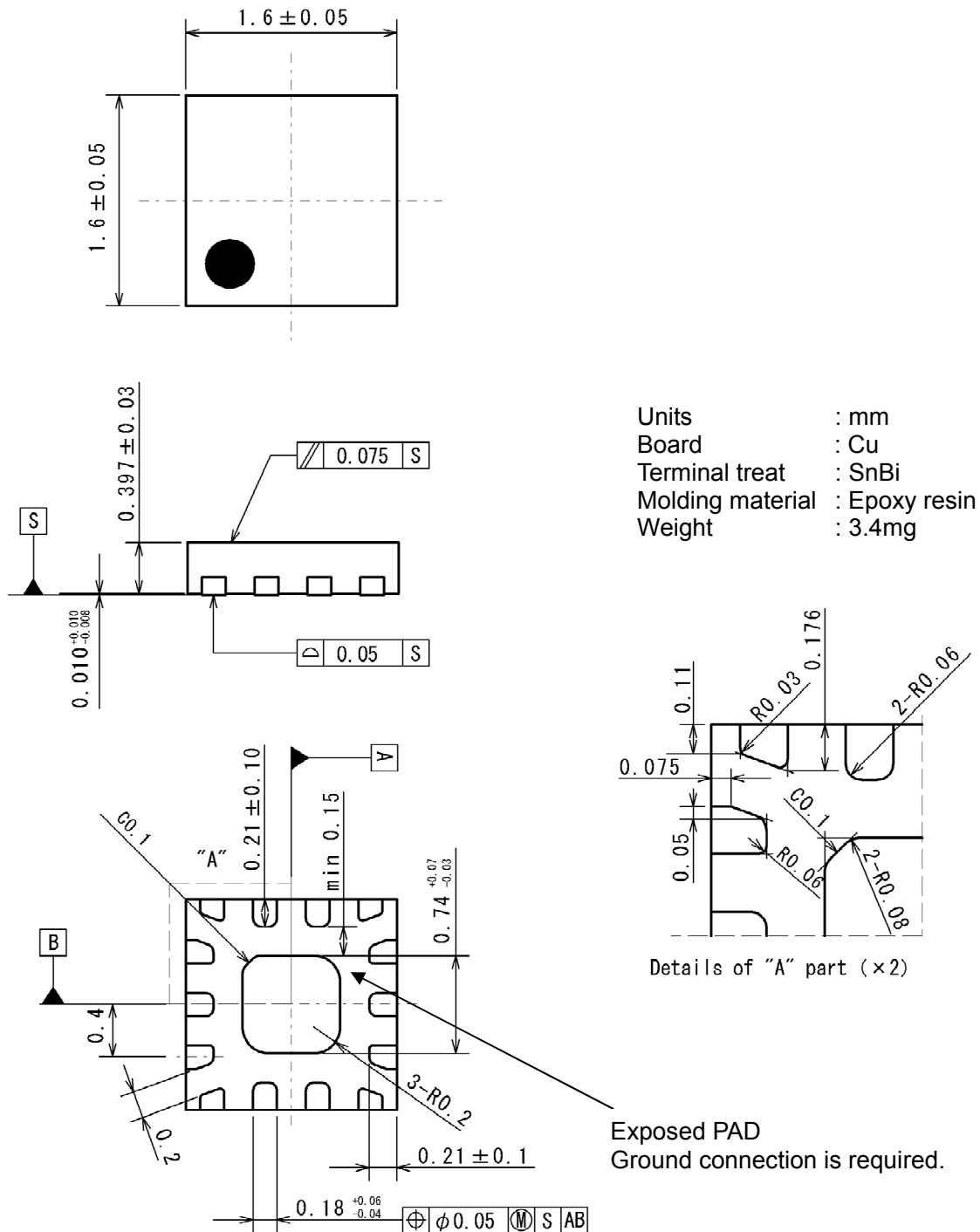

Cautions on using this product

This product contains Gallium-Arsenide (GaAs) which is a harmful material.

- Do NOT eat or put into mouth.
- Do NOT dispose in fire or break up this product.
- Do NOT chemically make gas or powder with this product.
- To waste this product, please obey the relating law of your country.

[CAUTION]

The specifications on this databook are only given for information, without any guarantee as regards either mistakes or omissions. The application circuits in this databook are described only to show representative usages of the product and not intended for the guarantee or permission of any right including the industrial rights.

This product may be damaged with electric static discharge (ESD) or spike voltage. Please handle with care to avoid these damages.

Mouser Electronics

Authorized Distributor

Click to View Pricing, Inventory, Delivery & Lifecycle Information:

[NJR:](#)

[NJG1681MD7](#)



Компания «ЭлектроПласт» предлагает заключение долгосрочных отношений при поставках импортных электронных компонентов на взаимовыгодных условиях!

Наши преимущества:

- Оперативные поставки широкого спектра электронных компонентов отечественного и импортного производства напрямую от производителей и с крупнейших мировых складов;
- Поставка более 17-ти миллионов наименований электронных компонентов;
- Поставка сложных, дефицитных, либо снятых с производства позиций;
- Оперативные сроки поставки под заказ (от 5 рабочих дней);
- Экспресс доставка в любую точку России;
- Техническая поддержка проекта, помощь в подборе аналогов, поставка прототипов;
- Система менеджмента качества сертифицирована по Международному стандарту ISO 9001;
- Лицензия ФСБ на осуществление работ с использованием сведений, составляющих государственную тайну;
- Поставка специализированных компонентов (Xilinx, Altera, Analog Devices, Intersil, Interpoint, Microsemi, Aeroflex, Peregrine, Syfer, Eurofarad, Texas Instrument, Miteq, Cobham, E2V, MA-COM, Hittite, Mini-Circuits, General Dynamics и др.);

Помимо этого, одним из направлений компании «ЭлектроПласт» является направление «Источники питания». Мы предлагаем Вам помощь Конструкторского отдела:

- Подбор оптимального решения, техническое обоснование при выборе компонента;
- Подбор аналогов;
- Консультации по применению компонента;
- Поставка образцов и прототипов;
- Техническая поддержка проекта;
- Защита от снятия компонента с производства.



Как с нами связаться

Телефон: 8 (812) 309 58 32 (многоканальный)

Факс: 8 (812) 320-02-42

Электронная почта: org@eplast1.ru

Адрес: 198099, г. Санкт-Петербург, ул. Калинина, дом 2, корпус 4, литера А.