

# **V600 RFID System**

## **R/W Heads and SRAM Data Carriers**

# **OPERATION MANUAL**

**OMRON**

# V600 RFID System

## R/W Heads and SRAM Data Carriers

### Operation Manual

*Produced August 1998*

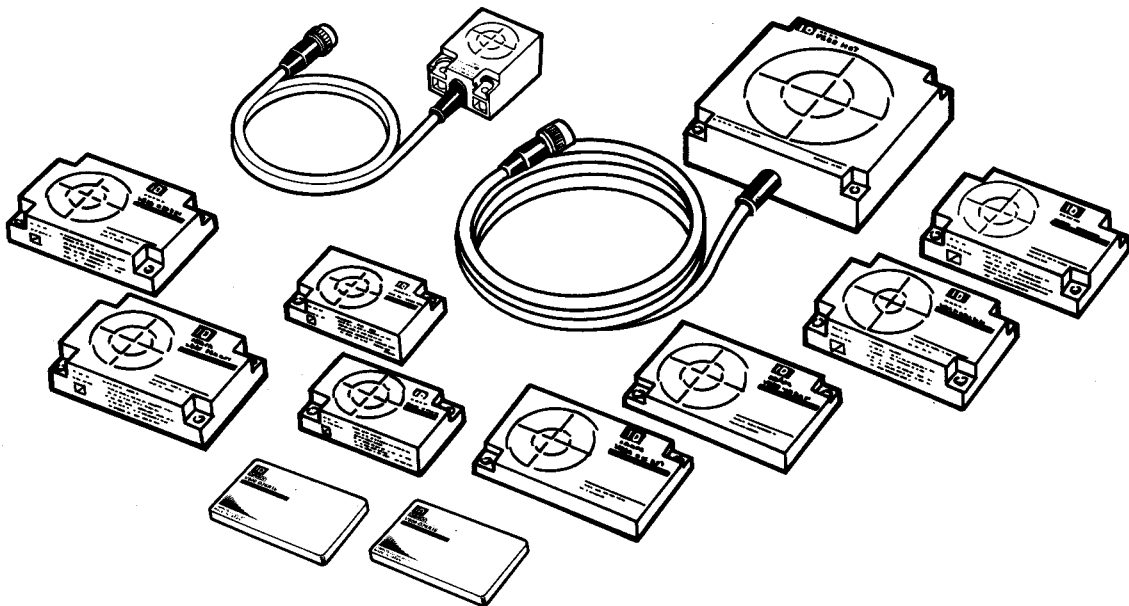



## Notice:

OMRON products are manufactured for use according to proper procedures by a qualified operator and only for the purposes described in this manual.

The following conventions are used to indicate and classify precautions in this manual. Always heed the information provided with them. Failure to heed precautions can result in injury to people or damage to property.

 **DANGER** Indicates an imminently hazardous situation which, if not avoided, will result in death or serious injury.

 **WARNING** Indicates a potentially hazardous situation which, if not avoided, could result in death or serious injury.

 **Caution** Indicates a potentially hazardous situation which, if not avoided, may result in minor or moderate injury, or property damage.

## Product Application

You must allow sufficient leeway against product ratings and functionality, and provide safety measures, such as fail-safe measures, whenever applying the products described in this manual in any of the following situations. Always consult with your OMRON representative whenever applying the products in any of these situations.

- Applications under any conditions or any environments not described in this manual.
- Applications for nuclear power control, railways, aviation, automobiles, furnaces, medical equipment, amusement equipment, safety equipment, etc.
- Applications that can affect human life or property or that particularly require safety.

## Visual Aids

The following headings appear in the left column of the manual to help you locate different types of information.

**Note** Indicates information of particular interest for efficient and convenient operation of the product.

**1, 2, 3...** 1. Indicates lists of one sort or another, such as procedures, checklists, etc.

## © OMRON, 1998

All rights reserved. No part of this publication may be reproduced, stored in a retrieval system, or transmitted, in any form, or by any means, mechanical, electronic, photocopying, recording, or otherwise, without the prior written permission of OMRON.

No patent liability is assumed with respect to the use of the information contained herein. Moreover, because OMRON is constantly striving to improve its high-quality products, the information contained in this manual is subject to change without notice. Every precaution has been taken in the preparation of this manual. Nevertheless, OMRON assumes no responsibility for errors or omissions. Neither is any liability assumed for damages resulting from the use of the information contained in this publication.

# TABLE OF CONTENTS

<b>SECTION 1</b>	
<b>Features and System Configuration</b> .....	<b>1</b>
1-1 Features .....	2
1-2 System Configuration .....	3
<b>SECTION 2</b>	
<b>Specifications</b> .....	<b>5</b>
2-1 R/W Heads .....	6
2-2 Data Carriers .....	8
2-3 Data Carrier Battery Service Life .....	12
<b>SECTION 3</b>	
<b>Communications Specifications</b> .....	<b>15</b>
3-1 Transmission Range .....	16
3-2 Transmission Time .....	17
3-3 Data Carrier Speed .....	19
<b>SECTION 4</b>	
<b>Installation</b> .....	<b>21</b>
4-1 R/W Head Installation .....	22
4-2 Data Carrier Installation .....	26
<b>SECTION 5</b>	
<b>Chemical Resistance</b> .....	<b>31</b>
<b>Appendices</b>	
A Accessories (Sold Separately) .....	33
B Discontinued Models and Replacements .....	35
C Other Series .....	49
<b>Revision History</b> .....	<b>51</b>

## ***About this Manual:***

This manual describes the installation and operation of the V600-series Read/Write Heads and battery-powered SRAM Data Carriers, and includes the sections described below.

Please read this manual carefully and be sure you understand the information provided before attempting to install and operate the Read/Write Heads and Data Carriers. Keep this manual in a convenient location where it can continue to be used for reference and guidance.

**Section 1** provides general information on features and system configuration.

**Section 2** provides specifications for the Read/Write Heads and Data Carriers.

**Section 3** provides communications specifications.

**Section 4** explains how to install the Read/Write Heads and Data Carriers.

**Section 5** provides information on specific chemicals that affect the Read/Write Heads and Data Carriers.

**Appendix A** provides information on accessories that can be purchased separately.

**Appendix B** provides information on discontinued models and their replacements.

**Appendix C** provides information on particular models to be used in England.

 **WARNING** Failure to read and understand the information provided in this manual may result in personal injury or death, damage to the product, or product failure. Please read each section in its entirety and be sure you understand the information provided in the section and related sections before attempting any of the procedures or operations given.

# SECTION 1

## Features and System Configuration

This section provides a general introduction to the V600 RFID System, including the V600-series Read/Write (R/W) Heads and Data Carriers. The V600 RFID System utilizes non-contact data transfer in which data is transmitted electromagnetically without physical contact between the devices.

1-1	Features .....	2
1-2	System Configuration .....	3

## 1-1 Features

The V600 RFID System offers powerful support to the automation of large-scale distributed control systems and multi-model small-scale production systems by means of contactless data communication.

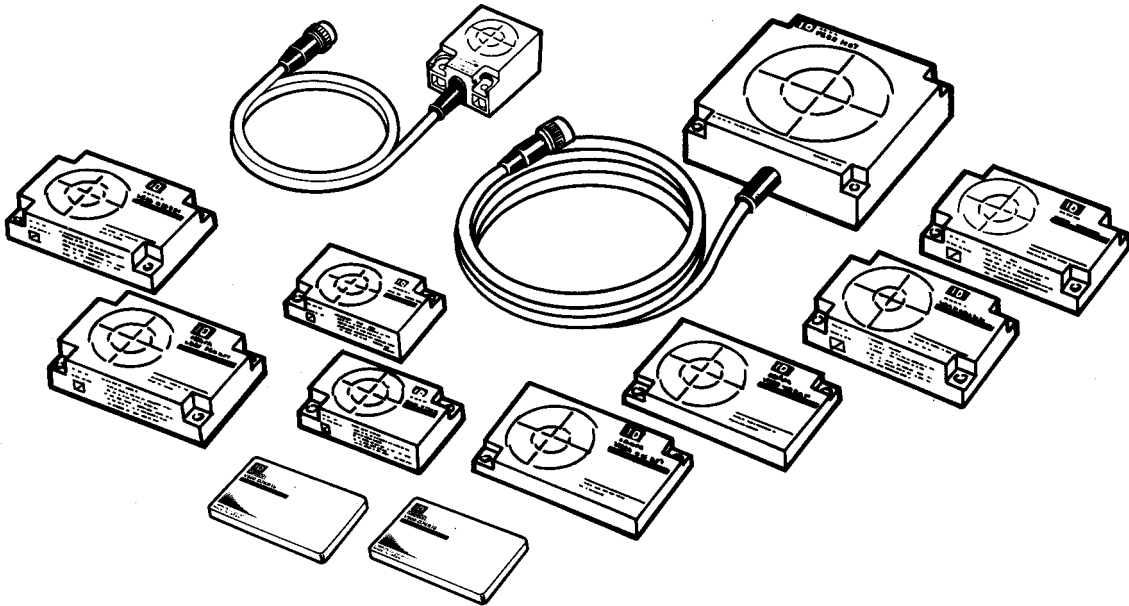

### Contactless Data Transfer

Data is transmitted between the Data Carrier (DC) and Read/Write (R/W) Head electromagnetically in both directions, without physical contact between the two devices.

### SRAM Memory

SRAM (static random access memory) is used for the DC's memory. There is no limit to the number of times that the memory can be accessed for reading or writing data. The memory is powered by a long-life lithium battery.

### CRC Error Detection

A 16-bit CRC (Cyclic Redundancy Check) has been added to detect data transmission errors in both directions between the ID Controller and R/W Head, and the R/W Head and DC. This feature also helps to ensure superior transmission reliability even in environments where noise tends to occur.

### 8K-byte Memory

The DCs have an 8K-byte memory. In addition to essential identification data, information on models and test results can be entered on-site.

### Long Battery Life

The battery will last eight years in temperatures ranging from  $-25^{\circ}\text{C}$  to  $70^{\circ}\text{C}$  ( $-18^{\circ}\text{F}$  to  $158^{\circ}\text{F}$ ).

### Battery Status Checking

The projected battery service life can be easily checked by means of a command from the ID Controller, which simplifies battery maintenance.

### Superior Durability and High Reliability

The R/W Head and DC offer superior resistance to environmental factors such as vibration, oil, water, and so on.

# 1-2 System Configuration

A V600 RFID System is made up of ID Controllers, R/W Heads, and DCs. A system can be assembled to suit almost any situation with different arrangements of these components.

## ID Controllers and ID Sensor Units

V600-CA1A/CA2A

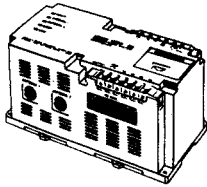

100 to 240 VAC  
Host: RS-232C/RS-422

V600-CA8A/CA9A

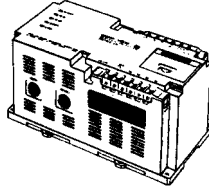

100 to 240 VAC  
Host: Parallel PNP/NPN

V600-CF1A

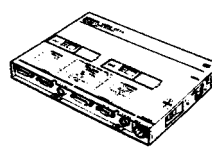

100 to 240 VAC  
Host: RS-232C

V600-CB-S

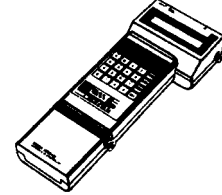

Hand-held Model

V600-CD1D-V2

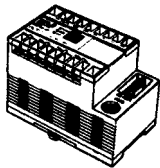

24 VDC  
Host: RS-232C

C500-IDS01-V2  
C200H-IDS01-V1

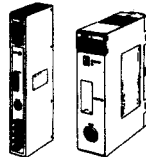

PLC, ID Sensor Units

IDSC-C1DR-A  
IDSC-C1DT-A

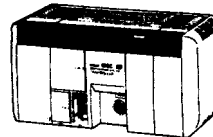

ID Controllers

## R/W Heads and Data Carriers

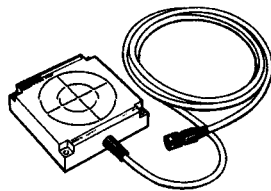

V600-H07

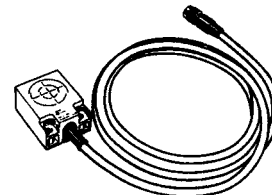

V600-H11

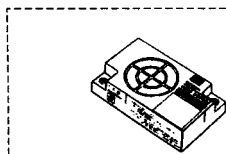

V600-D8KR12



V600-D8KR13

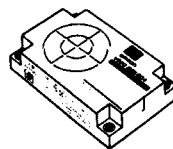

V600-D8KR04



V600-D2KR16

**Note** Refer to Appendix B for details on the availability of V600-H12 and V600-D8KR11.



# SECTION 2

## Specifications

This section provides Read/Write (R/W) Head and Data Carrier (DC) specifications.

2-1	R/W Heads .....	6
2-1-1	Specifications and Outer Dimensions .....	6
2-2	Data Carriers .....	8
2-2-1	Specifications and Outer Dimensions .....	8
2-2-2	Memory Map .....	10
2-2-3	Write Protect Function .....	10
2-3	Data Carrier Battery Service Life .....	12
2-3-1	Battery Service Life Factors .....	12
2-3-2	Battery Service Life Expectancy Check .....	14

## 2-1 R/W Heads

### 2-1-1 Specifications and Outer Dimensions

#### V600-H07/V600-H11

Item	Model	
	V600-H07	V600-H11
Operating frequency	530 kHz	
Operating temperature	-25°C to 70°C	-10°C to 60°C
Storage temperature	-40°C to 85°C	-25°C to 75°C
Operating humidity	35% to 95% RH	
Insulation resistance	50 MΩ min. between cable terminals and case (at 500 VDC)	
Dielectric strength	1,000 VAC 50/60 Hz for 1 minute between cable terminals and case.	
Degree of protection (See note.)	Meets or exceeds IEC60529 IP67 and JEM IP67G standards.	
Vibration resistance	10 to 500 Hz, 1.0 mm in each direction; acceleration: 150 m/s <sup>2</sup> (about 15 G); one sweep in each of three axis directions, three sweeps in 11 minutes	
Shock resistance	500 m/s <sup>2</sup> (about 50 G) three times each in X, Y, Z directions, total 18 times	
Error detection	16-bit CRC (Cyclic Redundancy Check) is used in both directions of transmission.	
LED indicators	Power supply: green; communications: orange	
Cable length	Standard lengths of 0.5, 2, 5, and 10 m.	
Max. cable length	30.5 m	50.5 m
Weight (approximate)	1 kg (with 10 m cable)	650 g (with 10 m cable)

**Note** The connectors are not waterproof.

#### V600-H07

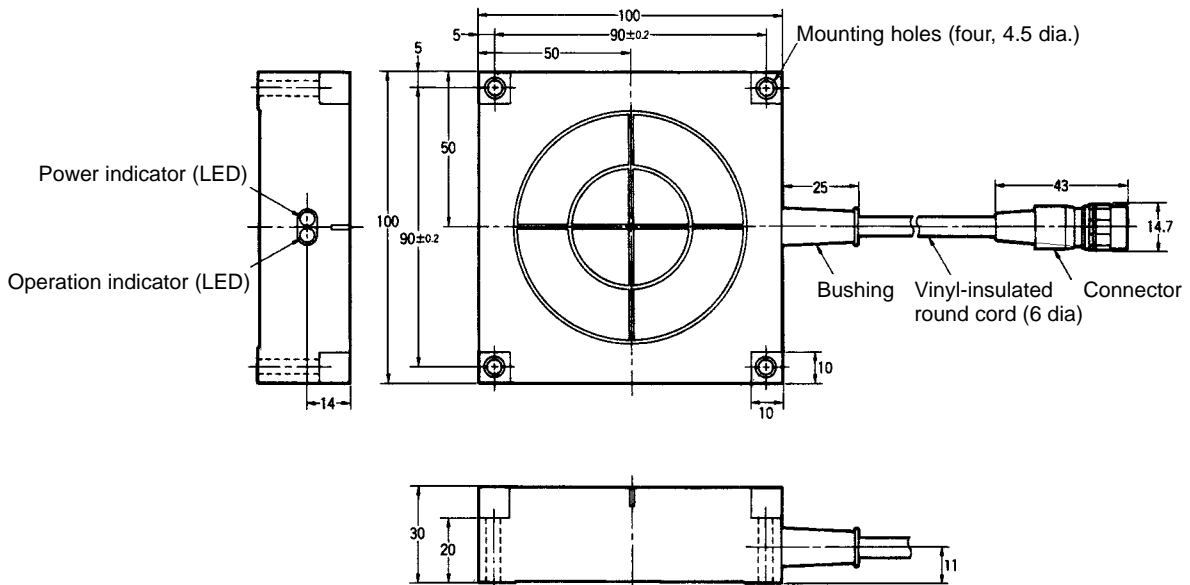

Case material	ABS resin
Fill resin	Epoxy resin
Cable	PVC (oil-resistant)

V600-H11

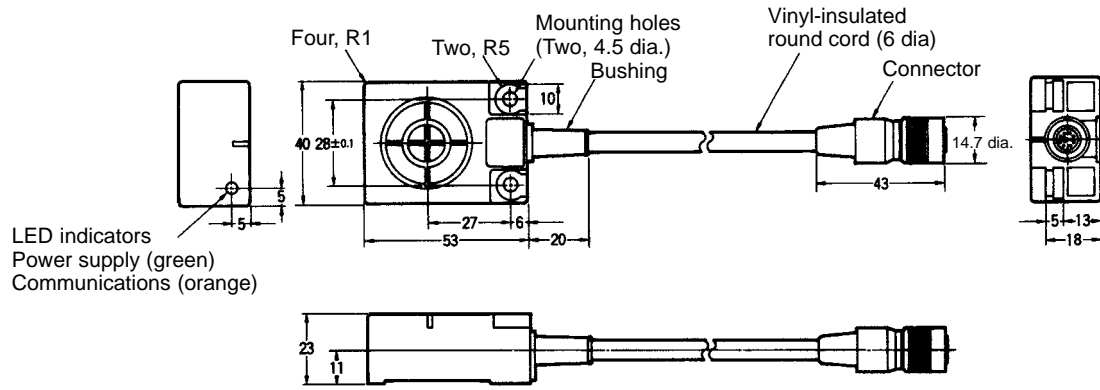

Case material	ABS resin
Fill resin	Epoxy resin
Cable	PVC (oil-resistant)

## 2-2 Data Carriers

### 2-2-1 Specifications and Outer Dimensions

#### V600-D8KR12/13/04

Item	Model		
	V600-D8KR12	V600-D8KR13	V600-D8KR04
Memory capacity	8K bytes		
Memory type	SRAM (static random access memory)		
Battery service life	Refer to the graphs in 2-3 <i>Data Carrier Battery Service Life</i> .		
Number of data read/write conversions	No limit (up to the extent of the battery service life)		
Error detection	16-bit CRC error detection is used in both directions of transmission.		
Operating temperature	Data retention: -40°C to 70°C; read/write: -25°C to 70°C		
Storage temperature	-40°C to 70°C		
Operating humidity	35% to 95% RH		
Degree of protection	Meets or exceeds IEC60529 IP67 standards and JEM IP67G standards.		
Vibration resistance	10 to 500 Hz, 1.0 mm in each direction; acceleration: 150 m/s <sup>2</sup> (about 15 G); one sweep in each of three axis directions, three sweeps in 11 minutes		
Shock resistance	1,000 m/s <sup>2</sup> (about 100 G) three times each in X, Y, Z directions, total 18 times		
Weight (approximate)	70 g	70 g	160 g

V600-D8KR12

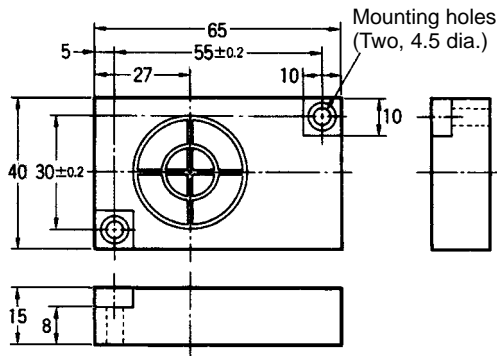

V600-D8KR13

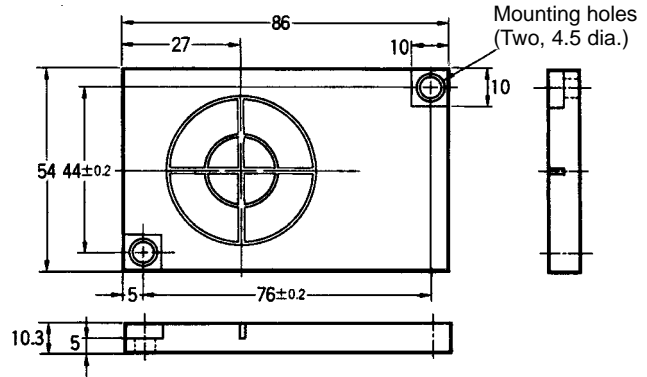

V600-D8KR04

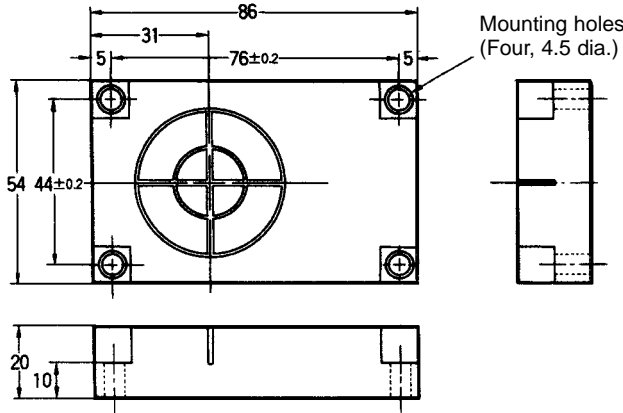

Case material	ABS resin
Fill resin	Epoxy resin

**⚠ WARNING** The SRAM-type Data Carrier has a built-in lithium battery which can combust or explode if mishandled. Do not disassemble the Data Carrier, or subject it to high pressure or high temperatures (of 100°C or more), or dispose of it by incineration.

### V600-D2KR16

Item	V600-D2KR16
Memory capacity	2K bytes
Memory type	SRAM (static random access memory)
Battery service life (See note 1.)	2 years (replaceable battery)
Number of data read/write conversions	No limit (unrelated to battery service life)
Error detection	16-bit CRC error detection is used in both directions of transmission.
Operating temperature	Data retention: -15°C to 70°C; read/write: 0°C to 50°C
Storage temperature	-15°C to 70°C
Operating humidity	35% to 85% RH
Degree of protection (See note 2.)	IEC60529 IP50 standards
Vibration resistance	10 to 150 Hz, 1.5 mm in each direction; acceleration: 100 m/s <sup>2</sup> (about 10 G); for 30 min. each in X, Y, Z directions.
Shock resistance	300 m/s <sup>2</sup> (about 30 G) three times each in X, Y, Z directions, total 18 times
Weight (approximate)	15 g

- Note**
1. This is the battery service life when the battery is used in an environment with an ambient temperature below 25°C. For the relationship between temperature and battery service life, refer to 2-3 *Data Carrier Battery Service Life*.
  2. When the accessory battery replacement cover seal is in place.

#### V600-D2KR16

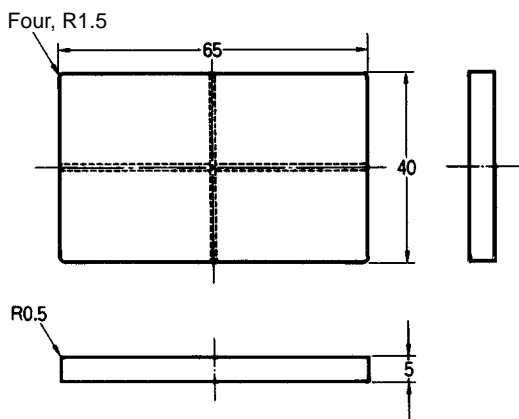

#### Special-purpose Holder (V600-A81)

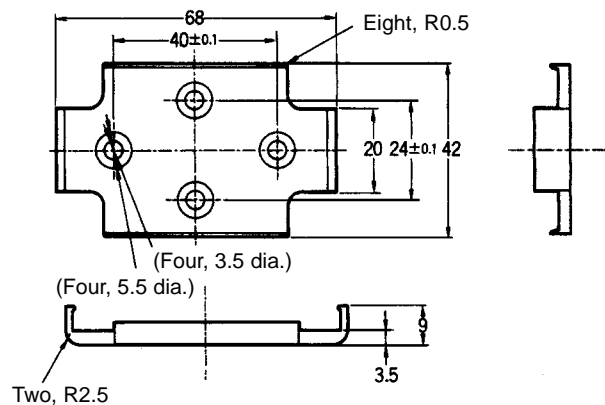

Case material: ABS resin

**⚠ WARNING** The SRAM-type Data Carrier has a built-in lithium battery which can combust or explode if mishandled. Do not disassemble the Data Carrier, or subject it to high pressure or high temperatures (of 100°C or more), or dispose of it by incineration.

## 2-2-2 Memory Map

The Data Carrier (DC) has a memory area of up to 8K bytes. Each address of the memory area specifies one byte. A single byte of data can be written to one address.

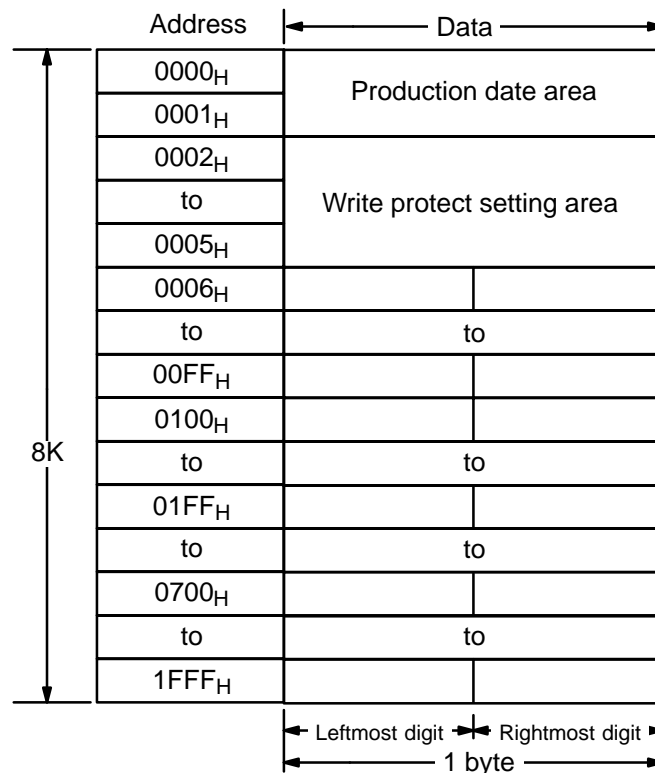

### Production Date Area (Written by Maker)

Address	Bit							
	7	6	5	4	3	2	1	0
0000 <sub>H</sub>	Month (10s digit)				Month (1s digit)			
0001 <sub>H</sub>	Year (10s digit)				Year (1s digit)			

- Note**
1. Address 0000 contains the month of production (March→“03,” October→“10”).
  2. Address 0001 contains the lower two digits of the year (1997→“97”).
  3. This area is read only.

The memory is SRAM, so there is no limit on the number of times that data can be read or overwritten.

The memory capacity is 8 KB, and the available addresses are 0000<sub>H</sub> to 1FFF<sub>H</sub>. The memory contents are preserved by a long-life lithium battery.

## 2-2-3 Write Protect Function

The write protect function protects important data stored in the memory of the Data Carrier, such as product number and model, from being overwritten inadvertently. With this function, the data in a specified memory area can be protected. It is recommended that important data be write-protected as follows:

### Setting the Write Protect Function

The write protect function is set in the four bytes of addresses 0002<sub>H</sub> through 0005<sub>H</sub> of the Data Carrier's memory. The status of the leftmost bit of address 0002<sub>H</sub> determines whether or not the write protect function is in effect.

**When Executing the Write Protect Function**

Address	Bit							
	7	6	5	4	3	2	1	0
0002 <sub>H</sub>	YES/NO		Leftmost two digits of beginning address					
0003 <sub>H</sub>	Rightmost two digits of beginning address							
0004 <sub>H</sub>	Leftmost two digits of ending address							
0005 <sub>H</sub>	Rightmost two digits of ending address							

The region specified by the beginning and ending addresses will be protected when the write protect control bit (leftmost bit of address 0002<sub>H</sub>) is ON, as shown in the following table.

Leftmost bit of 0002 <sub>H</sub>	Write Protect Function
ON	Data is write-protected.
OFF	Data is not write-protected.

Area that can be set:

Beginning address: 0006<sub>H</sub> to 1FFF<sub>H</sub>  
 Ending address: 0006<sub>H</sub> to 1FFF<sub>H</sub>

**Examples**

- 1, 2, 3... 1. The following settings would write-protect addresses 0015<sub>H</sub> through 0120<sub>H</sub> (i.e., the beginning address to the ending addresses):

Address	Bit							
	7	6	5	4	3	2	1	0
0002 <sub>H</sub>	1	0	0	0	0	0	0	0
	8				0			
0003 <sub>H</sub>	0	0	0	1	0	1	0	1
	1				5			
0004 <sub>H</sub>	0	0	0	0	0	0	0	1
	0				1			
0005 <sub>H</sub>	0	0	1	0	0	0	0	0
	2				0			

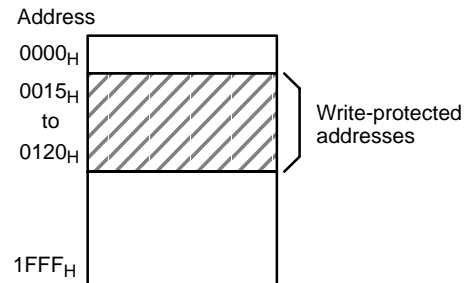

2. To write-protect only 1 byte, set the same address as the start and ending addresses (beginning address = ending address).

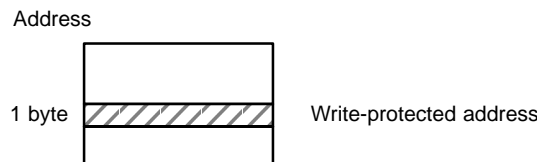

3. If the ending address exceeds the last address of the Data Carrier memory (ending address > 1FFF<sub>H</sub>), the addresses up to 1FFF<sub>H</sub> will be write-protected:

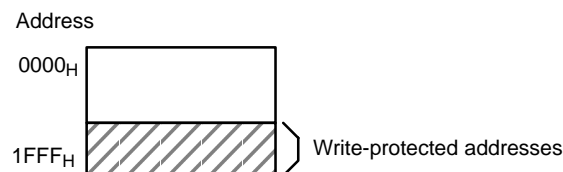

4. If the beginning address is greater than the ending address (beginning address > ending address), the write-protected area will wrap through 0006<sub>H</sub>, so that addresses from 0006<sub>H</sub> through the ending address, and from the beginning address through 1FFF<sub>H</sub> will be write-protected.

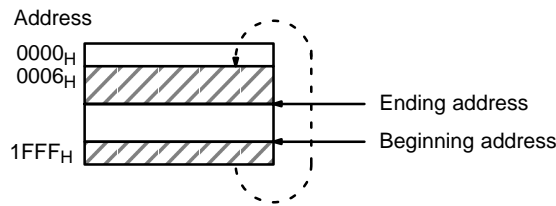

**Canceling Write Protection**

To cancel write protection, turn OFF the leftmost bit of address 0002<sub>H</sub>. The write protection will be cancelled, and the beginning and ending addresses that are set for 0002<sub>H</sub> to 0005<sub>H</sub> will be ignored.

**2-3 Data Carrier Battery Service Life**

**2-3-1 Battery Service Life Factors**

The Data Carrier has a built-in lithium battery that provides power. The service life of the battery depends on the number and size of data transmissions. The graphs below show the relationship between daily number and size of transmissions and battery service life. (The illustrations shown here are representative examples.)

**V600-D8KR12**

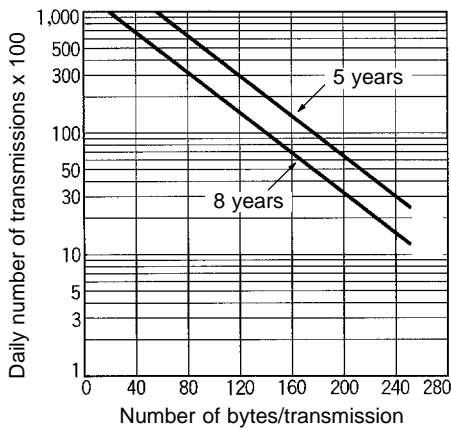

**V600-D8KR13**

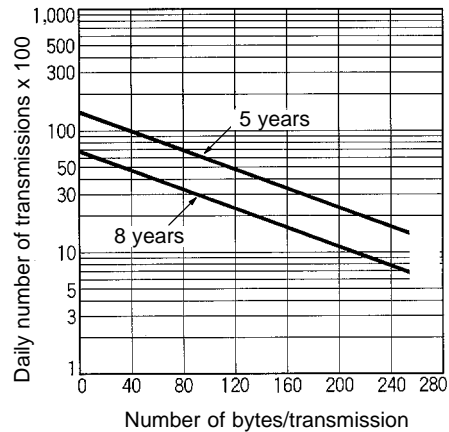

**V600-D8KR04**

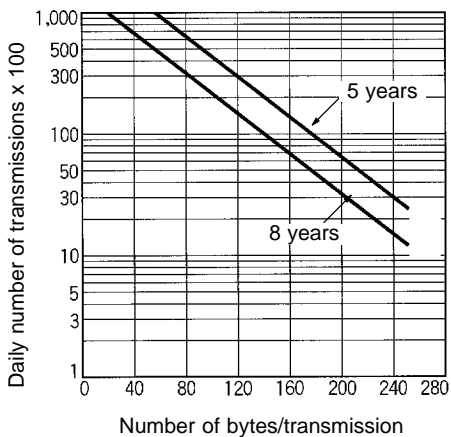

The preceding graphs show the lowest possible lifetimes for DCs in the temperature range -10°C to 55°C (14°F to 131°F). Normally, batteries will last longer at lower ambient temperatures.



With a V600-D8KR04 DC at 55°C (131°F), for example, 200 bytes of data can be accessed 3,000 times a day for 8 years or 6,500 times a day for 5 years.

With a V600-D8KR12 DC at 55°C (131°F), 40 bytes of data can be accessed 2,000 times a day for 8 years or 4,500 times a day for 5 years.

**V600-D2KR16**

The battery used for the V600-D2KR16 has a service life of 2 years at an ambient temperature of 25°C, regardless of the number of access times or R/W bytes.

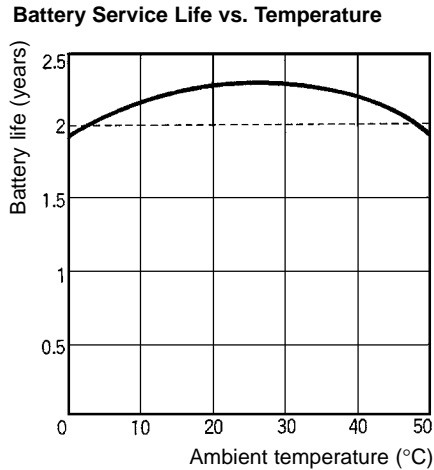

The above graph shows the relationship between the service life of a built-in battery and ambient temperature (after the insulation sheet is removed). The table below shows the life expectancy of a battery that is stored separately (without being installed in the DC).

Temperature	Battery consumption rate (%) per year
20	1
30	2
40	4
50	8
60	16
70	32

If the DC is kept at a temperature of 70°C without removing the insulation sheet, the battery will last for 1.36 years (2 years x (1 – 0.32)). Furthermore, if the DC is kept for one year at a temperature of 70°C without removing the insulation sheet, the battery will last for an additional period of approximately 1.4 years if used at an ambient temperature of 25°C. The life of the battery will be shorter if used at an ambient temperature of 0° or 50°C.

- Note**
1. The data in the V600-D2KR16 will be lost at the time of battery replacement. Be sure to make a backup of the data before replacing the battery.
  2. After replacing the battery, be sure to affix the battery cover seal. IP50 is not guaranteed if the battery cover seal is not affixed.

## 2-3-2 Battery Service Life Expectancy Check

### Checking Whether the Battery is Low

#### Models With Built-in Battery (Except V600-D2KR16)

- 1, 2, 3... 1. Data Carrier battery checks are not performed automatically, only during times of special access.  
 When a battery check is performed, a small current is passed through the DC's internal circuitry. Too much power would be consumed if a battery check was performed automatically every time DC memory was accessed. Incorporate a routine once-a-day check when creating the system program.
2. Access for checking whether the battery is low is only enabled when the two bytes of data from address 0000H to 0001H are read.  
 Use one of the following commands to check the battery status. (The CR at the end of each command means carriage return.)
- Read command: RD H/A 1 0000 02\*CR
  - Auto Read command: AR H/A 1 0000 02\*CR
  - Polling Auto Read command: PR H/A 1 0000 02\*CR
3. If the end code of the response is 00, the battery is operating normally. If the end code is 7B, the battery is low. The following are responses to Read and Auto Read commands sent to a DC with a good battery:

```

RD 00 0997*
AR 00 0997*
-----
    |
    +----- Read data
               Production date: Sept., 1997
    
```

Normal end code

The following are responses to Read and Auto Read commands sent to a DC with a low battery:

```

RD 7B 0997*
AR 7B 0997*
-----
    |
    +----- Read data
               Production date: Sept., 1997
    
```

Low battery end code

**Note** With the V600-D2KR16 (replaceable-battery model), read/write commands are executed without regard to addresses.

### Service Life of Data Carriers After the Battery-low Code is Generated

Under ordinary operating conditions the DC can be used for about one month after a low battery end code is received. However, it is recommended that the DC be replaced with a new one as soon as possible.

The V600-D2KR16 (replaceable-battery model) can be used for approximately two weeks under normal operating conditions, but it is recommended that the battery be replaced with a new one as soon as possible.

**Note** The DC (except for the V600-D2KR16, SRAM memory model) contains a thionyl chloride-type lithium battery. One characteristic of this type of battery is its tendency to develop a higher internal resistance when it is not used. If the battery isn't used for several months, the internal resistance can increase enough to cause a low battery response, even if the battery is good.

Consequently, after several months of disuse it is recommended to transmit data to/from the DC for about 10 minutes to "warm up" the battery and decrease its internal resistance. This operation will have almost no effect on the useful life of the battery.

# **SECTION 3**

## **Communications Specifications**

This section provides specifications for communications.

3-1	Transmission Range .....	16
3-1-1	Transmission Range Specifications (Certified Performance) .....	16
3-1-2	Transmission Areas .....	17
3-2	Transmission Time .....	17
3-3	Data Carrier Speed .....	19

### 3-1 Transmission Range

#### 3-1-1 Transmission Range Specifications (Certified Performance)

R/W Head	Setting conditions		Transmission range (unit: mm, axis slip: ±10 mm)			
			V600-D8KR12	V600-D8KR13	V600-D8KR04	V600-D2KR16
V600-H07	Stationary	Flush-mounted within metal	10 to 50	10 to 30	See page 28.	---
		Surface-mounted on metal	10 to 60	10 to 35	10 to 100	---
	Moving	Flush-mounted within metal	25 to 50	20 to 30	See page 28.	---
		Surface-mounted on metal	25 to 60	20 to 35	50 to 100	---
V600-H11	Stationary	Flush-mounted within metal	5 to 40	10 to 30	See page 28.	2 to 15
		Surface-mounted on metal	5 to 45	10 to 30	10 to 65	2 to 15
	Moving	Flush-mounted within metal	25 to 40	15 to 30	See page 28.	6 to 15
		Surface-mounted on metal	25 to 45	15 to 30	30 to 65	10 to 15

- Note**
1. These specifications are the certified performance when taking into consideration variations in ambient temperatures and products.
  2. The read range and the write range are the same.
  3. The Data Carrier and Read/Write Head installation conditions are as follows:

#### 1) V600-D8KR12, V600-D8KR13 Data Carriers

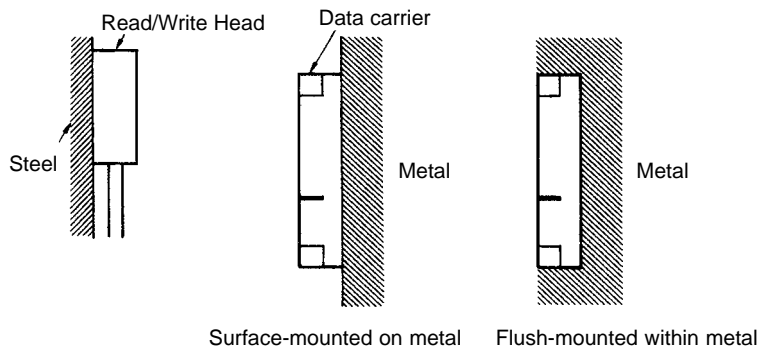

#### 2) V600-D8KR04 Data Carriers

For flush-mounting within metal, the read/write distance changes depending on distance  $x$  from the metal.

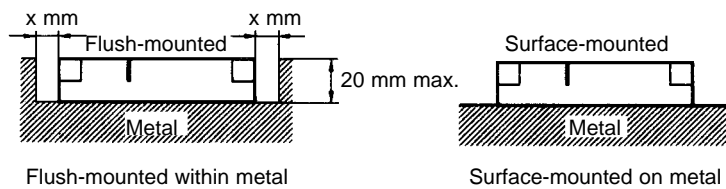

#### 3) V600-D2KR16 Data Carriers

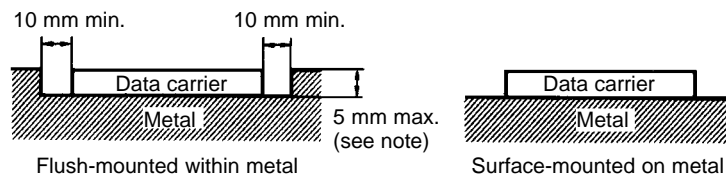

For details regarding R/W Head and DC installation, refer to *Section 4 Installation*.

### 3-1-2 Transmission Areas

The following diagrams show representative examples of the communications areas. All measurement units are shown in mm.

V600-D8KR12 and V600-H07

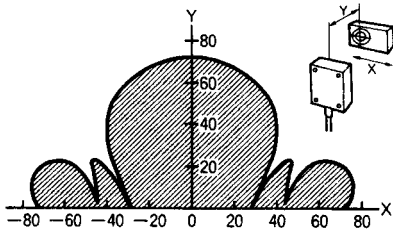

V600-D8KR12 and V600-H11

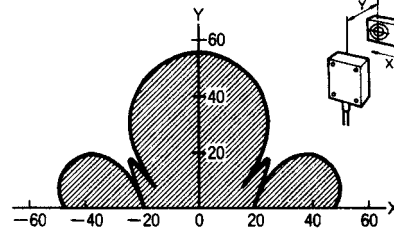

V600-D8KR13 and V600-H07

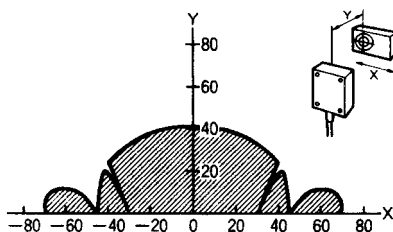

V600-D8KR13 and V600-H11

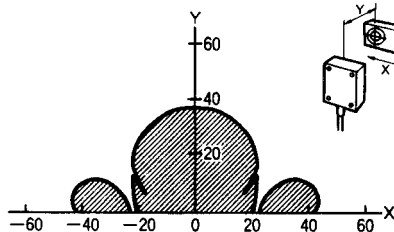

V600-D8KR04 and V600-H07

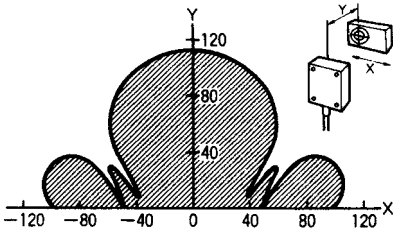

V600-D8KR04 and V600-H11

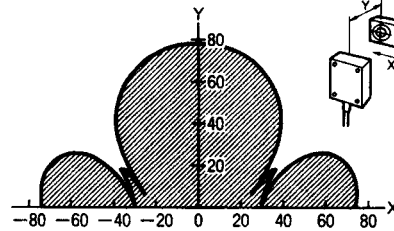

V600-D2KR16 and V600-H11

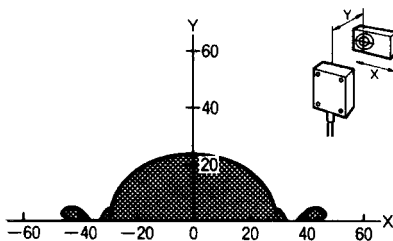

**Note** The mounting method is surface-mounted on metal in all cases.

## 3-2 Transmission Time

### Transmission Time

Transmission times are the same for all models of R/W Heads and DCs covered in this manual, although transmission times are different for DCs that contain batteries. The term “transmission time” is used to indicate both the turn-around time (TAT) and the lower level transmission time between the R/W Head and DC.

The TAT is the total time required from the transmission of a command from a host device (such as a host computer) until the reception of a response at the host device.

The lower-level transmission time is the time required for transmission of data between the R/W Head and DC.

The following diagram shows the TAT and lower-level transmission time for the READ command.

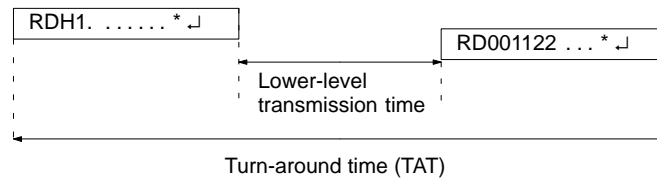

**TAT (Reference)**

The following diagrams show the TAT and lower-level transmission time for V600-CA1A, V600-CA2A, V600-CD1D-V2, and V600-CF1A Serial Interface ID Controllers. (The TAT for Parallel Interface ID Controllers and ID Sensor Units varies with the host's software.)

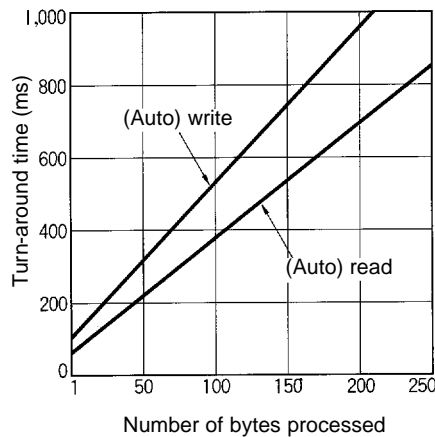

Calculation Method (Reference)

(Unit: ms)

Read/Write	TAT
Read	$T = 2.9N + 69.8$
Write	$T = 5.3N + 105.6$

N: Number of bytes processed

- Note**
1. The value given for the TAT data assumes that the communications settings for the V600-CA1A ID Controller are as follows:  
Baud rate: 9600 bps; data length: 8 bits; stop bits: 1; parity: odd.
  2. The number of bytes is the number for ASCII code. (For details, refer to the *RFID System Operation Manual (Z83)*.)

**Transmission Time With the Data Carrier (Reference)**

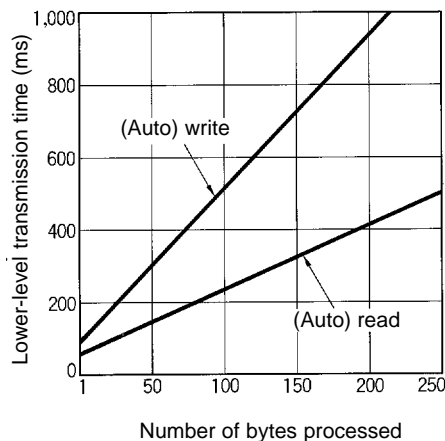

Calculation Method (Reference)

(Unit: ms)

Read/Write	Lower-level transmission time
Read	$T = 1.8N + 48.4$
Write	$T = 4.2N + 86.5$

N: Number of bytes processed

### 3-3 Data Carrier Speed

The number of bytes that can be processed using the Auto Read and Auto Write commands depends on the speed of the DC. The relationship between the number of bytes and DC speed in m/minute can be determined from the following equation.

$$\text{Max. DC Speed} = \frac{\text{Distance travelled in the transmission range (m)}}{\text{Lower-level transmission time (min)}}$$

- The “distance travelled in the transmission range (m)” is the maximum width of the transmission range (in the X direction). Refer to the diagrams in 3-1 *Transmission Range*.
- The “lower-level transmission time (min)” is the time required for transmission between the DC and the R/W Head. For details regarding this calculation, refer to 3-2 *Transmission Time*.

#### Calculation Example

In this example diagram, the V600-D8KR04 and V600-H07 are combined and four bytes are read.

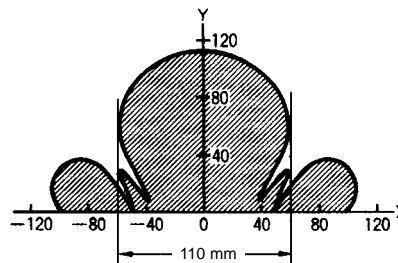

This diagram shows the following:

Distance travelled in transmission range, Y (transmission distance) = 110 mm

Lower-level transmission time,  $T = 1.8 \times 4 + 48.4 = 55.6$  ms.

Accordingly, the DC speed in this case will be as follows:

$$\begin{aligned} \text{Max. DC Speed} &= \frac{\text{Distance travelled in the transmission range (m)}}{\text{Lower-level transmission time (min)}} = \frac{110 \text{ (mm)}}{55.6 \text{ (ms)}} \\ &= 118.7 \text{ m/min} \end{aligned}$$

- Note**
1. The distance travelled in the transmission time will vary depending on the read/write distance and the shaft slippage. Refer to the diagrams in 3-1 *Transmission Range*.
  2. The DC speed is the standard value. Before using the equipment, run a test to determine the speed under the actual operating conditions.
  3. The DC speed data above do not take into account possible transmission errors in host or lower-level communications.
  4. When the V600-CA8A/CA9A is used, the speed will vary depending on the software at the host device.

# SECTION 4

## Installation

This section describes the recommended installation methods for the R/W Heads and Data Carriers (DCs), and provides details on the battery's service life expectancy and methods to check the battery's condition.

4-1	R/W Head Installation .....	22
4-1-1	Installation Method .....	22
4-1-2	Effect of Surrounding Metals .....	23
4-1-3	Interference between R/W Heads .....	24
4-1-4	Interference with Proximity Sensors .....	25
4-2	Data Carrier Installation .....	26



## 4-1 R/W Head Installation

### 4-1-1 Installation Method

#### V600-H07 R/W Head

Use M4 screws and spring washers (in four places) for R/W Head installation. Tighten the screws to a torque of 0.7 to 1.2 N•m (approximately 7 to 12 kgf•cm).

There are no restrictions on the mounting direction or the direction of access to the DC, but if the R/W Head is to be installed near a device such as a conveyance belt, make sure there is no danger of the R/W Head being accidentally struck.

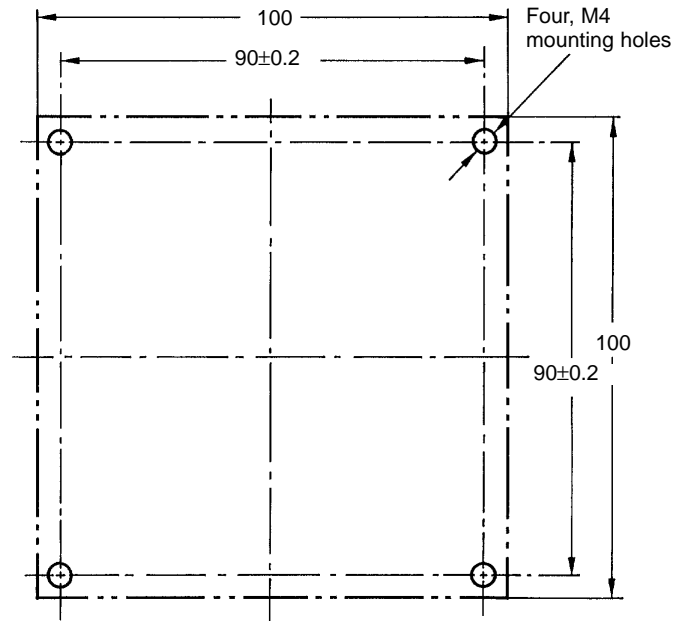

#### Mounting Bracket Dimensions (V600-H07 Only)

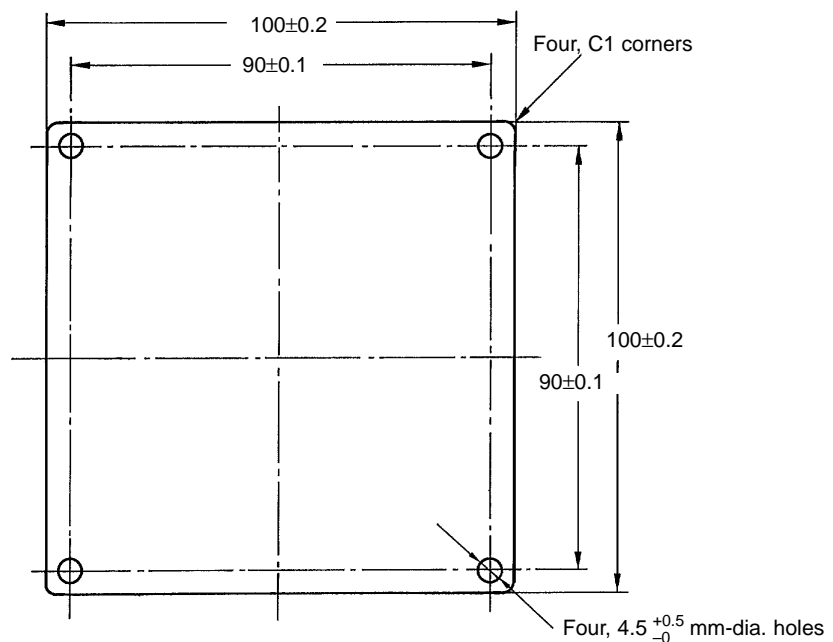

**Note** A mounting bracket is provided with the V600-H07. It is not necessary to use this bracket if a metal mounting plate larger than the 100×100 mm “footprint” of the R/W Head is used for installation.

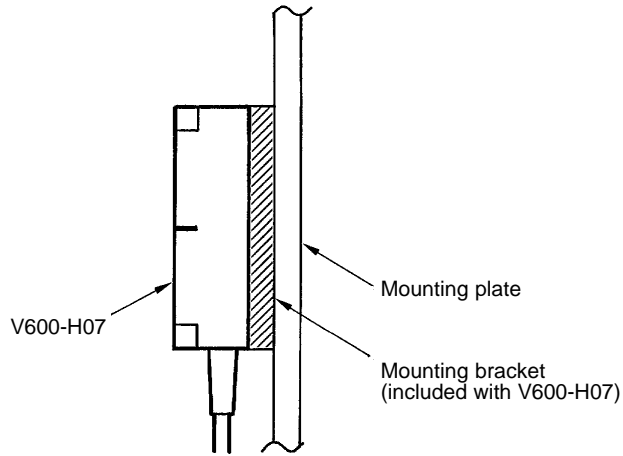

**Caution** Be sure to ground the mounting surface of the R/W Head if it is metal.

**V600-H11 R/W Head**

**(1) Front Panel Mounting**

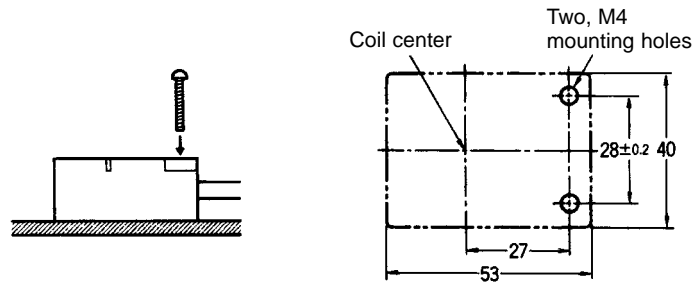

**2) Rear Panel Mounting**

Insert the nuts that are included with the R/W Head into the locations marked “A.”

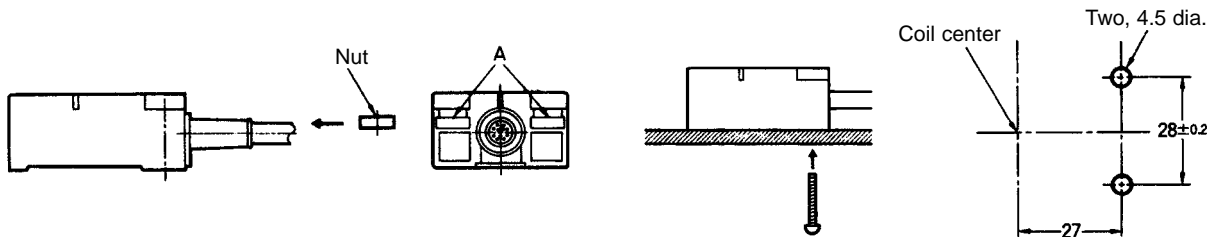

**4-1-2 Effect of Surrounding Metals**

**V600-H07 R/W Head**

In addition to surface mounting, it is also possible to flush-mount the V600-H07 within a metal casing to protect it from being struck by other objects. To prevent malfunctioning, allow at least 50 mm between the sides of the R/W Head and the metal casing, and do not mount the R/W Head below the metal surface. If the

gap between sides of the R/W Head and the metal casing is less than 50 mm, the read/write transmission range will be greatly diminished.

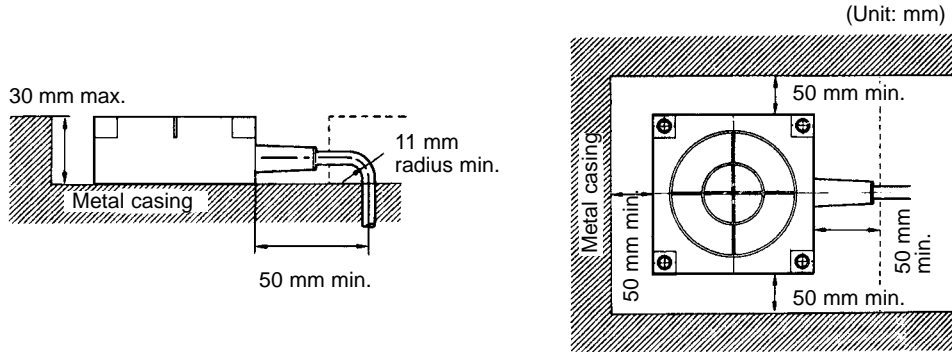

- Note**
1. Do not bend the R/W Head's cable into a curve tighter than 11 mm in radius.
  2. The read/write transmission range will be reduced significantly if the R/W Head is installed closer than 50 mm to metal surfaces.

**V600-H11 R/W Head**

In addition to surface mounting, it is also possible to flush-mount the V600-H11 within a metal casing to protect it from being struck by other objects. To prevent malfunctioning, allow at least 30 mm between the sides of the R/W Head and the metal casing, and do not mount the R/W Head below the metal surface. If the gap between sides of the R/W Head and the metal casing is less than 30 mm, the read/write transmission range will be greatly diminished.

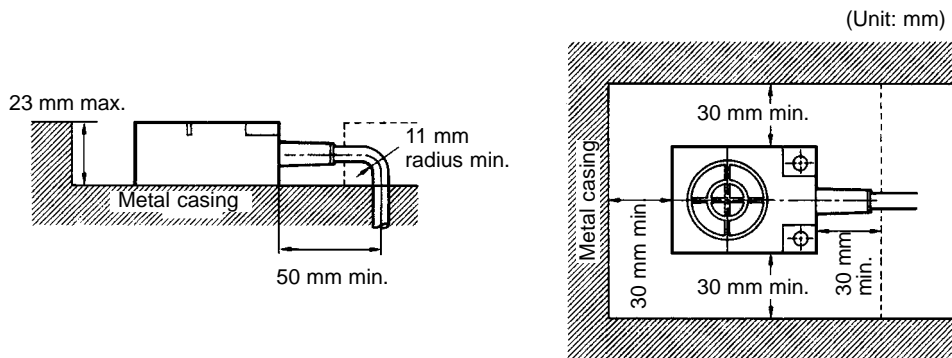

- Note**
1. Do not bend the R/W Head's cable in a curve tighter than 11 mm in radius.
  2. The read/write transmission range will be reduced significantly if the R/W Head is installed closer than 30 mm to metal surfaces.

**4-1-3 Interference between R/W Heads**

When using two or more R/W Heads, be sure to allow enough space between the R/W Heads to avoid errors caused by mutual interference. The diagrams below show the minimum spacing required.

**V600-H07 R/W Head**

When facing each other, V600-H07 R/W Heads should be installed at least 650 mm apart if RD/WT commands are used, and 900 mm apart if auto commands are used.

When facing the same direction, V600-H07 R/W Heads should be installed at least 550 mm apart (center to center) if RD/WT commands are used, and 1,200 mm apart (center to center) if auto commands are used.

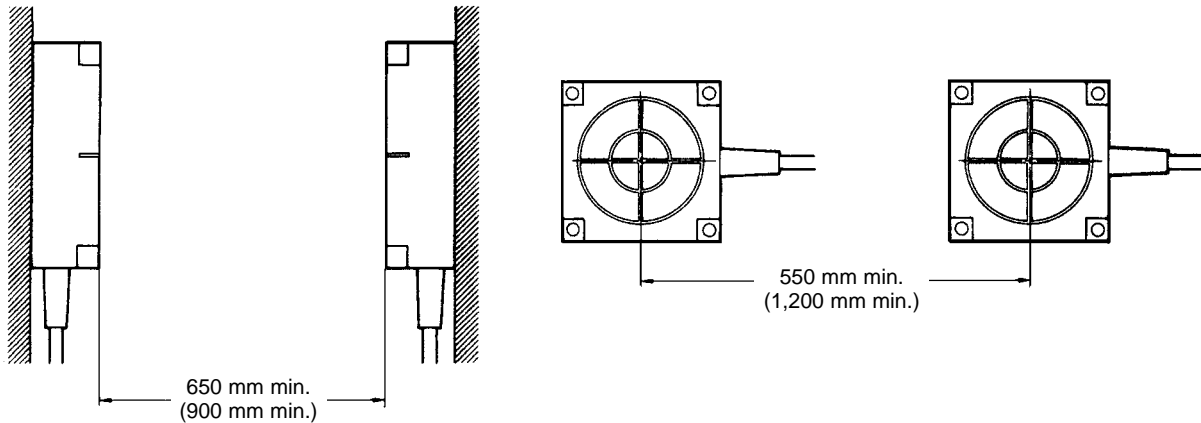

#### V600-H11 R/W Head

When facing each other, V600-H07 R/W Heads should be installed at least 200 mm apart regardless of whether RD/WT commands or auto commands are used.

When facing the same direction, V600-H07 R/W Heads should be installed at least 200 mm apart regardless of whether RD/WT commands or auto commands are used.

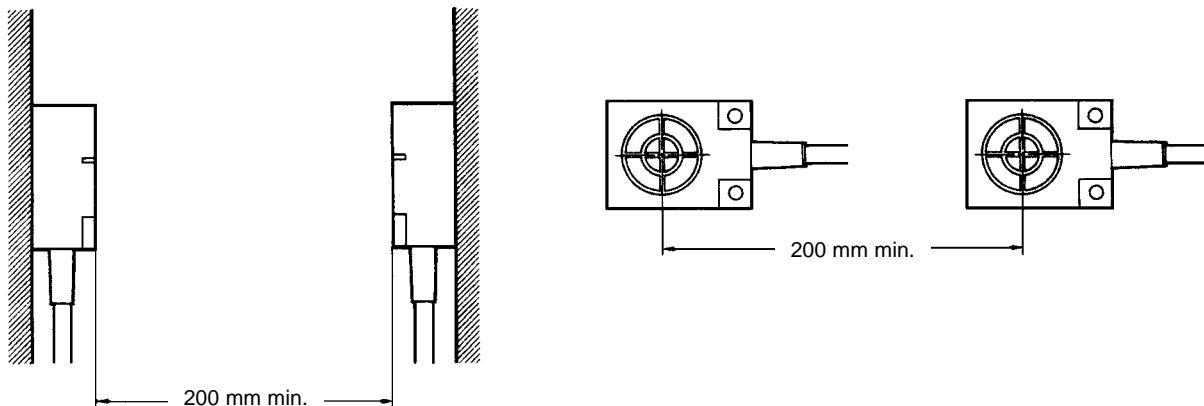

**Note** For applications in which no two R/W Heads transmit or receive data at the same time (i.e., in which the R/W Heads read and write independently), there is no risk of mutual interference and the R/W Heads can be installed in proximity. Transmission and reception in this case refer to the R/W Heads oscillating after receiving commands.

#### 4-1-4 Interference with Proximity Sensors

V600-series R/W Heads use electromagnetic linking (frequency: 530 kHz), so, if they are installed near sensors (such as proximity sensors) with an oscillation frequency of 400 to 600 kHz, it may cause the sensors to malfunction. Before installing R/W Heads, and when selecting sensors, be sure to conduct tests to make sure that there will be no interference.

#### V600-H07 R/W Head

As shown in the following diagrams, a V600-H07 R/W Head should be at least 400 mm from a proximity sensor when the two are facing the same direction or

perpendicular. When the two are facing each other, they should be at least 300 mm apart.

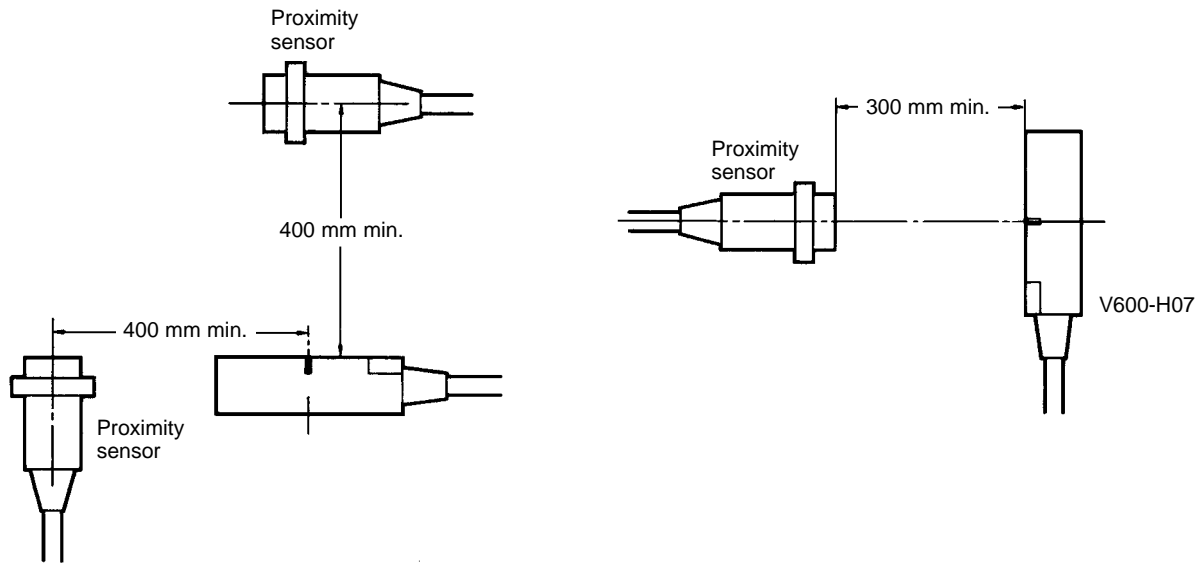

**V600-H11 R/W Head**

As shown in the following diagrams, a V600-H11 R/W Head should be at least 100 mm from a proximity sensor regardless of whether the two are parallel, perpendicular, or facing each other.

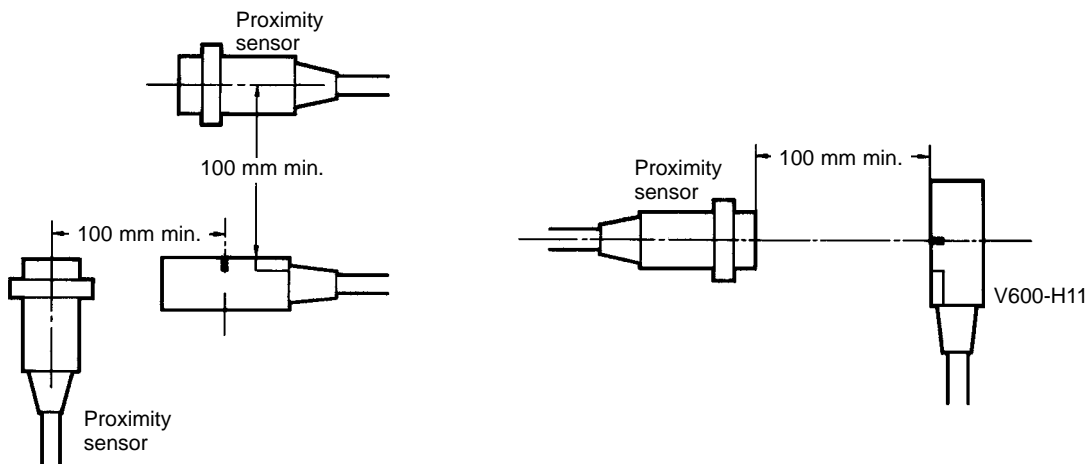

## 4-2 Data Carrier Installation

### V600-D8KR12/KR13/KR04 Data Carriers

**Installation Method**

Use M4 screws and spring washers for DC installation. Tighten the screws to a torque of 0.7 to 1.2 N•m (approximately 7 to 12 kgf•cm).

There are no restrictions on the mounting direction or the direction with respect to the R/W Heads.

V600-D8KR12

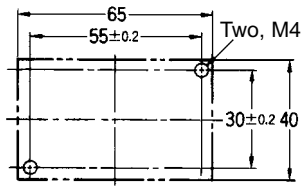

V600-D8KR13

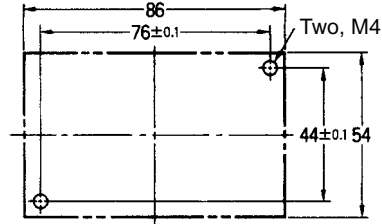

V600-D8KR04

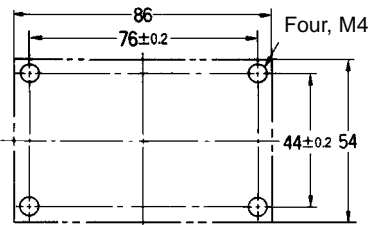

Mounting in Metal Casing

V600-D8KR12

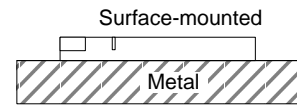
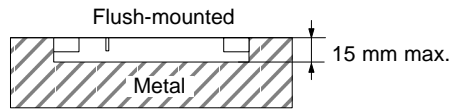

V600-D8KR13

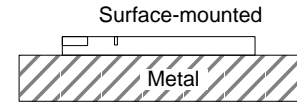
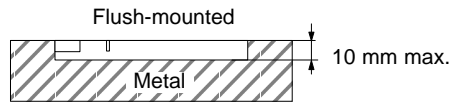

The V600-D8KR12 and V600-D8KR13 DCs can be either surface-mounted or flush-mounted. When flush-mounted in metal, the top of the DC must not be lower than the surface of the metal casing.

V600-D8KR04

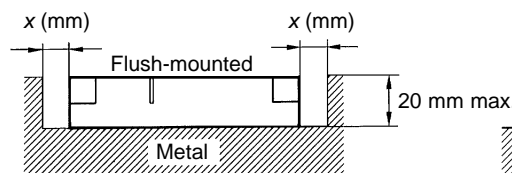

Flush-mounted in metal casing

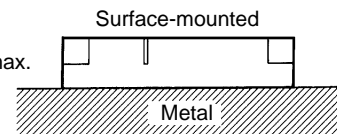

Surface-mounted on metal

When the V600-D8KR04 is flush-mounted in a metal casing, the transmission range varies according to the width of the gap ( $x$ ) between the metal and the DC, as shown in the following graphs.

When Combined With V600-H07

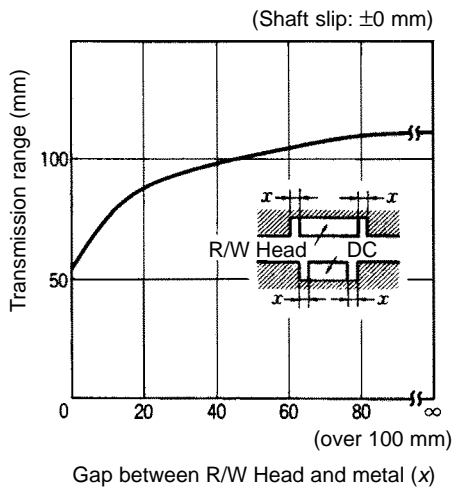

When Combined With V600-H11

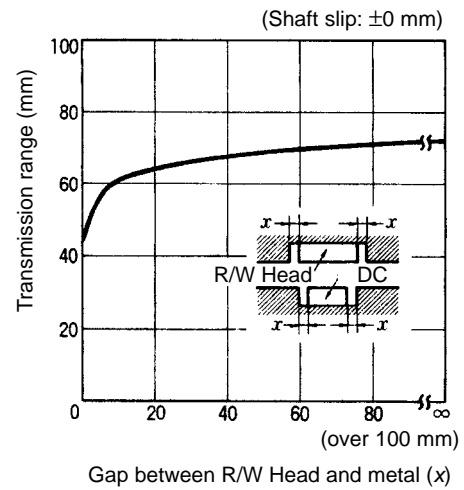

**Effect of Misalignment**

The transmission range will be reduced if the R/W Head does not face the DC directly when data is transmitted. Try to keep any misalignment below  $10^\circ$ , as shown in the following diagram.

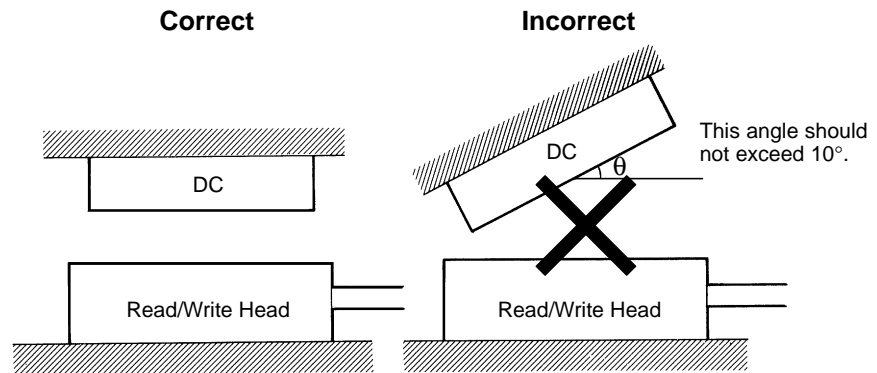

**V600-D2KR16 Data Carriers**

**Installation Method**

Use a special-purpose holder (purchased separately) for installation. First secure the holder with flat countersunk-head screws in at least two places, and tighten the screws to a torque of 0.3 to 0.5 N•m (approximately 3 to 5 kgf•cm). Then insert the DC into this holder by hand.

Be sure to attach the battery cover seal to the back of the DC. If this seal is not affixed, the IP protective structure standards will not be satisfied.

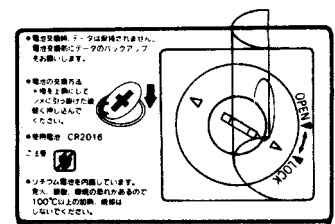
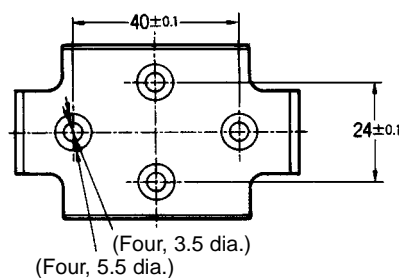

**Mounting in a Metal Casing**

The V600-D2KR16 can be either surface-mounted or flush-mounted in a metal casing. If mounted as shown in the following diagrams, there will be no effect on the transmission range.

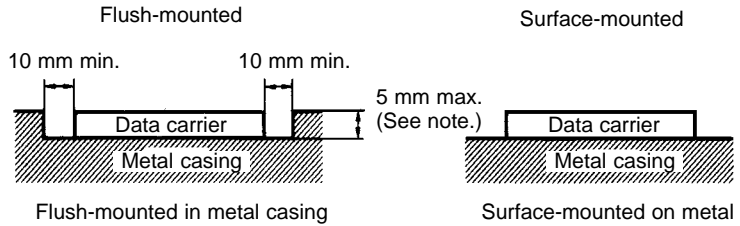

**Note** When the special-purpose holder is used, this becomes 9 mm max.

**Effect of Misalignment**

The transmission range will be reduced if the R/W Head does not face the DC directly when data is transmitted. Try to keep any misalignment below 10°, as shown in the following diagram.

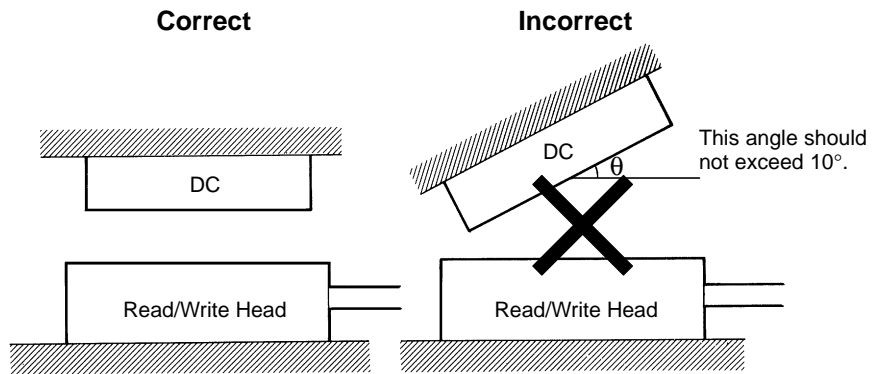



## **SECTION 5**

### **Chemical Resistance**

This section shows the chemicals that affect R/W Heads and Data Carriers.

R/W Heads and Data Carriers are constructed using both ABS resin and epoxy resin. Referring to the following charts, be sure to use only those chemicals that have no effect on the ABS or epoxy resins and avoid using those chemicals that do have an effect.

Applications requiring explosion-proof capability are not possible.

**Chemicals that Cause Warping, Cracking, Etc.**

Affecting ABS	Affecting Epoxy
Trichlene, acetone, xylene, toluene, gasoline, creosol, methylene chloride, phenol, cyclohexane, aqua, regia, chromic acid, sulfuric acid (90% RT), methyl ethyl ketone, aniline, nitrobenzene, monochlorobenzene, pyridine, nitric acid (60% RT), formic acid (80% RT)	Aqua regia, chromic acid, sulfuric acid (90% RT), nitric acid (60% RT), ammonia solution, acetone, methylene chloride, phenol, trichlene

**Chemicals that May Cause Discoloring, Swelling, Etc.**







Affecting ABS	Affecting Epoxy
Hydrochloric acid, alcohol, Freon, sodium hydroxide, hydrogen peroxide, benzene, sulfuric acid (10% RT), nitric acid (10% RT), phosphoric acid (85% RT), ammonia solution	Sulfuric acid (10% RT), nitric acid (10% RT), hydrochloric acid (30% RT), acetic acid (50% RT), calcium hydroxide, benzene, creosol, alcohol, cyclohexane, toluene, xylene, benzene, grease

**Chemicals that Have No Effect**

ABS	Epoxy
Ammonia, kerosene, mineral oil, developer, Yushiroken S50, Chemi-Cool Z, Velocity No. 3, Yushiroken EEE-30Y, petroleum, grease acetate, calcium hydroxide, phosphoric acid (30% RT), hydrochloric acid (10% RT), potassium hydroxide	Ammonia, hydrochloric acid (10% RT), potassium hydroxide, petroleum, gasoline, Yushiroken S50, Chemi-Cool Z, Velocity No. 3, Yushiroken EEE-30Y

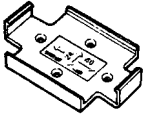
 **Caution** The test results listed were obtained at room temperature (approximately 23°C). Some of the chemicals listed as having no effect may cause problems at higher or lower temperatures.

## Appendix A Accessories (Sold Separately)

Item	Specification	Model	Remarks
Extension cable for R/W Heads 	3 m	V600-A45	The connectors are not waterproof.
	5 m	V600-A44	
	10 m	V600-A40	
	20 m	V600-A41	
	30 m	V600-A42	
Extension cable for R/W Heads 	3 m	V600-A56	The connectors are not waterproof.
	5 m	V600-A55	
	10 m	V600-A50	
	20 m	V600-A51	
	30 m	V600-A52	
Special-purpose holder 	For V600-D2KR16 only 	V600-A81	Secured with M3 flat countersunk-head screws (in at least two places).
Lithium battery (CR2016) 	For V600-D2KR16 only 	V600-A82	CR2016 commercially available, with battery cover tool.

# Appendix B

## Discontinued Models and Replacements

### Discontinued Models

V600-H6  
V600-D2KR01, V600-D8KR01  
V600-D2KR02, V600-D8KR02  
V600-D2KR03, V600-D8KR03

### Replacement Models

V600-H12, V600-H11  
V600-D8KR11  
V600-D8KR12  
V600-D8KR13

OMRON appreciates your continued patronage. In October, 1994, it was announced that production of the 500-kHz-frequency wireless transmission models in the V600-series RFID System would be discontinued in March of 1996. The following information is an update on the models that will be discontinued and the models that will replace them.

### Background

- In 1988, OMRON began development and production of the V600-series RFID System in response to customer requests, and provided a line of products in this series.
- Systems such as the V600-series RFID System which use electromagnetic linking are required to be in compliance with laws regulating radio wave transmissions. Within Japan there is no particular problem for ID makers as long as they can demonstrate that they satisfy the prescribed values in the radio wave regulations. And products used in the United States, for example, must receive certification from the Federal Communications Commission (FCC). Accordingly, OMRON received FCC certification for the V600 Series in 1989.
- Subsequently, however, the FCC rules were revised, and models using a frequency of 500 kHz for wireless transmission between read/write heads and data carriers could not be newly sold or delivered (including installation) in the United States as of June 23, 1994.

### OMRON's Response

- In response to the above problem, OMRON changed the frequency for all new wireless-transmission products in the V600 Series from 500 kHz to 530 kHz, and in 1991 received formal certification from the FCC. Since then, all subsequent models in this series have also been developed for 530-kHz specifications.
- Taking into consideration the maintenance and support of existing 500-kHz models from June 23, 1994, onwards, the models that OMRON introduced in April, 1994, are completely interchangeable with the earlier models in all respects (such as shape, installation, etc.) except for transmission frequency.

### Advantages for Customers

Standardizing all of the V600-series models to 530 kHz offers the following advantages to customers.

- There is no longer any need to distinguish between models exported to the United States, and other countries, and models marketed in Japan. This simplifies the processes of model selection and system design, and reduces the chances of accidentally ordering the wrong models.
- This change makes it easier to combine various read/write heads and data carriers, thereby expanding the options available when selecting models for system design. For example, it is now possible to use a single data carrier in combination with the optimum read/write head for each process in an assembly line.
- For OMRON as well, this change makes it easier to improve production schedules and quality control by integrating product lines.

## **Materials Provided Here**

The following materials are provided in this appendix:

- Information regarding model changes
- Differences in specifications/performance between 500-kHz and 530-kHz models:
  - 530-kHz model specifications/performance
  - 500-kHz model specifications/performance
- Combining 500-kHz and 530-kHz models:

To some extent there are disadvantages such as a reduction in transmission range from combining 500-kHz and 530-kHz models. Considering the circumstances described above, please upgrade to the replacement models whenever convenient.

# Model Changes

## Discontinued Models

All 500-kHz models have been discontinued.

R/W head: V600-H06

Data carriers: V600-D2KR01, V600-D8KR01, V600-D2KR02, V600-D8KR02, V600-D2KR03, V600-D8KR03

From now on, please use 530-kHz models.

## Replacement Models

The following table shows the models that are replacing each of the discontinued models.

Discontinued model (500 kHz)	Replacement model (530 kHz)
V600-H06	V600-H11 or V600-H12 (See note 1.)
V600-D□KR01	V600-D8KR11 or V600-D8KR04 (See note 2.)
V600-D8KR02	V600-D8KR12
V600-D8KR03	V600-D8KR13

- Note**
- The V600-H12 has the same specifications as the V600-H06 except for the transmission range. The V600-H11 is a compact, low-cost model.
  - The V600-D8KR11 can be flush-mounted in a metal casing. If the V600-DKR04 flush-mounted, the restriction illustrated below applies. (In the V600-DKR04 diagram, the transmission range changes according to distance  $x$ .)

### V600-D8KR11

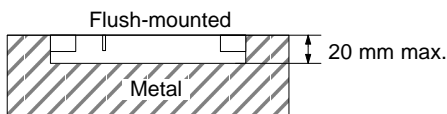

### V600-DKR04

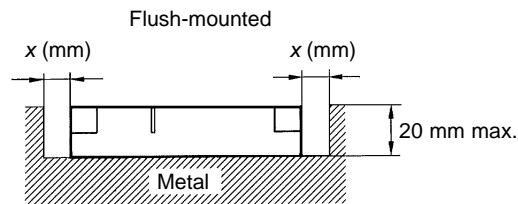

The following diagrams show the effect of the surrounding metal on the transmission range.

### V600-H11/V600-D8KR04

(Shaft slip:  $\pm 0$  mm)

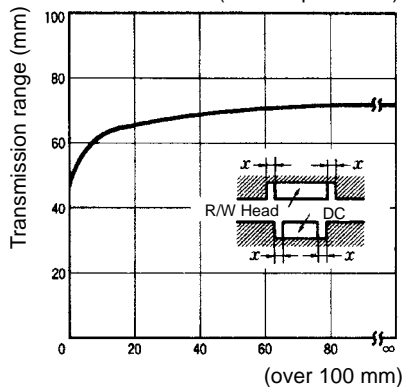

Gap between R/W Head and metal ( $x$ )

### V600-H12/V600-D8KR04

(Shaft slip:  $\pm 0$  mm)

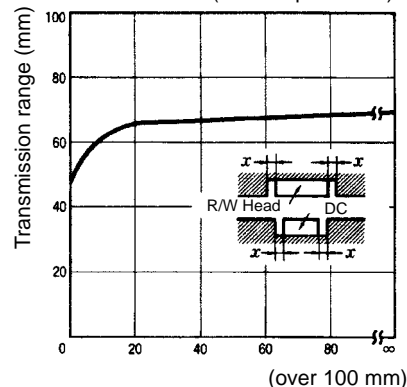





Gap between R/W Head and metal ( $x$ )

## Specifications and Performance of 530-kHz Models

### Data Carriers

V600-D8KR11  
 V600-D8KR12  
 V600-D8KR13  
 V600-D8KR04

Item	Model			
	(Standard type) V600-D8KR11 	(Compact type) V600-D8KR12 	(Thin type) V600-D8KR13 	(Mid-range type) V600-D8K04 
Memory capacity	8K bytes			
Memory type	SRAM (static random access memory)			
Transmission range	(Refer to transmission range specifications on following page.)			
Battery service life (See note.)	8 years	5 years	8 years	
Number of data read/write conversions	No limit (up to the extent of the battery service life).			
Error detection	16-bit CRC error detection is used in both directions of transmission.			
Operating temperature	-25°C to 70°C			
Storage temperature	-40°C to 70°C			
Operating humidity	35% to 95% RH			
Storage humidity	35% to 95% RH			
Degree of protection	Meets or exceeds IEC60529 IP67 and JEM IP67G standards for submersion and oil-resistance.			
Vibration resistance	10 to 500 Hz, 1.0 mm in each direction; acceleration: 150 m/s <sup>2</sup> (about 15 G); one sweep in each of three axis directions, three sweeps in 11 minutes			
Shock	1,000 m/s <sup>2</sup> (about 100 G) three times each in X, Y, Z directions			
Dimensions	86 x 54 x 20 (mm)	65 x 40 x 15 (mm)	86 x 54 x 10.3 (mm)	86 x 54 x 20 (mm)
Weight	Approx. 170 g	Approx. 70 g		Approx. 160 g

R/W Heads

V600-H11  
V600-H12

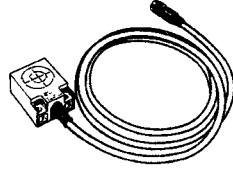
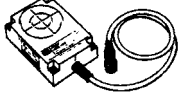
Item	Model	
	V600-H11	V600-H12
		
Operating frequency	530 kHz	
Operating temperature	-10°C to 60°C	-25°C to 70°C
Storage temperature	-25°C to 70°C	-40°C to 85°C
Operating humidity	35% to 95% RH	
Storage humidity	35% to 95% RH	
Degree of protection	Meets or exceeds IEC60529 IP67 and JEM IP67G standards for submersion and oil-resistance.	
Vibration resistance	10 to 500 Hz, 1.0 mm in each direction; acceleration: 150 m/s <sup>2</sup> (about 15 G); X, Y, Z directions, 30 minutes	
Shock resistance	500 m/s <sup>2</sup> (about 50 G) three times in each direction	
Dimensions	53 x 40 x 23 (mm)	100 x 70 x 30 (mm)
Weight	Approx. 650 g (with 10-m cable)	Approx. 1 kg (with 10-m cable)



# Transmission Range Specifications (Recommended Operating Area)

## When Combined With V600-H11

Item			Model			
			V600-D8KR11	V600-D8KR12	V600-D8KR13	V600-D8KR04
Range	Stationary	Flush-mounted within metal	10 to 50 mm	5 to 40 mm	10 to 30 mm	Refer to Graph A and the transmission area diagrams.
	Moving	Surface-mounted on metal	10 to 55 mm	5 to 45 mm	10 to 30 mm	
	Stationary	Flush-mounted within metal	30 to 50 mm	25 to 40 mm	15 to 30 mm	
	Moving	Surface-mounted on metal	30 to 55 mm	25 to 45 mm	15 to 30 mm	

(Shaft slip: ±10 mm)



The transmission range in the specifications is satisfied even if the back panel is not metal.

## When Combined With V600-H12

Item			Model			
			V600-D8KR11	V600-D8KR12	V600-D8KR13	V600-D8KR04
Range	Stationary	Flush-mounted within metal	10 to 40 mm	5 to 25 mm	10 to 35 mm	Refer to Graph B and the transmission area diagrams.
	Moving	Surface-mounted on metal	15 to 45 mm	10 to 30 mm	15 to 40 mm	
	Stationary	Flush-mounted within metal	20 to 40 mm	15 to 25 mm	20 to 35 mm	
	Moving	Surface-mounted on metal	25 to 45 mm	20 to 30 mm	25 to 40 mm	

(Shaft slip: ±10 mm)

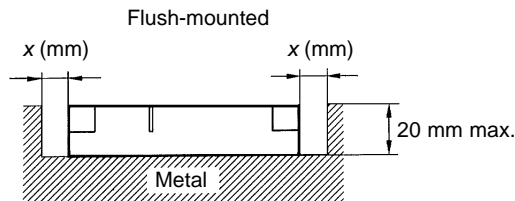

The restrictions illustrated in the above diagram apply when the V600-D8KR04 is flush-mounted in a metal casing.

### Transmission Area Diagrams

The following diagrams are representative examples. The unit of measurement used is mm.

V600-D8KR11 and V600-H11

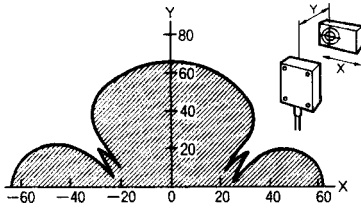

V600-D8KR12 and V600-H11

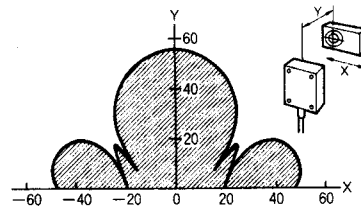

V600-D8KR13 and V600-H11

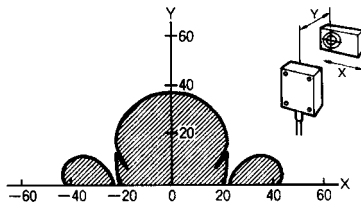

V600-D8KR04 and V600-H11

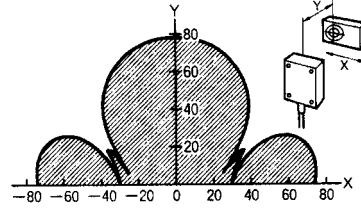

V600-D8KR11 and V600-H12

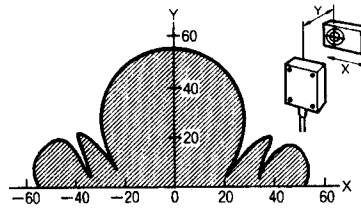

V600-D8KR12 and V600-H12

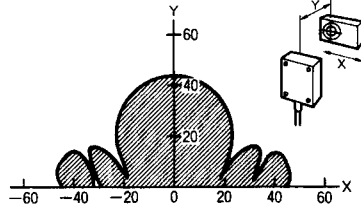

V600-D8KR13 and V600-H12

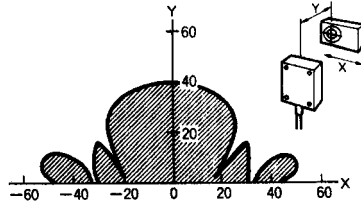

V600-D8KR04 and V600-H12

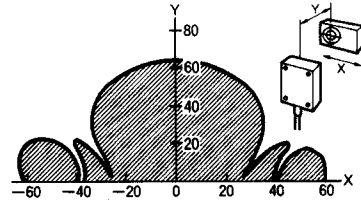

### Graph A

V600-H06/V600-D8KR04

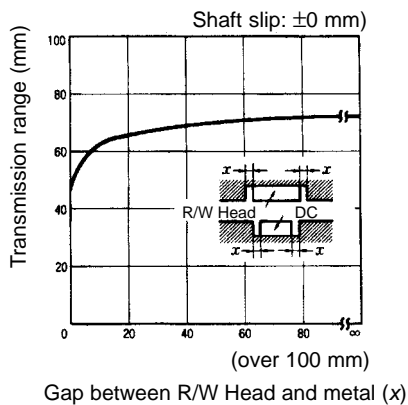

V600-H12/V600-D8KR04

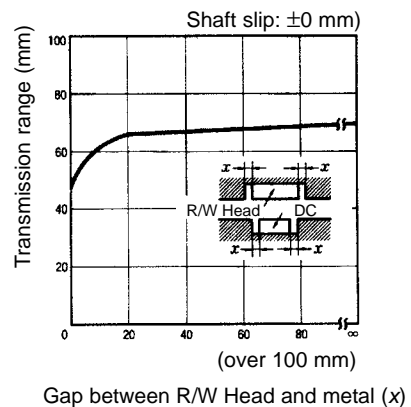



**Note** All mounting conditions shown here are for metal back panel mounting.

## Specifications and Performance of 500-kHz Models

### Data Carrier

V600-D2KR01, V600-D8KR01  
 V600-D2KR02, V600-D8KR02  
 V600-D2KR03, V600-D8KR03

Item	Model		
	V600-D2KR01 V600-D8KR01 	V600-D2KR02 V600-D8KR02 	V600-D2KR03 V600-D8KR03 
Memory capacity	2K bytes/8K bytes		
Memory type	SRAM (static random access memory)		
Battery service life	(Refer to transmission range specifications on following page.)		
Battery life (See note.)	8 years	5 years	8 years
Number of data read/write conversions	No limit (up to the extent of the battery service life)		
Error detection	16-bit CRC error detection is used in both directions of transmission.		
Operating temperature	-25°C to 70°C		
Storage temperature	-40°C to 70°C		
Operating humidity	35% to 95% RH		
Storage humidity	35% to 95% RH		
Degree of protection	Meets or exceeds IEC60529 IP67 and JEM IP67G standards for submersion and oil-resistance.		
Vibration resistance	10 to 500 Hz, 1.0 mm in each direction; acceleration: 150 m/s <sup>2</sup> (about 15 G); one sweep in each of three axis directions, three sweeps in 11 minutes		
Shock resistance	1,000 m/s <sup>2</sup> (about 100 G) three times each in X, Y, Z directions		
Dimensions	86 x 54 x 20 (mm)	65 x 40 x 15 (mm)	86 x 54 x 10.3 (mm)
Weight	Approx. 170 g	Approx. 70 g	

**Note** The battery service life shown here is the value that can be expected at 55°C, 100 bytes/access, and 1,000 accesses/day.

### R/W Head

V600-H06

Item	Model
	V600-H06 
Operating frequency	500 kHz
Operating temperature	-25°C to 70°C
Storage temperature	-40°C to 85°C
Operating humidity	35% to 95% RH
Storage humidity	35% to 95% RH
Degree of protection	Meets or exceeds IEC60529 IP67 and JEM IP67G standards for submersion and oil-resistance.
Vibration resistance	0 to 500 Hz, 1.0 mm in each direction; acceleration: 150 m/s <sup>2</sup> (about 15 G); one sweep in each of three axis directions, three sweeps in 11 minutes
Shock resistance	500 m/s <sup>2</sup> (about 50 G) three times in each direction
Dimensions	100 x 70 x 30 (mm)
Weight	Approx. 1 kg (with 10 m cable)

# Transmission Range Specifications (Recommended Operating Area)

## When Combined With V600-H06

Item			Model		
			V600-D2KR01 V600-D8KR01	V600-D2KR02 V600-D8KR02	V600-D2KR03 V600-D8KR03
Range	Stationary	Flush-mounted within metal	10 to 35 mm	5 to 25 mm	10 to 35 mm
	Moving	Surface-mounted on metal	15 to 45 mm	10 to 30 mm	15 to 40 mm
	Stationary	Flush-mounted within metal	20 to 35 mm	15 to 25 mm	20 to 35 mm
	Moving	Surface-mounted on metal	25 to 40 mm	20 to 30 mm	25 to 40 mm

(Shaft slip: ±10 mm)

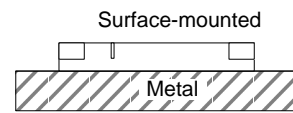
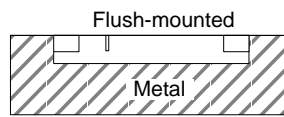

The transmission range in the specifications is satisfied even if the back panel is not metal.

## Transmission Area Diagrams

The following diagrams are representative examples. The unit of measurement used is mm.

V600-D□KR01 and V600-H06

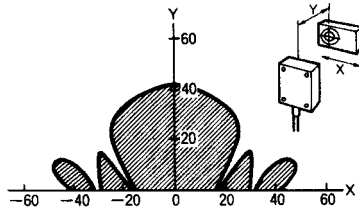

V600-D□KR02 and V600-H06

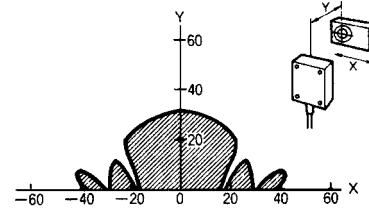

V600-D□KR03 and V600-H06

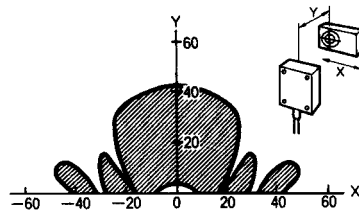

**Note** All mounting conditions shown here are for metal back panel mounting.

## Combining 500-kHz and 530-kHz Models

### Transmission Range Specifications (Recommended Operating Area)

It is possible to use 500-kHz models and 530-kHz models in combination, but the transmission ranges are different.

1) 500-KHz R/W Head Combined With 530-kHz DC

• Combined With V600-H06

Item			Model			
			V600-D8KR11	V600-D8KR12	V600-D8KR13	V600-D8KR04
Range	Stationary	Flush-mounted within metal	10 to 35 mm	5 to 25 mm	10 to 30 mm	Refer to Graph A and the transmission area diagrams.
	Moving	Surface-mounted on metal	15 to 40 mm	10 to 30 mm	15 to 35 mm	
	Stationary	Flush-mounted within metal	20 to 35 mm	15 to 25 mm	20 to 30 mm	
	Moving	Surface-mounted on metal	25 to 40 mm	20 to 30 mm	25 to 35 mm	

(Shaft slip: ±10 mm)

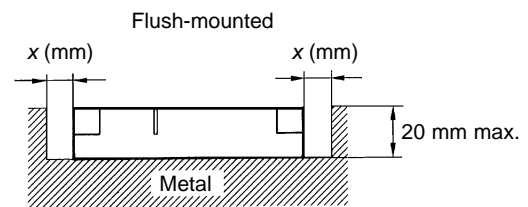
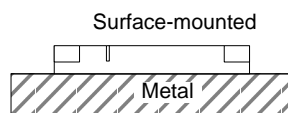
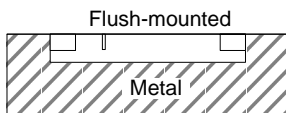

**Note** The transmission range in the specifications is satisfied even if the back panel is not metal.

**Note** The restrictions illustrated in the above diagram apply when the V600-D8KR04 is flush-mounted in a metal casing. (The data varies depending on range x.)

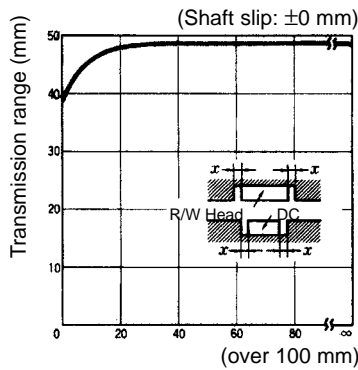

Gap between R/W Head and metal (x)

1) 530-KHz R/W Head Combined With 500-kHz DC

• Combined With V600-H12

Item			Model		
			V600-D2KR01 V600-D8KR01	V600-D2KR02 V600-D8KR02	V600-D2KR03 V600-D8KR03
Range	Stationary	Flush-mounted within metal	10 to 30 mm	5 to 20 mm	10 to 30 mm
	Moving	Surface-mounted on metal	15 to 35 mm	10 to 25 mm	15 to 35 mm
	Stationary	Flush-mounted within metal	20 to 30 mm	15 to 20 mm	20 to 30 mm
	Moving	Surface-mounted on metal	25 to 35 mm	20 to 25 mm	25 to 35 mm

(Shaft slip: ±10 mm)

• Combined With V600-H11

Item			Model		
			V600-D2KR01 V600-D8KR01	V600-D2KR02 V600-D8KR02	V600-D2KR03 V600-D8KR03
Range	Stationary	Flush-mounted within metal	5 to 25 mm	5 to 20 mm	5 to 20 mm
	Moving	Surface-mounted on metal	5 to 30 mm	5 to 25 mm	5 to 25 mm
	Stationary	Flush-mounted within metal	15 to 25 mm	15 to 20 mm	15 to 20 mm
	Moving	Surface-mounted on metal	15 to 30 mm	15 to 25 mm	15 to 25 mm

(Shaft slip: ±10 mm)

### Transmission Area Diagrams

The following diagrams are representative examples. The unit of measurement used is mm.

V600-D8KR11 and V600-H06

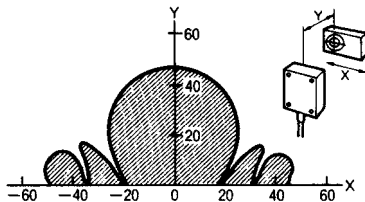

V600-D8KR12 and V600-H06

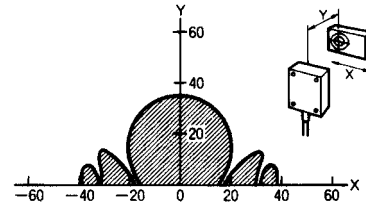

V600-D8KR13 and V600-H06

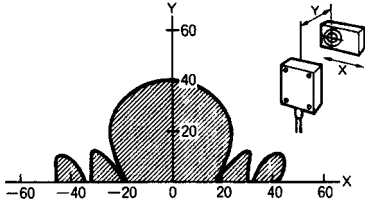

V600-D8KR04 and V600-H06

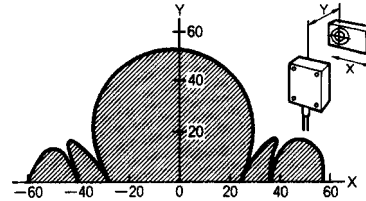

V600-D□KR01 and V600-H12

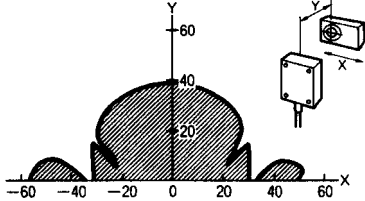

V600-D□KR02 and V600-H12

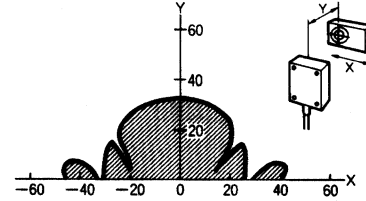

V600-D□KR03 and V600-H12

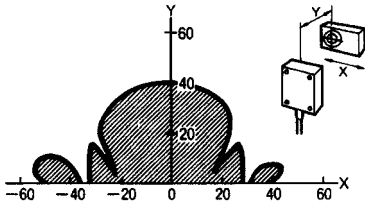

V600-D□KR01 and V600-H11

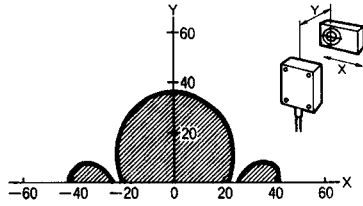

V600-D□KR02 and V600-H11

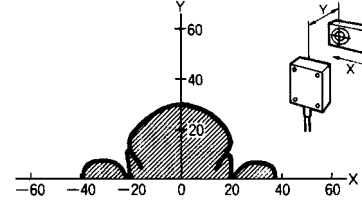

V600-D□KR03 and V600-H11

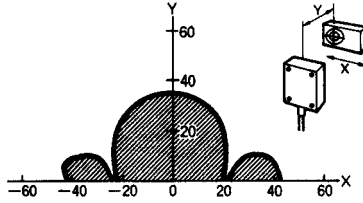

**Note** All mounting conditions shown here are for metal back panel mounting.

## Dimensions

### V600-H06/12

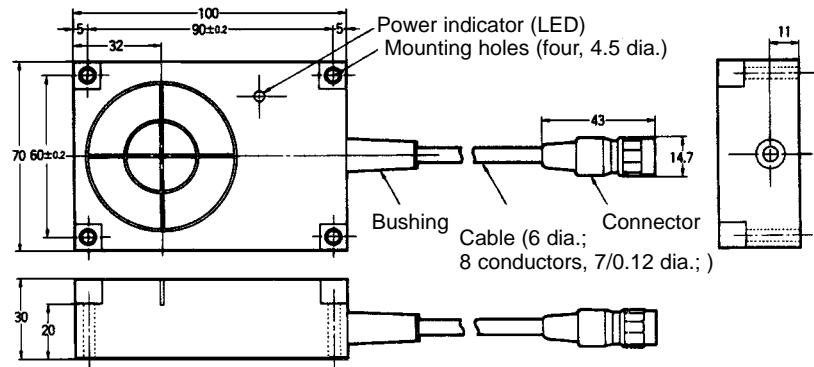

### V600-H11

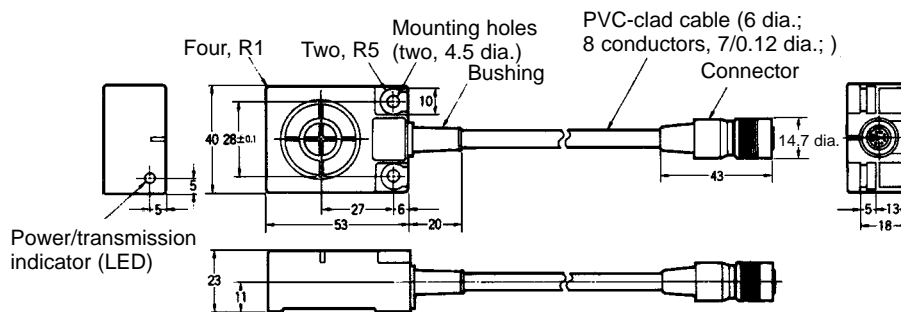

Case material	ABS resin
Fill resin	Epoxy resin
Cable	PVC (oil-resistant)

V600-D□KR01  
V600-D8KR11

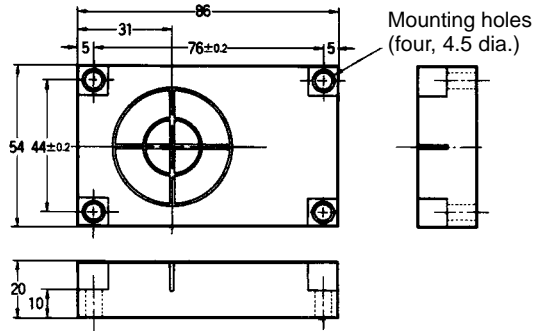

V600-D□KR02  
V600-D8KR12

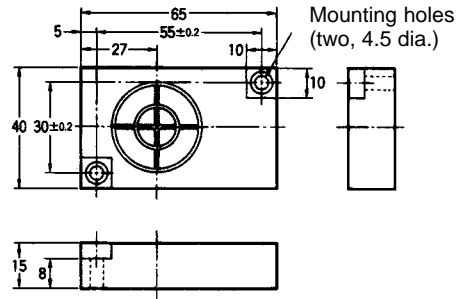

V600-D□KR03  
V600-D8KR13

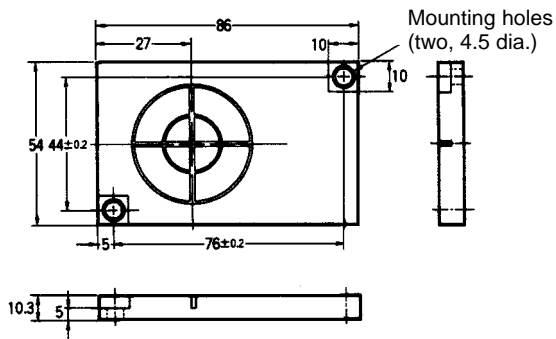

V600-D□KR04

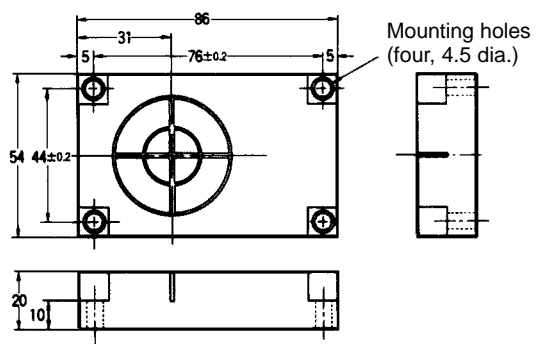

Case material	ABS resin
Fill resin	Epoxy resin



## Appendix C

### Other Series

In England, R/W Heads and Data Carriers with a transmission frequency of 470 kHz must be used.

Model: V600-H06-T (R/W Head)  
V600-D2KR01-T (Data Carrier)

Except for the transmission frequency, the specifications of the above 470-kHz models are exactly the same as those of the V600-H06 and V600-D2KR01. For details, refer to *Appendix B Discontinued Models and Replacements*.

## Revision History

A manual revision code appears as a suffix to the catalog number on the front cover of the manual.

Cat. No. Z127-E1-1

↑  
Revision code

The following table outlines the changes made to the manual during each revision. Page numbers refer to the previous version.

Revision code	Date	Revised content
1	August 1998	Original production



Компания «ЭлектроПласт» предлагает заключение долгосрочных отношений при поставках импортных электронных компонентов на взаимовыгодных условиях!

Наши преимущества:

- Оперативные поставки широкого спектра электронных компонентов отечественного и импортного производства напрямую от производителей и с крупнейших мировых складов;
- Поставка более 17-ти миллионов наименований электронных компонентов;
- Поставка сложных, дефицитных, либо снятых с производства позиций;
- Оперативные сроки поставки под заказ (от 5 рабочих дней);
- Экспресс доставка в любую точку России;
- Техническая поддержка проекта, помощь в подборе аналогов, поставка прототипов;
- Система менеджмента качества сертифицирована по Международному стандарту ISO 9001;
- Лицензия ФСБ на осуществление работ с использованием сведений, составляющих государственную тайну;
- Поставка специализированных компонентов (Xilinx, Altera, Analog Devices, Intersil, Interpoint, Microsemi, Aeroflex, Peregrine, Syfer, Eurofarad, Texas Instrument, Miteq, Cobham, E2V, MA-COM, Hittite, Mini-Circuits, General Dynamics и др.);

Помимо этого, одним из направлений компании «ЭлектроПласт» является направление «Источники питания». Мы предлагаем Вам помощь Конструкторского отдела:

- Подбор оптимального решения, техническое обоснование при выборе компонента;
- Подбор аналогов;
- Консультации по применению компонента;
- Поставка образцов и прототипов;
- Техническая поддержка проекта;
- Защита от снятия компонента с производства.



#### Как с нами связаться

**Телефон:** 8 (812) 309 58 32 (многоканальный)

**Факс:** 8 (812) 320-02-42

**Электронная почта:** [org@eplast1.ru](mailto:org@eplast1.ru)

**Адрес:** 198099, г. Санкт-Петербург, ул. Калинина, дом 2, корпус 4, литера А.