

Thermofit Molded Parts Specification Control Drawing

Part Number : 222D121 thru 196
Description : Boot, 90°, With Lip

NOTES

- All dimensions are in $\frac{\text{inches}}{\text{[millimeters]}}$
- Dimensions appearing in table are as follows:
 - a - As Supplied
 - b - After Unrestricted Recovery
- Coating is optional. As supplied dimensions appearing in table are for uncoated parts. When coating is added, entry diameters will be reduced by .06 max.
- Molding ports are optional. When -00 modification number is specified molding ports will be located as shown.
- * -8 material is not available on 222D185 and 222D196.

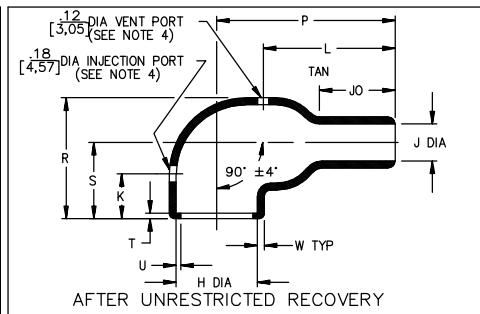
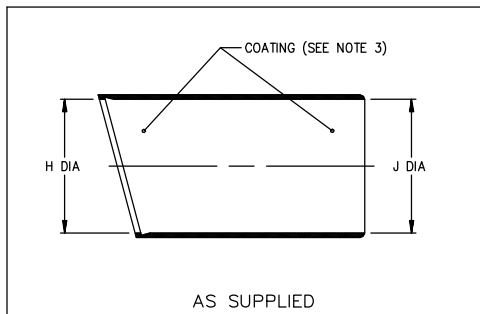

TABLE OF DIMENSIONS

PART NUMBER	H			J				P ±10% b	R Ref b	S Ref b	T Ref b	U Ref b	JO ±10% b	W ±20% b	K ±10% b	L ±10% b
	Min -8,-100 a	Min a	Max b	Min -8,-100 a	Min 3,-4,-25 a	Min -5,-6,-12 a	Max b									
222D121	.94 [24,0]	.92 [23,4]	.41 [10,4]	.55 [14,0]	.92 [23,4]	.49 [12,4]	.22 [5,6]	.84 [21,3]	.89 [22,6]	.65 [16,5]	.12 [3,0]	.04 [1,0]	.23 [5,8]	.05 [1,3]	.60 [15,2]	.58 [14,7]
222D132	1.18 [30,0]	1.12 [28,4]	.56 [14,2]	.59 [15,0]	1.12 [28,4]	.58 [14,7]	.26 [6,6]	1.33 [33,8]	1.07 [27,2]	.76 [19,3]	.12 [3,0]	.04 [1,0]	.65 [15,5]	.06 [1,5]	.75 [19,1]	.98 [24,9]
222D142	1.22 [31,0]	1.22 [31,0]	.70 [17,8]	.71 [18,0]	1.22 [31,0]	.63 [16,0]	.28 [7,1]	1.44 [36,6]	1.22 [31,0]	.83 [21,1]	.12 [3,0]	.04 [1,0]	.50 [12,7]	.07 [1,8]	.75 [19,1]	.98 [24,9]
222D152	1.42 [36,0]	1.42 [36,0]	.88 [22,4]	.83 [21,0]	1.42 [36,0]	.73 [18,5]	.33 [8,4]	1.72 [43,7]	1.38 [35,1]	.90 [22,9]	.12 [3,0]	.04 [1,0]	.57 [14,5]	.07 [1,8]	.75 [19,1]	1.18 [30,0]
222D163	1.69 [43,0]	1.68 [42,7]	1.11 [28,2]	.98 [25,0]	1.68 [42,7]	.87 [22,1]	.39 [9,9]	2.11 [53,6]	1.73 [43,9]	1.14 [29,0]	.12 [3,0]	.07 [1,7]	.69 [17,5]	.08 [2,0]	.76 [19,3]	1.30 [33,0]
222D174	2.05 [52,0]	2.04 [51,8]	1.38 [35,1]	1.54 [39,0]	2.04 [51,8]	1.39 [35,3]	.62 [15,7]	3.07 [78,0]	2.08 [52,8]	1.32 [33,5]	.12 [3,0]	.07 [1,7]	1.32 [33,5]	.13 [3,3]	1.00 [25,4]	2.12 [53,8]
* 222D185	2.60 [66,0]	2.60 [66,0]	1.75 [44,5]	1.65 [42,0]	2.60 [66,0]	1.80 [45,7]	.80 [20,3]	3.84 [97,5]	2.60 [66,0]	1.64 [41,7]	.12 [3,0]	.08 [2,0]	1.58 [40,1]	.15 [3,8]	1.00 [25,4]	2.80 [71,1]
* 222D196	3.22 [81,8]	3.22 [81,8]	2.38 [60,5]	2.25 [57,2]	3.22 [81,8]	2.25 [57,2]	1.00 [25,4]	4.64 [117,9]	3.30 [83,8]	2.03 [51,6]	.12 [3,0]	.08 [2,0]	1.50 [38,1]	.16 [4,1]	1.00 [25,4]	3.15 [80,0]

IF THIS DOCUMENT IS PRINTED IT BECOMES UNCONTROLLED. CHECK FOR THE LATEST REVISION.

STE TE Connectivity
300 Constitution Drive,
Menlo Park, CA 94025

Revision : R1
Date : 20APR11

Part Number : 222D121 thru 196
Description : Boot, 90°, With Lip

Thermofit Molded Parts Specification Control Drawing

Part Number : 222D121 thru 196
Description : Boot, 90°, With Lip

COMPATABILITY CHART

MATERIAL DASH NO.	MATERIAL DESCRIPTION	RT SPEC	COATING SLASH NO.	COATING S NO.	COATING DESCRIPTION
-3	Polyolefin, Semi-rigid	RT-301	/42;/86;/180	S-1017;S-1048;S-1030	Adhesive
-4	Polyolefin, Flexible	RT-1304	/42;/86;/180	S-1017;S-1048;S-1030	Adhesive
-5	Elastomer, Flexible	RT-501	N/A		
-6	Silicone	RT-602	N/A		
-8	Polyolefin, Space	RT-1308	N/A		
-12	*VITON, Flexible	RT-1312	N/A		
-25	Elastomer, Fluid Resistant	RT-1325	/86;/225	S-1048;S-1206	Adhesive
-100	Polyolefin, Semi-flexible ZEROHAL™	RT-1323	/86;/180;/184	S-1048;S-1030	Adhesive

*VITON is a Registered Trademark of Dupont

ORDERING INFORMATION

222D1XX -X -XX /XXX

Base part number _____
Material dash number _____
(See Compatibility Chart)
Modification number _____
(If necessary, see front of scd binder for a complete list)
Adhesive slash number _____
(If necessary, see Compatibility Chart)

THIS DRAWING IS SUBJECT TO CHANGE WITHOUT NOTICE; CONSULT YOUR NEAREST FIELD REPRESENTATIVE FOR CURRENT REVISION

IF THIS DOCUMENT IS PRINTED IT BECOMES UNCONTROLLED. CHECK FOR THE LATEST REVISION.

STE TE Connectivity
300 Constitution Drive,
Menlo Park, CA 94025
IF THIS DOCUMENT IS PRINTED IT BECOMES UNCONTROLLED. CHECK FOR THE LATEST REVISION.

Revision : R1
Date : 20APR11

Part Number : 222D121 thru 196
Description : Boot, 90°, With Lip

CAD FILE MP00112



Компания «ЭлектроПласт» предлагает заключение долгосрочных отношений при поставках импортных электронных компонентов на взаимовыгодных условиях!

Наши преимущества:

- Оперативные поставки широкого спектра электронных компонентов отечественного и импортного производства напрямую от производителей и с крупнейших мировых складов;
- Поставка более 17-ти миллионов наименований электронных компонентов;
- Поставка сложных, дефицитных, либо снятых с производства позиций;
- Оперативные сроки поставки под заказ (от 5 рабочих дней);
- Экспресс доставка в любую точку России;
- Техническая поддержка проекта, помощь в подборе аналогов, поставка прототипов;
- Система менеджмента качества сертифицирована по Международному стандарту ISO 9001;
- Лицензия ФСБ на осуществление работ с использованием сведений, составляющих государственную тайну;
- Поставка специализированных компонентов (Xilinx, Altera, Analog Devices, Intersil, Interpoint, Microsemi, Aeroflex, Peregrine, Syfer, Eurofarad, Texas Instrument, Miteq, Cobham, E2V, MA-COM, Hittite, Mini-Circuits, General Dynamics и др.);

Помимо этого, одним из направлений компании «ЭлектроПласт» является направление «Источники питания». Мы предлагаем Вам помощь Конструкторского отдела:

- Подбор оптимального решения, техническое обоснование при выборе компонента;
- Подбор аналогов;
- Консультации по применению компонента;
- Поставка образцов и прототипов;
- Техническая поддержка проекта;
- Защита от снятия компонента с производства.



Как с нами связаться

Телефон: 8 (812) 309 58 32 (многоканальный)

Факс: 8 (812) 320-02-42

Электронная почта: org@eplast1.ru

Адрес: 198099, г. Санкт-Петербург, ул. Калинина, дом 2, корпус 4, литера А.