

 EVALUATION KIT
AVAILABLE

Rail-to-Rail, 200kHz Op Amp with Shutdown in a Tiny, 6-Bump WLP

MAX44265

General Description

The MAX44265 op amp features a maximized ratio of gain bandwidth (GBW) to supply current and is ideal for battery-powered applications such as handsets, tablets, notebooks, and portable medical equipment. This CMOS op amp features an ultra-low input-bias current of 1pA, rail-to-rail input and output, low supply current of 4 μ A, and operates from a single 1.8V to 5.5V supply. For additional power conservation, the IC also features a low-power shutdown mode that reduces supply current to 1nA and puts the amplifier's outputs in a high-impedance state. This device is unity-gain stable with a 200kHz GBW product.

It is available in a space-saving, 0.9mm x 1.3mm, 6-bump WLP package and is specified over the -40°C to +85°C extended operating temperature range.

Applications

Cell Phones
Tablet/Notebook Computers
Mobile Accessories
Battery-Powered Devices

Features

- ◆ 200kHz GBW
- ◆ Ultra-Low 4 μ A Supply Current
- ◆ Single 1.8V to 5.5V Supply Voltage Range
- ◆ Ultra-Low 1pA Input Bias Current
- ◆ Rail-to-Rail Input and Output Voltage Ranges
- ◆ Low \pm 200 μ V Input Offset Voltage
- ◆ Low 0.001 μ A Shutdown Current
- ◆ High-Impedance Output During Shutdown
- ◆ Unity-Gain Stable
- ◆ Available in a Tiny, 0.9mm x 1.3mm, 6-Bump WLP Package

Ordering Information

PART	TEMP RANGE	PIN-PACKAGE	TOP MARK
MAX44265EWT+	-40°C to +85°C	6 WLP	+BY

Rail-to-Rail, 200kHz Op Amp with Shutdown in a Tiny, 6-Bump WLP

ABSOLUTE MAXIMUM RATINGS

Power-Supply Voltage (V_{DD} to V_{SS})-0.3V to +6.0V
 IN_+ , IN_- , OUT_+ , $\overline{SHDN_+}$ ($V_{SS} - 0.3V$) to ($V_{DD} + 0.3V$)
 Current into IN_+ , IN_- $\pm 20mA$
 Output Short-Circuit Duration to V_{DD} or V_{SS} Continuous
 Continuous Power Dissipation ($T_A = +70^\circ C$)
 6-Bump WLP (derate 10.5mW/ $^\circ C$ above +70 $^\circ C$)840mW

Operating Temperature Range -40 $^\circ C$ to +85 $^\circ C$
 Junction Temperature +150 $^\circ C$
 Storage Temperature Range -65 $^\circ C$ to +150 $^\circ C$
 Soldering Temperature (reflow) +260 $^\circ C$

Stresses beyond those listed under "Absolute Maximum Ratings" may cause permanent damage to the device. These are stress ratings only, and functional operation of the device at these or any other conditions beyond those indicated in the operational sections of the specifications is not implied. Exposure to absolute maximum rating conditions for extended periods may affect device reliability.

ELECTRICAL CHARACTERISTICS

($V_{DD} = 1.8V$ to $5.5V$, $V_{SS} = 0V$, $V_{CM} = 0V$, $V_{OUT} = V_{DD}/2$, $R_L = \infty$ connected to $V_{DD}/2$, $\overline{SHDN_+} = V_{DD}$, $T_A = +25^\circ C$, unless otherwise noted.) (Note 1)

PARAMETER	SYMBOL	CONDITIONS	MIN	TYP	MAX	UNITS
Supply Voltage Range	V_{DD}	Guaranteed by PSRR test	1.8		5.5	V
Supply Current	I_{DD}	$V_{DD} = 1.8V$		4		μA
		$V_{DD} = 5.5V$		4	5.0	
Shutdown Supply Current	$I_{DD}(\overline{SHDN_+})$	$\overline{SHDN_+} = GND$		0.001	0.5	μA
Input Offset Voltage	V_{OS}			± 0.2	± 1	mV
Input Bias Current	I_B	(Note 2)		± 1	± 10	pA
Input Offset Current	I_{OS}	(Note 2)		± 1	± 10	pA
Input Resistance	R_{IN}	Common mode		1		$G\Omega$
		Differential mode, $-1mV < V_{IN} < +1mV$		10		
Input Common-Mode Range	V_{CM}	Guaranteed by CMRR test	$V_{SS} - 0.1$		$V_{DD} + 0.1$	V
Common-Mode Rejection Ratio	CMRR	$-0.1V < V_{CM} < V_{DD} + 0.1V$, $V_{DD} = 5.5V$	70	80		dB
Power-Supply Rejection Ratio	PSRR	$1.8V < V_{DD} < 5.5V$	65	95		dB
Open-Loop Gain	A_{VOL}	$25mV < V_{OUT} < V_{DD} - 25mV$, $R_L = 100k\Omega$, $V_{DD} = 5.5V$	95	120		dB
		$100mV < V_{OUT} < V_{DD} - 100mV$, $R_L = 5k\Omega$, $V_{DD} = 5.5V$	95	110		
Output-Voltage-Swing High	V_{OH}	$V_{DD} - V_{OUT}$	$R_L = 100k\Omega$	2.5	5	mV
			$R_L = 5k\Omega$	50	70	
			$R_L = 1k\Omega$	250		
Output-Voltage-Swing Low	V_{OL}	$V_{OUT} - V_{SS}$	$R_L = 100k\Omega$	2.5	5	mV
			$R_L = 5k\Omega$	50	70	
			$R_L = 1k\Omega$	250		
Output Short-Circuit Current	$I_{OUT(SC)}$			± 15		mA

Rail-to-Rail, 200kHz Op Amp with Shutdown in a Tiny, 6-Bump WLP

MAX44265

ELECTRICAL CHARACTERISTICS (continued)

($V_{DD} = 1.8V$ to $5.5V$, $V_{SS} = 0V$, $V_{CM} = 0V$, $V_{OUT} = V_{DD}/2$, $R_L = \infty$ connected to $V_{DD}/2$, $\overline{SHDN_} = V_{DD}$, $T_A = +25^\circ C$, unless otherwise noted.) (Note 1)

PARAMETER	SYMBOL	CONDITIONS	MIN	TYP	MAX	UNITS
$\overline{SHDN_}$ Logic Low	V_{IL}	$V_{DD} = 1.8V$ to $3.6V$			0.4	V
		$V_{DD} = 3.6V$ to $5.5V$			0.8	
$\overline{SHDN_}$ Logic High	V_{IH}	$V_{DD} = 1.8V$ to $3.6V$	1.4			V
		$V_{DD} = 3.6V$ to $5.5V$	2			
$\overline{SHDN_}$ Input Bias Current	I_{IL}	$\overline{SHDN_} = V_{SS}$ (Note 2)			1	nA
	I_{IH}	$\overline{SHDN_} = V_{DD}$			500	
Output Leakage in Shutdown	$I_{OUT(\overline{SHDN_})}$	$\overline{SHDN_} = V_{SS}$, $V_{OUT} = 0V$ to V_{DD}		1	500	nA
Gain-Bandwidth Product				200		kHz
Slew Rate				0.1		V/ μs
Capacitive-Load Stability (See the <i>Driving Capacitive Loads</i> Section)	C_{LOAD}	No sustained oscillations	$A_V = 1V/V$		30	pF
			$A_V = 10V/V$		250	
			$R_L = 5k\Omega$, $A_V = 1V/V$		200	
			$R_{ISO} = 1k\Omega$, $A_V = 1V/V$		100	
Input Voltage-Noise Density		$f = 1kHz$		400		nV/ \sqrt{Hz}
Input Current-Noise Density		$f = 1kHz$		0.001		pA/ \sqrt{Hz}
Settling Time		To 0.1%, $V_{OUT} = 2V$ step, $A_V = -1V/V$		18		μs
Delay Time to Shutdown	t_{SH}	$I_{DD} = 5\%$ of normal operation, $V_{DD} = 5.5V$, $\overline{VSHDN_} = 5.5V$ to 0 step		2		μs
Delay Time to Enable	t_{EN}	$V_{OUT} = 2.7V$, V_{OUT} settles to 0.1%, $V_{DD} = 5.5V$, $\overline{VSHDN_} = 0$ to 5.5V step		30		μs
Power-Up Time		$V_{DD} = 0$ to 5.5V step		5		μs

ELECTRICAL CHARACTERISTICS

($V_{DD} = 1.8V$ to $5.5V$, $V_{SS} = 0V$, $V_{CM} = 0V$, $V_{OUT} = V_{DD}/2$, $R_L = \infty$ connected to $V_{DD}/2$, $\overline{SHDN_} = V_{DD}$, $T_A = -40^\circ C$ to $+85^\circ C$, unless otherwise noted.) (Note 1)

PARAMETER	SYMBOL	CONDITIONS	MIN	TYP	MAX	UNITS
Supply Voltage Range	V_{DD}	Guaranteed by PSRR test	1.8		5.5	V
Supply Current	I_{DD}	$V_{DD} = 5.5V$			5.5	μA
Shutdown Supply Current	$I_{DD(\overline{SHDN_})}$	$\overline{SHDN_} = GND$			1	μA
Input Offset Voltage	V_{OS}				± 5	mV
Input-Offset-Voltage Temperature Coefficient	TC_{VOS}			± 5		$\mu V/^\circ C$

Rail-to-Rail, 200kHz Op Amp with Shutdown in a Tiny, 6-Bump WLP

ELECTRICAL CHARACTERISTICS (continued)

($V_{DD} = 1.8V$ to $5.5V$, $V_{SS} = 0V$, $V_{CM} = 0V$, $V_{OUT} = V_{DD}/2$, $R_L = \infty$ connected to $V_{DD}/2$, $\overline{SHDN}_- = V_{DD}$, $T_A = -40^\circ C$ to $+85^\circ C$, unless otherwise noted.) (Note 1)

PARAMETER	SYMBOL	CONDITIONS	MIN	TYP	MAX	UNITS
Input Bias Current	I_B				± 30	pA
Input Offset Current	I_{OS}				± 20	pA
Input Common-Mode Range	V_{CM}	Guaranteed by CMRR test	$V_{SS} - 0.05$		$V_{DD} + 0.05$	V
Common-Mode Rejection Ratio	CMRR	$-0.05V < V_{CM} < V_{DD} + 0.05V$, $V_{DD} = 5.5V$	60			dB
Power-Supply Rejection Ratio	PSRR	$1.8V < V_{DD} < 5.5V$	59			dB
Open-Loop Gain	A_{VOL}	$25mV < V_{OUT} < V_{DD} - 25mV$, $R_L = 100k\Omega$, $V_{DD} = 5.5V$	85			dB
		$150mV < V_{OUT} < V_{DD} - 150mV$, $R_L = 5k\Omega$, $V_{DD} = 5.5V$	80			
Output-Voltage-Swing High	V_{OH}	$V_{DD} - V_{OUT}$	$R_L = 100k\Omega$		5	mV
			$R_L = 5k\Omega$		90	
Output-Voltage-Swing Low	V_{OL}	$V_{OUT} - V_{SS}$	$R_L = 100k\Omega$		5	mV
			$R_L = 5k\Omega$		90	
\overline{SHDN}_- Logic Low	V_{IL}	$V_{DD} = 1.8V$ to $3.6V$			0.4	V
		$V_{DD} = 3.6V$ to $5.5V$			0.8	
\overline{SHDN}_- Logic High	V_{IH}	$V_{DD} = 1.8V$ to $3.6V$	1.4			V
		$V_{DD} = 3.6V$ to $5.5V$	2			
\overline{SHDN}_- Input-Bias Current	I_{IL}	$\overline{SHDN}_- = V_{SS}$			5	nA
	I_{IH}	$\overline{SHDN}_- = V_{DD}$			1000	nA
Output Leakage in Shutdown	$I_{OUT(\overline{SHDN}_-)}$	$\overline{SHDN}_- = V_{SS}$, $V_{OUT} = 0V$ to V_{DD}			1000	nA

Note 1: Specifications are 100% tested at $T_A = +25^\circ C$ (exceptions noted). All temperature limits are guaranteed by design.

Note 2: Guaranteed by design, not production tested.

Rail-to-Rail, 200kHz Op Amp with Shutdown in a Tiny, 6-Bump WLP

Typical Operating Characteristics

($V_{DD} = 3V$, $V_{SS} = V_{CM} = 0V$, R_L to $V_{DD}/2$, $T_A = +25^\circ C$, unless otherwise noted.)

MAX44265

SUPPLY CURRENT vs. SUPPLY VOLTAGE

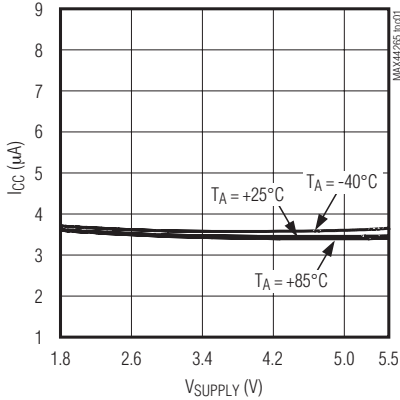

SHUTDOWN SUPPLY CURRENT vs. TEMPERATURE

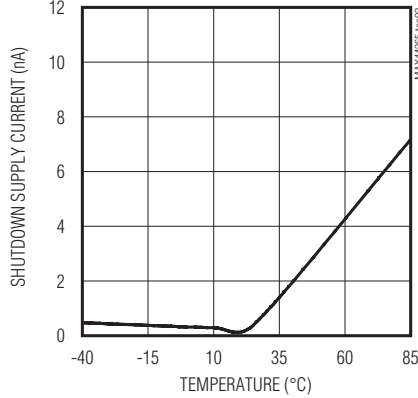

INPUT OFFSET VOLTAGE vs. INPUT COMMON-MODE VOLTAGE

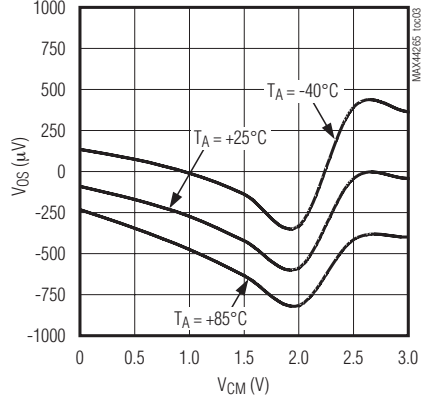

INPUT OFFSET VOLTAGE vs. TEMPERATURE

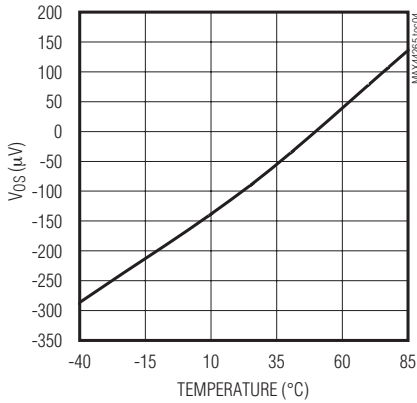

INPUT BIAS CURRENT vs. TEMPERATURE

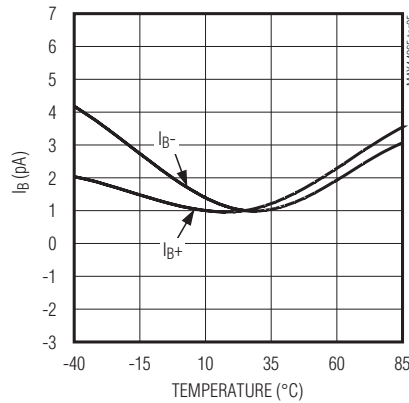

INPUT BIAS CURRENT vs. INPUT COMMON-MODE VOLTAGE

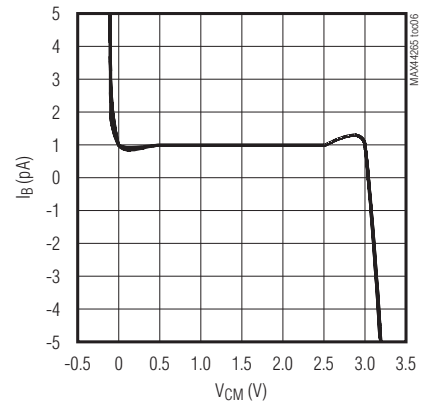

POWER-SUPPLY REJECTION RATIO vs. FREQUENCY

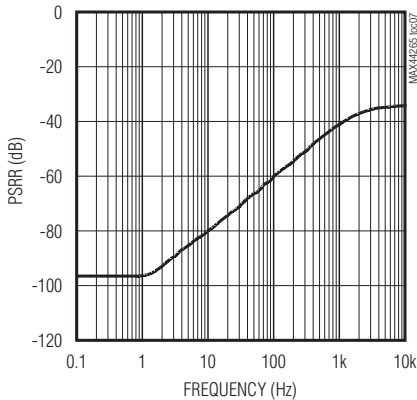

COMMON-MODE REJECTION RATIO vs. TEMPERATURE

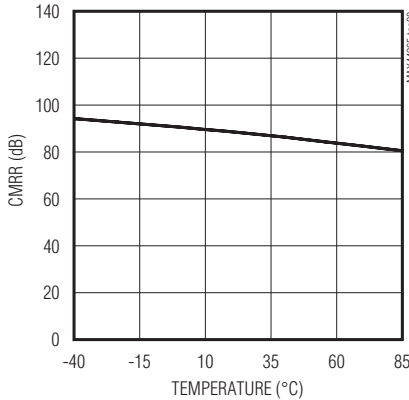

COMMON-MODE REJECTION RATIO vs. FREQUENCY

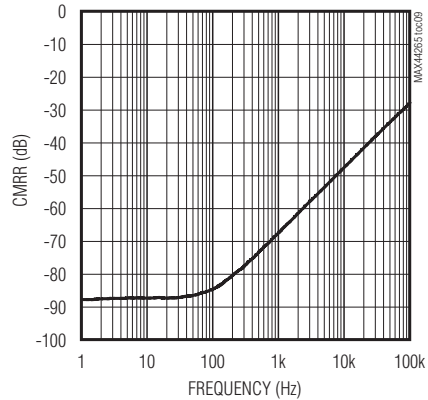

Rail-to-Rail, 200kHz Op Amp with Shutdown in a Tiny, 6-Bump WLP

Typical Operating Characteristics (continued)

($V_{DD} = 3V$, $V_{SS} = V_{CM} = 0V$, R_L to $V_{DD}/2$, $T_A = +25^\circ C$, unless otherwise noted.)

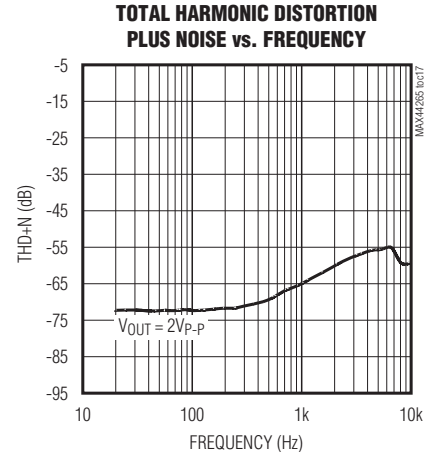
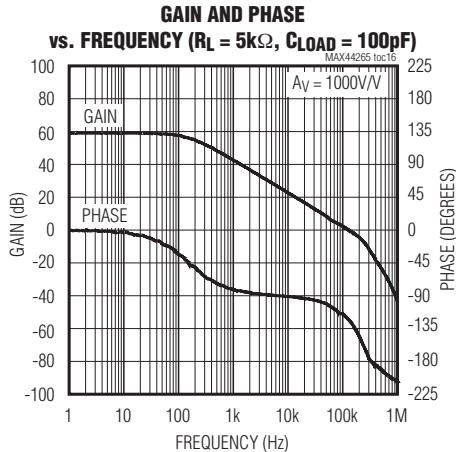
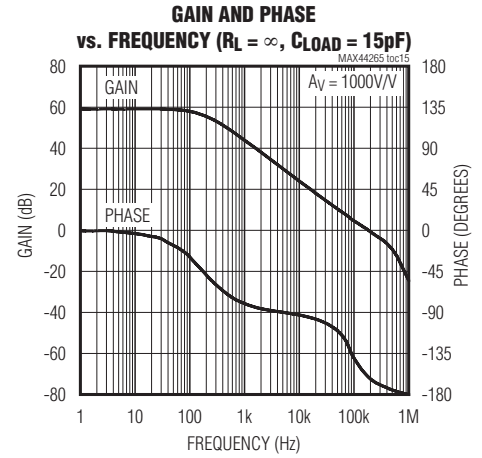
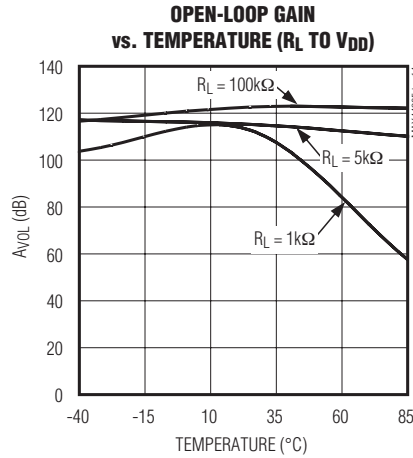
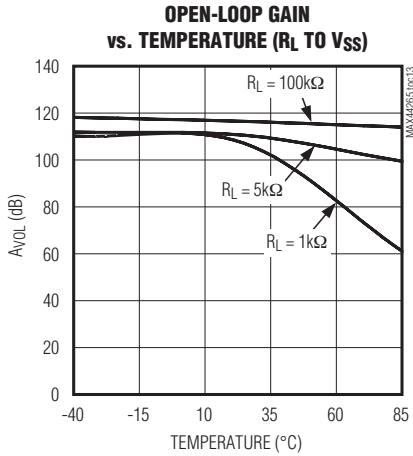
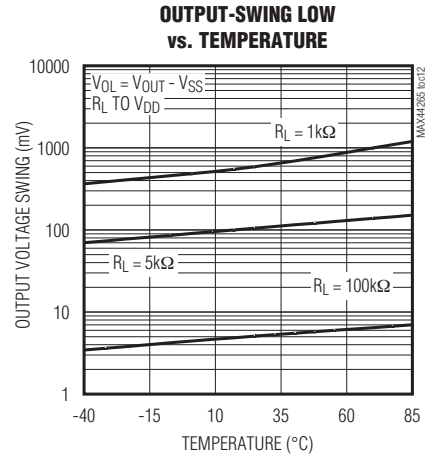
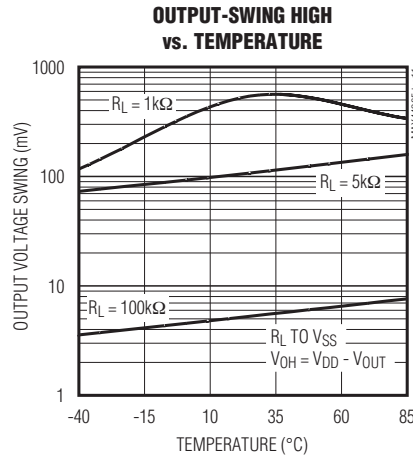
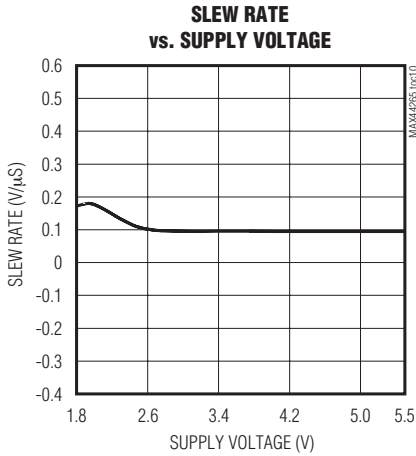

Rail-to-Rail, 200kHz Op Amp with Shutdown in a Tiny, 6-Bump WLP

MAX44265

Typical Operating Characteristics (continued)

($V_{DD} = 3V$, $V_{SS} = V_{CM} = 0V$, R_L to $V_{DD}/2$, $T_A = +25^\circ C$, unless otherwise noted.)

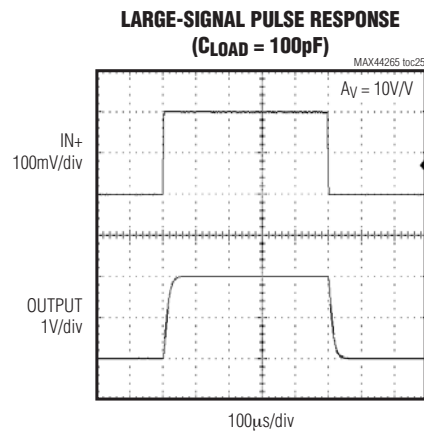
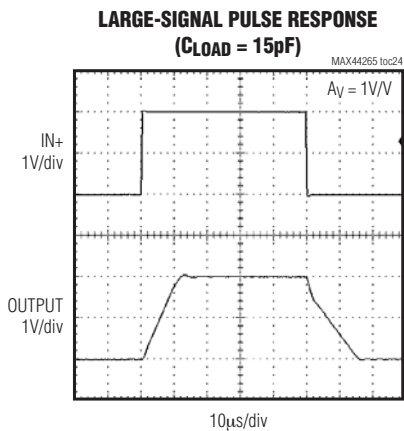
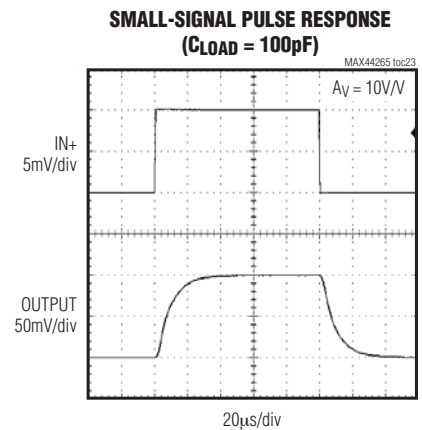
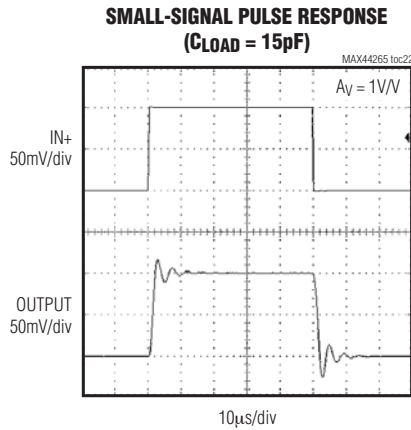
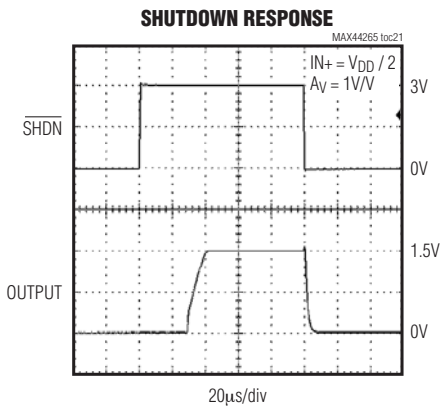
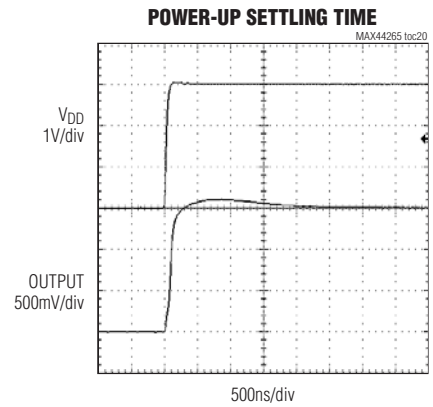
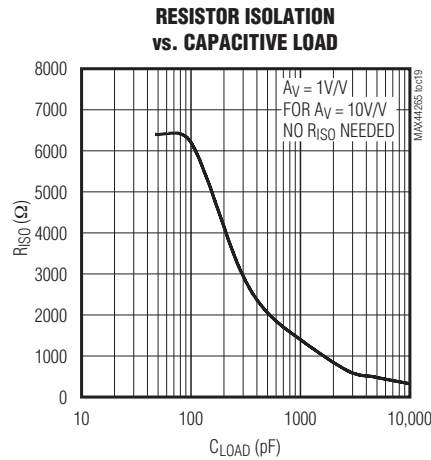
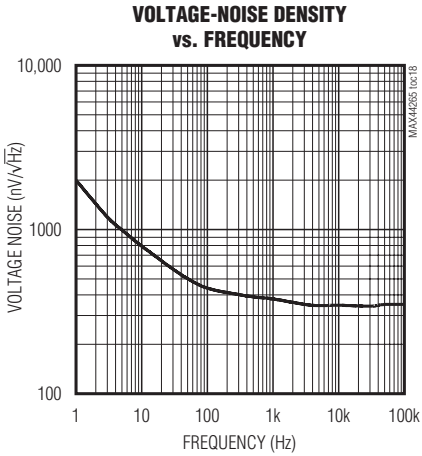

Rail-to-Rail, 200kHz Op Amp with Shutdown in a Tiny, 6-Bump WLP

Typical Operating Characteristics (continued)

($V_{DD} = 3V$, $V_{SS} = V_{CM} = 0V$, R_L to $V_{DD}/2$, $T_A = +25^\circ C$, unless otherwise noted.)

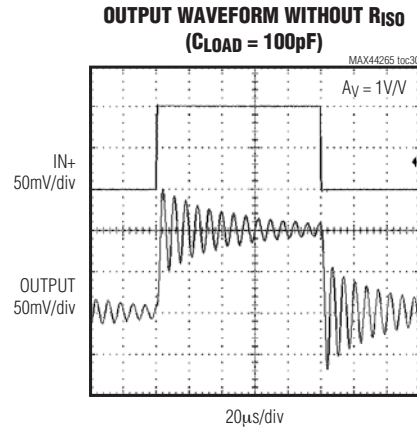
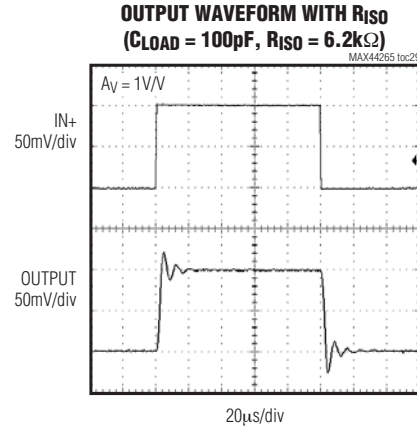
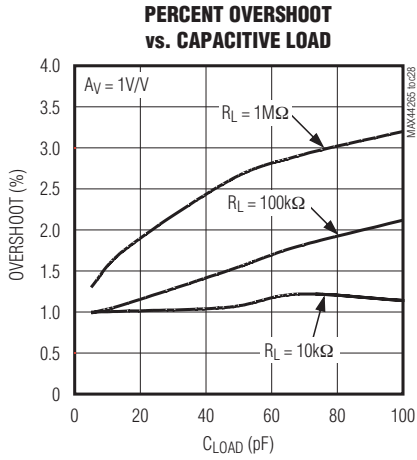
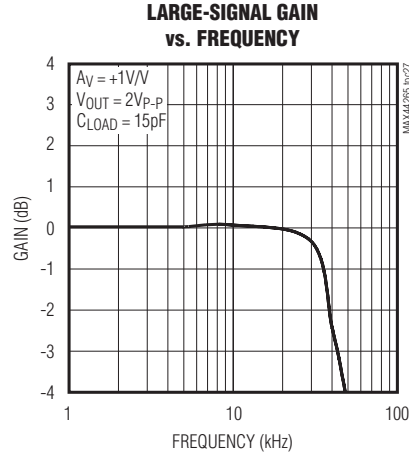
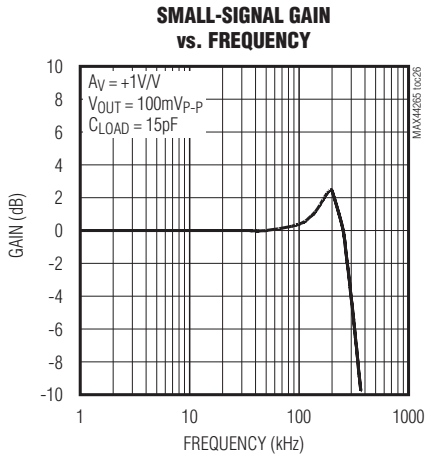

Rail-to-Rail, 200kHz Op Amp with Shutdown in a Tiny, 6-Bump WLP

MAX44265

Pin Configuration

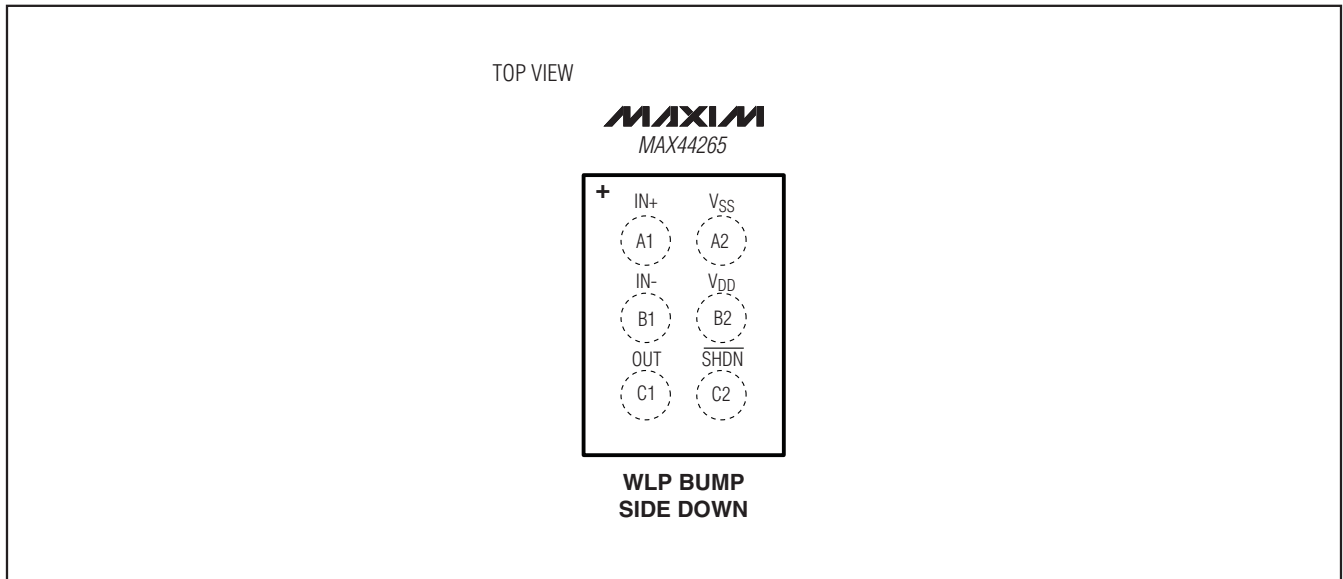

Pin Description

PIN	NAME	FUNCTION
A1	IN+	Noninverting Amplifier Input
A2	VSS	Negative Supply Voltage
B1	IN-	Inverting Amplifier Input
C1	OUT	Amplifier Output
B2	VDD	Positive Supply Voltage
C2	SHDN	Shutdown

Rail-to-Rail, 200kHz Op Amp with Shutdown in a Tiny, 6-Bump WLP

Detailed Description

Featuring a maximized ratio of GBW to supply current, low operating supply voltage, low input bias current, and rail-to-rail inputs and outputs, the MAX44265 is an excellent choice for precision or general-purpose, low-current, low-voltage, battery-powered applications. This CMOS device consumes an ultra-low 4 μ A (typ) supply current and has a 200 μ V (typ) offset voltage. For additional power conservation, the IC features a low-power shutdown mode that reduces supply current to 1nA (typ) and puts the amplifier's output in a high-impedance state. This device is unity-gain stable with a 200kHz GBW product, driving capacitive loads up to 30pF. The capacitive load can be increased to 250pF when the amplifier is configured for a 10V/V gain when the amplifier is configured for a 10V/V gain.

Rail-to-Rail Inputs and Outputs

The IC has a parallel-connected n- and p-channel differential input stage that allows an input common-mode voltage range that extends 100mV beyond the positive and negative supply rails, with excellent common-mode rejection. The IC is capable of driving the output to within 5mV of both supply rails with a 100k Ω load. This device can drive a 5k Ω load with swings to within 60mV of the rails. Figure 1 shows the output voltage swing of the IC configured as a unity-gain buffer powered from a single 3V supply.

Low Input Bias Current

The IC features ultra-low 1pA (typ) input bias current. The variation in the input bias current is minimal with changes in the input voltage due to very high input impedance (in the order of 1G Ω).

Applications Information

Driving Capacitive Loads

The IC's amplifier is unity-gain stable for loads up to 30pF. However, the capacitive load can be increased to 250pF when the amplifier is configured for a minimum gain of 10V/V. Applications that require greater capacitive-drive capability should use an isolation resistor between the output and the capacitive load (Figure 2). Also, in unity-gain applications with relatively small R_L (approximately 5k Ω), the capacitive load can be increased up to 200pF.

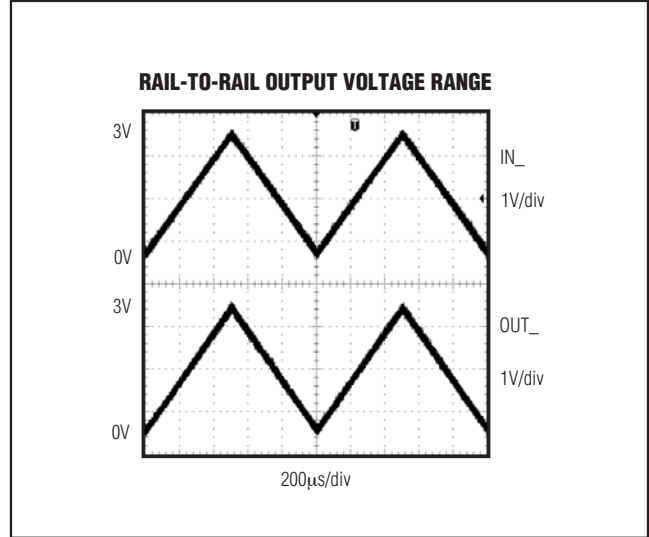

Figure 1. Rail-to-Rail Output Voltage Range

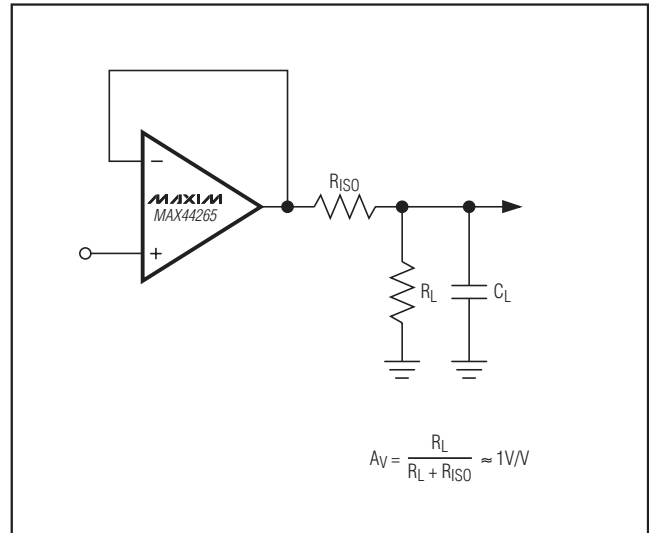

Figure 2. Using a Resistor to Isolate a Capacitive Load from the Op Amp

Rail-to-Rail, 200kHz Op Amp with Shutdown in a Tiny, 6-Bump WLP

MAX44265

Power-Supply Considerations

The IC is optimized for single 1.8V to 5.5V supply operation. A high amplifier power-supply rejection ratio of 95dB (typ) allows the devices to be powered directly from a battery, simplifying design and extending battery life.

Power-Up Settling Time

The IC typically requires 5 μ s after power-up. Supply settling time depends on the supply voltage, the value of the bypass capacitor, the output impedance of the incoming supply, and any lead resistance or inductance between components. Op-amp settling time depends primarily on the output voltage and is slew-rate limited. Figure 3 shows MAX44265 in a noninverting voltage follower configuration with the input held at midsupply. The output settles in approximately 18 μ s for $V_{DD} = 3V$ (see the *Typical Operating Characteristics* for power-up settling time).

Shutdown Mode

The IC features an active-low shutdown input. The device enters shutdown in 2 μ s (typ) and exit in 30 μ s (typ). The amplifier's outputs are in a high-impedance state in shutdown mode. Drive \overline{SHDN} low to enter shutdown. Drive \overline{SHDN} high to enable the amplifier.

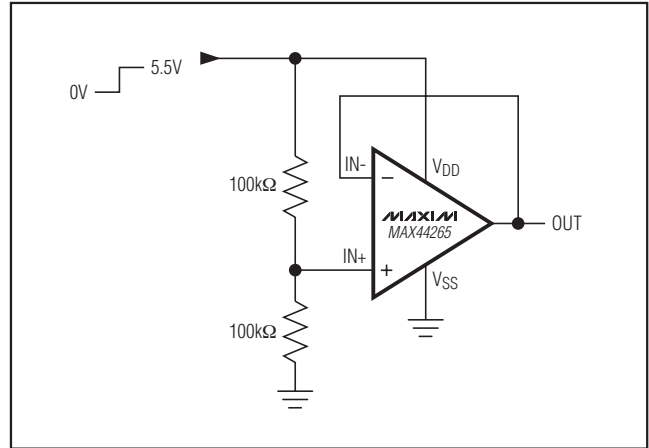

Figure 3. Power-Up Test Configuration

Power-Supply Bypassing and Layout

To minimize noise, bypass V_{DD} with a 0.1 μ F capacitor to ground, as close to the pin as possible.

Good layout techniques optimize performance by decreasing the amount of stray capacitance and inductance to the op amps' inputs and outputs. Minimize stray capacitance and inductance by placing external components close to the IC.

Chip Information

PROCESS: BiCMOS

Rail-to-Rail, 200kHz Op Amp with Shutdown in a Tiny, 6-Bump WLP

Package Information

For the latest package outline information and land patterns, go to www.maxim-ic.com/packages. Note that a "+", "#", or "-" in the package code indicates RoHS status only. Package drawings may show a different suffix character, but the drawing pertains to the package regardless of RoHS status.

PACKAGE TYPE	PACKAGE CODE	OUTLINE NO.	LAND PATTERN NO.
6 WLP	W61B1+1	21-0217	—

TOP VIEW

SIDE VIEW

COMMON DIMENSIONS	
A	0.64±0.05
A1	0.19±0.03
A2	0.45 REF
A3	0.025 BASIC
A4	0.07 BASIC
b	∅0.27±0.03
D1	0.80 BASIC
E1	0.40 BASIC
e	0.40 BASIC
SD	0.00 BASIC
SE	0.20 BASIC

PKG. CODE	E		D		DEPOPULATED BUMPS
	MIN	MAX	MIN	MAX	
W61B1+1	0.76	0.97	1.17	1.37	NONE
W61D1+1	0.95	1.02	1.36	1.42	NONE

BOTTOM VIEW

NOTES:

- Terminal pitch is defined by terminal center to center value.
- Outer dimension is defined by center lines between scribe lines.
- All dimensions in millimeters.
- Marking shown is for package orientation reference only.
- Tolerance is ± 0.02mm unless specified otherwise.
- All dimensions apply to PbFree (+) package codes only.

TITLE:
PACKAGE OUTLINE
6 BUMPS, WLP PKG. 0.4mm PITCH

APPROVAL	DOCUMENT CONTROL NO. 21-0217	REV. B	1/1
----------	---------------------------------	-----------	-----

-DRAWING NOT TO SCALE-

Rail-to-Rail, 200kHz Op Amp with Shutdown in a Tiny, 6-Bump WLP

Revision History

REVISION NUMBER	REVISION DATE	DESCRIPTION	PAGES CHANGED
0	12/10	Initial release	—

MAX44265

Maxim cannot assume responsibility for use of any circuitry other than circuitry entirely embodied in a Maxim product. No circuit patent licenses are implied. Maxim reserves the right to change the circuitry and specifications without notice at any time.

Maxim Integrated Products, 120 San Gabriel Drive, Sunnyvale, CA 94086 408-737-7600 _____ 13



Компания «ЭлектроПласт» предлагает заключение долгосрочных отношений при поставках импортных электронных компонентов на взаимовыгодных условиях!

Наши преимущества:

- Оперативные поставки широкого спектра электронных компонентов отечественного и импортного производства напрямую от производителей и с крупнейших мировых складов;
- Поставка более 17-ти миллионов наименований электронных компонентов;
- Поставка сложных, дефицитных, либо снятых с производства позиций;
- Оперативные сроки поставки под заказ (от 5 рабочих дней);
- Экспресс доставка в любую точку России;
- Техническая поддержка проекта, помощь в подборе аналогов, поставка прототипов;
- Система менеджмента качества сертифицирована по Международному стандарту ISO 9001;
- Лицензия ФСБ на осуществление работ с использованием сведений, составляющих государственную тайну;
- Поставка специализированных компонентов (Xilinx, Altera, Analog Devices, Intersil, Interpoint, Microsemi, Aeroflex, Peregrine, Syfer, Eurofarad, Texas Instrument, Miteq, Cobham, E2V, MA-COM, Hittite, Mini-Circuits, General Dynamics и др.);

Помимо этого, одним из направлений компании «ЭлектроПласт» является направление «Источники питания». Мы предлагаем Вам помощь Конструкторского отдела:

- Подбор оптимального решения, техническое обоснование при выборе компонента;
- Подбор аналогов;
- Консультации по применению компонента;
- Поставка образцов и прототипов;
- Техническая поддержка проекта;
- Защита от снятия компонента с производства.



Как с нами связаться

Телефон: 8 (812) 309 58 32 (многоканальный)

Факс: 8 (812) 320-02-42

Электронная почта: org@eplast1.ru

Адрес: 198099, г. Санкт-Петербург, ул. Калинина, дом 2, корпус 4, литера А.