

FEATURES

- Advanced programmable PLL design
- Very low Jitter and Phase Noise (30-70ps Pk-Pk typical)
- Up to 3 programmable outputs
- Output frequency up to 200MHz CMOS.
- Accepts Crystal or reference clock inputs
 - Fundamental crystal: 10MHz-30MHz
 - 3RD overtone crystal: Up to 75MHz
 - Reference input: Up to 200MHz
- Accepts <1.0V reference signal input voltage
- One programmable I/O pin can be configured as Programmable clock, or Frequency Selection input, or output Enable (OE) or Power Down (PDB) input.
- Supply operating range 2.25V to 3.63V
- Operating temperature range from -40°C to 85°C
- Available in 8-pin MSOP/SOP, and 6-pin SOT Green/ RoHS compliant Packages

PIN CONFIGURATION

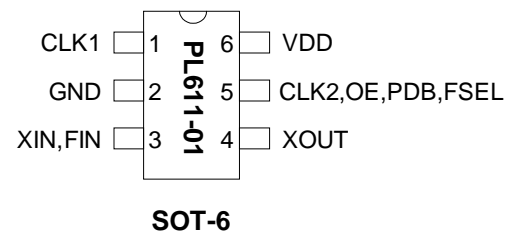
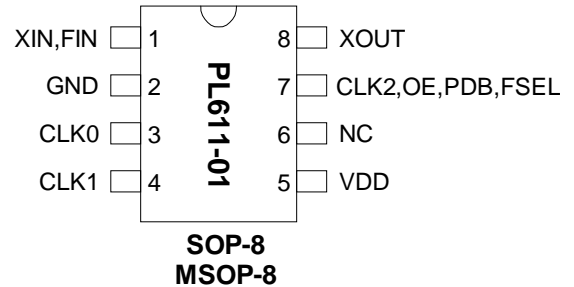

DESCRIPTION

The PL611-01 is a low-cost general purpose frequency synthesizer and a member of Programmable Clock family. PL611-01 product family offers the versatility of using a single Crystal or Reference Clock input and producing up to three different system clocks. They can generate any output frequency up to 200 MHz from fundamental crystal input between 10 MHz - 30 MHz, or a 3rd overtone crystal of up to 75MHz, or a Reference clock input of up to 200 MHz. Cascading of the ICs to produce additional clock frequencies is also supported.

BLOCK DIAGRAM

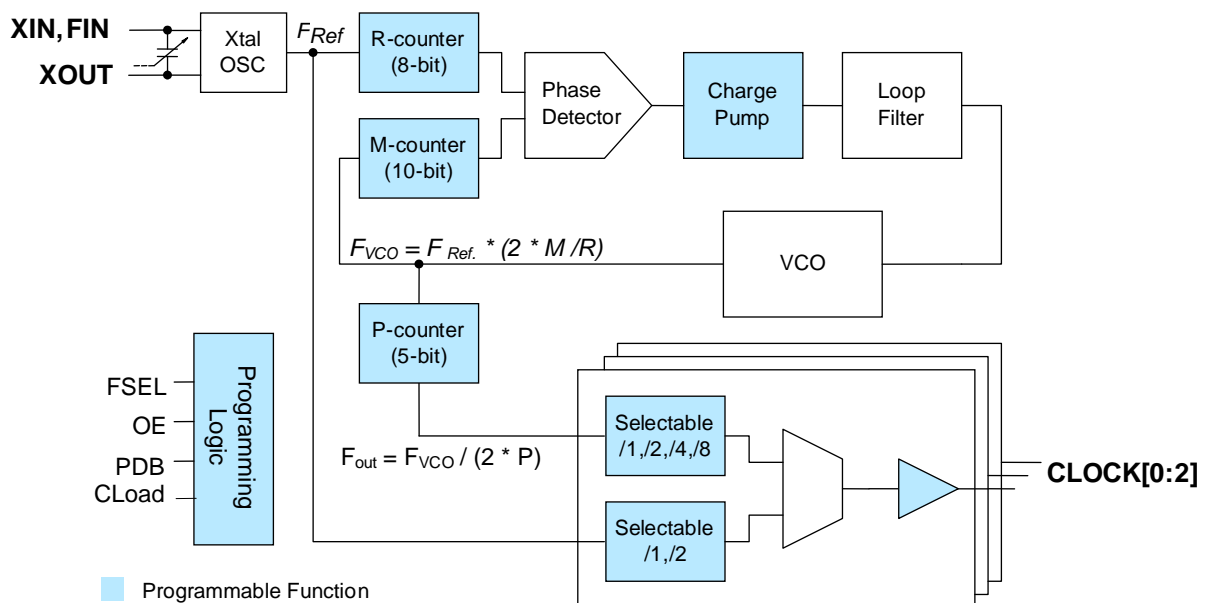

KEY PROGRAMMING PARAMETERS

| CLK[0:2] Output Frequency | Output Drive Strength | Crystal Load | Programmable Input/Output | Charge-Pump Current |
|--|---------------------------------------|--------------------|---|-----------------------------------|
| $F_{OUT} = F_{REF} * M / (R * P)$ where M=10 bit R= 8 bit P= 5 bit $CLK[0:2] = F_{out} / (1,2,4,8), F_{REF}$ OR $F_{REF} / 2$ | Std: 10mA (default) High: 24mA | +/- 200ppm tuning. | One output pin can be configured as 1. CLK2 - output 2. FSEL - input 3. OE - input 4. PDB - input | 4 levels of pump current settings |

PIN DESCRIPTION

| Name | Pin # | | Type | Description | | | | | | | | | | | | |
|---------------------|-------------------|-----------------|------------------|---|-------|----|-----|------|---|-------------------|-----------------|------------------|-------------|-------------|-------------|------------------|
| | MSOP-8 SOIC-8 | SOT-23 | | | | | | | | | | | | | | |
| XIN, FIN | 1 | 3 | I | Crystal or Reference input pin | | | | | | | | | | | | |
| GND | 2 | 2 | P | GND connection | | | | | | | | | | | | |
| CLK[0:1] | 3,4 | 1 | O | Programmable Clock Output | | | | | | | | | | | | |
| VDD | 5 | 6 | P | VDD connection (2.25~3.63V) | | | | | | | | | | | | |
| NC | 6 | | | No Connect | | | | | | | | | | | | |
| CLK2, OE, PDB, FSEL | 7 | 5 | B | This programmable I/O pin can be configured as a programmable clock output (CLK2), or Output Enable (OE) input, or Power Down input (PDB), or Frequency Selection (FSEL) input pin. This pin has an internal 60KΩ pull up resistor. <table border="1" data-bbox="852 1381 1481 1556"> <thead> <tr> <th>State</th> <th>OE</th> <th>PDB</th> <th>FSEL</th> </tr> </thead> <tbody> <tr> <td>0</td> <td>Tristate CLK[0:1]</td> <td>Power Down Mode</td> <td>Select Freq. '1'</td> </tr> <tr> <td>1 (default)</td> <td>Normal mode</td> <td>Normal mode</td> <td>Select Freq. '2'</td> </tr> </tbody> </table> | State | OE | PDB | FSEL | 0 | Tristate CLK[0:1] | Power Down Mode | Select Freq. '1' | 1 (default) | Normal mode | Normal mode | Select Freq. '2' |
| State | OE | PDB | FSEL | | | | | | | | | | | | | |
| 0 | Tristate CLK[0:1] | Power Down Mode | Select Freq. '1' | | | | | | | | | | | | | |
| 1 (default) | Normal mode | Normal mode | Select Freq. '2' | | | | | | | | | | | | | |
| XOUT | 8 | 4 | O | Crystal output pin | | | | | | | | | | | | |

ELECTRICAL SPECIFICATIONS
ABSOLUTE MAXIMUM RATINGS

| PARAMETERS | SYMBOL | MIN. | MAX. | UNITS |
|---------------------------------------|----------|------|--------------|-------|
| Supply Voltage Range | V_{DD} | -0.5 | 4.6 | V |
| Input Voltage Range | V_i | -0.5 | $V_{DD}+0.5$ | V |
| Output Voltage Range | V_o | -0.5 | $V_{DD}+0.5$ | V |
| Soldering Temperature (Green package) | | | 260 | °C |
| Storage Temperature | T_s | -65 | 150 | °C |
| Ambient Operating Temperature | | -40 | 85 | °C |

Exposure of the device under conditions beyond the limits specified by Maximum Ratings for extended periods may cause permanent damage to the device and affect product reliability. These conditions represent a stress rating only, and functional operations of the device at these or any other conditions above the operational limits noted in this specification is not implied. *Operating temperature is guaranteed by design. Parts are tested to commercial grade only.

AC SPECIFICATIONS

| PARAMETERS | CONDITIONS | MIN. | TYP. | MAX. | UNITS |
|--|---|------|------|----------|---------------|
| Crystal Input Frequency(XIN) | Fundamental Crystal | 10 | | 30 | MHz |
| | 3 rd Overtone Crystal | | | 75 | MHz |
| Input (FIN) Frequency | | | | 200 | MHz |
| Input (FIN) Signal Amplitude | Internally AC coupled | 0.9 | | V_{DD} | Vpp |
| Settling Time | At power-up (after V_{DD} increases over 2.25V) | | | 2 | ms |
| Output Enable Time | OE Function; $T_a=25^\circ\text{C}$, 15pF Load | | | 100 | μs |
| | PDB Function; $T_a=25^\circ\text{C}$, 15pF Load | | | 2 | ms |
| PLL Settling Time | After Crystal Start Up (Crystal Input) | | | 100 | μs |
| | After Reference Input Present (FIN) | | | 100 | μs |
| Output Rise Time | 15pF Load, 10/90% V_{DD} , Standard drive | | 2.5 | 3.5 | ns |
| | 15pF Load, 10/90% V_{DD} , High drive | | 1.0 | 1.5 | ns |
| Output Fall Time | 15pF Load, 90/10% V_{DD} , Standard drive | | 2.5 | 3.5 | ns |
| | 15pF Load, 90/10% V_{DD} , High drive | | 1.0 | 1.5 | ns |
| Duty Cycle | At $V_{DD}/2$ | 45 | 50 | 55 | % |
| Max. output skew between same frequency clocks | Equal loading (15 pF). Equal frequency & drive strength | | | 500 | ps |
| Period Jitter, peak-to-peak* (10,000 samples measured) | With capacitive decoupling between V_{DD} and GND. Operating only one output. | | 70 | | ps |

* Note: Jitter performance depends on the programming parameters.

DC SPECIFICATIONS

| PARAMETERS | SYMBOL | CONDITIONS | MIN. | TYP. | MAX. | UNITS |
|--|------------------|--|-----------------------|------|------|-------|
| Supply Current, Dynamic, with Loaded Outputs | I _{DD} | At 10MHz, load=15pF (PDB=1) | | | 15 | mA |
| | | PDB=0 | | | 5 | μA |
| Operating Voltage | V _{DD} | | 2.25 | | 3.63 | V |
| Output Low Voltage | V _{OL} | I _{OL} = +4mA Standard drive | | | 0.4 | V |
| Output High Voltage | V _{OH} | I _{OH} = -4mA Standard drive | V _{DD} - 0.4 | | | V |
| Output Current, Standard drive | I _{OSD} | V _{OL} = 0.4V, V _{OH} = 2.4V | | | 10 | mA |
| Output Current, High drive | I _{OHD} | V _{OL} = 0.4V, V _{OH} = 2.4V | | | 24 | mA |
| Short-circuit Current | I _S | | | ±50 | | mA |

CRYSTAL SPECIFICATIONS

| PARAMETERS | SYMBOL | MIN. | TYP. | MAX. | UNITS |
|--|-----------------------|------|------|--------|-------|
| Fundamental Crystal Resonator Frequency | F _{XIN} | 10 | | 30 | MHz |
| 3 rd Overtone Crystal Resonator Frequency | F _{XIN} | | | 75 | MHz |
| Crystal Loading Rating (The IC can be programmed for any value in this range.) | C _{L (xtal)} | 5 | | 20 | pF |
| Maximum Sustainable Drive Level | | | | 500 | μW |
| Operating Drive Level | | | 100 | | μW |
| Crystal Shunt Capacitance | C ₀ | | | 6 | pF |
| Effective Series Resistance, Fundamental, 10-30MHz | ESR | | | 30 | Ω |
| Effective Series Resistance, 3 rd Overtone, 30-50MHz [C ₀ < 4pF, C _L =(5pF)/(8pF)] | ESR | | | 100/70 | Ω |
| Effective Series Resistance, 3 rd Overtone, 50-65MHz, [C ₀ < 4pF, C _L =5pF(5pF)/(8pF)] | ESR | | | 60/40 | Ω |
| Effective Series Resistance, 3 rd Overtone, 65-75MHz [C ₀ < 4pF, C _L =(5pF)/(8pF)] | ESR | | | 45/30 | Ω |

PACKAGE DRAWINGS (GREEN PACKAGE COMPLIANT)

MSOP-8L

| Symbol | Dimension in MM | |
|--------|-----------------|-------|
| | Min. | Max. |
| A | --- | 1.10 |
| A1 | 0.05 | 0.15 |
| A2 | 0.81 | 0.91 |
| B | 0.25 | 0.40 |
| C | 0.13 | 0.23 |
| D | 2.90 | 3.10 |
| E | 2.90 | 3.10 |
| H | 4.90 BSC | |
| L | 0.445 | 0.648 |
| e | 0.65 BSC | |

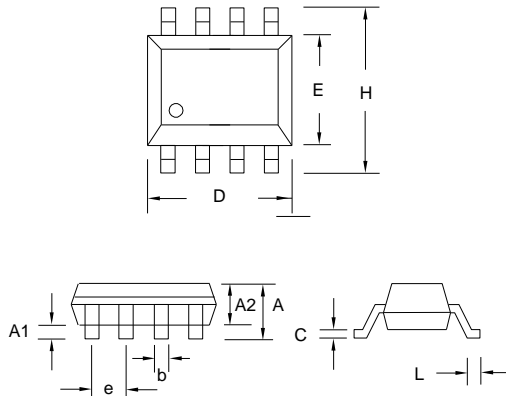

SOP-8L

| Symbol | Dimension in MM | |
|--------|-----------------|------|
| | Min. | Max. |
| A | 1.35 | 1.75 |
| A1 | 0.10 | 0.25 |
| A2 | 1.25 | 1.50 |
| B | 0.33 | 0.53 |
| C | 0.19 | 0.27 |
| D | 4.80 | 5.00 |
| E | 3.80 | 4.00 |
| H | 5.80 | 6.20 |
| L | 0.40 | 0.89 |
| e | 1.27 BSC | |

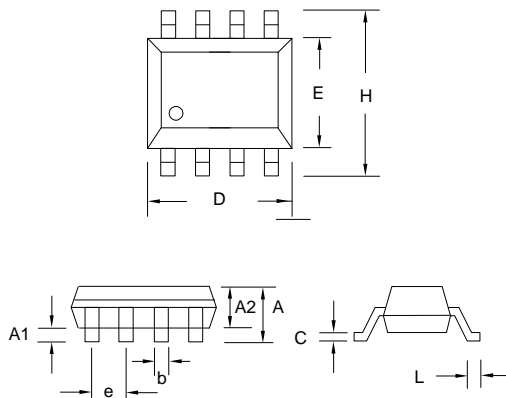

SOT23-6 L

| Symbol | Dimension in MM | |
|--------|-----------------|------|
| | Min. | Max. |
| A | 1.05 | 1.45 |
| A1 | 0.05 | 0.15 |
| A2 | 0.90 | 1.30 |
| b | 0.30 | 0.50 |
| C | 0.08 | 0.22 |
| D | 2.80 BSC | |
| E | 1.60 BSC | |
| H | 2.80 BSC | |
| L | 0.30 | 0.60 |
| e | 0.95 BSC | |

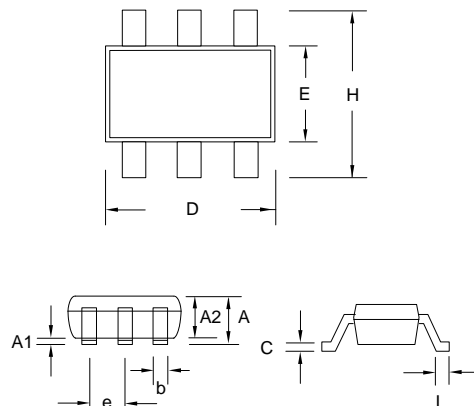

ORDERING INFORMATION (GREEN PACKAGE COMPLIANT)

For part ordering, please contact our Sales Department:

2180 Fortune Drive, San Jose, CA 95131, USA
 Tel: (408) 944-0800 Fax: (408) 474-1000

PART NUMBER

The order number for this device is a combination of the following:
 Part number, Package type and Operating temperature range

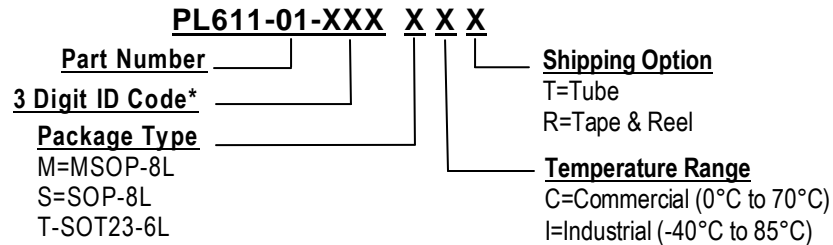

* Micrel will assign a unique 3-digit ID code for each approved programmed part number.

| Part / Order Number | Marking | Part / Order Number | Marking | Package Option |
|---------------------|----------------|---------------------|-----------------|------------------------------|
| PL611-01-XXXMC | C1XXX | PL611-01-XXXMI | C1XXX | 8-Pin MSOP (Tube) |
| PL611-01-XXXMC-R | LLL | PL611-01-XXXMI-R | LLLI | 8-Pin MSOP (Tape and Reel) |
| PL611-01-XXXSC | P611-01 XXX | PL611-01-XXXSI | P611-01 XXXI | 8-Pin SOP (Tube) |
| PL611-01-XXXSC-R | LLLLL | PL611-01-XXXSI-R | LLLLL | 8-Pin SOP (Tape and Reel) |
| PL611-01-XXXTC | C1XXX | PL611-01-XXXTI | C1XXX | 6-Pin SOT-23 (Tape) |
| PL611-01-XXXTC-R | LLL | PL611-01-XXXTI-R | LLLI | 6-Pin SOT-23 (Tape and Reel) |

† Note: 'XXX' designates marking identifier that, at times, could be independent of the part number.
 "LLL" and "LLLLL" means assembly from which lot number.

Micrel Inc., reserves the right to make changes in its products or specifications, or both at any time without notice. The information furnished by Micrel is believed to be accurate and reliable. However, Micrel makes no guarantee or warranty concerning the accuracy of said information and shall not be responsible for any loss or damage of whatever nature resulting from the use of, or reliance upon this product.

LIFE SUPPORT POLICY: Micrel's products are not authorized for use as critical components in life support devices or systems without the express written approval of the President of Micrel Inc.



Компания «ЭлектроПласт» предлагает заключение долгосрочных отношений при поставках импортных электронных компонентов на взаимовыгодных условиях!

Наши преимущества:

- Оперативные поставки широкого спектра электронных компонентов отечественного и импортного производства напрямую от производителей и с крупнейших мировых складов;
- Поставка более 17-ти миллионов наименований электронных компонентов;
- Поставка сложных, дефицитных, либо снятых с производства позиций;
- Оперативные сроки поставки под заказ (от 5 рабочих дней);
- Экспресс доставка в любую точку России;
- Техническая поддержка проекта, помощь в подборе аналогов, поставка прототипов;
- Система менеджмента качества сертифицирована по Международному стандарту ISO 9001;
- Лицензия ФСБ на осуществление работ с использованием сведений, составляющих государственную тайну;
- Поставка специализированных компонентов (Xilinx, Altera, Analog Devices, Intersil, Interpoint, Microsemi, Aeroflex, Peregrine, Syfer, Eurofarad, Texas Instrument, Miteq, Cobham, E2V, MA-COM, Hittite, Mini-Circuits, General Dynamics и др.);

Помимо этого, одним из направлений компании «ЭлектроПласт» является направление «Источники питания». Мы предлагаем Вам помощь Конструкторского отдела:

- Подбор оптимального решения, техническое обоснование при выборе компонента;
- Подбор аналогов;
- Консультации по применению компонента;
- Поставка образцов и прототипов;
- Техническая поддержка проекта;
- Защита от снятия компонента с производства.



Как с нами связаться

Телефон: 8 (812) 309 58 32 (многоканальный)

Факс: 8 (812) 320-02-42

Электронная почта: org@eplast1.ru

Адрес: 198099, г. Санкт-Петербург, ул. Калинина, дом 2, корпус 4, литера А.