

# E Series Sealed Miniature Rocker and Lever Handle Switches

## Features/Benefits

- Sealed against solder and cleaning process contaminants
- ESD Resistance—all actuator options
- Rocker, case & bushing UL 94V-0
- RoHS compliant

## Typical Applications

- Telecommunications
- Instrumentation
- Computers & peripherals

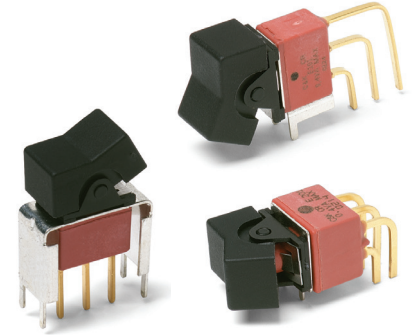

## Specifications

**CONTACT RATING:** B contact material: 0.4 VA max. @ 20 V AC or DC max. Q contact material (E1XX & E2XX Models): 7.5 AMPS @ 125 V AC or 28 V DC; 3 AMPS @ 250 V AC. (E3XX Models): 5 AMPS @ 125 V AC or 28 V DC; 2 AMPS @ 250 V AC. See page G-36 for additional ratings.

**ELECTRICAL LIFE:** E1XX and E2XX models: 40,000 make-and-break cycles at full load. E3XX models: 30,000 cycles.

**CONTACT RESISTANCE:** Below 10 m Ω typ. initial @ 2-4 V DC, 100 mA, for both silver and gold plated contacts.

**INSULATION RESISTANCE:** 10<sup>9</sup> Ω min.

**ELECTROSTATIC DISCHARGE (ESD) OPTION:** All actuator options: 15,000 V DC max. @ sea level, actuator to terminals.

**DIELECTRIC STRENGTH:** 1000 Vrms min. @ sea level.

**OPERATING TEMPERATURE:** -30°C to 85°C.

**SOLDERABILITY:** Per MIL-STD-202F method 208D, or EIA RS-186E method 9 (1 hour steam aging).

## Materials

**CASE & BUSHING:** Glass filled nylon 6/6, flame retardant, heat stabilized (UL 94V-0).

**ACTUATOR:** Nylon, black standard, internal o-ring seal standard with all actuators.

**FRAME:** Spring steel, black standard.

**SWITCH SUPPORT:** Brass or steel, matte-tin plated.

**ACTUATOR PIVOT & MOUNTING BRACKET:** Nylon.

**ACTUATOR PIVOT RETAINER:** Stainless steel.

**CONTACTS & TERMINALS:** B contact material: Copper alloy, with gold plate over nickel plate. Q contact material: Copper alloy, silver plated. See page G-36 for additional contact materials.

**TERMINAL SEAL:** Epoxy.

**HARDWARE:** Nut, Screw & Lockwasher: Stainless steel. Standoff: Nylon standard, aluminum available, consult Customer Service Center.

**NOTE:** Any models supplied with Q, B, G, S, P & R contact material are RoHS compliant.

**NOTE:** Specifications and materials listed above are for switches with standard options. For information on specific and custom switches, consult Customer Service Center.

## Build-A-Switch

To order, simply select desired option from each category and place in the appropriate box. Available options are shown and described on pages G-26 through G-38. For additional options not shown in catalog, consult Customer Service Center. All models are process sealed to withstand machine soldering temperatures and pressure wash cleaning methods.

<p><b>Switch Function</b></p> <p><b>E101</b> SP On-None-On  <b>E103</b> SP On-Off-On  <b>E105</b> SP Mom.-Off-Mom.  <b>E107</b> SP On-Off-Mom.  <b>E108</b> SP On-None-Mom.  <b>E201</b> DP On-None-On  <b>E203</b> DP On-Off-On  <b>E205</b> DP Mom.-Off-Mom.  <b>E207</b> DP On-Off-Mom.  <b>E208</b> DP On-None-Mom.  <b>E211</b> DP On-On-On  <b>E213</b> DP On-On-Mom.  <b>E215</b> DP Mom.-On-Mom.  <b>E301</b> 3P On-None-On</p>	<p><b>Actuator</b></p> <p><b>J1</b> .531" long rocker  <b>J2</b> Lever  <b>J3</b> .906" long rocker  <b>J11</b> Rocker with frame  <b>J21</b> Lever with frame  <b>J50</b> .362" long rocker  <b>J60</b> Lever  <b>J90</b> Lever</p>	<p><b>Terminations</b></p> <p><b>A</b> Right angle, PC thru-hole  <b>AV2</b> Vertical right angle, PC thru-hole  <b>C</b> PC Thru-hole  <b>Z</b> Solder lug  <b>A3</b> Right angle, snap-in, PC thru-hole  <b>AV3</b> Vertical right angle, snap-in, PC thru-hole  <b>V3</b> .460" high, V-bracket  <b>V4</b> .630" high, V-bracket  <b>V5</b> Vertical right angle, PC thru-hole  <b>V6</b> .460" high, V-bracket  <b>V7</b> .630" high, V-bracket  <b>V8</b> .953" high, V-bracket  <b>V21</b> .555" high, V-bracket, snap-in  <b>V31</b> .460" high, V-bracket, snap-in</p>	<p><b>Contact Material</b></p> <p><b>B</b> Gold  <b>P</b> Gold, matte tin  <b>Q</b> Silver  <b>S</b> Silver, matte-tin  <b>G</b> Gold over silver  <b>R</b> Gold over silver, matte-tin</p> <p><b>Seal</b></p> <p><b>E</b> Epoxy</p> <p><b>Actuator Color</b></p> <p><b>2</b> Black  <b>3</b> Red</p> <p><b>Frame Color</b></p> <p><b>2</b> Black  <b>NONE</b> No frame color required</p> <p><b>Metal Frame Color</b>          (J11, J21 Actuators)  <b>2</b> Black</p>
---	--	--	--

Rocker



G



Dimensions are shown: Inches (mm)  
 Specifications and dimensions subject to change

# E Series Sealed Miniature Rocker and Lever Handle Switches

## SWITCH FUNCTION



NO. POLES	MODEL NO.	SWITCH FUNCTION			CONNECTED TERMINALS			SCHEMATIC
		POS. 1	POS. 2	POS. 3	POS. 1	POS. 2	POS. 3	
		C&K marking on opposite side			C&K marking on opposite side			
SP	<b>E101</b>	ON	NONE	ON	2-3	N/A	2-1	
	<b>E103</b>	ON	OFF	ON				
	<b>E105</b>	MOM.	OFF	MOM.				
	<b>E107</b>	ON	OFF	MOM.				
	<b>E108</b>	ON	NONE	MOM.				
							SPDT	

### SPDT

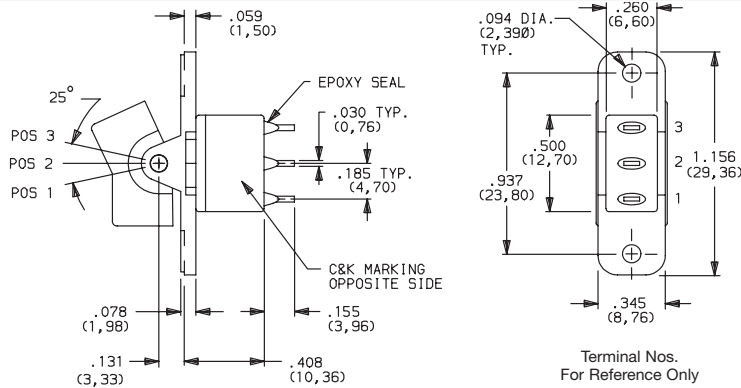

Part number shown: E101J1ZBE2

Terminal Nos.  
For Reference Only

DP	<b>E201</b>	ON	NONE	ON	2-3,5-6	N/A	2-1,5-4	
	<b>E203</b>	ON	OFF	ON				
	<b>E205</b>	MOM.	OFF	MOM.				
	<b>E207</b>	ON	OFF	MOM.				
	<b>E208</b>	ON	NONE	MOM.				
	<b>E211**</b>	ON	ON	ON				
	<b>E213**</b>	ON	ON	MOM.				
	<b>E215**</b>	MOM.	ON	MOM.				
							DPDT	

### DPDT

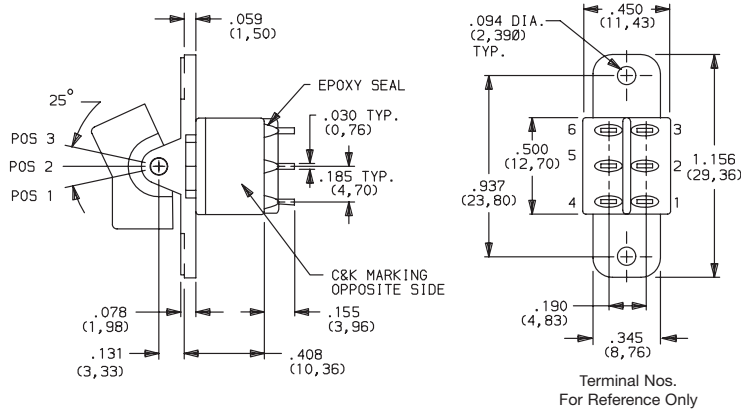

Part number shown: E201J1ZBE2

Terminal Nos.  
For Reference Only

MOM. = Momentary

\*\* Wiring for 3-way switch, Hardware available separately, see Technical Data section of this catalog.

All models with all options when ordered with G, Q, R or S contact material.

Rocker

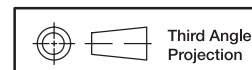

Third Angle  
Projection

Dimensions are shown: Inches (mm)  
Specifications and dimensions subject to change



# E Series

## Sealed Miniature Rocker and Lever Handle Switches

### SWITCH FUNCTION

NO. POLES	MODEL NO.	SWITCH FUNCTION			CONNECTED TERMINALS			SCHEMATIC
		POS. 1	POS. 2	POS. 3	POS. 1	POS. 2	POS. 3	
		C&K marking on opposite side			C&K marking on opposite side			
3P	<b>E301</b>	ON	NONE	ON	2-3-5-6-8-9	N/A	2-1-5-4-8-7	<p style="text-align: center;">3PDT</p>
<b>3PDT</b>								
Part number shown: E301J1ZBE2								

MOM. = Momentary

\*\* Wiring for 3-way switch, see Technical Data section of this catalog.

All models with all options when ordered with G, Q, R and S contact material.

### ACTUATOR-PANEL REAR MOUNT

OPTION CODE	ACTUATOR COLOR
<b>2</b>	<b>BLACK</b>
<b>3</b>	<b>RED</b>

Finish: Matte. Other colors, custom actuator markings and legends available, consult Customer Service Center.

**NOTE:** Hardware: two each—mounting screws, nuts, lockwashers and standoffs for 1/8 inch thick panel are supplied standard on switches with panel mounting bracket. Internal o-ring actuator seal standard. Actuators available separately, see page G-36. Hardware available separately, see Technical Data section of this catalog. J1, J2 actuators available with C, Z or Z3 terminations.

#### J1 LEVER

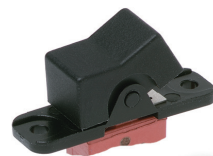
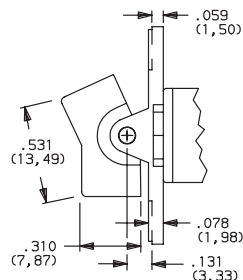
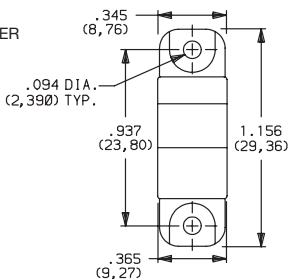

#### J2 LEVER

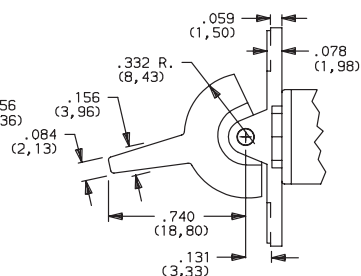
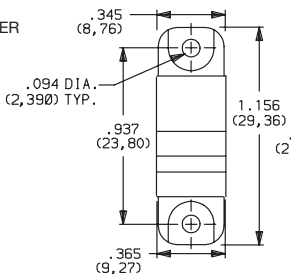

#### PANEL MOUNTING

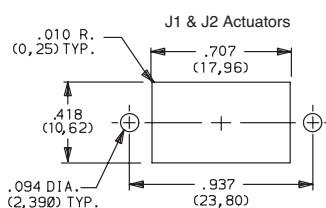

Dimensions are shown: Inches (mm)

Specifications and dimensions subject to change

Rocker



# E Series Sealed Miniature Rocker and Lever Handle Switches

## ACTUATOR-REAR MOUNT

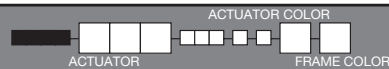

### J11 ROCKER WITH FRAME

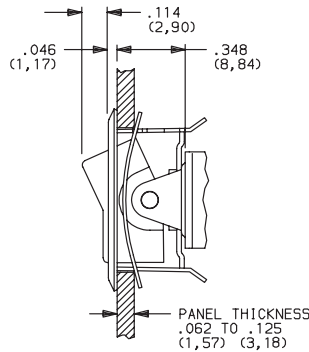
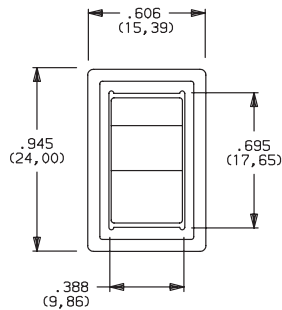

OPTION CODE	ACTUATOR COLOR
2	BLACK
3	RED

OPTION CODE	FRAME COLOR
2	BLACK

NOTE: This option has reduced anti-static capability.

### J21 LEVER WITH FRAME

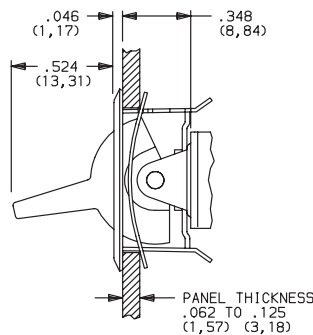
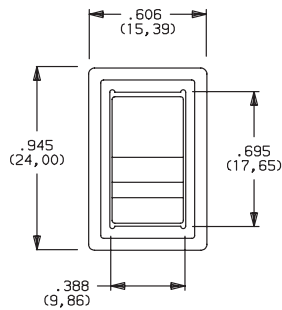

Actuator finish: Matte, frame finish: gloss. Other colors, custom actuator markings and legends available, consult Customer Service Center.

NOTE: Internal o-ring actuator seal standard. Actuators & frames available separately, see page G-36. Hardware available separately, see Technical Data section of this catalog. N, J11 & J21 actuators available with C, Z & Z3 terminations.

NOTE: This option has reduced anti-static capability.

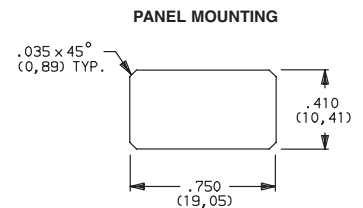

## ACTUATOR-PC MOUNT

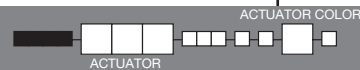

### J1 ROCKER

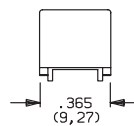
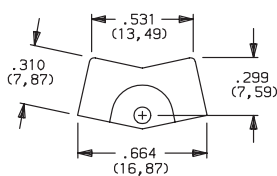
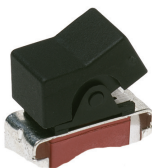

OPTION CODE	ACTUATOR COLOR
2	BLACK
3	RED

### J2 LEVER

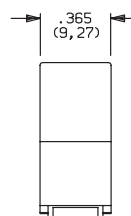
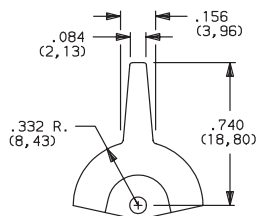

Finish: Matte. Other colors, custom actuator markings and legends available, consult Customer Service Center.

NOTE: Hardware: two each—mounting screws, nuts, lockwashers and standoffs for 1/8 inch thick panel are supplied standard on switches with panel mounting bracket. Internal o-ring actuator seal standard. Actuators available separately, see page G-36. Hardware available separately, see Technical Data section of this catalog. J1, J2 actuators available with A, A3, AV2, AV3, V2-V61 terminations.



Third Angle Projection

Dimensions are shown: Inches (mm)  
Specifications and dimensions subject to change



# E Series Sealed Miniature Rocker and Lever Handle Switches

## ACTUATOR-PC MOUNT

ACTUATOR COLOR

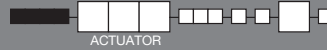

OPTION CODE	ACTUATOR COLOR
2	BLACK
3	RED

Finish: Matte. Other colors, custom actuator markings and legends available, consult Customer Service Center.

**NOTE:** Hardware: two each—mounting screws, nuts, lockwashers and standoffs for 1/8 inch thick panel are supplied standard on switches with panel mounting bracket. Internal o-ring actuator seal standard. Actuators available separately, see page G-36. Hardware available separately, see Technical Data section of this catalog.

J3 actuators available with AV2, AV3 & V2-V61 terminations. Some permissible actuator/termination combinations may lack clearance between actuator and PC board, and care must be exercised to accommodate this condition.

J50, J60 & J90 actuators available with A, AV2, AV3, V2 – V61 terminations.

### J3 ROCKER

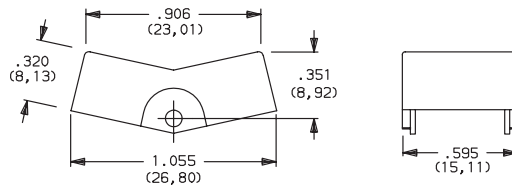

### J50 ROCKER

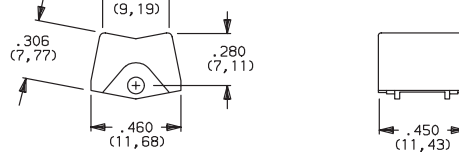

### J60 LEVER

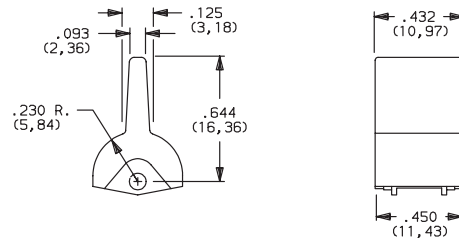

### J90 LEVER

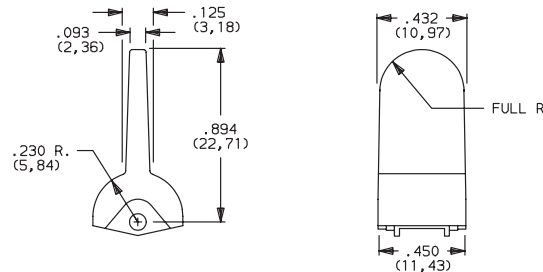

## TERMINATIONS

### Z SOLDER LUG

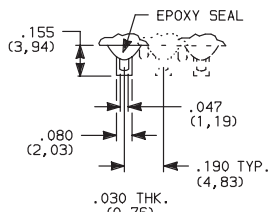

### SPDT thru 3PDT

Not available with P, S, & R contact materials. Available actuators, see page G-27-28.

### C PC THRU-HOLE

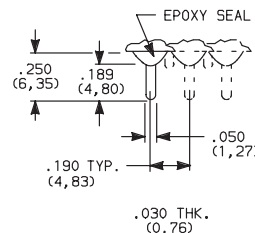

### SPDT thru 3PDT

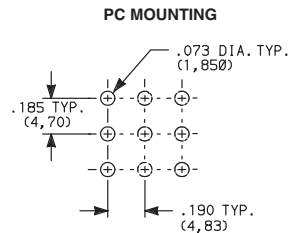

Dimensions are shown: Inches (mm)  
Specifications and dimensions subject to change

Rocker

G



# E Series Sealed Miniature Rocker and Lever Handle Switches

## TERMINATIONS

### Z3 QUICK CONNECT

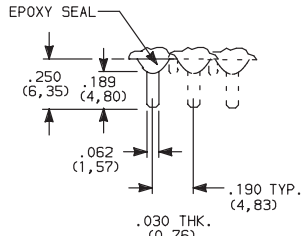

Not available with P, S, & R contact materials. Available actuators, see pages G-27 thru G-28. Mating quick connector available; order part number 530100000, page G-37.

### SPDT thru 3PDT

#### A RIGHT ANGLE, PC THRU-HOLE

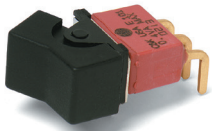

**E101J1ABE2**  
Horizontal Actuation  
**SPDT**

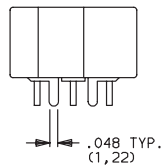

Actuator Shown In Pos. 1

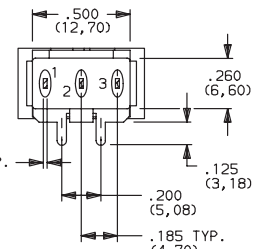
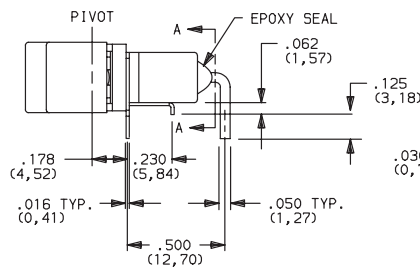

SECTION A-A

#### A3 RIGHT ANGLE, SNAP-IN, PC THRU-HOLE

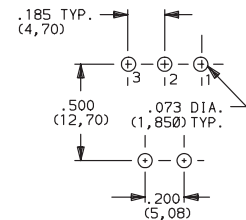
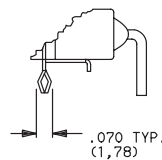
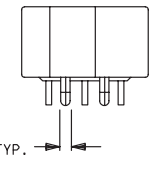

PC MOUNTING

**NOTE:** Not available with J3, J50, J60 and J90 actuators. Available actuators, see pages G-27 thru G-29. Terminal bend radii and lead-in manufacturing option.

**NOTE:** PC mounting pattern must clear switch support leg.

#### A RIGHT ANGLE, PC THRU-HOLE

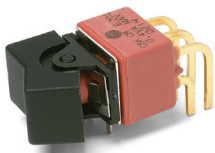

**E201J1ABE2**  
Horizontal Actuation  
**DPDT**

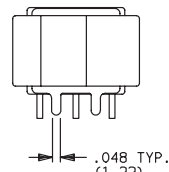

Actuator Shown In Pos. 1

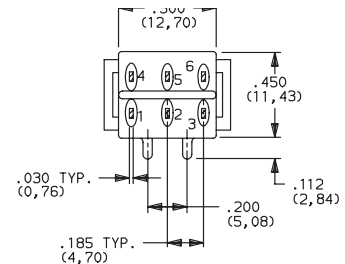
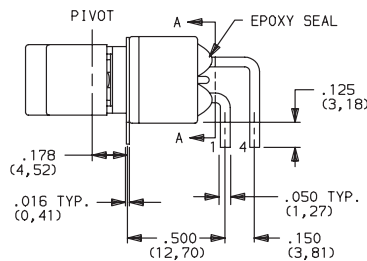

SECTION A-A

#### A3 RIGHT ANGLE, SNAP-IN, PC THRU-HOLE

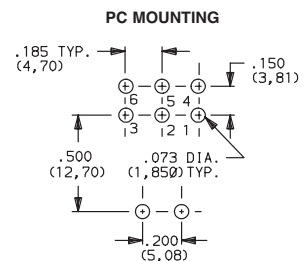
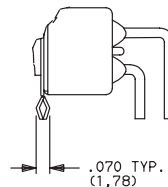
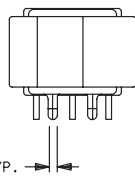

PC MOUNTING

**NOTE:** Not available with J3 actuator. Available actuators, see pages G-27 thru G-29. Terminal bend radii and lead-in manufacturing option.

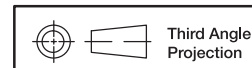

Third Angle Projection

Dimensions are shown: Inches (mm)  
Specifications and dimensions subject to change



# E Series Sealed Miniature Rocker and Lever Handle Switches

## TERMINATIONS

### A RIGHT ANGLE, PC THRU-HOLE

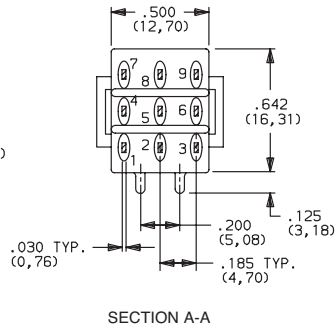
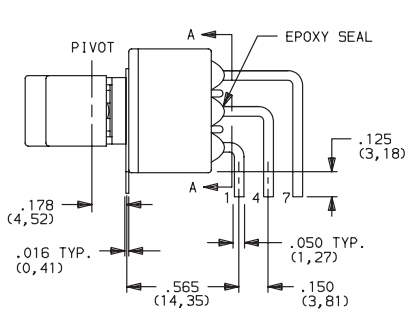
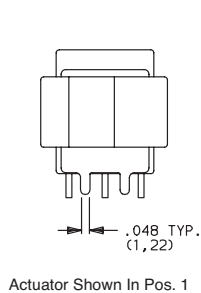

E301J1ABE2  
Horizontal Actuation  
3PDT

### PC MOUNTING

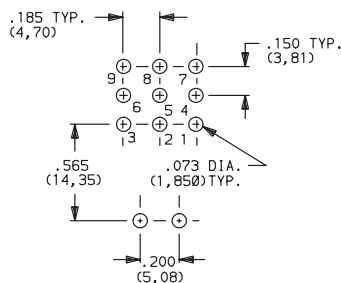

**NOTE:** Terminal bend radii and lead-in manufacturing option. Available actuators, see pages G-27 thru G-29.

### AV2 VERTICAL RIGHT ANGLE, PC THRU-HOLE, .150" PITCH

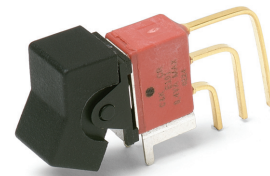
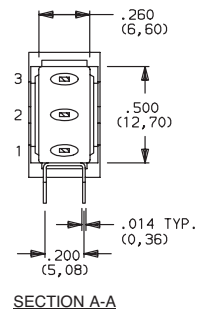
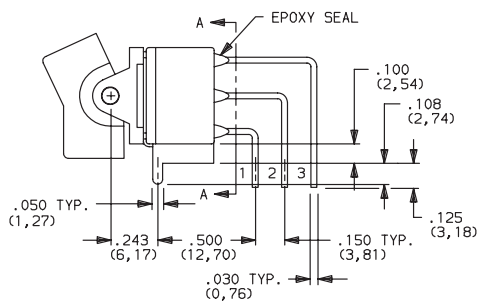
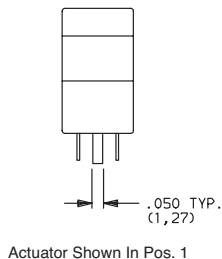

E101J1AV2BE2  
Vertical Actuation  
SPDT

### AV3 VERTICAL RIGHT ANGLE, SNAP-IN, PC THRU-HOLE, .150" PITCH

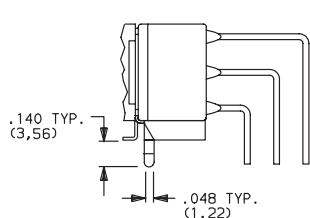
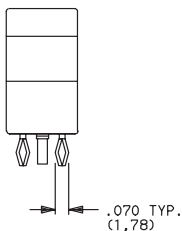

### PC MOUNTING

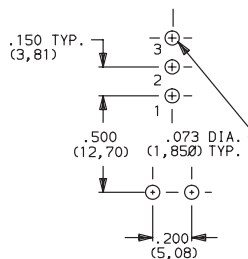

**NOTE:** Terminal bend radii and lead-in manufacturing option. Available actuators, see pages G-27 thru G-29.

Rocker

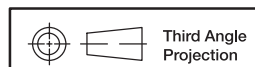

Dimensions are shown: Inches (mm)  
Specifications and dimensions subject to change

# E Series Sealed Miniature Rocker and Lever Handle Switches

## TERMINATIONS



**AV2** VERTICAL RIGHT ANGLE, PC THRU-HOLE,  
.150" PITCH

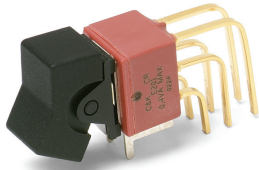

**E201J1AV2BE2**  
Vertical Actuation  
**DPDT**

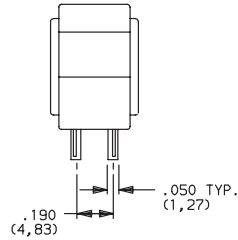

Actuator Shown In Pos. 1

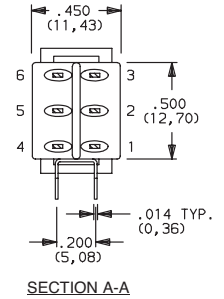
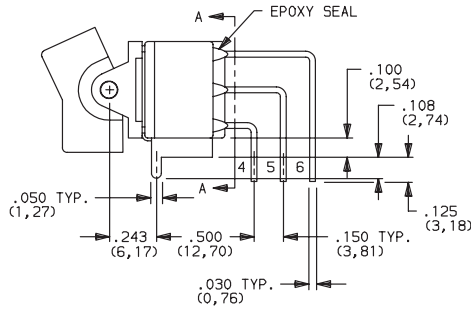

**AV3** VERTICAL RIGHT ANGLE, SNAP-IN, PC THRU-HOLE,  
.150" PITCH

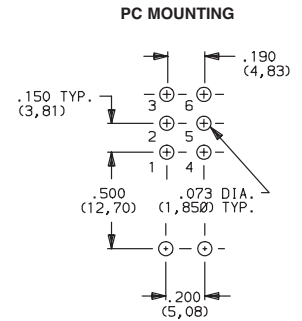
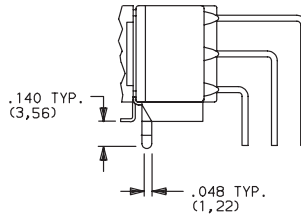
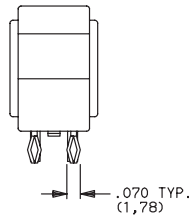

**NOTE:** Terminal bend radii and lead-in manufacturing option.  
Available actuators, see pages G-27 thru G-29.

**AV2** VERTICAL RIGHT ANGLE, PC THRU-HOLE,  
.150" PITCH

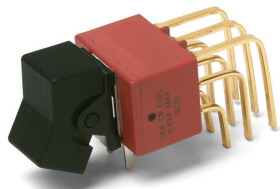

**E301J1AV2BE2**  
Vertical Actuation  
**3PDT**

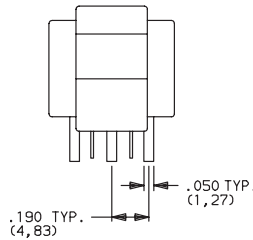

Actuator Shown In Pos. 1

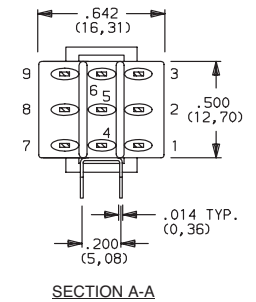
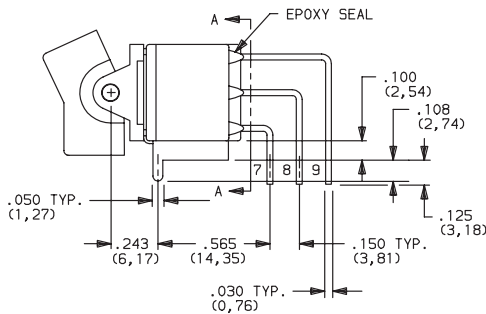

**AV3** VERTICAL RIGHT ANGLE, SNAP-IN, PC THRU-HOLE,  
.150" PITCH

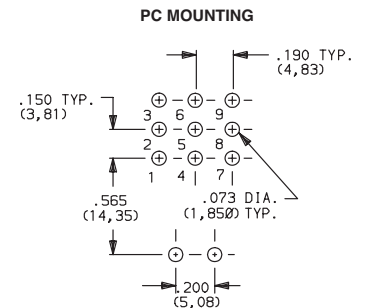
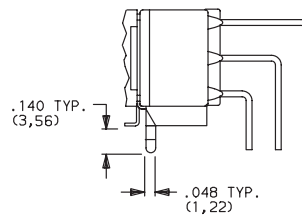
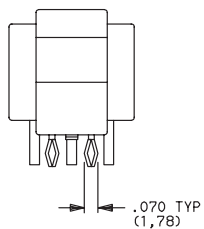

**NOTE:** Terminal bend radii and lead-in manufacturing option.  
Available actuators, see pages G-27 thru G-29.

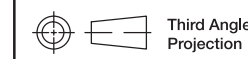

Third Angle  
Projection

Dimensions are shown: Inches (mm)  
Specifications and dimensions subject to change





# E Series Sealed Miniature Rocker and Lever Handle Switches

## TERMINATIONS

**V5** VERTICAL RIGHT ANGLE, PC THRU-HOLE,  
.150" PITCH

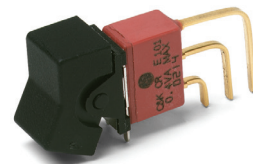
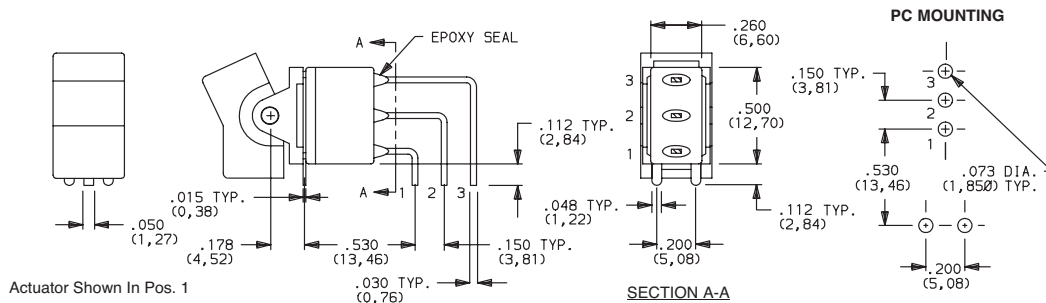

E101J1V5BE2  
Vertical Actuation  
SPDT

**NOTE:** Terminal bend radii and lead-in manufacturing option.  
Available actuators, see pages G-27 thru G-29.

**V5** VERTICAL RIGHT ANGLE, PC THRU-HOLE,  
.150" PITCH

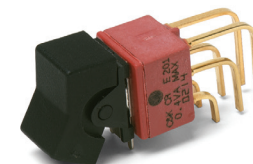
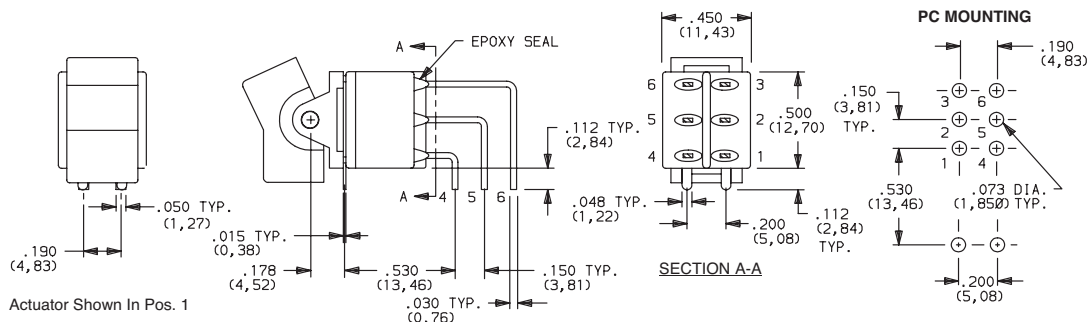

E201J1V5BE2  
Vertical Actuation  
DPDT

**NOTE:** Terminal bend radii and lead-in manufacturing option.  
Available actuators, see pages G-27 thru G-29.

# E Series Sealed Miniature Rocker and Lever Handle Switches

## TERMINATIONS



**V6, V7, V8** VERTICAL MOUNT, V-BRACKET

**V21** VERTICAL MOUNT, V-BRACKET, SNAP-IN

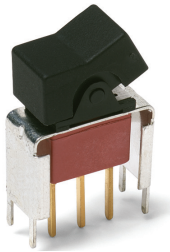

**E101J1\_BE2**  
**SPDT**

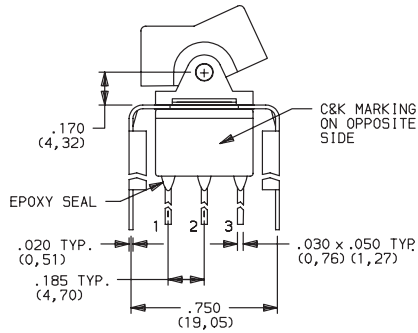

Actuator Shown In Pos. 1

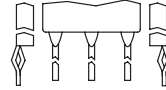

SNAP-IN

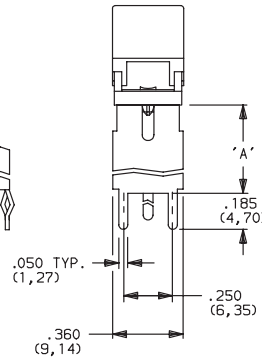

### PC MOUNTING

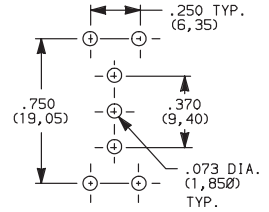

OPTION CODE	DIM 'A'
<b>V21</b>	.555 (14, 10)
<b>V6</b>	.460 (11, 68)
<b>V7</b>	.630 (16, 00)
<b>V8</b>	.953 (24, 21)

**NOTE:** Available actuators, see pages G-27 thru G-29.

**V6, V7, V8** VERTICAL MOUNT, V-BRACKET

**V21** VERTICAL MOUNT, V-BRACKET, SNAP-IN

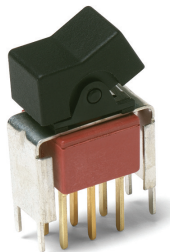

**E201J1\_BE2**  
**DPDT**

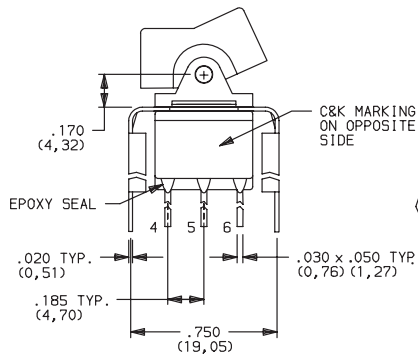

Actuator Shown In Pos. 1

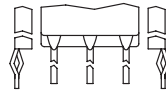

SNAP-IN

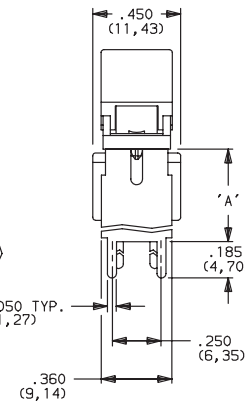

### PC MOUNTING

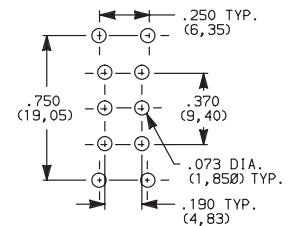

OPTION CODE	DIM 'A'
<b>V21</b>	.555 (14, 10)
<b>V6</b>	.460 (11, 68)
<b>V7</b>	.630 (16, 00)
<b>V8</b>	.953 (24, 21)

**NOTE:** Available actuators, see pages G-27 thru G-29.

**V7, V8** VERTICAL MOUNT, V-BRACKET

**V21** VERTICAL MOUNT, V-BRACKET, SNAP-IN

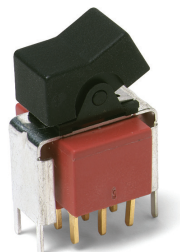

**E301J1\_BE2**  
**3PDT**

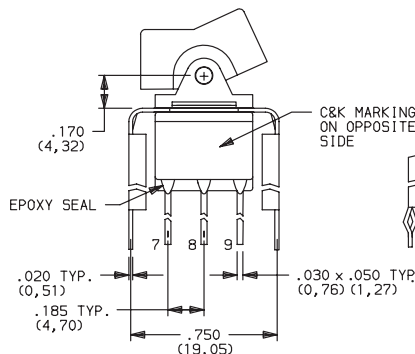

Actuator Shown In Pos. 1

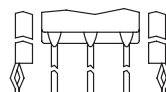

SNAP-IN

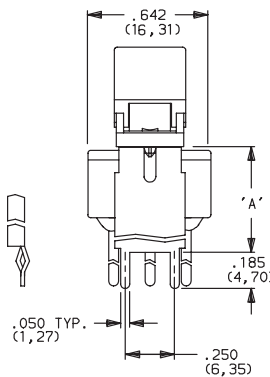

### PC MOUNTING

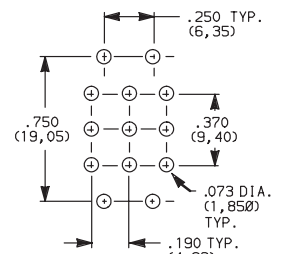

OPTION CODE	DIM 'A'
<b>V21</b>	.555 (14, 10)
<b>V7</b>	.630 (16, 00)
<b>V8</b>	.953 (24, 21)

**NOTE:** Available actuators, see pages G-27 thru G-29.

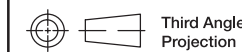

Third Angle Projection

Dimensions are shown: Inches (mm)  
Specifications and dimensions subject to change



# E Series Sealed Miniature Rocker and Lever Handle Switches

## TERMINATIONS

**V3, V4** VERTICAL MOUNT, V-BRACKET

**V31** VERTICAL MOUNT, V-BRACKET, SNAP-IN

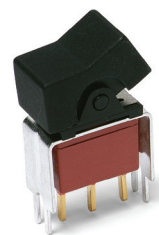

**E101J1\_BE2**  
**SPDT**

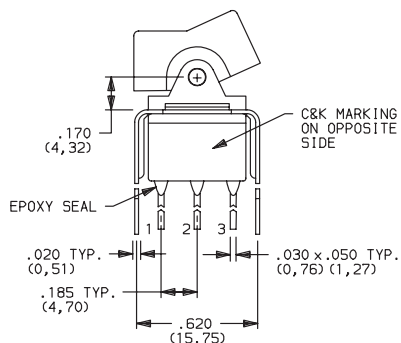

Actuator Shown In Pos. 1

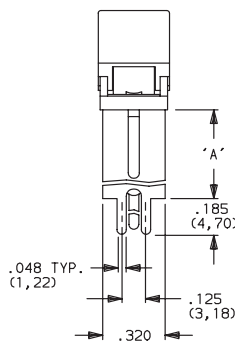
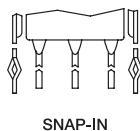

### PC MOUNTING

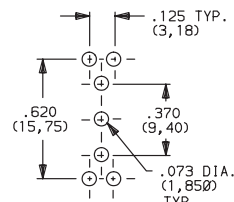

OPTION CODE	DIM 'A'
<b>V3, V31</b>	.460 (11,68)
<b>V4</b>	.630 (16,00)

**V3, V4** VERTICAL MOUNT, V-BRACKET

**V31** VERTICAL MOUNT, V-BRACKET, SNAP-IN

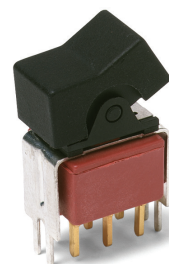

**E201J1\_BE2**  
**DPDT**

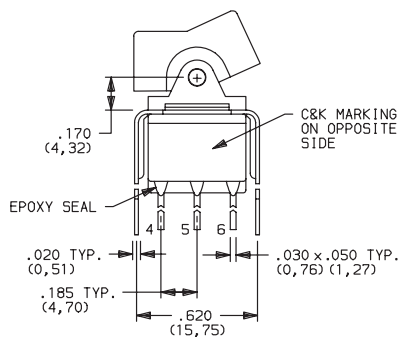

Actuator Shown In Pos. 1

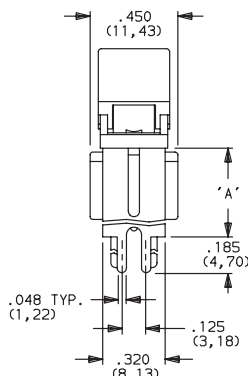
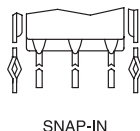

### PC MOUNTING

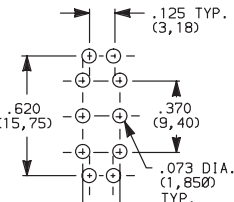

OPTION CODE	DIM 'A'
<b>V3, V31</b>	.460 (11,68)
<b>V4</b>	.630 (16,00)

**NOTE:** Available actuators, see pages G-27 thru G-29.

**V4** VERTICAL MOUNT, V-BRACKET

VERTICAL MOUNT, V-BRACKET, SNAP-IN

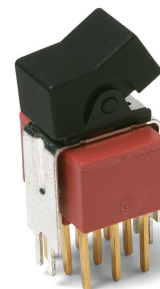

**E301J1\_BE2**  
**3PDT**

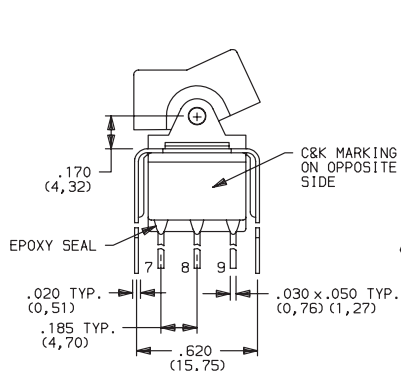

Actuator Shown In Pos. 1

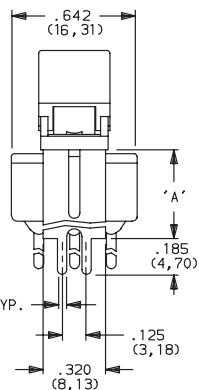
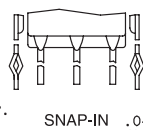

### PC MOUNTING

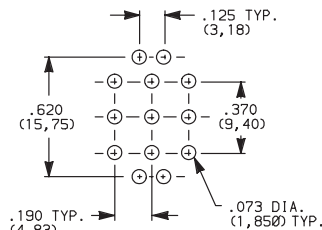

OPTION CODE	DIM 'A'
<b>V41</b>	.630 (16,00)

**NOTE:** Available actuators, see pages G-27 thru G-29.

Rocker



Dimensions are shown: Inches (mm)  
Specifications and dimensions subject to change



# E Series Sealed Miniature Rocker and Lever Handle Switches

## CONTACT MATERIAL

OPTION CODE	CONTACT MATERIAL	TERMINAL PLATING	RATINGS	
<b>B</b>	GOLD <sup>1</sup>	GOLD <sup>1</sup>	LOW LEVEL/ DRY CIRCUIT	0.4 VA MAX. @ 20 V AC OR DC MAX.
<b>P</b>		MATTE-TIN <sup>7</sup>		
<b>Q</b>	SILVER <sup>4,5</sup>	SILVER <sup>5</sup>	POWER	E1XX & E2XX MODELS: 7.5 AMPS @125 V AC OR 28 V DC; 3 AMPS @250 V AC. E3XX MODELS: 5 AMPS @ 125 V AC OR 28 V DC; 2 AMPS @ 250 V AC.
<b>S</b>		MATTE-TIN <sup>6</sup>		
<b>G</b>	GOLD OVER SILVER <sup>2,3</sup>	GOLD <sup>3</sup>	LOW LEVEL/DRY CIRCUIT OR POWER	E1XX AND E2XX MODELS: 0.4 VA MAX @20 V AC OR DC MAX. OR 7.5 AMPS @125 V AC OR 28 V DC; 3 AMPS @ 250 V AC. DC E3XX MODELS: 0.4 VA MAX. @ 20 V AC OR DC MAX. OR 5 AMPS @ 125 V AC OR 28 V DC; 2 AMPS @ 250 V AC.
<b>R</b>		MATTE-TIN <sup>6</sup>		

\* Note: See Technical Data section of this catalog for RoHS compliant and compatible definitions and specifications.

<sup>1</sup> CONTACTS & TERMINALS: Copper alloy, with gold plate over nickel plate.

<sup>2</sup> END CONTACTS: Coin silver, with gold plate over nickel plate.

<sup>3</sup> CENTER CONTACTS & ALL TERMINALS: Copper alloy, with gold plate over nickel plate.

<sup>4</sup> END CONTACTS: Coin silver, silver plated.

<sup>5</sup> CENTER CONTACT & ALL TERMINALS: Copper alloy, with gold flash over silver plate. Or copper alloy, silver plated.

<sup>6</sup> TERMINALS: Copper alloy, with matte-tin over nickel plate.

**NOTE:** Any models supplied with Q, B, G, S P & R contact material are RoHS compliant.

All models with all options when ordered with G, Q, S & R contact material.

B contact material standard with all terminations.

P R & S contact materials not available with Z terminations.

## SEAL

**E** EPOXY SEAL



## AVAILABLE HARDWARE

J2, J21 Actuators



PART NO.  
**760502263** BLACK  
**760503000** RED

Material: Nylon  
Finish: Matte

J3 Actuator



PART NO.  
**766602263** BLACK  
**766603000** RED

Material: Nylon  
Finish: Matte

J1, J11 Actuators



PART NO.  
**776A02263** BLACK  
**776A03000** RED

Material: Nylon  
Finish: Matte

J50 Actuator

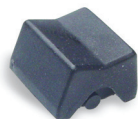

PART NO.  
**775A02263** BLACK  
**775A03000** RED

Material: Nylon  
Finish: Matte

J60 Actuator



PART NO.  
**613802263** BLACK  
**598103000** RED

Material: Nylon  
Finish: Matte

J90 Actuator



PART NO.  
**598002263** BLACK  
**598003000** RED

Material: Nylon  
Finish: Matte

NOTE: Additional nuts, screws and lockwashers available separately, see Technical Data section of this catalog. Other colors available, consult Customer Service Center.

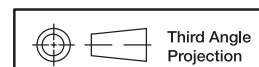

Dimensions are shown: Inches (mm)  
Specifications and dimensions subject to change

**C&K**

# E Series Sealed Miniature Rocker and Lever Handle Switches

## AVAILABLE HARDWARE

Fits Z3 Termination female connector



PART NO.  
**530100000**

Available in loose pieces.

Frame for J11, J21 Actuators



PART NO.  
**764500746** BLACK ENAMEL  
**764601106** RETAINING SPRING

Material: Spring Steel



J50, J60 & J90 Actuators

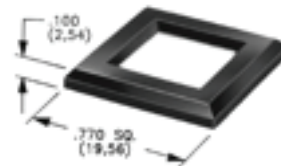

MATTE

PART NO.

**486702000**

Material: Nylon  
Finish: Matte or Gloss

GLOSS

PART NO.

**486802000** BLACK

**NOTE:** Additional nuts, screws and lockwashers available separately, see Technical Data section of this catalog. Other colors available, consult Customer Service Center.

Frames snap into panel opening and are independent from switch mounting. Accurate positioning of the PC mounted switch relative to the panel opening is necessary to provide proper clearance between actuator and frame. Available in two basic styles and four panel thicknesses .047-.125 in. Material: Nylon. Finish: Matte.

TYPICAL APPLICATION

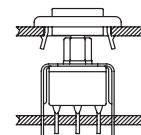

J1 & J2 Actuators

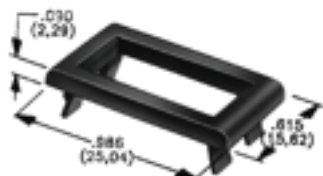

.047" (1,19) PANEL THK.    .062" (1,57) PANEL THK.    .090" (2,29) PANEL THK.    .125" (3,18) PANEL THK.

PART NO. <b>452902263</b> <b>452903000</b>	PART NO. <b>452702263</b> <b>452703000</b>	PART NO. <b>452802263</b> <b>452803000</b>	PART NO. <b>452602263</b> BLACK <b>452603000</b> RED
--	--	--	--

J50, J60 & J90 Actuators

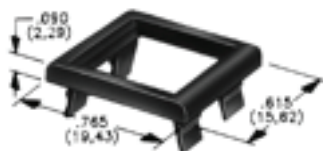

.047" (1,19) PANEL THK.    .062" (1,57) PANEL THK.    .090" (2,29) PANEL THK.    .125" (3,18) PANEL THK.

PART NO. <b>432502263</b> <b>432503000</b>	PART NO. <b>432602263</b> <b>432603000</b>	PART NO. <b>432702263</b> <b>432703000</b>	PART NO. <b>432802263</b> BLACK <b>432803000</b> RED
--	--	--	--

### PANEL MOUNTING

For part numbers  
4529xxxxx, 4527xxxxx,  
4528xxxxx, 4526xxxxx

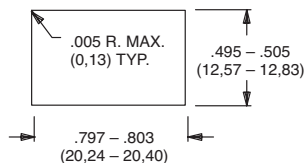

For part numbers  
4325xxxxx, 4326xxxxx

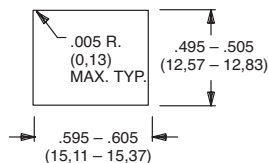

For part numbers  
4327xxxxx, 4328xxxxx

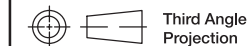
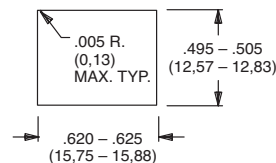

Dimensions are shown: Inches (mm)  
Specifications and dimensions subject to change

Rocker

G



# E Series Sealed Miniature Rocker and Lever Handle Switches

## AVAILABLE HARDWARE

### Panel Inserts

Will fit separate snap-in frames for J50, J60, J90 actuators.

Above frames (part nos. 432XXXXXX) are also available with insert which accepts LED for indicator light assembly. Order insert separately from frame. Blank insert panel (without hole for LED) also available. **LED not included.**

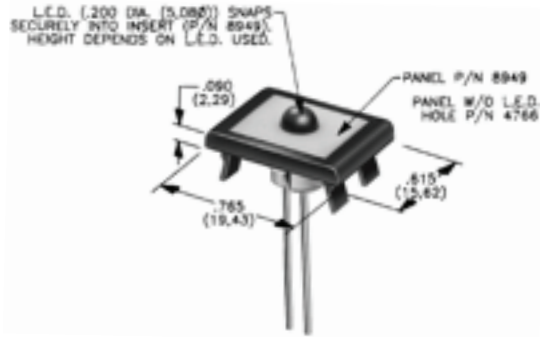

PANEL INSERT  
WITH HOLE FOR LED

BLANK PANEL INSERT  
WITHOUT HOLE FOR LED

PART NO.

**894902000**  
**894903000**

PART NO.

**476602000** BLACK  
**476603000** RED

NOTE: Special colors, custom markings available, consult Customer Service Center.



Компания «ЭлектроПласт» предлагает заключение долгосрочных отношений при поставках импортных электронных компонентов на взаимовыгодных условиях!

Наши преимущества:

- Оперативные поставки широкого спектра электронных компонентов отечественного и импортного производства напрямую от производителей и с крупнейших мировых складов;
- Поставка более 17-ти миллионов наименований электронных компонентов;
- Поставка сложных, дефицитных, либо снятых с производства позиций;
- Оперативные сроки поставки под заказ (от 5 рабочих дней);
- Экспресс доставка в любую точку России;
- Техническая поддержка проекта, помощь в подборе аналогов, поставка прототипов;
- Система менеджмента качества сертифицирована по Международному стандарту ISO 9001;
- Лицензия ФСБ на осуществление работ с использованием сведений, составляющих государственную тайну;
- Поставка специализированных компонентов (Xilinx, Altera, Analog Devices, Intersil, Interpoint, Microsemi, Aeroflex, Peregrine, Syfer, Eurofarad, Texas Instrument, Miteq, Cobham, E2V, MA-COM, Hittite, Mini-Circuits, General Dynamics и др.);

Помимо этого, одним из направлений компании «ЭлектроПласт» является направление «Источники питания». Мы предлагаем Вам помощь Конструкторского отдела:

- Подбор оптимального решения, техническое обоснование при выборе компонента;
- Подбор аналогов;
- Консультации по применению компонента;
- Поставка образцов и прототипов;
- Техническая поддержка проекта;
- Защита от снятия компонента с производства.



#### Как с нами связаться

**Телефон:** 8 (812) 309 58 32 (многоканальный)

**Факс:** 8 (812) 320-02-42

**Электронная почта:** [org@eplast1.ru](mailto:org@eplast1.ru)

**Адрес:** 198099, г. Санкт-Петербург, ул. Калинина, дом 2, корпус 4, литера А.