

MMBZ52xxELT1G Series, SZMMBZ52xxELT1G Series

Zener Voltage Regulators

225 mW SOT-23 Surface Mount

This series of Zener diodes is offered in the convenient, surface mount plastic SOT-23 package. These devices are designed to provide voltage regulation with minimum space requirement. They are well suited for applications such as cellular phones, hand held portables, and high density PC boards.

Features

- 225 mW Rating on FR-4 or FR-5 Board
- Zener Voltage Range – 2.4 V to 91 V
- Package Designed for Optimal Automated Board Assembly
- Small Package Size for High Density Applications
- ESD Rating of Class 3 (>16 kV) per Human Body Model
- Peak Power – 225 W (8 x 20 μ s)
- AEC-Q101 Qualified and PPAP Capable
- SZ Prefix for Automotive and Other Applications Requiring Unique Site and Control Change Requirements
- Pb-Free Packages are Available

Mechanical Characteristics:

CASE: Void-free, transfer-molded, thermosetting plastic case

FINISH: Corrosion resistant finish, easily solderable

MAXIMUM CASE TEMPERATURE FOR SOLDERING PURPOSES:

260°C for 10 Seconds

POLARITY: Cathode indicated by polarity band

FLAMMABILITY RATING: UL 94 V-0

MAXIMUM RATINGS

Rating	Symbol	Max	Unit
Peak Power Dissipation @ 20 μ s (Note 1) @ $T_L \leq 25^\circ\text{C}$	P_{pk}	225	W
Total Power Dissipation on FR-5 Board, (Note 2) @ $T_A = 25^\circ\text{C}$ Derated above 25°C	P_D	225 1.8	mW mW/°C
Thermal Resistance, Junction-to-Ambient	$R_{\theta JA}$	556	°C/W
Total Power Dissipation on Alumina Substrate, (Note 3) @ $T_A = 25^\circ\text{C}$ Derated above 25°C	P_D	300 2.4	mW mW/°C
Thermal Resistance, Junction-to-Ambient	$R_{\theta JA}$	417	°C/W
Junction and Storage Temperature Range	T_J, T_{stg}	-65 to +150	°C

Stresses exceeding Maximum Ratings may damage the device. Maximum Ratings are stress ratings only. Functional operation above the Recommended Operating Conditions is not implied. Extended exposure to stresses above the Recommended Operating Conditions may affect device reliability.

1. Nonrepetitive current pulse per Figure 9.
2. FR-5 = 1.0 X 0.75 X 0.62 in.
3. Alumina = 0.4 X 0.3 X 0.024 in., 99.5% alumina.



ON Semiconductor®

<http://onsemi.com>

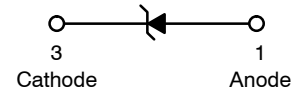

MARKING DIAGRAM

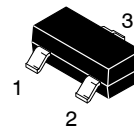

SOT-23
CASE 318
STYLE 8

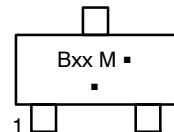

Bxx = Device Code
xx = (Refer to page 2)
M = Date Code*
▪ = Pb-Free Package

(Note: Microdot may be in either location)

*Date Code orientation may vary depending upon manufacturing location.

ORDERING INFORMATION

Device	Package	Shipping†
MMBZ52xxELT1G	SOT-23 (Pb-Free)	3000 / Tape & Reel
SZMMBZ52xxELT1G	SOT-23 (Pb-Free)	3000 / Tape & Reel
MMBZ52xxELT3G	SOT-23 (Pb-Free)	10000 / Tape & Reel

†For information on tape and reel specifications, including part orientation and tape sizes, please refer to our Tape and Reel Packaging Specifications Brochure, BRD8011/D.

DEVICE MARKING INFORMATION

See specific marking information in the device marking column of the Electrical Characteristics table on page 2 of this data sheet.

MMBZ52xxELT1G Series, SZMMBZ52xxELT1G Series

ELECTRICAL CHARACTERISTICS

(Pinout: 1-Anode, 2-No Connection, 3-Cathode) ($T_A = 25^\circ\text{C}$ unless otherwise noted, $V_F = 0.95\text{ V Max. @ } I_F = 10\text{ mA}$)

Symbol	Parameter
V_Z	Reverse Zener Voltage @ I_{ZT}
I_{ZT}	Reverse Current
Z_{ZT}	Maximum Zener Impedance @ I_{ZT}
I_{ZK}	Reverse Current
Z_{ZK}	Maximum Zener Impedance @ I_{ZK}
I_R	Reverse Leakage Current @ V_R
V_R	Reverse Voltage
I_F	Forward Current
V_F	Forward Voltage @ I_F

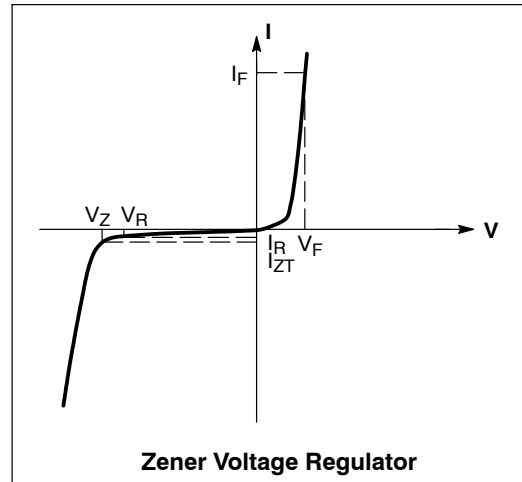

ELECTRICAL CHARACTERISTICS (Pinout: 1-Anode, 2-NC, 3-Cathode) ($V_F = 0.9\text{ V Max @ } I_F = 10\text{ mA}$ for all types.)

Device*	Device Marking	Zener Voltage (Note 4)				Zener Impedance			Leakage Current	
		V_Z (V)			@ I_{ZT}	Z_{ZT} @ I_{ZT}	Z_{ZK} @ I_{ZK}		I_R @ V_R	
		Min	Nom	Max	mA	Ω	Ω	mA	μA	V
MMBZ5221ELT1/T3G	BE2	2.28	2.4	2.52	20	30	1200	0.25	100	1
MMBZ5226ELT1/T3G	BE7	3.13	3.3	3.47	20	28	1600	0.25	25	1
MMBZ5228ELT1/T3G	BE9	3.70	3.9	4.10	20	23	1900	0.25	10	1
MMBZ5229ELT1/T3G	BF1	4.08	4.3	4.52	20	22	2000	0.25	5	1
MMBZ5230ELT1/T3G	BF2	4.46	4.7	4.94	20	19	1900	0.25	5	2
MMBZ5231ELT1/T3G	BF3	4.84	5.1	5.36	20	17	1600	0.25	5	2
MMBZ5232ELT1/T3G	BF4	5.32	5.6	5.88	20	11	1600	0.25	5	3
MMBZ5234ELT1/T3G	BF6	5.89	6.2	6.51	20	7	1000	0.25	5	4
MMBZ5235ELT1/T3G	BF7	6.46	6.8	7.14	20	5	750	0.25	3	5
MMBZ5236ELT1/T3G	BF8	7.12	7.5	7.88	20	6	500	0.25	3	6
MMBZ5237ELT1/T3G	BF9	7.79	8.2	8.61	20	8	500	0.25	3	6.5
MMBZ5239ELT1/T3G	BG2	8.65	9.1	9.55	20	10	600	0.25	3	7
MMBZ5240ELT1/T3G	BG3	9.50	10	10.50	20	17	600	0.25	3	8
MMBZ5242ELT1/T3G	BG5	11.40	12	12.60	20	30	600	0.25	1	9.1
MMBZ5243ELT1/T3G	BG6	12.35	13	13.65	9.5	13	600	0.25	0.5	9.9
MMBZ5244ELT1/T3G	BG7	13.30	14	14.70	9	15	600	0.25	0.1	10
MMBZ5245ELT1/T3G	BG8	14.25	15	15.75	8.5	16	600	0.25	0.1	11
MMBZ5246ELT1G†	BG9	15.20	16	16.80	7.8	17	600	0.25	0.1	12
MMBZ5248ELT1/T1G	BH2	17.10	18	18.90	7	21	600	0.25	0.1	14
MMBZ5250ELT1/T3G	BH4	19.00	20	21.00	6.2	25	600	0.25	0.1	15

4. Zener voltage is measured with a pulse test current I_Z at an ambient temperature of 25°C .

*Includes SZ-prefix devices where applicable.

†MMBZ5246EL, MMBZ5252EL, and MMBZ5265EL Not Available in 10,000/Tape & Reel.

MMBZ52xxELT1G Series, SZMMBZ52xxELT1G Series

ELECTRICAL CHARACTERISTICS (continued) (Pinout: 1-Anode, 2-NC, 3-Cathode) ($V_F = 0.9$ V Max @ $I_F = 10$ mA for all types.)

Device*	Device Marking	Zener Voltage (Note 5)				Zener Impedance			Leakage Current	
		V _Z (V)			@ I _{ZT}	Z _{ZT} @ I _{ZT}	Z _{ZK} @ I _{ZK}		I _R @ V _R	
		Min	Nom	Max	mA	Ω	Ω	mA	μA	V
MMBZ5252ELT1G†	BH6	22.80	24	25.20	5.2	33	600	0.25	0.1	18
MMBZ5253ELT1/T3G	BH7	23.75	25	26.25	5	35	600	0.25	0.1	19
MMBZ5254ELT1/T3G	BH8	25.65	27	28.35	4.6	41	600	0.25	0.1	21
MMBZ5255ELT1/T3G	BH9	26.60	28	29.40	4.5	44	600	0.25	0.1	21
MMBZ5256ELT1/T3G	BJ1	28.50	30	31.50	4.2	49	600	0.25	0.1	23
MMBZ5257ELT1/T3G	BJ2	31.35	33	34.65	3.8	58	700	0.25	0.1	25
MMBZ5258ELT1/T3G	BJ3	34.20	36	37.80	3.4	70	700	0.25	0.1	27
MMBZ5261ELT1G	BJ6	49.35	47	44.65	2.7	105	1000	0.25	0.1	36
MMBZ5262ELT1/T3G	BJ7	48.45	51	53.55	2.5	125	1100	0.25	0.1	37
MMBZ5263ELT1/T3G	BJ8	53.20	56	58.80	2.2	150	1300	0.25	0.1	43
MMBZ5265ELT1G†	BK1	58.90	62	65.10	2	185	1400	0.25	0.1	47

5. Zener voltage is measured with a pulse test current I_Z at an ambient temperature of 25°C.

*Includes SZ-prefix devices where applicable.

†MMBZ5246EL, MMBZ5252EL, and MMBZ5265EL Not Available in 10,000/Tape & Reel.

MMBZ52xxELT1G Series, SZMMBZ52xxELT1G Series

TYPICAL CHARACTERISTICS

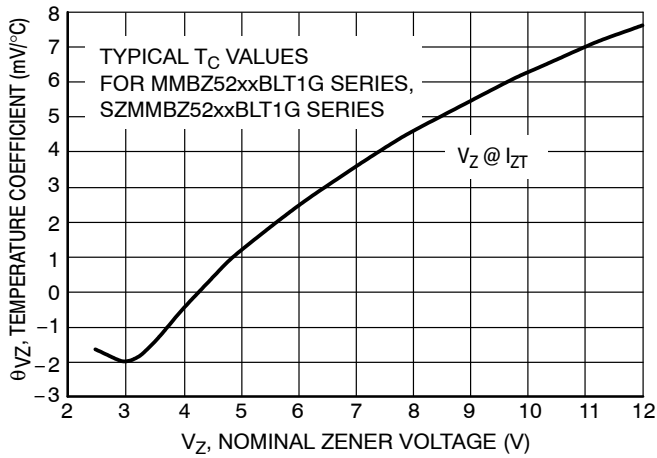

Figure 1. Temperature Coefficients
(Temperature Range -55°C to +150°C)

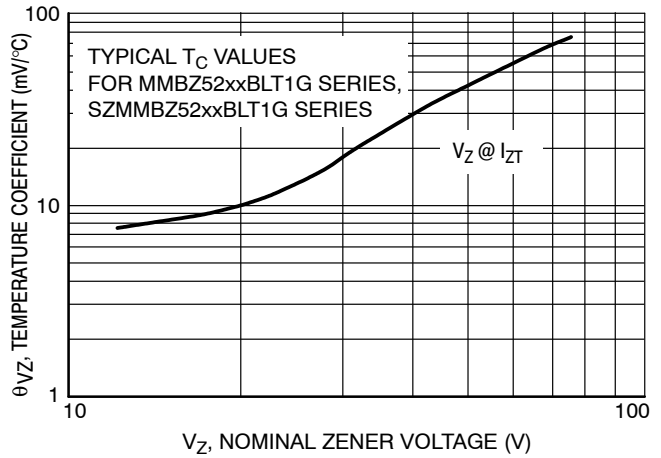

Figure 2. Temperature Coefficients
(Temperature Range -55°C to +150°C)

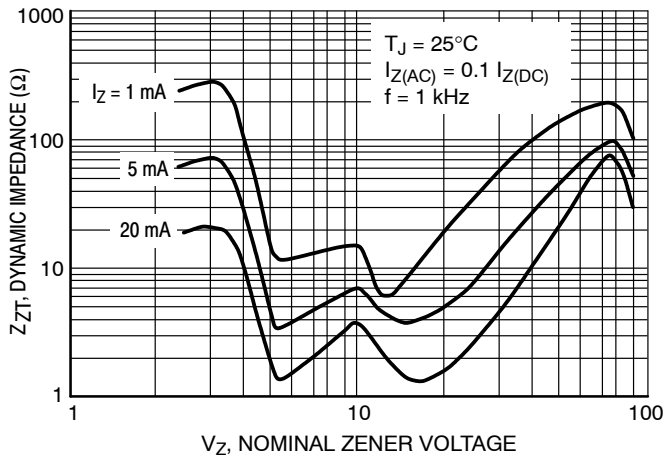

Figure 3. Effect of Zener Voltage on Zener Impedance

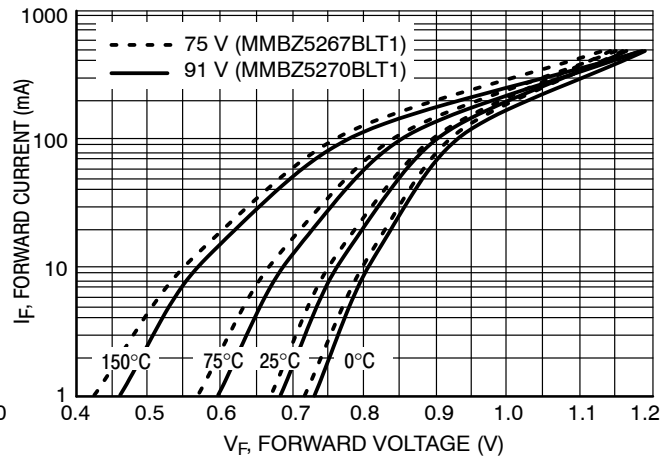

Figure 4. Typical Forward Voltage

MMBZ52xxELT1G Series, SZMMBZ52xxELT1G Series

TYPICAL CHARACTERISTICS

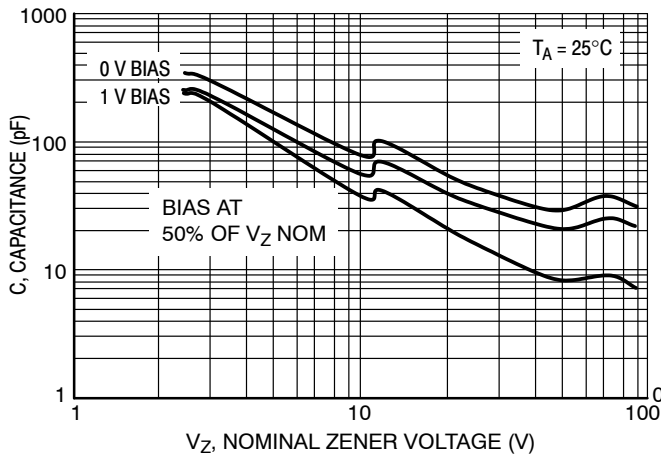

Figure 5. Typical Capacitance

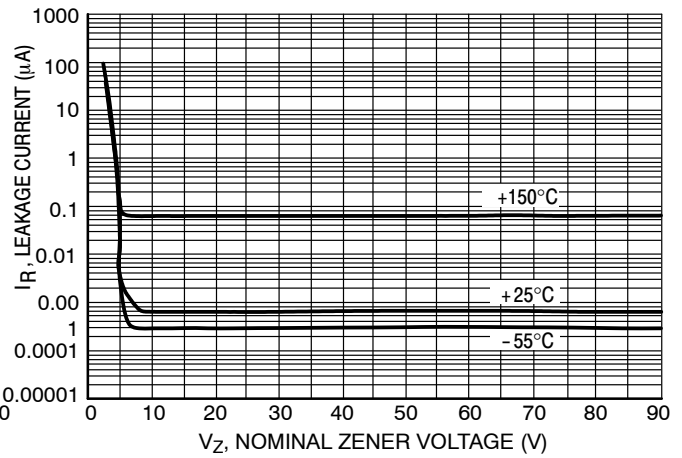

Figure 6. Typical Leakage Current

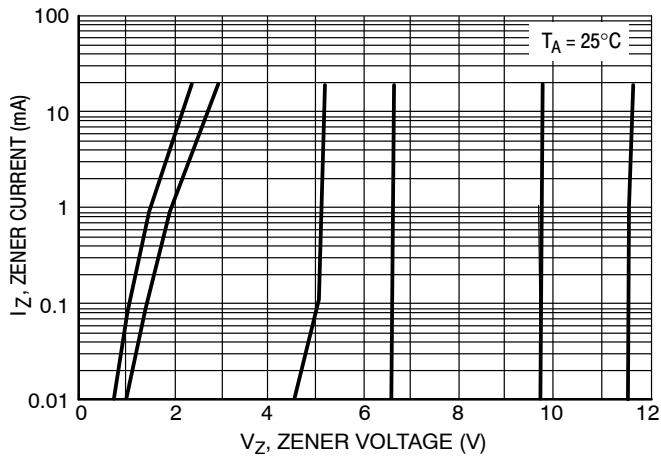

Figure 7. Zener Voltage versus Zener Current (V_Z Up to 12 V)

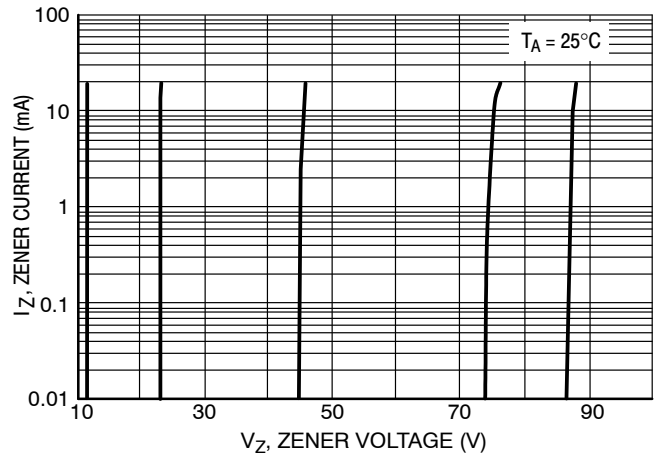

Figure 8. Zener Voltage versus Zener Current (12 V to 91 V)

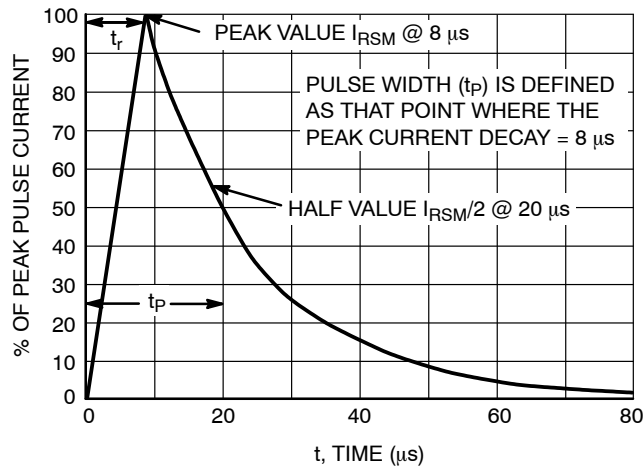
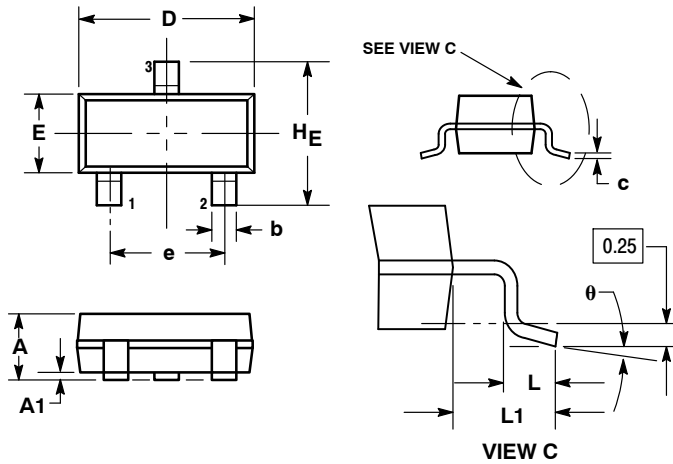

Figure 9. $8 \times 20 \mu\text{s}$ Pulse Waveform

MMBZ52xxELT1G Series, SZMMBZ52xxELT1G Series

PACKAGE DIMENSIONS

SOT-23 (TO-236)
CASE 318-08
ISSUE AP



- NOTES:
1. DIMENSIONING AND TOLERANCING PER ANSI Y14.5M, 1982.
 2. CONTROLLING DIMENSION: INCH.
 3. MAXIMUM LEAD THICKNESS INCLUDES LEAD FINISH THICKNESS. MINIMUM LEAD THICKNESS IS THE MINIMUM THICKNESS OF BASE MATERIAL.
 4. DIMENSIONS D AND E DO NOT INCLUDE MOLD FLASH, PROTRUSIONS, OR GATE BURRS.

DIM	MILLIMETERS			INCHES		
	MIN	NOM	MAX	MIN	NOM	MAX
A	0.89	1.00	1.11	0.035	0.040	0.044
A1	0.01	0.06	0.10	0.001	0.002	0.004
b	0.37	0.44	0.50	0.015	0.018	0.020
c	0.09	0.13	0.18	0.003	0.005	0.007
D	2.80	2.90	3.04	0.110	0.114	0.120
E	1.20	1.30	1.40	0.047	0.051	0.055
e	1.78	1.90	2.04	0.070	0.075	0.081
L	0.10	0.20	0.30	0.004	0.008	0.012
L1	0.35	0.54	0.69	0.014	0.021	0.029
HE	2.10	2.40	2.64	0.083	0.094	0.104
θ	0°	---	10°	0°	---	10°

- STYLE 8:
PIN 1. ANODE
2. NO CONNECTION
3. CATHODE

SOLDERING FOOTPRINT*

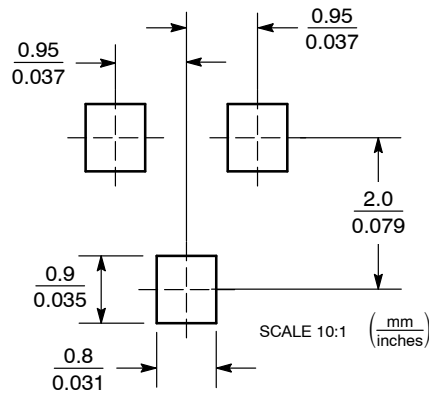

*For additional information on our Pb-Free strategy and soldering details, please download the ON Semiconductor Soldering and Mounting Techniques Reference Manual, SOLDERRM/D.

ON Semiconductor and are registered trademarks of Semiconductor Components Industries, LLC (SCILLC). SCILLC reserves the right to make changes without further notice to any products herein. SCILLC makes no warranty, representation or guarantee regarding the suitability of its products for any particular purpose, nor does SCILLC assume any liability arising out of the application or use of any product or circuit, and specifically disclaims any and all liability, including without limitation special, consequential or incidental damages. "Typical" parameters which may be provided in SCILLC data sheets and/or specifications can and do vary in different applications and actual performance may vary over time. All operating parameters, including "Typicals" must be validated for each customer application by customer's technical experts. SCILLC does not convey any license under its patent rights nor the rights of others. SCILLC products are not designed, intended, or authorized for use as components in systems intended for surgical implant into the body, or other applications intended to support or sustain life, or for any other application in which the failure of the SCILLC product could create a situation where personal injury or death may occur. Should Buyer purchase or use SCILLC products for any such unintended or unauthorized application, Buyer shall indemnify and hold SCILLC and its officers, employees, subsidiaries, affiliates, and distributors harmless against all claims, costs, damages, and expenses, and reasonable attorney fees arising out of, directly or indirectly, any claim of personal injury or death associated with such unintended or unauthorized use, even if such claim alleges that SCILLC was negligent regarding the design or manufacture of the part. SCILLC is an Equal Opportunity/Affirmative Action Employer. This literature is subject to all applicable copyright laws and is not for resale in any manner.

PUBLICATION ORDERING INFORMATION

LITERATURE FULFILLMENT:
Literature Distribution Center for ON Semiconductor
P.O. Box 5163, Denver, Colorado 80217 USA
Phone: 303-675-2175 or 800-344-3860 Toll Free USA/Canada
Fax: 303-675-2176 or 800-344-3867 Toll Free USA/Canada
Email: orderlit@onsemi.com

N. American Technical Support: 800-282-9855 Toll Free
USA/Canada
Europe, Middle East and Africa Technical Support:
Phone: 421 33 790 2910
Japan Customer Focus Center
Phone: 81-3-5817-1050

ON Semiconductor Website: www.onsemi.com
Order Literature: <http://www.onsemi.com/orderlit>

For additional information, please contact your local Sales Representative



Компания «ЭлектроПласт» предлагает заключение долгосрочных отношений при поставках импортных электронных компонентов на взаимовыгодных условиях!

Наши преимущества:

- Оперативные поставки широкого спектра электронных компонентов отечественного и импортного производства напрямую от производителей и с крупнейших мировых складов;
- Поставка более 17-ти миллионов наименований электронных компонентов;
- Поставка сложных, дефицитных, либо снятых с производства позиций;
- Оперативные сроки поставки под заказ (от 5 рабочих дней);
- Экспресс доставка в любую точку России;
- Техническая поддержка проекта, помощь в подборе аналогов, поставка прототипов;
- Система менеджмента качества сертифицирована по Международному стандарту ISO 9001;
- Лицензия ФСБ на осуществление работ с использованием сведений, составляющих государственную тайну;
- Поставка специализированных компонентов (Xilinx, Altera, Analog Devices, Intersil, Interpoint, Microsemi, Aeroflex, Peregrine, Syfer, Eurofarad, Texas Instrument, Miteq, Cobham, E2V, MA-COM, Hittite, Mini-Circuits, General Dynamics и др.);

Помимо этого, одним из направлений компании «ЭлектроПласт» является направление «Источники питания». Мы предлагаем Вам помощь Конструкторского отдела:

- Подбор оптимального решения, техническое обоснование при выборе компонента;
- Подбор аналогов;
- Консультации по применению компонента;
- Поставка образцов и прототипов;
- Техническая поддержка проекта;
- Защита от снятия компонента с производства.



Как с нами связаться

Телефон: 8 (812) 309 58 32 (многоканальный)

Факс: 8 (812) 320-02-42

Электронная почта: org@eplast1.ru

Адрес: 198099, г. Санкт-Петербург, ул. Калинина, дом 2, корпус 4, литера А.