

Ultra-low Quiescent Current ($I_Q = 0.3 \mu\text{A}$), 300 mA, Buck-Boost DC/DC Converter

No. EA-415-190507

OVERVIEW

The RP604x is a buck-boost converter featuring a minimum supply current and a high efficiency at low-load. The device operates at the low operating quiescent current ($I_Q = 0.3 \mu\text{A}$) to make the most of battery life for the battery driver operated intermittently.

KEY BENEFITS

- The low supply current ($I_Q = 0.3 \mu\text{A}$) can achieve making battery life longer and battery's size-reduction.
- Wide range of input voltage (1.8 V to 5.5 V) can support for every batteries from a coin-type battery to a USB port.
- Selectable package: WLCSP-20-P2 or DFN(PLP)2730-12

KEY SPECIFICATIONS

- Input Voltage: 1.8 V to 5.5 V
- Output Voltage: 1.6 V to 5.2 V, 0.1 V step
- Output Voltage Accuracy: $\pm 1.5\%$
- Maximum Output Current: 300 mA at Buck
- Built-in Driver On-resistance (RP604Z, $V_{IN} = 3.6 \text{ V}$): PMOS = Typ. 0.12Ω , NMOS = Typ. 0.12Ω
- Operating Quiescent Current (I_Q): $0.3 \mu\text{A}$
- Standby Current: $0.01 \mu\text{A}$
- Protection Features: UVLO, OVP, LX Peak Current, and Thermal Shutdown

TYPICAL CHARACTERISTICS

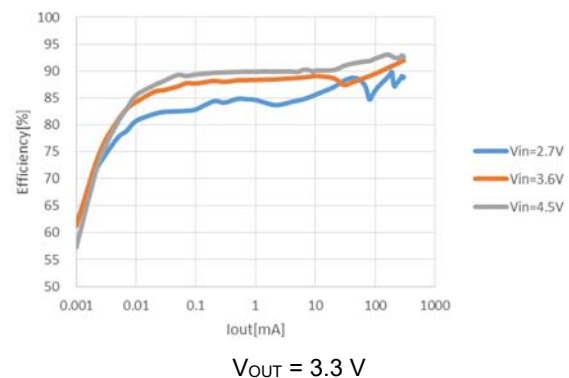

PACKAGES

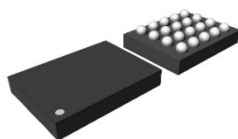

WLCSP-20-P2
1.71 x 2.315 x 0.40⁽¹⁾ mm
(¹) maximum dimension

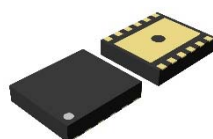

DFN(PLP)2730-12
2.70 x 3.00 x 0.6⁽¹⁾ mm
(¹) maximum dimension

OPTIONAL FUNCTIONS

The auto-discharge function and the set output voltage (V_{SET}) are user-selectable options.

Product Name	Auto-discharge Function	V_{SET}
RP604xxx1A	Disable	1.6 V to 5.2 V (0.1 V step)
RP604xxx1B	Enable	

APPLICATIONS

- Wearable Appliances: SmartWatch, SmartBand, Healthcare
- Li-ion/Coin Battery-used Equipment
- Low-power Wireless Communication Equipment: *Bluetooth*® Low Energy, ZigBee, WiSunm, ANT
- Low-power Devices for CPU, Memory, Sensor Device, Energy Harvesting

RP604x

No. EA-415-190507

SELECTION GUIDE

The set output voltage, the auto-discharge function⁽¹⁾ and the package are user-selectable options.

Selection Guide

Product Name	Package	Quantity per Reel	Pb Free	Halogen Free
RP604Zxx1\$-E2-F	WLCSP-20-P2	5,000 pcs	Yes	Yes
RP604Kxx1\$-TR	DFN(PLP)2730-12	5,000 pcs	Yes	Yes

xx: Specify the set output voltage (V_{SET}) within the range of 1.6 V (16) to 5.2 V (52) in 0.1 V steps.

\$: Specify the auto-discharge function.

Version	Auto-discharge Function	V_{SET}
A	Disable	1.6 V to 5.2 V
B	Enable	

BLOCK DIAGRAM

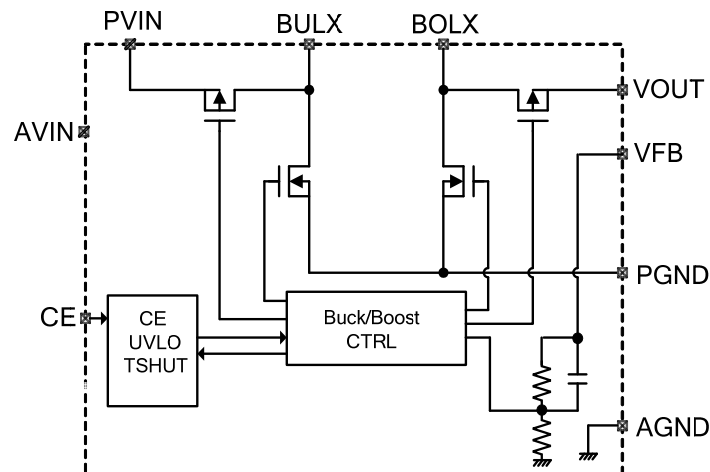

RP604xxx1A/ RP604xxx1B Block Diagram

⁽¹⁾ Auto-discharge function quickly lowers the output voltage to 0 V, when the chip enable signal is switched from the active mode to the standby mode, by releasing the electrical charge accumulated in the external capacitor.

PIN DESCRIPTIONS



WLCSP-20-P2 Pin Configuration

WLCSP-20-P2 Pin Description

Pin No.	Pin Name	Description
A5, B5, C5	VOUT	Output Voltage Pin
A4, B4, C4	BOLX	Boost Switching Output Pin
A3, B3, C3, D3	PGND	Power GND Pin
A2, B2, C2	BULX	Buck Switching Output Pin
A1, B1, C1	PVIN	Power Input Voltage Pin
D1	AVIN	Analog Power Input Voltage Pin
D2	CE	Chip Enable Pin, Active-high
D4	AGND	Analog GND Pin
D5	VFB	Output Voltage Feedback Pin

RP604x

No. EA-415-190507

**DFN(PLP)2730-12 Pin Configuration****DFN(PLP)2730-12 Pin Description**

Pin No.	Pin Name	Description
1	AVIN	Analog Power Input Voltage Pin
2	CE	Chip Enable Pin, Active-high
3	PGND	Power GND Pin
4	PGND	Power GND Pin
5	AGND	Analog GND Pin
6	VFB	Output Voltage Feedback Pin
7	VOUT	Output Voltage Pin
8	BOLX	Boost Switching Output Pin
9	PGND	Power GND Pin
10	PGND	Power GND Pin
11	BULX	Buck Switching Output Pin
12	PVIN	Power Input Voltage Pin

* The tab on the bottom of the package shown by blue circle is a substrate potential (GND). It is recommended that this tab be connected to the ground plane on the board but it is possible to leave the tab floating.

ABSOLUTE MAXIMUM RATINGS

Absolute Maximum Ratings (GND = 0 V)

Symbol	Parameter		Rating	Unit	
V_{IN}	A/PVIN Pin Voltage		-0.3 to 6.5	V	
V_{BULX}	BULX Pin Voltage		-0.3 to $V_{IN} + 0.3$	V	
V_{BOLX}	BOLX Pin Voltage		-0.3 to $V_{OUT} + 0.3$	V	
V_{CE}	CE Pin Voltage		-0.3 to 6.5	V	
V_{OUT}	VOUT Pin Voltage		-0.3 to 6.5	V	
V_{FB}	VFB Pin Voltage		-0.3 to 6.5	V	
I_{LX}	BULX/BOLX Pin Output Current		900	mA	
P_D	Power Dissipation ⁽¹⁾	WLCSP-20-P2	JEDEC STD. 51-9	1490	mW
		DFN(PLP)2730-12	JEDEC STD. 51-7	3100	mW
T_j	Junction Temperature Range		-40 to 125	°C	
T_{stg}	Storage Temperature Range		-55 to 125	°C	

ABSOLUTE MAXIMUM RATINGS

Electronic and mechanical stress momentarily exceeded absolute maximum ratings may cause permanent damage and may degrade the life time and safety for both device and system using the device in the field. The functional operation at or over these absolute maximum ratings are not assured.

RECOMMENDED OPERATING CONDITIONS

Recommended Operating Conditions

Symbol	Parameter	Rating	Unit
V_{IN}	Input Voltage	1.8 to 5.5	V
T_a	Operating Temperature Range	-40 to 85	°C

RECOMMENDED OPERATING CONDITIONS

All of electronic equipment should be designed that the mounted semiconductor devices operate within the recommended operating conditions. The semiconductor devices cannot operate normally over the recommended operating conditions, even if they are used over such conditions by momentary electronic noise or surge. And the semiconductor devices may receive serious damage when they continue to operate over the recommended operating conditions.

⁽¹⁾ Refer to *POWER DISSIPATION* for detailed information.

RP604x

No. EA-415-190507

ELECTRICAL CHARACTERISTICS

The specifications surrounded by are guaranteed by design engineering at $-40^{\circ}\text{C} \leq T_a \leq 85^{\circ}\text{C}$.

RP604Z/K Electrical Characteristics

($T_a = 25^{\circ}\text{C}$)

Symbol	Parameter	Test Conditions/Comments	Min.	Typ.	Max.	Unit
V_{OUT}	Output Voltage	$V_{\text{IN}} = V_{\text{CE}} = 3.6 \text{ V}$	x 0.985		x 1.015	V
I_{Q}	Operating Quiescent Current	$V_{\text{IN}} = V_{\text{CE}} = V_{\text{OUT}} = 3.6 \text{ V}$, $V_{\text{SET}} = 3.3 \text{ V}$ at rest		0.3		μA
I_{STANDBY}	Standby Current	$V_{\text{IN}} = 5.5 \text{ V}$, $V_{\text{CE}} = 0 \text{ V}$		0.01	1	μA
I_{CEH}	CE Pin Input Current, High	$V_{\text{IN}} = V_{\text{CE}} = 5.5 \text{ V}$	-0.025	0	0.025	μA
I_{CEL}	CE Pin Input Current, Low	$V_{\text{IN}} = 5.5 \text{ V}$, $V_{\text{CE}} = 0 \text{ V}$	-0.025	0	0.025	μA
I_{VOUTH}	VFB Pin Input Current, High	$V_{\text{IN}} = V_{\text{FB}} = 5.5 \text{ V}$, $V_{\text{CE}} = 0 \text{ V}$	-0.025	0	0.025	μA
I_{VOUTL}	VFB Pin Input Current, Low	$V_{\text{IN}} = 5.5 \text{ V}$, $V_{\text{CE}} = V_{\text{FB}} = 0 \text{ V}$	-0.025	0	0.025	μA
V_{OVP}	OVP Threshold Voltage	$V_{\text{IN}} = 3.6 \text{ V}$, rising (detection)		6.0		V
		$V_{\text{IN}} = 3.6 \text{ V}$, falling (release)		5.5		V
R_{DISN}	Auto-discharge NMOS On-resistance ⁽¹⁾	$V_{\text{IN}} = 3.6 \text{ V}$, $V_{\text{CE}} = 0 \text{ V}$		100		Ω
V_{CEH}	CE Pin Input Voltage, High	$V_{\text{IN}} = 5.5 \text{ V}$	1.0			V
V_{CEL}	CE Pin Input Voltage, Low	$V_{\text{IN}} = 2.0 \text{ V}$			0.4	V
R_{ONP}	PMOS On-resistance	RP604Z $V_{\text{IN}} = 3.6 \text{ V}$, $I_{\text{LX}} = -100 \text{ mA}$		0.12		Ω
		RP604K $V_{\text{IN}} = 3.6 \text{ V}$, $I_{\text{LX}} = -100 \text{ mA}$		0.15		Ω
R_{ONN}	NMOS On-resistance	RP604Z $V_{\text{IN}} = 3.6 \text{ V}$, $I_{\text{LX}} = -100 \text{ mA}$		0.12		Ω
		RP604K $V_{\text{IN}} = 3.6 \text{ V}$, $I_{\text{LX}} = -100 \text{ mA}$		0.15		Ω
T_{TSD}	Thermal Shutdown Threshold Temperature	T_{j} , rising (detection)		140		$^{\circ}\text{C}$
T_{TSR}		T_{j} , falling (release)		100		$^{\circ}\text{C}$
t_{START}	Soft-start Time	$V_{\text{IN}} = V_{\text{CE}} = 3.6 \text{ V}$		20		ms
I_{LXLIM}	LX Current Limit	$V_{\text{IN}} = V_{\text{CE}} = 3.6 \text{ V}$	600	900		mA
V_{UVLOF}	UVLO Threshold Voltage	$V_{\text{IN}} = V_{\text{CE}}$, falling (detection)	1.40	1.50	1.65	V
V_{UVLOR}		$V_{\text{IN}} = V_{\text{CE}}$, rising (release)	1.55	1.65	1.80	V

All test items listed under Electrical Characteristics are done under the pulse load condition ($T_{\text{j}} \approx T_a = 25^{\circ}\text{C}$). Unless otherwise noted, the test runs with "Open-loop Control" ($\text{GND} = 0 \text{ V}$).

⁽¹⁾ RP604xxx1B only

THEORY OF OPERATION

Soft-start Time

Starting-up with CE Pin

The IC starts to operate when the CE pin voltage (V_{CE}) exceeds the threshold voltage. The threshold voltage is preset between CE "H" input voltage (V_{CEH}) and CE "L" input voltage (V_{CEL}). After the start-up of the IC, soft-start circuit starts to operate. Then, after a certain period of time, the reference voltage (V_{REF}) in the IC gradually increases up to the specified value. Switching starts when V_{REF} reaches the preset voltage, and after that the output voltage rises accompanying V_{REF} 's increase. Soft-start time (t_{START}) starts when soft-start circuit is activated, and ends when the reference voltage reaches the specified voltage. Soft start time is not always equal to the turn-on speed of the DC/DC converter. Note that the turn-on speed could be affected by the power supply capacity, the output current, the inductance value and the C_{OUT} value.

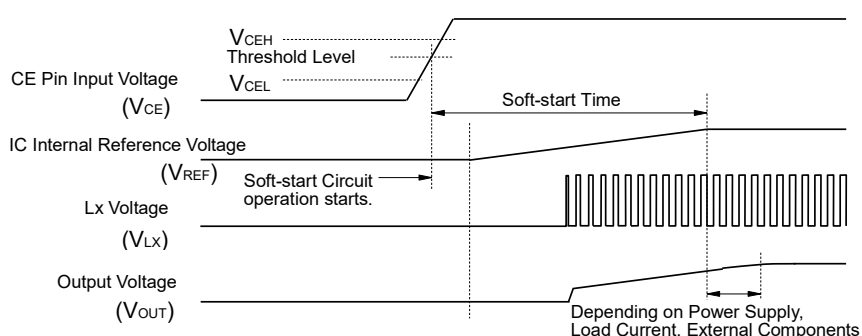

Timing Chart: Starting-up with CE Pin

Starting-up with Power Supply

After the power-on, when V_{IN} exceeds the UVLO released voltage (V_{UVLOR}), the IC starts to operate. Then, soft-start circuit starts to operate and after a certain period of time, V_{REF} gradually increases up to the specified value. Switching starts when V_{REF} reaches the preset voltage, and after that the output voltage rises accompanying V_{REF} 's increase. Soft-start time starts when soft-start circuit is activated, and ends when V_{REF} reaches the specified voltage. Note that the turn-on speed of V_{OUT} could be affected by the power supply capacity, the output current, the inductance value, the C_{OUT} value and the turn-on speed of V_{IN} determined by C_{IN} .

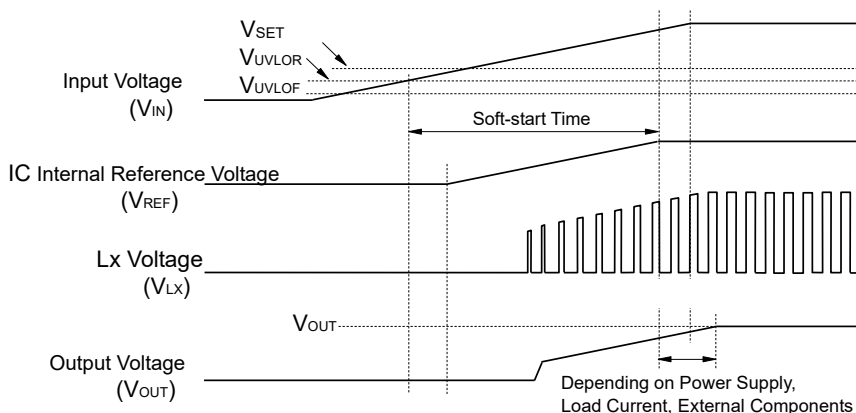

Timing Chart: Starting-up with Power Supply

RP604x

No. EA-415-190507

Undervoltage Lockout (UVLO) Circuit

If the V_{IN} becomes lower than the UVLO detector threshold (V_{UVLOF}), the UVLO circuit starts to operate, V_{REF} stops, and P-channel and N-channel built-in switch transistors turn "OFF". As a result, V_{OUT} drops according to the C_{OUT} capacitance value and the load. To restart the operation, V_{IN} needs to be higher than V_{UVLOR} .

Overvoltage Protection (OVP) Circuit

If the V_{OUT} becomes higher than the OVP detector threshold (V_{OVP}), the OVP circuit starts to operate, P-channel and N-channel built-in switch transistors turn "OFF". As a result, V_{OUT} drops according to the C_{OUT} capacitance value and the load.

Overcurrent Protection Circuit

Overcurrent protection circuit supervises the inductor peak current (the peak current flowing through Pch Tr (SW1) in each switching cycle, and if the current exceeds the BULX current limit (I_{LXLIM}), it turns off Pch Tr (SW1). I_{LXLIM} of the RP604x is set to Typ. 0.9 A.

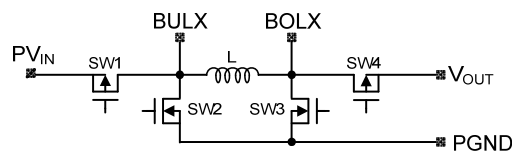

Simplified Diagram of Output Switches

APPLICATION INFORMATION

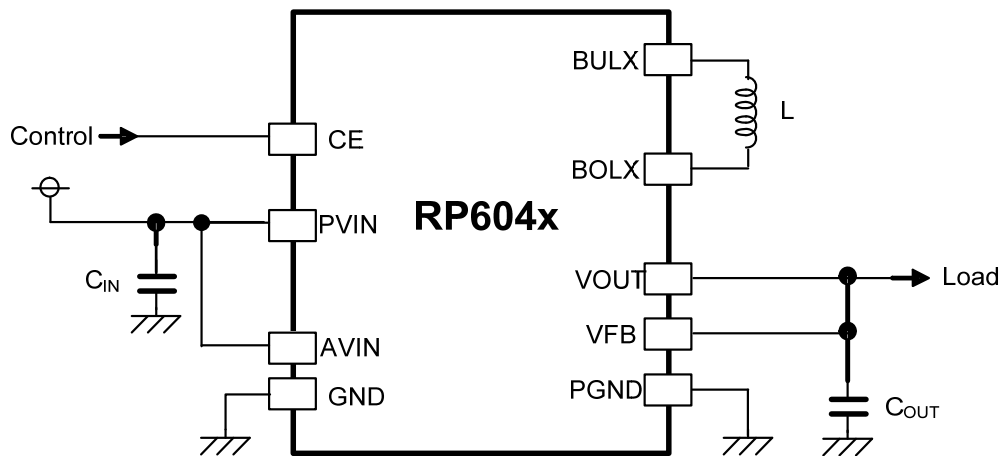

RP604x Typical Application Circuit

Recommended External Components

Symbol	Description
C _{IN}	10 μF or more, Ceramic Capacitor
C _{OUT}	22 μF, Ceramic Capacitor
L	2.2 μH, Inductor

Calculation Method of Peak Current of LX Pin (I_{LXMAX}) in Continuous Mode

The peak current of Lx pin (I_{LXMAX}) can be calculated as follows, in the case of an ideal buck converter operating in steady conditions, using the components listed in *Recommended External Components of APPLICATION INFORMATION*.

Ripple Current P-P value is described as I_{RP} , ON resistance of Pch Tr. is described as R_{ONP} , ON resistance of Nch Tr. is described as R_{ONN} , and DC resistor of the inductor is described as R_L .

First, when Pch Tr. is "ON", the following equation is satisfied.

$$V_{IN} = V_{OUT} + (R_{ONP} + R_L) \times I_{OUT} + L \times I_{RP} / t_{ON} \dots\dots\dots \text{Equation 1}$$

Second, when Pch Tr. is "OFF" (Nch Tr. is "ON"), the following equation is satisfied.

$$L \times I_{RP} / t_{OFF} = R_{ONN} \times I_{OUT} + V_{OUT} + R_L \times I_{OUT} \dots\dots\dots \text{Equation 2}$$

Put Equation 2 into Equation 1 to solve ON duty of Pch Tr. ($D_{ON} = t_{ON} / (t_{OFF} + t_{ON})$):

$$D_{ON} = (V_{OUT} + R_{ONN} \times I_{OUT} + R_L \times I_{OUT}) / (V_{IN} + R_{ONN} \times I_{OUT} - R_{ONP} \times I_{OUT}) \dots\dots\dots \text{Equation 3}$$

Ripple Current is described as follows:

$$I_{RP} = (V_{IN} - V_{OUT} - R_{ONP} \times I_{OUT} - R_L \times I_{OUT}) \times D_{ON} / f_{osc} / L \dots\dots\dots \text{Equation 4}$$

Peak current that flows through L, and Lx Tr. is described as follows:

$$I_{LXmax} = I_{OUT} + I_{RP} / 2 \dots\dots\dots \text{Equation 5}$$

The peak current of LX pin (I_{LXMAX}) can be calculated as follows, in the case of an ideal boost converter operating in steady conditions, using the components listed in *Recommended External Components* of *APPLICATION INFORMATION*.

Ripple Current P- P value is described as I_{RP} , Average inductor current is described as I_{LX} , ON resistance of Pch. Tr. and ON resistance of Nch. Tr. is described as R_{ONP} and R_{ONN} respectively, and DC resistor of the inductor is described as R_L .

First, when Nch. Tr. is "ON", the following equation is satisfied.

$$L \times I_{RP} / t_{ON} = V_{IN} - (R_L + R_{ONN}) \times I_{LX} \dots\dots\dots \text{Equation 6}$$

Second, when Nch. Tr. is "OFF" (Pch. Tr. is "ON"), the following equation is satisfied.

$$L \times I_{RP} / t_{OFF} = V_{OUT} + (R_L + R_{ONP}) \times I_{LX} - V_{IN} \dots\dots\dots \text{Equation 7}$$

Put Equation 7 into Equation 6 to solve ON duty of Nch. Tr. ($D_{ON} = t_{ON} / (t_{OFF} + t_{ON})$):

$$D_{ON} = (V_{OUT} - V_{IN} + R_L \times I_{LX} + R_{ONP} \times I_{LX}) / (V_{OUT} + R_{ONP} \times I_{LX} - R_{ONN} \times I_{LX}) \dots\dots\dots \text{Equation 8}$$

Ripple Current is described as follows:

$$I_{RP} = (V_{IN} - R_L \times I_{LX} - R_{ONN} \times I_{LX}) \times D_{ON} / f_{OSC} / L \dots\dots\dots \text{Equation 9}$$

Peak current that flows through L (I_{LMAX}), and LX Tr. is described as follows:

$$I_{LMAX} = I_{LX} + I_{RP} / 2 \dots\dots\dots \text{Equation 10}$$

Also, the average peak current (I_{OUT} and D_{ON}) in the boost circuit is described as follows:

$$I_{LX} = I_{OUT} / (1 - D_{ON}) \dots\dots\dots \text{Equation 11}$$

TECHNICAL NOTES

The performance of a power source circuit using this device is highly dependent on a peripheral circuit. A peripheral component or the device mounted on PCB should not exceed a rated voltage, a rated current or a rated power. When designing a peripheral circuit, please be fully aware of the following points. Refer to *PCB Layout* below.

- Use ceramic capacitors with a low equivalent series resistance (ESR), considering the bias characteristics and input/ output voltage.
- When the built-in switches are turned off, the inductor may generate a spike-shaped high voltage. Use the high-breakdown voltage capacitor (C_{OUT}) which output voltage is 1.5 times or more than the set output voltage.
- Use an inductor that has a low DC resistance, has an enough tolerable current and is less likely to cause magnetic saturation. If the inductance value is extremely small, the peak current of L_X may increase. When the peak current of L_X reaches to the L_X limit current (I_{LXLIM}), overcurrent protection circuit starts to operate. When selecting the inductor, consider the peak current of L_X pin (I_{LXMAX}). Refer to *Calculation Method of Peak Current of L_X Pin (I_{LXMAX}) in Continuous Mode* for details.
- When an intermediate voltage other than V_{IN} or GND is input to the CE pin, a supply current may be increased with a through current of a logic circuit in the IC. The CE pin is neither pulled up nor pulled down, therefore an operation is not stable at open.

PCB Layout

RP604Z (Package: WLCSP-20-P2) PCB Layout

Topside

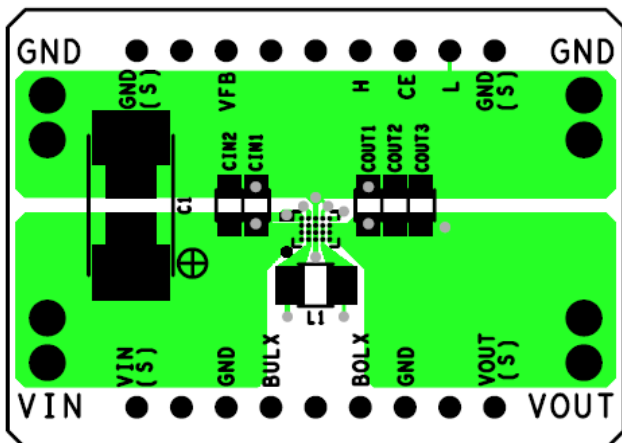

Backside

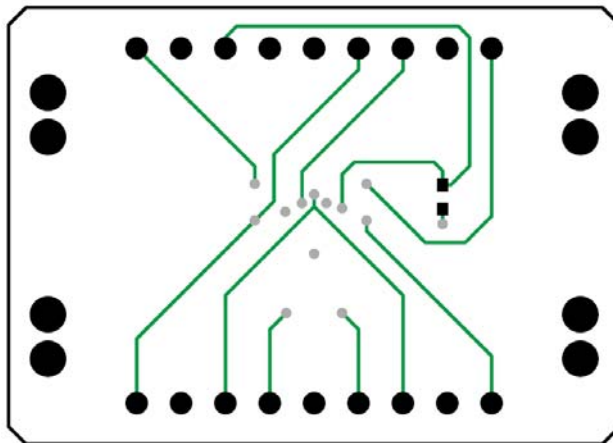

RP604K (Package: DFN(PLP)2730-12) PCB Layout

Topside

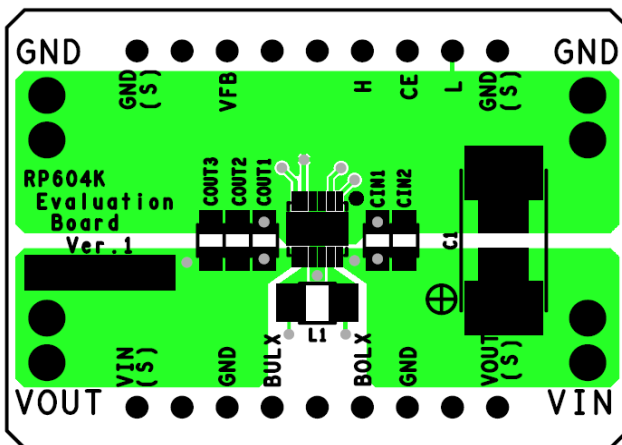

Backside

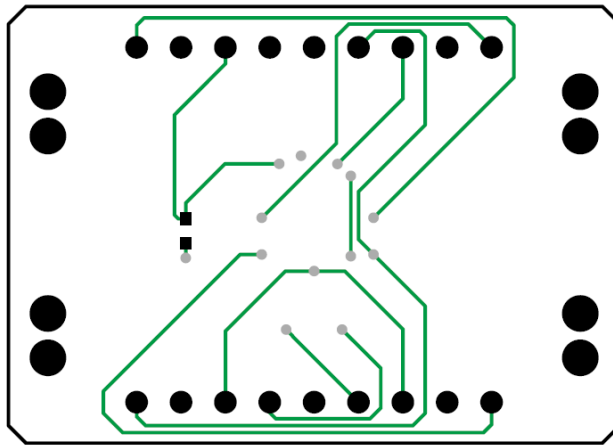

RP604x

No. EA-415-190507

TYPICAL CHARACTERISTICS

Note: Typical Characteristics are intended to be used as reference data; they are not guaranteed.

1) Output Current vs. Efficiency with Different Input Voltages RP604Z331x

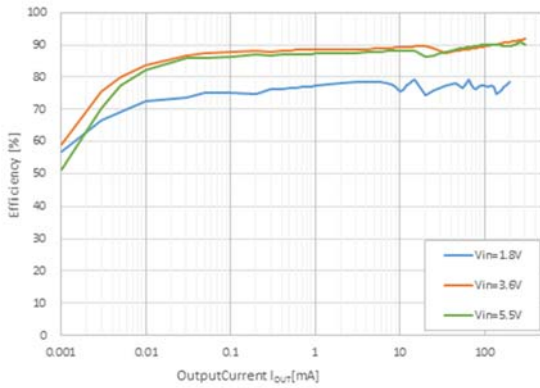

2) Output Current vs. Output Voltage with Different Input Voltages RP604Z331x

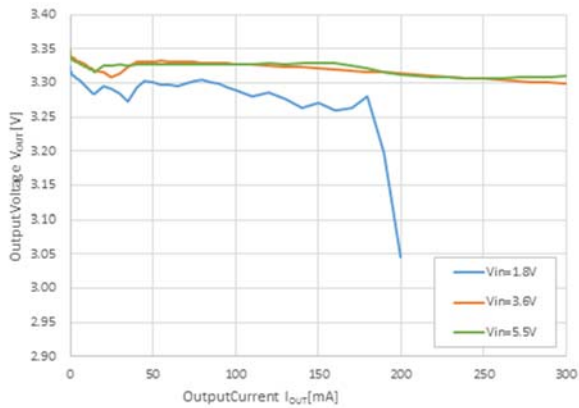

3) Temperature vs. Standby Current RP604Z331x, $V_{IN} = 5.5V$

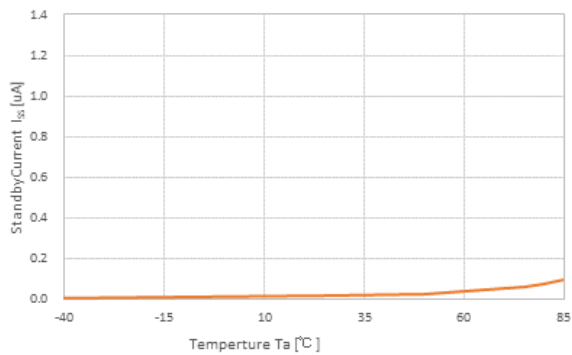

4) Input Voltage vs. Output Current

RP604Z161x, $I_{OUT} = (I_{IN} = 300 \text{ mA})$

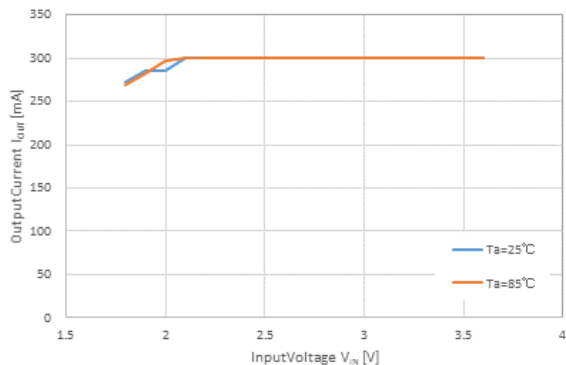

RP604Z331x, $I_{OUT} = (I_{IN} = 300 \text{ mA})$

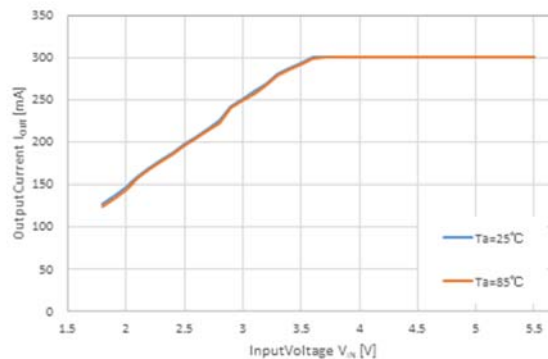

RP604Z521x, $I_{OUT} = (I_{IN} = 300 \text{ mA})$

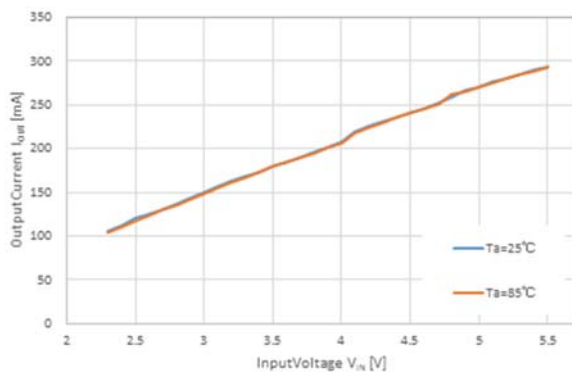

5) Output Ripple vs. Output Current

RP604Z331x

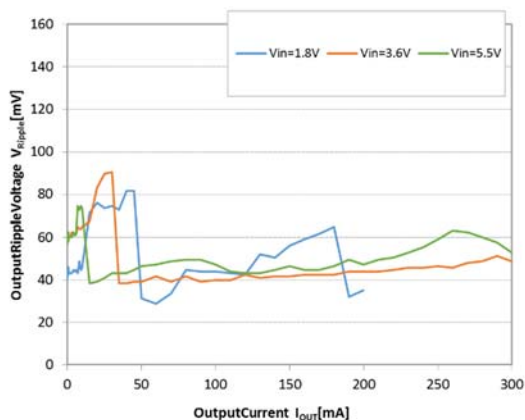

RP604x

No. EA-415-190507

6) Input Voltage vs. Output Voltage

RP604Z331X, $I_{OUT} = 1 \text{ mA}$

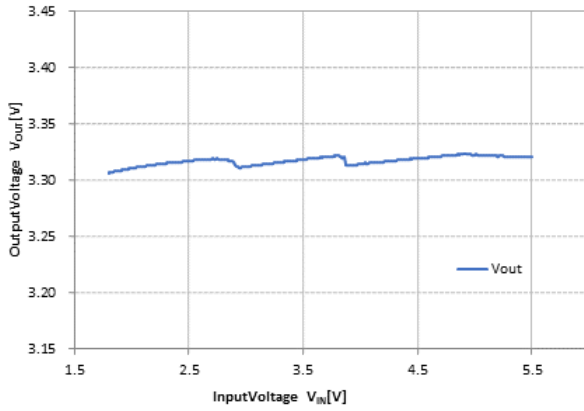

RP604Z331X, $I_{OUT} = 100 \text{ mA}$

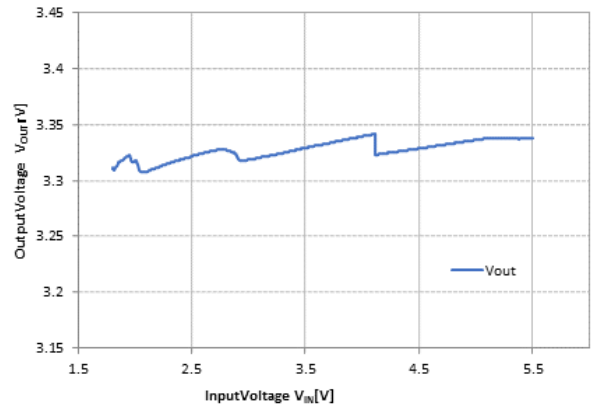

7) Starting-up/ Shutting-down Waveform with CE Pin

RP604Z331X, $I_{OUT} = 0 \text{ mA}$

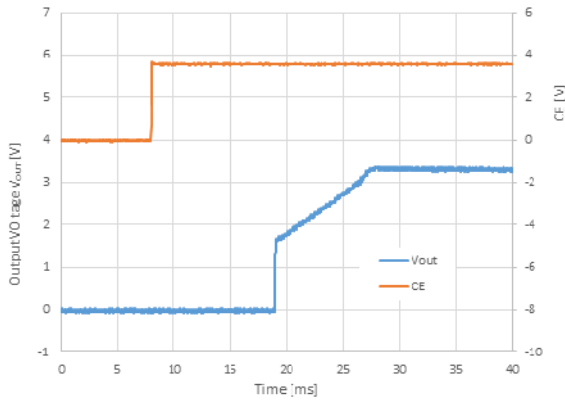

RP604Z331X, $I_{OUT} = 0 \text{ mA}$

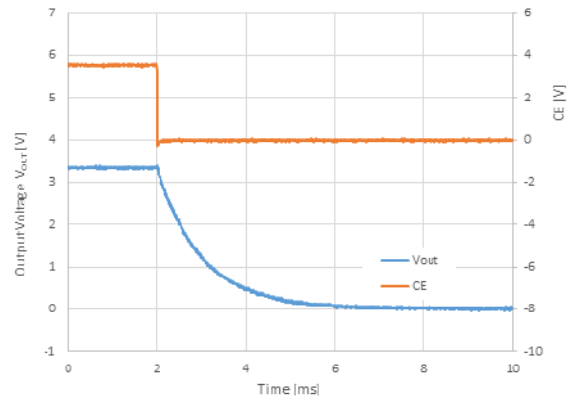

8) V_{OUT} Waveform

RP604Z331X, $V_{IN} = 3.6 \text{ V}$, $I_{OUT} = 10 \text{ mA}$

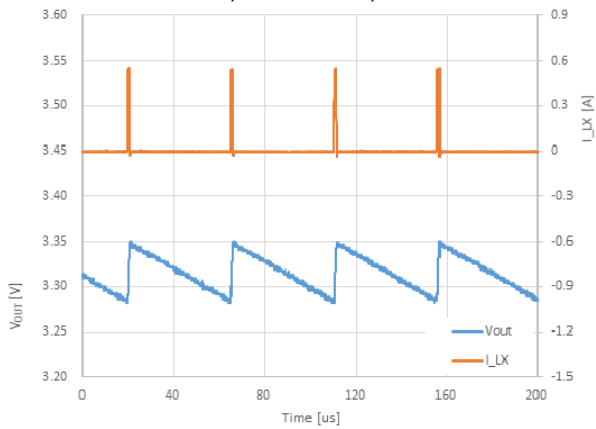

RP604Z331X, $V_{IN} = 3.6 \text{ V}$, $I_{OUT} = 100 \text{ mA}$

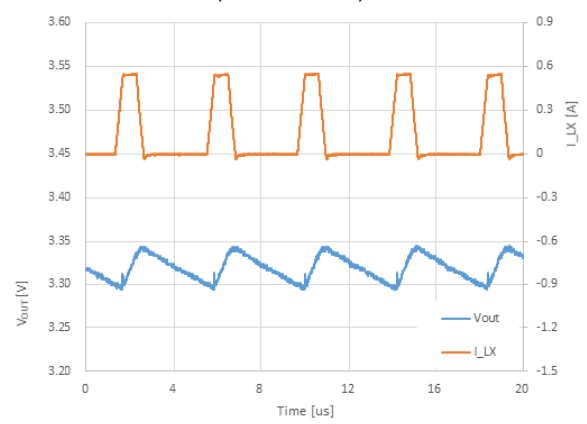

9) Load Transient Response

RP604Z331x, $V_{IN} = 3.6\text{ V}$, $I_{OUT} = 0.01\text{ mA} \leftrightarrow 100\text{ mA}$

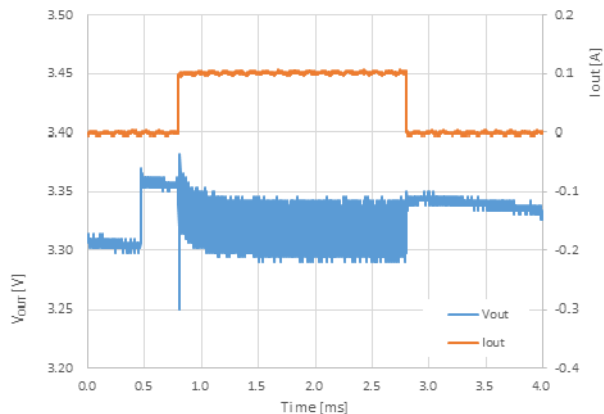

10) Input Transient Response

RP604Z331x, $V_{IN} = 2.5\text{ V} \leftrightarrow 4.5\text{ V}$, $I_{OUT} = 1\text{ mA}$

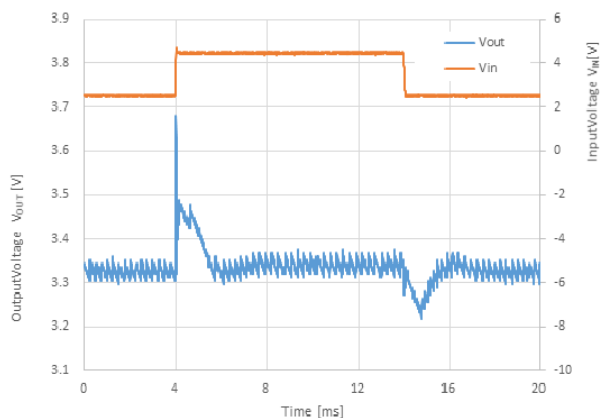

RP604Z331x, $V_{IN} = 2.5\text{ V} \leftrightarrow 4.5\text{ V}$, $I_{OUT} = 100\text{ mA}$

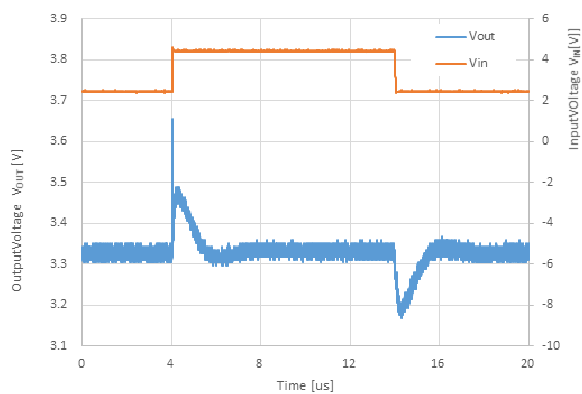

11) Temperature vs. Supply Current

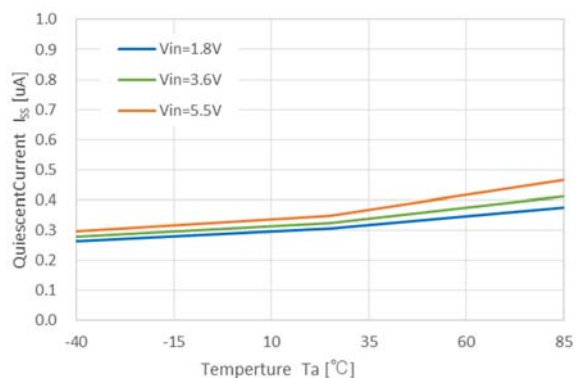

The power dissipation of the package is dependent on PCB material, layout, and environmental conditions. The following measurement conditions are based on JEDEC STD. 51-9.

Measurement Conditions

Item	Measurement Conditions
Environment	Mounting on Board (Wind Velocity = 0 m/s)
Board Material	Glass Cloth Epoxy Plastic (Four-Layer Board)
Board Dimensions	101.5 mm x 114.5 mm x 1.6 mm
Copper Ratio	Outer Layers (First and Fourth Layers): 60% Inner Layers (Second and Third Layers): 100%

Measurement Result

(Ta = 25°C, Tjmax = 125°C)

Item	Measurement Result
Power Dissipation	1490 mW
Thermal Resistance (θ_{ja})	$\theta_{ja} = 67 \text{ }^\circ\text{C/W}$

θ_{ja} : Junction-to-Ambient Thermal Resistance

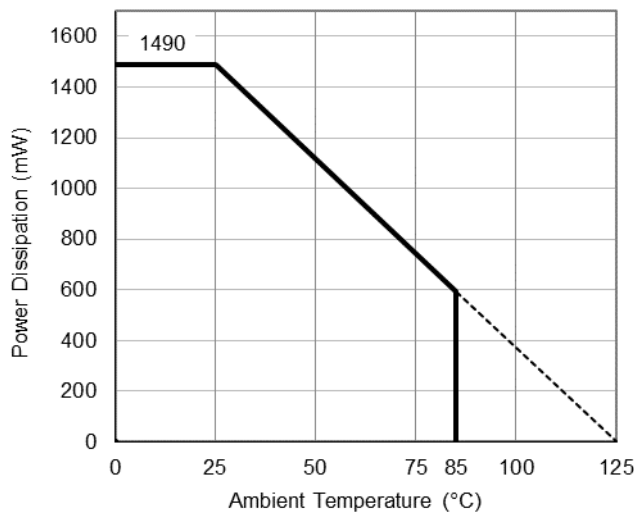

Power Dissipation vs. Ambient Temperature

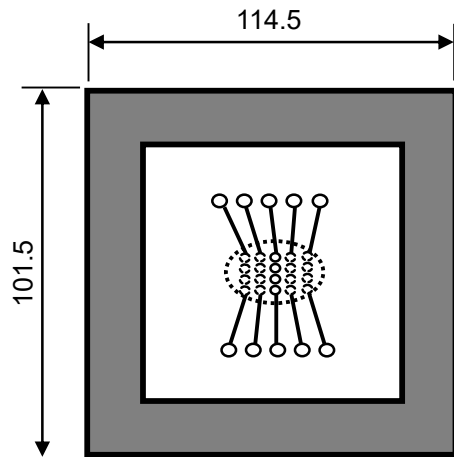

Measurement Board Pattern

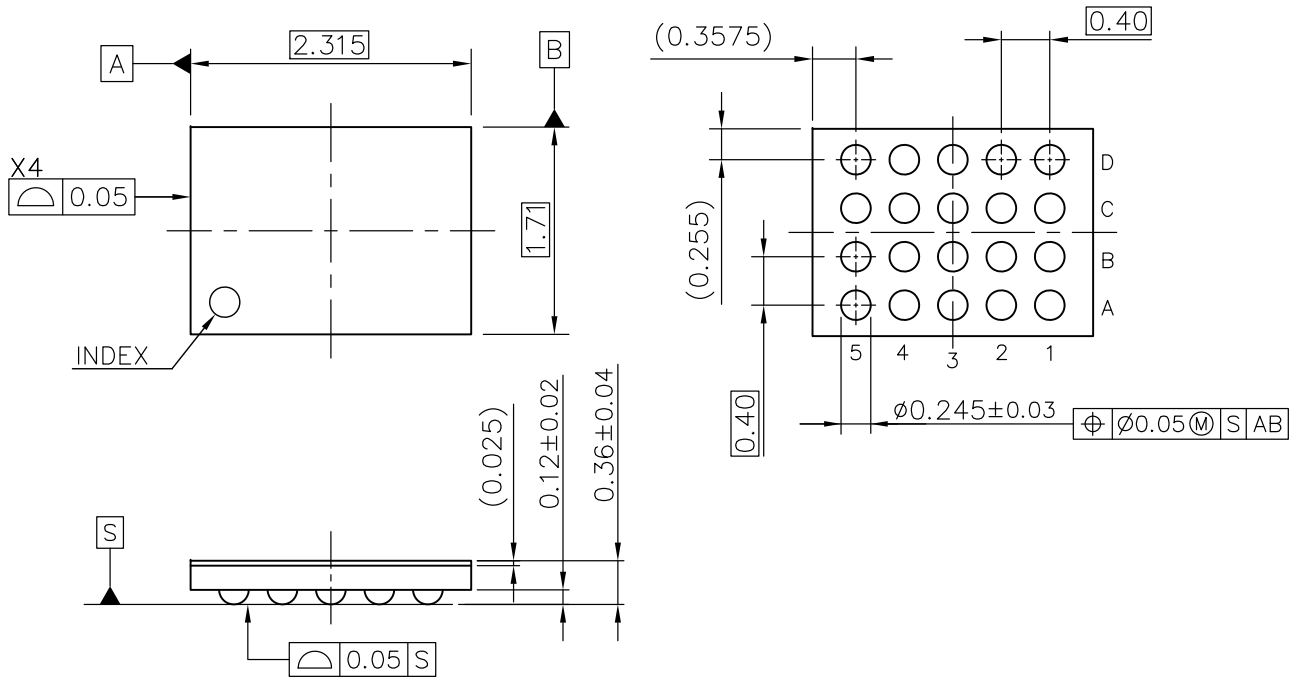

WLCSP-20-P2 Package Dimensions (Unit: mm)

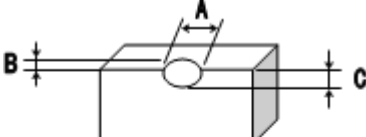
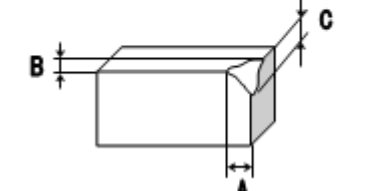
No.	Inspection Items	Inspection Criteria	Figure
1	Package chipping	<p>$A \geq 0.2\text{mm}$ is rejected $B \geq 0.2\text{mm}$ is rejected $C \geq 0.2\text{mm}$ is rejected And, Package chipping to Si surface and to bump is rejected.</p>	
2	Si surface chipping	<p>$A \geq 0.2\text{mm}$ is rejected $B \geq 0.2\text{mm}$ is rejected $C \geq 0.2\text{mm}$ is rejected But, even if $A \geq 0.2\text{mm}$, $B \leq 0.1\text{mm}$ is acceptable.</p>	
3	No bump	No bump is rejected.	
4	Marking miss	To reject incorrect marking, such as another product name marking or another lot No. marking.	
5	No marking	To reject no marking on the package.	
6	Reverse direction of marking	To reject reverse direction of marking character.	
7	Defective marking	To reject unreadable marking. (Microscope: X15/ White LED/ Viewed from vertical direction)	
8	Scratch	To reject unreadable marking character by scratch. (Microscope: X15/ White LED/ Viewed from vertical direction)	
9	Stain and Foreign material	To reject unreadable marking character by stain and foreign material. (Microscope: X15/ White LED/ Viewed from vertical direction)	

The power dissipation of the package is dependent on PCB material, layout, and environmental conditions. The following measurement conditions are based on JEDEC STD. 51-7.

Measurement Conditions

Item	Measurement Conditions
Environment	Mounting on Board (Wind Velocity = 0 m/s)
Board Material	Glass Cloth Epoxy Plastic (Four-Layer Board)
Board Dimensions	76.2 mm × 114.3 mm × 0.8 mm
Copper Ratio	Outer Layer (First Layer): Less than 95% of 50 mm Square Inner Layers (Second and Third Layers): Approx. 100% of 50 mm Square Outer Layer (Fourth Layer): Approx. 100% of 50 mm Square
Through-holes	φ 0.3 mm × 23 pcs

Measurement Result

(Ta = 25°C, Tjmax = 125°C)

Item	Measurement Result
Power Dissipation	3100 mW
Thermal Resistance (θ_{ja})	$\theta_{ja} = 32^{\circ}\text{C/W}$
Thermal Characterization Parameter (ψ_{jt})	$\psi_{jt} = 8^{\circ}\text{C/W}$

θ_{ja} : Junction-to-Ambient Thermal Resistance

ψ_{jt} : Junction-to-Top Thermal Characterization Parameter

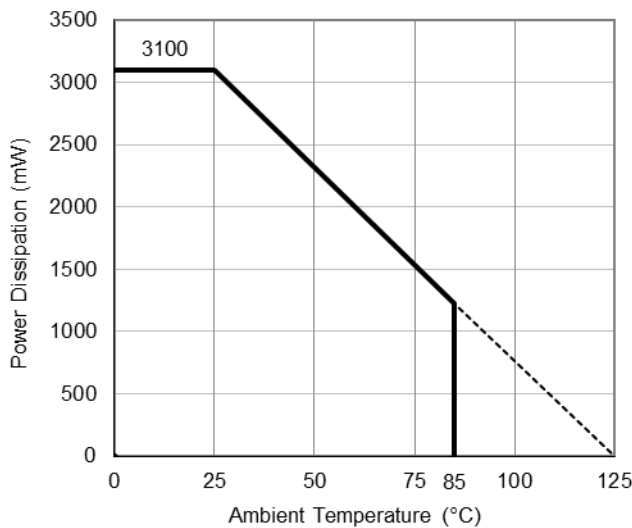

Power Dissipation vs. Ambient Temperature

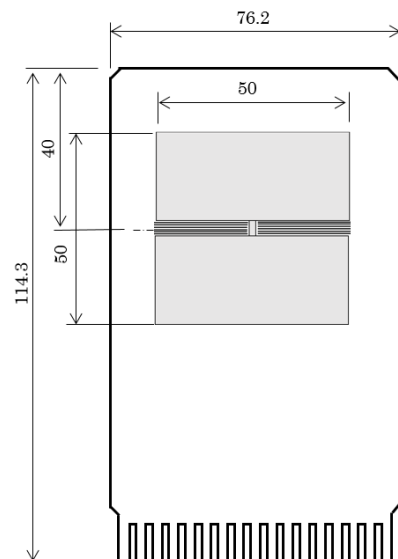

Measurement Board Pattern

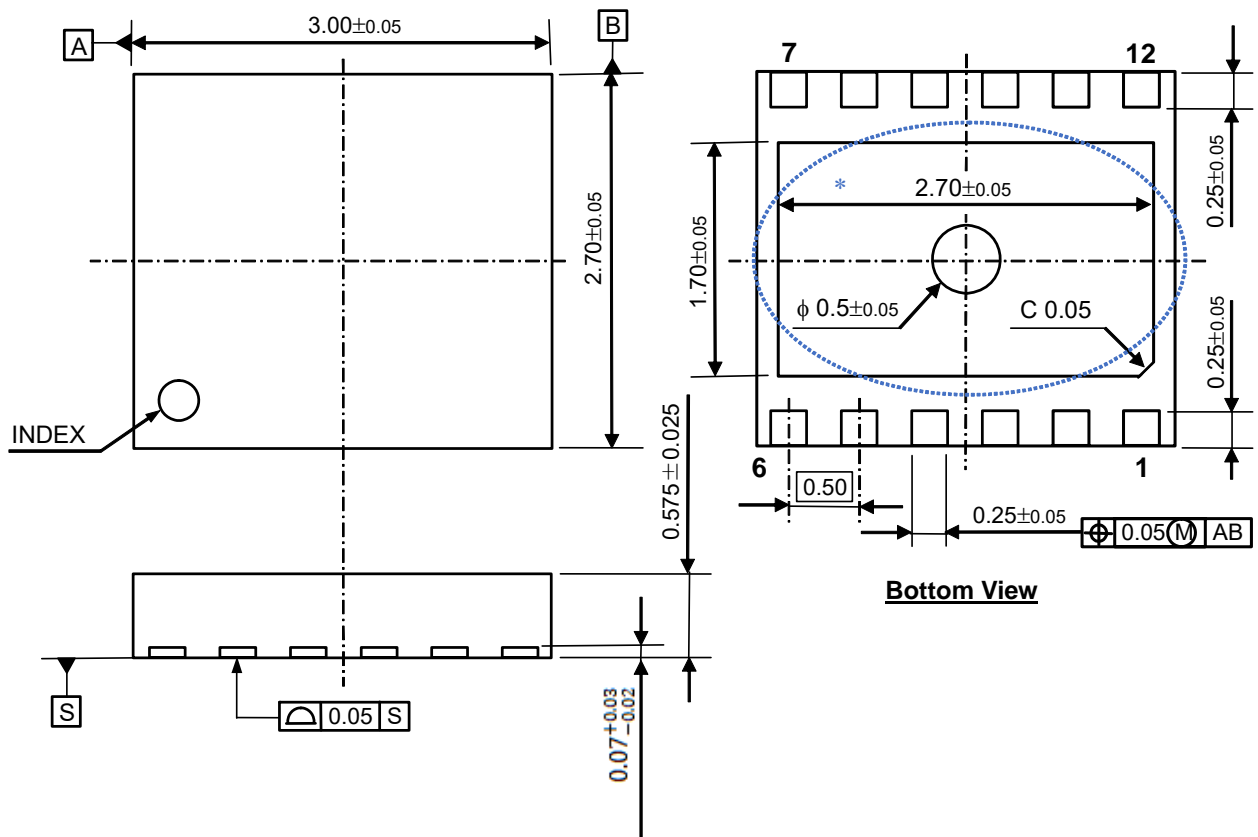

DFN(PLP)2730-12 Package Dimensions (Unit: mm)

*The tab on the bottom of the package shown by blue circle is a substrate potential (GND). It is recommended that this tab be connected to the ground plane on the board but it is possible to leave the tab floating.



1. The products and the product specifications described in this document are subject to change or discontinuation of production without notice for reasons such as improvement. Therefore, before deciding to use the products, please refer to Ricoh sales representatives for the latest information thereon.
2. The materials in this document may not be copied or otherwise reproduced in whole or in part without prior written consent of Ricoh.
3. Please be sure to take any necessary formalities under relevant laws or regulations before exporting or otherwise taking out of your country the products or the technical information described herein.
4. The technical information described in this document shows typical characteristics of and example application circuits for the products. The release of such information is not to be construed as a warranty of or a grant of license under Ricoh's or any third party's intellectual property rights or any other rights.
5. The products listed in this document are intended and designed for use as general electronic components in standard applications (office equipment, telecommunication equipment, measuring instruments, consumer electronic products, amusement equipment etc.). Those customers intending to use a product in an application requiring extreme quality and reliability, for example, in a highly specific application where the failure or misoperation of the product could result in human injury or death (aircraft, spacevehicle, nuclear reactor control system, traffic control system, automotive and transportation equipment, combustion equipment, safety devices, life support system etc.) should first contact us.
6. We are making our continuous effort to improve the quality and reliability of our products, but semiconductor products are likely to fail with certain probability. In order to prevent any injury to persons or damages to property resulting from such failure, customers should be careful enough to incorporate safety measures in their design, such as redundancy feature, fire containment feature and fail-safe feature. We do not assume any liability or responsibility for any loss or damage arising from misuse or inappropriate use of the products.
7. Anti-radiation design is not implemented in the products described in this document.
8. The X-ray exposure can influence functions and characteristics of the products. Confirm the product functions and characteristics in the evaluation stage.
9. WLCSP products should be used in light shielded environments. The light exposure can influence functions and characteristics of the products under operation or storage.
10. There can be variation in the marking when different AOI (Automated Optical Inspection) equipment is used. In the case of recognizing the marking characteristic with AOI, please contact Ricoh sales or our distributor before attempting to use AOI.
11. Please contact Ricoh sales representatives should you have any questions or comments concerning the products or the technical information.



Ricoh is committed to reducing the environmental loading materials in electrical devices with a view to contributing to the protection of human health and the environment.

Ricoh has been providing RoHS compliant products since April 1, 2006 and Halogen-free products since April 1, 2012.

RICOH RICOH ELECTRONIC DEVICES CO., LTD.

<https://www.e-devices.ricoh.co.jp/en/>

Sales & Support Offices

Ricoh Electronic Devices Co., Ltd.

Shin-Yokohama Office (International Sales)

2-3, Shin-Yokohama 3-chome, Kohoku-ku, Yokohama-shi, Kanagawa, 222-8530, Japan
Phone: +81-50-3814-7687 Fax: +81-45-474-0074

Ricoh Americas Holdings, Inc.

675 Campbell Technology Parkway, Suite 200 Campbell, CA 95008, U.S.A.
Phone: +1-408-610-3105

Ricoh Europe (Netherlands) B.V.

Semiconductor Support Centre

Prof. W.H. Keesomlaan 1, 1183 DJ Amstelveen, The Netherlands
Phone: +31-20-5474-309

Ricoh International B.V. - German Branch

Semiconductor Sales and Support Centre

Oberrather Strasse 6, 40472 Düsseldorf, Germany
Phone: +49-211-6546-0

Ricoh Electronic Devices Korea Co., Ltd.

3F, Haesung Bldg, 504, Teheran-ro, Gangnam-gu, Seoul, 135-725, Korea
Phone: +82-2-2135-5700 Fax: +82-2-2051-5713

Ricoh Electronic Devices Shanghai Co., Ltd.

Room 403, No.2 Building, No.690 Bibo Road, Pu Dong New District, Shanghai 201203,
People's Republic of China
Phone: +86-21-5027-3200 Fax: +86-21-5027-3299

Ricoh Electronic Devices Shanghai Co., Ltd.

Shenzhen Branch

1205, Block D (Jinlong Building), Kingkey 100, Hongbao Road, Luohu District,
Shenzhen, China
Phone: +86-755-8348-7600 Ext 225

Ricoh Electronic Devices Co., Ltd.

Taipei office

Room 109, 10F-1, No.51, Hengyang Rd., Taipei City, Taiwan
Phone: +886-2-2313-1621/1622 Fax: +886-2-2313-1623

Mouser Electronics

Authorized Distributor

Click to View Pricing, Inventory, Delivery & Lifecycle Information:

[Ricoch Electronics:](#)

[RP604K501A-TR](#) [RP604K261A-TR](#) [RP604K281A-TR](#) [RP604K301A-TR](#) [RP604K361B-TR](#)



Компания «ЭлектроПласт» предлагает заключение долгосрочных отношений при поставках импортных электронных компонентов на взаимовыгодных условиях!

Наши преимущества:

- Оперативные поставки широкого спектра электронных компонентов отечественного и импортного производства напрямую от производителей и с крупнейших мировых складов;
- Поставка более 17-ти миллионов наименований электронных компонентов;
- Поставка сложных, дефицитных, либо снятых с производства позиций;
- Оперативные сроки поставки под заказ (от 5 рабочих дней);
- Экспресс доставка в любую точку России;
- Техническая поддержка проекта, помощь в подборе аналогов, поставка прототипов;
- Система менеджмента качества сертифицирована по Международному стандарту ISO 9001;
- Лицензия ФСБ на осуществление работ с использованием сведений, составляющих государственную тайну;
- Поставка специализированных компонентов (Xilinx, Altera, Analog Devices, Intersil, Interpoint, Microsemi, Aeroflex, Peregrine, Syfer, Eurofarad, Texas Instrument, Miteq, Cobham, E2V, MA-COM, Hittite, Mini-Circuits, General Dynamics и др.);

Помимо этого, одним из направлений компании «ЭлектроПласт» является направление «Источники питания». Мы предлагаем Вам помощь Конструкторского отдела:

- Подбор оптимального решения, техническое обоснование при выборе компонента;
- Подбор аналогов;
- Консультации по применению компонента;
- Поставка образцов и прототипов;
- Техническая поддержка проекта;
- Защита от снятия компонента с производства.



Как с нами связаться

Телефон: 8 (812) 309 58 32 (многоканальный)

Факс: 8 (812) 320-02-42

Электронная почта: org@eplast1.ru

Адрес: 198099, г. Санкт-Петербург, ул. Калинина, дом 2, корпус 4, литера А.