

# SPPJ2 2.5mm-travel Horizontal Type

Switches with a lever height of 5.5mm, directly mountable onto set product

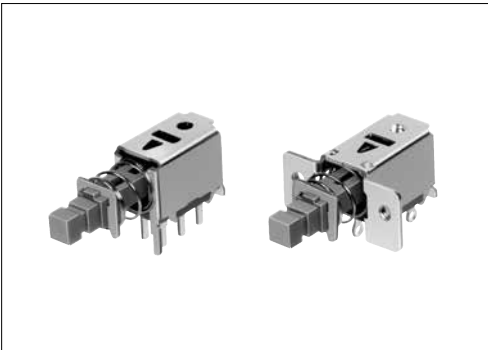

## Typical Specifications

Items		Specifications
Rating (max.)/(min.) (Resistive load)		0.2A 30V DC / 50μA 3V DC
Contact resistance (Initial/After operating life)		20mΩ max. / 40mΩ max.
Operating force		3±1.5N
Operating life	Without load	10,000 cycles
	With load	10,000 cycles (0.2A 30V DC)

## Product Line

Changeover timing	Travel (mm)	Total travel (mm)	Mounting method	Poles	Operation	Terminal type	Minimum order unit (pcs.)		Product No.	Drawing No.
							Japan	Export		
Non shorting	2.5	3.5	PC board	2	Latching	For PC board	700	3,500	<b>SPPJ222200</b>	1
					Momentary				<b>SPPJ223200</b>	
			M2-screw		Latching	For Lead	500	2,500	<b>SPPJ225800</b>	2
					Momentary				<b>SPPJ226400</b>	

## Packing Specifications

Bulk

Product No.	Number of packages (pcs.)		Export package measurements (mm)
	1 case / Japan	1 case / export packing	
<b>SPPJ222200</b> <b>SPPJ223200</b>	700	3,500	400×270×290
<b>SPPJ225800</b> <b>SPPJ226400</b>	500	2,500	

## Dimensions

No.	Style	PC board mounting hole dimensions (Viewed from the direction A)
1	<p><b>For PC board</b></p>	

Refer to P.130 for soldering conditions.

# SPPJ2 2.5mm-travel Horizontal Type

Detector

Slide

Push

Rotary

Power

Dual-in-line  
Package Type

Horizontal  
Type

Vertical  
Type

## ■ Dimensions

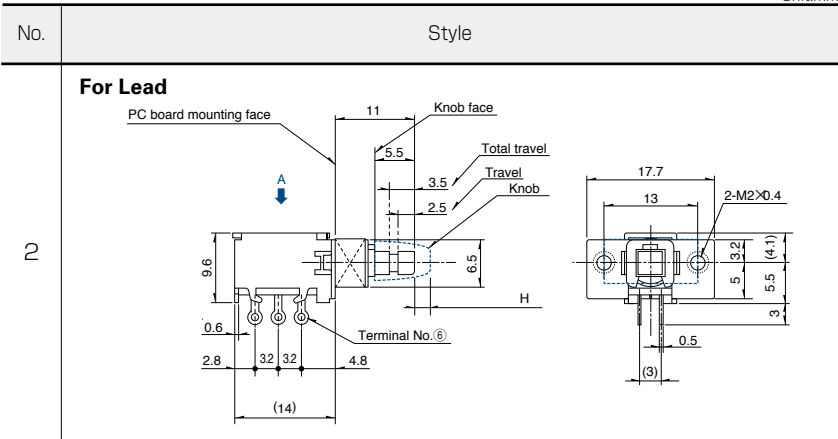

## ■ Actuator Configuration at Front Edge

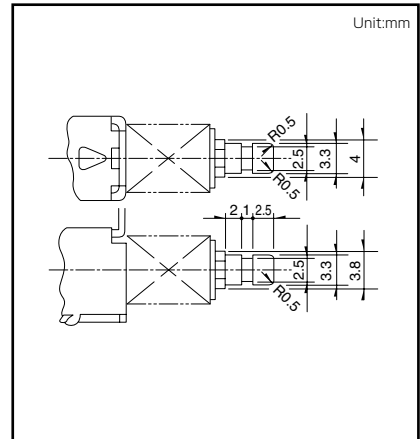

## ■ Terminal Configuration

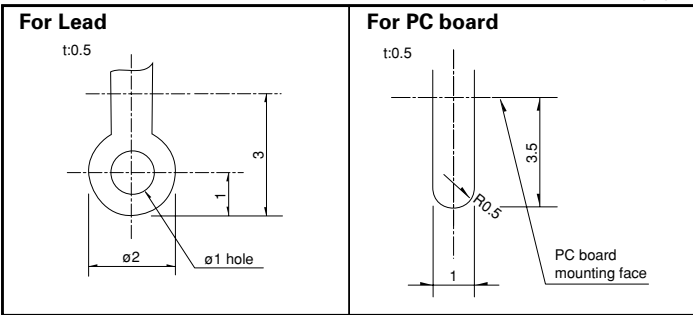

## ■ Circuit Diagram (Viewed from Direction A)

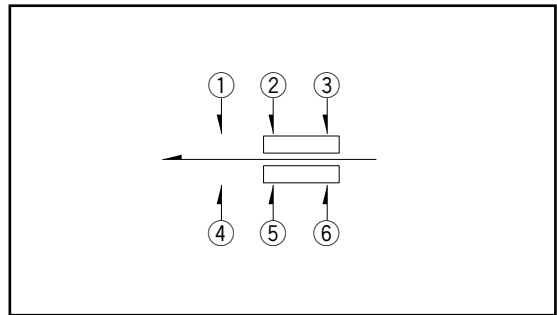

## ■ Attached Parts Please specify required knob.

Unit:mm

Knob outline drawing	Model	Knob attachment height (H)
<p>Square knob</p>	<p>Color:Black</p> <p><b>UE201011</b></p>	5
<p>Round knob</p>	<p>Color:Black</p> <p><b>UE200011</b></p>	9





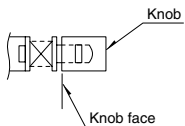





## Notes

- Other knob varieties are also available. Please inquire.
- We recommend the use of adhesive to secure the knob when mounting onto switches.



# Push Switches

## List of Varieties

Series		Horizontal				
		SPPJ3	SPPJ2	SPUJ	SPUN	SPUN medium current
Photo						
Dimensions (mm)	W	5 or 6.6	7.2	7.5	10	
	D	12		15.2 22.7	24 36	
	H	8.3	9.6	8.8	13	
Travel (mm)		2.5		2	2.5	
Total travel (mm)		3.5		3	3.5	
Number of poles		1 2	2	2 4		
Operating temperature range		-40°C to +85°C		-10°C to +60°C		
Automotive use		●	●	—	—	—
Life cycle						
Rating (max.) (Resistive load)		0.2A 30V DC		0.1A 30V DC		1A 25V DC
Rating (min.) (Resistive load)		50μA 3V DC				—
Durability	Operating life without load	10,000 cycles 40mΩ max.			30,000 cycles 40mΩ max.	10,000 cycles 40mΩ max.
	Operating life with load (at max. rated load)	10,000 cycles 40mΩ max.			5,000 cycles 40mΩ max.	
Electrical performance	Initial contact resistance	20mΩ max.				
	Insulation resistance	100MΩ min. 500V DC				
	Voltage proof	500V AC for 1minute				
Mechanical performance	Terminal strength	5N for 1minute				
	Actuator strength	Operating direction	50N	30N	50N	
		Pulling direction	—	—	50N	
Environmental performance	Cold	-40°C 96h	-20°C 96h			
	Dry heat	85°C 96h				
	Damp heat	40°C, 90 to 95%RH 96h				
Page		111	113	115	117	

Push Switches Soldering Conditions	130
Push Switches Cautions	131

### Note

● Indicates applicability to all products in the series.

## Example of Reflow Soldering Condition

1. Heating method: Double heating method with infrared heater.
2. Temperature measurement: Thermocouple  $\phi$  0.1 to 0.2 CA (K) or CC (T) at soldering portion (copper foil surface).  
A heat resisting tape should be used for fixed measurement.
3. Temperature profile



Series (Reflow type)	A (°C) 3s max.	B (°C)	C (s)	D (°C)	E (°C)	F (s)
<b>SPEJ</b>	260	230	40	180	150	120
<b>SPEF</b>						
<b>SPEH</b>						

### Notes

1. The condition mentioned above is the temperature on the mounting surface of a PC board. There are cases where the PC board's temperature greatly differs from that of the switch, depending on the PC board's material, size, thickness, etc.  
The above-stated conditions shall also apply to switch surface temperatures.
2. Soldering conditions differ depending on reflow soldering machines. Prior verification of soldering condition is highly recommended.

## Reference for Hand Soldering

Series	Soldering temperature	Soldering time
<b>SPPJ3, SPPJ2, SPUN, SPPH4, SPPH1</b>	350±10°C	3+1/0s
<b>SPED2, SPED4</b>	350±10°C	3±0.5s
<b>SPEJ</b>	350±10°C	4s max.
<b>SPEF</b>	350±5°C	3s max.
<b>SPEH</b>	350°C max.	3s max.
<b>SPUJ</b>	300±10°C	3+1/0s

## Reference for Dip Soldering

(For PC board terminal types)

Series	Items		Dip soldering	
	Preheating temperature	Preheating time	Soldering temperature	Duration of immersion
<b>SPPJ3</b>	100°C max.	60s max.	260±5°C	5±1s
<b>SPUN</b>	100°C max.	60s max.	260±5°C	10±1s
<b>SPUJ, SPPH4</b>	—		260±5°C	5±1s
<b>SPPJ2, SPPH1, SPED2, SPED4, SPEF</b>	—		260±5°C	10±1s



Компания «ЭлектроПласт» предлагает заключение долгосрочных отношений при поставках импортных электронных компонентов на взаимовыгодных условиях!

Наши преимущества:

- Оперативные поставки широкого спектра электронных компонентов отечественного и импортного производства напрямую от производителей и с крупнейших мировых складов;
- Поставка более 17-ти миллионов наименований электронных компонентов;
- Поставка сложных, дефицитных, либо снятых с производства позиций;
- Оперативные сроки поставки под заказ (от 5 рабочих дней);
- Экспресс доставка в любую точку России;
- Техническая поддержка проекта, помощь в подборе аналогов, поставка прототипов;
- Система менеджмента качества сертифицирована по Международному стандарту ISO 9001;
- Лицензия ФСБ на осуществление работ с использованием сведений, составляющих государственную тайну;
- Поставка специализированных компонентов (Xilinx, Altera, Analog Devices, Intersil, Interpoint, Microsemi, Aeroflex, Peregrine, Syfer, Eurofarad, Texas Instrument, Miteq, Cobham, E2V, MA-COM, Hittite, Mini-Circuits, General Dynamics и др.);

Помимо этого, одним из направлений компании «ЭлектроПласт» является направление «Источники питания». Мы предлагаем Вам помощь Конструкторского отдела:

- Подбор оптимального решения, техническое обоснование при выборе компонента;
- Подбор аналогов;
- Консультации по применению компонента;
- Поставка образцов и прототипов;
- Техническая поддержка проекта;
- Защита от снятия компонента с производства.



#### Как с нами связаться

**Телефон:** 8 (812) 309 58 32 (многоканальный)

**Факс:** 8 (812) 320-02-42

**Электронная почта:** [org@eplast1.ru](mailto:org@eplast1.ru)

**Адрес:** 198099, г. Санкт-Петербург, ул. Калинина, дом 2, корпус 4, литера А.