

Cree® XLamp® XP-G3 LEDs



XP-G3 White



XP-G3 Royal Blue



XP-G3 Photo Red

PRODUCT DESCRIPTION

XLamp® XP-G3 LEDs are optimized for directional, high-lumen lighting applications where efficacy and optical control are critical, such as roadway, portable and horticulture. The compact and proven 3.45-mm XP platform has an excellent ecosystem of optics and system solutions available, enabling lighting manufacturers to simplify their design process and shorten time-to-market.

XP-G3 LEDs are available in royal blue, photo red and two different white versions. White (Standard) delivers best-in-class TM-21 lifetimes and color stability over time. White (S Line) improves on the Standard version: better system-level reliability through switching and dimming cycles, improved resistance to sulfur exposure and higher efficacy. With this S Line version, Cree delivers high-power LED technology that is optimized for robust lighting applications where sensors and the internet-of-things (IOT) are becoming common.

FEATURES

- Available in no CRI minimum white, 70-, 80- and 90-CRI white, royal blue & photo red
- ANSI-compatible chromaticity bins
- 3-step and 5-step options
- White binned at 85 °C, royal blue & photo red binned at 25 °C
- Maximum drive current: white, royal blue: 2000 mA, photo red: 1500 mA
- Low thermal resistance: white: 3 °C/W, royal blue: 2 °C/W, photo red: 2.5 °C/W
- Wide viewing angle: 125°–130°
- Unlimited floor life at ≤ 30 °C/85% RH
- Reflow solderable - JEDEC J-STD-020C
- Electrically neutral thermal path
- RoHS and REACH compliant
- UL® recognized component (E349212)



TABLE OF CONTENTS

Characteristics	3
Flux Characteristics - White (Standard).....	4
Flux Characteristics - White (S Line).....	13
Flux Characteristics - Color	15
Relative Spectral Power Distribution - White (Standard)	16
Relative Spectral Power Distribution - White (S Line)	16
Relative Spectral Power Distribution - Color	17
Relative Flux vs. Junction Temperature - White (Standard)	17
Relative Flux vs. Junction Temperature - White (S Line)	18
Relative Flux vs. Junction Temperature - Color.....	18
Electrical Characteristics - White (Standard)	19
Electrical Characteristics - White (S Line)	19
Electrical Characteristics - Color.....	20
Relative Luminous Flux vs. Current - White (Standard)	20
Relative Luminous Flux vs. Current - White (S Line)	21
Relative Radiant Flux vs. Current - Color	21
Relative Chromaticity vs. Current and Temperature	22
Typical Spatial Distribution - White (Standard)	23
Typical Spatial Distribution - White (S Line)	23
Typical Spatial Distribution - Color.....	24
Thermal Design.....	25
Performance Groups - Luminous Flux.....	26
Performance Groups - Radiant Flux.....	26
Performance Groups - Peak Wavelength.....	27
Performance Groups - Forward Voltage.....	27
Performance Groups - Chromaticity	28
Cree’s Standard Chromaticity Regions Plotted on the 1931 CIE Curve.....	32
Cree’s Standard Cool White Kits Plotted on ANSI Standard Chromaticity Regions.....	34
Cree’s Standard Warm and Neutral White Kits Plotted on ANSI Standard Chromaticity Regions	35
Cree’s EasyWhite® White Kits Plotted on ANSI Standard Chromaticity Regions	36
Cree’s Standard Chromaticity Kits	37
Bin and Order Code Formats.....	38
Reflow Soldering Characteristics.....	39
Notes	40
Mechanical Dimensions	42
Tape and Reel.....	43
Packaging.....	44

CHARACTERISTICS

Characteristics	Unit	Minimum	Typical	Maximum
Thermal resistance, junction to solder point - standard, S Line	°C/W		3	
Thermal resistance, junction to solder point - royal blue	°C/W		2	
Thermal resistance, junction to solder point - photo red	°C/W		2.5	
Viewing angle (FWHM) - standard, S Line	degrees		125	
Viewing angle (FWHM) - royal blue	degrees		130	
Viewing angle (FWHM) - photo red	degrees		125	
Temperature coefficient of voltage	mV/°C		-1.3	
ESD withstand voltage (HBM per Mil-Std-883D)			Class 3A	
DC forward current - standard, S Line, royal blue	mA			2000
DC forward current - photo red	mA			1500
Reverse voltage	V			5
Forward voltage (@ 350 mA, 85 °C) - standard, S Line	V		2.70	2.90
Forward voltage (@ 350 mA, 25 °C) - royal blue	V		2.79	3.0
Forward voltage (@ 350 mA, 25 °C) - photo red	V		1.99	2.2
Forward voltage (@ 700 mA, 85 °C) - standard, S Line	V		2.80	
Forward voltage (@ 700 mA, 25 °C) - royal blue	V		2.90	
Forward voltage (@ 700 mA, 25 °C) - photo red	V		2.18	
Forward voltage (@ 1000 mA, 85 °C) - standard, S Line	V		2.87	
Forward voltage (@ 1000 mA, 25 °C) - royal blue	V		2.99	
Forward voltage (@ 1000 mA, 25 °C) - photo red	V		2.36	
Forward voltage (@ 1500 mA, 85 °C) - standard, S Line	V		2.97	
Forward voltage (@ 1500 mA, 25 °C) - royal blue	V		3.11	
Forward voltage (@ 1500 mA, 25 °C) - photo red	V		2.65	
Forward voltage (@ 2000 mA, 85 °C) - standard, S Line	V		3.06	
Forward voltage (@ 2000 mA, 25 °C) - royal blue	V		3.20	
LED junction temperature	°C			150

FLUX CHARACTERISTICS - WHITE (STANDARD) - $T_j = 85\text{ }^\circ\text{C}$

The following table provides order codes for XLamp XP-G3 White (Standard) LEDs. For a complete description of the order code nomenclature, please see the Bin and Order Code Formats section (page 38). For definitions of the chromaticity kits, please see the Cree's Standard Chromaticity Kits section (page 37).

Chromaticity		Minimum Luminous Flux (lm) @ 350 mA			Order Codes			
Kit	CCT	Code	Flux (lm) @ 85 °C	Flux (lm) @ 25 °C*	70 CRI Typical	70 CRI Minimum	80 CRI Minimum	90 CRI Minimum
DT	7000 K	S5	172	187		XPGDWT-B1-0000-00MDT		
		S4	164	179	XPGDWT-01-0000-00LDT	XPGDWT-B1-0000-00LDT		
		S3	156	170	XPGDWT-01-0000-00KDT	XPGDWT-B1-0000-00KDT	XPGDWT-H1-0000-00KDT	
		S2	148	161	XPGDWT-01-0000-00JDT	XPGDWT-B1-0000-00JDT	XPGDWT-H1-0000-00JDT	
		R5	139	152			XPGDWT-H1-0000-00HDT	
CB	6500 K	S3	156	170			XPGDWT-H1-0000-00KCB	
		S2	148	161			XPGDWT-H1-0000-00JCB	
		R5	139	152			XPGDWT-H1-0000-00HCB	
E0	>6500 K	S4	164	179	XPGDWT-01-0000-00LE0	XPGDWT-B1-0000-00LE0		
		S3	156	170	XPGDWT-01-0000-00KE0	XPGDWT-B1-0000-00KE0	XPGDWT-H1-0000-00KE0	
		S2	148	161	XPGDWT-01-0000-00JE0	XPGDWT-B1-0000-00JE0	XPGDWT-H1-0000-00JE0	
		R5	139	152			XPGDWT-H1-0000-00HE0	
E1	6500 K	S4	164	179	XPGDWT-01-0000-00LE1	XPGDWT-B1-0000-00LE1		
		S3	156	170	XPGDWT-01-0000-00KE1	XPGDWT-B1-0000-00KE1	XPGDWT-H1-0000-00KE1	
		S2	148	161	XPGDWT-01-0000-00JE1	XPGDWT-B1-0000-00JE1	XPGDWT-H1-0000-00JE1	
		R5	139	152			XPGDWT-H1-0000-00HE1	
DV	6000 K	S5	172	187	XPGDWT-01-0000-00MDV	XPGDWT-B1-0000-00MDV		
		S4	164	179	XPGDWT-01-0000-00LDV	XPGDWT-B1-0000-00LDV		
		S3	156	170	XPGDWT-01-0000-00KDV	XPGDWT-B1-0000-00KDV	XPGDWT-H1-0000-00KDV	
		S2	148	161	XPGDWT-01-0000-00JDV	XPGDWT-B1-0000-00JDV	XPGDWT-H1-0000-00JDV	
		R5	139	152			XPGDWT-H1-0000-00HDV	
		R4	130	142				
		R3	122	133				XPGDWT-U1-0000-00FDV
		R2	114	124				XPGDWT-U1-0000-00EDV

Notes

- Cree maintains a tolerance of $\pm 7\%$ on flux and power measurements, ± 0.005 on chromaticity (CCx, CCy) measurements and a tolerance of ± 2 on CRI measurements. See the Measurements section (page 40).
- Cree XLamp XP-G3 LED order codes specify only a minimum flux bin and not a maximum. Cree may ship reels in flux bins higher than the minimum specified by the order code without advance notice. Shipments will always adhere to the chromaticity bin restrictions specified by the order code.
- * Flux values @ 25 °C are calculated and for reference only.

FLUX CHARACTERISTICS - WHITE (STANDARD) - $T_j = 85\text{ }^\circ\text{C}$ (CONTINUED)

Chromaticity		Minimum Luminous Flux (lm) @ 350 mA			Order Codes			
Kit	CCT	Code	Flux (lm) @ 85 °C	Flux (lm) @ 25 °C*	70 CRI Typical	70 CRI Minimum	80 CRI Minimum	90 CRI Minimum
50	6000 K	S5	172	187	XPGDWT-01-0000-00M50	XPGDWT-B1-0000-00M50		
		S4	164	179	XPGDWT-01-0000-00L50	XPGDWT-B1-0000-00L50		
		S3	156	170	XPGDWT-01-0000-00K50	XPGDWT-B1-0000-00K50	XPGDWT-H1-0000-00K50	
		S2	148	161	XPGDWT-01-0000-00J50	XPGDWT-B1-0000-00J50	XPGDWT-H1-0000-00J50	
		R5	139	152			XPGDWT-H1-0000-00H50	
		R4	130	142				
		R3	122	133				XPGDWT-U1-0000-00F50
		R2	114	124				XPGDWT-U1-0000-00E50
E2	5700 K	S5	172	187	XPGDWT-01-0000-00ME2	XPGDWT-B1-0000-00ME2		
		S4	164	179	XPGDWT-01-0000-00LE2	XPGDWT-B1-0000-00LE2		
		S3	156	170	XPGDWT-01-0000-00KE2	XPGDWT-B1-0000-00KE2	XPGDWT-H1-0000-00KE2	
		S2	148	161	XPGDWT-01-0000-00JE2	XPGDWT-B1-0000-00JE2	XPGDWT-H1-0000-00JE2	
		R5	139	152			XPGDWT-H1-0000-00HE2	
		R4	130	142				
		R3	122	133				XPGDWT-U1-0000-00FE2
		R2	114	124				XPGDWT-U1-0000-00EE2
2E	5700 K	S5	172	187		XPGDWT-B1-0000-00M2E		
		S4	164	179		XPGDWT-B1-0000-00L2E		
		S3	156	170		XPGDWT-B1-0000-00K2E	XPGDWT-H1-0000-00K2E	
		S2	148	161		XPGDWT-B1-0000-00J2E	XPGDWT-H1-0000-00J2E	
		R5	139	152			XPGDWT-H1-0000-00H2E	
		R4	130	142				
		R3	122	133				XPGDWT-U1-0000-00F2E
		R2	114	124				XPGDWT-U1-0000-00E2E

Notes

- Cree maintains a tolerance of $\pm 7\%$ on flux and power measurements, ± 0.005 on chromaticity (CCx, CCy) measurements and a tolerance of ± 2 on CRI measurements. See the Measurements section (page 40).
- Cree XLamp XP-G3 LED order codes specify only a minimum flux bin and not a maximum. Cree may ship reels in flux bins higher than the minimum specified by the order code without advance notice. Shipments will always adhere to the chromaticity bin restrictions specified by the order code.
- * Flux values @ 25 °C are calculated and for reference only.

FLUX CHARACTERISTICS - WHITE (STANDARD) - $T_j = 85\text{ }^\circ\text{C}$ (CONTINUED)

Chromaticity		Minimum Luminous Flux (lm) @ 350 mA			Order Codes			
Kit	CCT	Code	Flux (lm) @ 85 °C	Flux (lm) @ 25 °C*	70 CRI Typical	70 CRI Minimum	80 CRI Minimum	90 CRI Minimum
3E	5000 K	S5	172	187		XPGDWT-B1-0000-00M3E		
		S4	164	179		XPGDWT-B1-0000-00L3E		
		S3	156	170		XPGDWT-B1-0000-00K3E	XPGDWT-H1-0000-00K3E	
		S2	148	161		XPGDWT-B1-0000-00J3E	XPGDWT-H1-0000-00J3E	
		R5	139	152			XPGDWT-H1-0000-00H3E	
		R4	130	142				
		R3	122	133				XPGDWT-U1-0000-00F3E
		R2	114	124				XPGDWT-U1-0000-00E3E
E3	5000 K	S5	172	187	XPGDWT-01-0000-00ME3	XPGDWT-B1-0000-00ME3		
		S4	164	179	XPGDWT-01-0000-00LE3	XPGDWT-B1-0000-00LE3		
		S3	156	170	XPGDWT-01-0000-00KE3	XPGDWT-B1-0000-00KE3	XPGDWT-H1-0000-00KE3	
		S2	148	161	XPGDWT-01-0000-00JE3	XPGDWT-B1-0000-00JE3	XPGDWT-H1-0000-00JE3	
		R5	139	152			XPGDWT-H1-0000-00HE3	
		R4	130	142				
		R3	122	133				XPGDWT-U1-0000-00FE3
		R2	114	124				XPGDWT-U1-0000-00EE3
F4	4750K	S5	172	187		XPGDWT-B1-0000-00MF4		
		S4	164	179	XPGDWT-01-0000-00LF4	XPGDWT-B1-0000-00LF4		
		S3	156	170	XPGDWT-01-0000-00KF4	XPGDWT-B1-0000-00KF4	XPGDWT-H1-0000-00KF4	
		S2	148	161	XPGDWT-01-0000-00JF4	XPGDWT-B1-0000-00JF4	XPGDWT-H1-0000-00JF4	
		R5	139	152		XPGDWT-B1-0000-00HF4	XPGDWT-H1-0000-00HF4	
		R4	130	142			XPGDWT-H1-0000-00GF4	
		R3	122	133				XPGDWT-U1-0000-00FF4
		R2	114	124				XPGDWT-U1-0000-00EF4

Notes

- Cree maintains a tolerance of $\pm 7\%$ on flux and power measurements, ± 0.005 on chromaticity (CCx, CCy) measurements and a tolerance of ± 2 on CRI measurements. See the Measurements section (page 40).
- Cree XLamp XP-G3 LED order codes specify only a minimum flux bin and not a maximum. Cree may ship reels in flux bins higher than the minimum specified by the order code without advance notice. Shipments will always adhere to the chromaticity bin restrictions specified by the order code.
- * Flux values @ 25 °C are calculated and for reference only.

FLUX CHARACTERISTICS - WHITE (STANDARD) - $T_j = 85\text{ }^\circ\text{C}$ (CONTINUED)

Chromaticity		Minimum Luminous Flux (lm) @ 350 mA			Order Codes			
Kit	CCT	Code	Flux (lm) @ 85 °C	Flux (lm) @ 25 °C*	70 CRI Typical	70 CRI Minimum	80 CRI Minimum	90 CRI Minimum
4E	4500K	S5	172	187		XPGDWT-B1-0000-00M4E		
		S4	164	179		XPGDWT-B1-0000-00L4E		
		S3	156	170		XPGDWT-B1-0000-00K4E	XPGDWT-H1-0000-00K4E	
		S2	148	161		XPGDWT-B1-0000-00J4E	XPGDWT-H1-0000-00J4E	
		R5	139	152			XPGDWT-H1-0000-00H4E	
		R4	130	142			XPGDWT-H1-0000-00G4E	
		R3	122	133				XPGDWT-U1-0000-00F4E
		R2	114	124				XPGDWT-U1-0000-00E4E
		Q5	107	117				XPGDWT-U1-0000-00D4E
E4	4500 K	S5	172	187		XPGDWT-B1-0000-00ME4		
		S4	164	179	XPGDWT-01-0000-00LE4	XPGDWT-B1-0000-00LE4		
		S3	156	170	XPGDWT-01-0000-00KE4	XPGDWT-B1-0000-00KE4	XPGDWT-H1-0000-00KE4	
		S2	148	161	XPGDWT-01-0000-00JE4	XPGDWT-B1-0000-00JE4	XPGDWT-H1-0000-00JE4	
		R5	139	152		XPGDWT-B1-0000-00HE4	XPGDWT-H1-0000-00HE4	
		R4	130	142			XPGDWT-H1-0000-00GE4	
		R3	122	133				XPGDWT-U1-0000-00FE4
		R2	114	124				XPGDWT-U1-0000-00EE4
		Q5	107	117				XPGDWT-U1-0000-00DE4
F5	4200 K	S5	172	187		XPGDWT-B1-0000-00MF5		
		S4	164	179	XPGDWT-01-0000-00LF5	XPGDWT-B1-0000-00LF5		
		S3	156	170	XPGDWT-01-0000-00KF5	XPGDWT-B1-0000-00KF5		
		S2	148	161	XPGDWT-01-0000-00JF5	XPGDWT-B1-0000-00JF5	XPGDWT-H1-0000-00JF5	
		R5	139	152		XPGDWT-B1-0000-00HF5	XPGDWT-H1-0000-00HF5	
		R4	130	142			XPGDWT-H1-0000-00GF5	
		R3	122	133				XPGDWT-U1-0000-00FF5
		R2	114	124				XPGDWT-U1-0000-00EF5
		Q5	107	117				XPGDWT-U1-0000-00DF5

Notes

- Cree maintains a tolerance of $\pm 7\%$ on flux and power measurements, ± 0.005 on chromaticity (CCx, CCy) measurements and a tolerance of ± 2 on CRI measurements. See the Measurements section (page 40).
- Cree XLamp XP-G3 LED order codes specify only a minimum flux bin and not a maximum. Cree may ship reels in flux bins higher than the minimum specified by the order code without advance notice. Shipments will always adhere to the chromaticity bin restrictions specified by the order code.
- * Flux values @ 25 °C are calculated and for reference only.

FLUX CHARACTERISTICS - WHITE (STANDARD) - $T_j = 85\text{ }^\circ\text{C}$ (CONTINUED)

Chromaticity		Minimum Luminous Flux (lm) @ 350 mA			Order Codes			
Kit	CCT	Code	Flux (lm) @ 85 °C	Flux (lm) @ 25 °C*	70 CRI Typical	70 CRI Minimum	80 CRI Minimum	90 CRI Minimum
5E	4000 K	S5	172	187		XPGDWT-B1-0000-00M5E		
		S4	164	179		XPGDWT-B1-0000-00L5E		
		S3	156	170		XPGDWT-B1-0000-00K5E		
		S2	148	161		XPGDWT-B1-0000-00J5E	XPGDWT-H1-0000-00J5E	
		R5	139	152			XPGDWT-H1-0000-00H5E	
		R4	130	142			XPGDWT-H1-0000-00G5E	
		R3	122	133				XPGDWT-U1-0000-00F5E
		R2	114	124				XPGDWT-U1-0000-00E5E
		Q5	107	117				XPGDWT-U1-0000-00D5E
E5	4000 K	S5	172	187		XPGDWT-B1-0000-00ME5		
		S4	164	179	XPGDWT-01-0000-00LE5	XPGDWT-B1-0000-00LE5		
		S3	156	170	XPGDWT-01-0000-00KE5	XPGDWT-B1-0000-00KE5		
		S2	148	161	XPGDWT-01-0000-00JE5	XPGDWT-B1-0000-00JE5	XPGDWT-H1-0000-00JE5	
		R5	139	152		XPGDWT-B1-0000-00HE5	XPGDWT-H1-0000-00HE5	
		R4	130	142			XPGDWT-H1-0000-00GE5	
		R3	122	133				XPGDWT-U1-0000-00FE5
		R2	114	124				XPGDWT-U1-0000-00EE5
		Q5	107	117				XPGDWT-U1-0000-00DE5
F6	3700 K	S4	164	179	XPGDWT-01-0000-00LF6	XPGDWT-B1-0000-00LF6		
		S3	156	170	XPGDWT-01-0000-00KF6	XPGDWT-B1-0000-00KF6		
		S2	148	161	XPGDWT-01-0000-00JF6	XPGDWT-B1-0000-00JF6	XPGDWT-H1-0000-00JF6	
		R5	139	152	XPGDWT-01-0000-00HF6	XPGDWT-B1-0000-00HF6	XPGDWT-H1-0000-00HF6	
		R4	130	142			XPGDWT-H1-0000-00GF6	
		R3	122	133				
		R2	114	124				XPGDWT-U1-0000-00EF6
		Q5	107	117				XPGDWT-U1-0000-00DF6
		Q4	100	109				XPGDWT-U1-0000-00CF6

Notes

- Cree maintains a tolerance of $\pm 7\%$ on flux and power measurements, ± 0.005 on chromaticity (CCx, CCy) measurements and a tolerance of ± 2 on CRI measurements. See the Measurements section (page 40).
- Cree XLamp XP-G3 LED order codes specify only a minimum flux bin and not a maximum. Cree may ship reels in flux bins higher than the minimum specified by the order code without advance notice. Shipments will always adhere to the chromaticity bin restrictions specified by the order code.
- * Flux values @ 25 °C are calculated and for reference only.

FLUX CHARACTERISTICS - WHITE (STANDARD) - T_j = 85 °C (CONTINUED)

Chromaticity		Minimum Luminous Flux (lm) @ 350 mA			Order Codes			
Kit	CCT	Code	Flux (lm) @ 85 °C	Flux (lm) @ 25 °C*	70 CRI Typical	70 CRI Minimum	80 CRI Minimum	90 CRI Minimum
6E	3500 K	S4	164	179		XPGDWT-B1-0000-00L6E		
		S3	156	170		XPGDWT-B1-0000-00K6E		
		S2	148	161		XPGDWT-B1-0000-00J6E	XPGDWT-H1-0000-00J6E	
		R5	139	152		XPGDWT-B1-0000-00H6E	XPGDWT-H1-0000-00H6E	
		R4	130	142			XPGDWT-H1-0000-00G6E	
		R3	122	133				
		R2	114	124				XPGDWT-U1-0000-00E6E
		Q5	107	117				XPGDWT-U1-0000-00D6E
		Q4	100	109				XPGDWT-U1-0000-00C6E
6G	3500 K	R2	114	124				XPGDWT-U1-0000-00E6G
		Q5	107	117				XPGDWT-U1-0000-00D6G
		Q4	100	109				XPGDWT-U1-0000-00C6G
E6	3500 K	S4	164	179		XPGDWT-B1-0000-00L6E		
		S3	156	170	XPGDWT-01-0000-00KE6	XPGDWT-B1-0000-00KE6		
		S2	148	161	XPGDWT-01-0000-00JE6	XPGDWT-B1-0000-00JE6	XPGDWT-H1-0000-00JE6	
		R5	139	152	XPGDWT-01-0000-00HE6	XPGDWT-B1-0000-00HE6	XPGDWT-H1-0000-00HE6	
		R4	130	142			XPGDWT-H1-0000-00GE6	
		R3	122	133				
		R2	114	124				XPGDWT-U1-0000-00EE6
		Q5	107	117				XPGDWT-U1-0000-00DE6
		Q4	100	109				XPGDWT-U1-0000-00CE6

Notes

- Cree maintains a tolerance of ±7% on flux and power measurements, ±0.005 on chromaticity (CCx, CCy) measurements and a tolerance of ±2 on CRI measurements. See the Measurements section (page 40).
- Cree XLamp XP-G3 LED order codes specify only a minimum flux bin and not a maximum. Cree may ship reels in flux bins higher than the minimum specified by the order code without advance notice. Shipments will always adhere to the chromaticity bin restrictions specified by the order code.
- * Flux values @ 25 °C are calculated and for reference only.

FLUX CHARACTERISTICS - WHITE (STANDARD) - $T_j = 85\text{ }^\circ\text{C}$ (CONTINUED)

Chromaticity		Minimum Luminous Flux (lm) @ 350 mA			Order Codes			
Kit	CCT	Code	Flux (lm) @ 85 °C	Flux (lm) @ 25 °C*	70 CRI Typical	70 CRI Minimum	80 CRI Minimum	90 CRI Minimum
F7	3200K	S4	164	179		XPGDWT-B1-0000-00LF7		
		S3	156	170	XPGDWT-01-0000-00KF7	XPGDWT-B1-0000-00KF7		
		S2	148	161	XPGDWT-01-0000-00JF7	XPGDWT-B1-0000-00JF7		
		R5	139	152	XPGDWT-01-0000-00HF7	XPGDWT-B1-0000-00HF7	XPGDWT-H1-0000-00HF7	
		R4	130	142			XPGDWT-H1-0000-00GF7	
		R3	122	133				
		R2	114	124				XPGDWT-U1-0000-00EF7
		Q5	107	117				XPGDWT-U1-0000-00DF7
		Q4	100	109				XPGDWT-U1-0000-00CF7
7E	3000 K	S4	164	179		XPGDWT-B1-0000-00L7E		
		S3	156	170		XPGDWT-B1-0000-00K7E		
		S2	148	161		XPGDWT-B1-0000-00J7E		
		R5	139	152		XPGDWT-B1-0000-00H7E	XPGDWT-H1-0000-00H7E	
		R4	130	142			XPGDWT-H1-0000-00G7E	
		R3	122	133				
		R2	114	124				XPGDWT-U1-0000-00E7E
		Q5	107	117				XPGDWT-U1-0000-00D7E
		Q4	100	109				XPGDWT-U1-0000-00C7E
7G	3000 K	R2	114	124				XPGDWT-U1-0000-00E7G
		Q5	107	117				XPGDWT-U1-0000-00D7G
		Q4	100	109				XPGDWT-U1-0000-00C7G

Notes

- Cree maintains a tolerance of $\pm 7\%$ on flux and power measurements, ± 0.005 on chromaticity (CCx, CCy) measurements and a tolerance of ± 2 on CRI measurements. See the Measurements section (page 40).
- Cree XLamp XP-G3 LED order codes specify only a minimum flux bin and not a maximum. Cree may ship reels in flux bins higher than the minimum specified by the order code without advance notice. Shipments will always adhere to the chromaticity bin restrictions specified by the order code.
- * Flux values @ 25 °C are calculated and for reference only.

FLUX CHARACTERISTICS - WHITE (STANDARD) - $T_j = 85\text{ }^\circ\text{C}$ (CONTINUED)

Chromaticity		Minimum Luminous Flux (lm) @ 350 mA			Order Codes			
Kit	CCT	Code	Flux (lm) @ 85 °C	Flux (lm) @ 25 °C*	70 CRI Typical	70 CRI Minimum	80 CRI Minimum	90 CRI Minimum
E7	3000 K	S4	164	179		XPGDWT-B1-0000-00LE7		
		S3	156	170	XPGDWT-01-0000-00KE7	XPGDWT-B1-0000-00KE7		
		S2	148	161	XPGDWT-01-0000-00JE7	XPGDWT-B1-0000-00JE7		
		R5	139	152	XPGDWT-01-0000-00HE7	XPGDWT-B1-0000-00HE7	XPGDWT-H1-0000-00HE7	
		R4	130	142			XPGDWT-H1-0000-00GE7	
		R3	122	133				
		R2	114	124				XPGDWT-U1-0000-00EE7
		Q5	107	117				XPGDWT-U1-0000-00DE7
		Q4	100	109				
F8	2850 K	R5	139	152			XPGDWT-H1-0000-00HF8	
		R4	130	142			XPGDWT-H1-0000-00GF8	
		R3	122	133			XPGDWT-H1-0000-00FF8	
		R2	114	124				XPGDWT-U1-0000-00EF8
		Q5	107	117				XPGDWT-U1-0000-00DF8
		Q4	100	109				XPGDWT-U1-0000-00CF8
8E	2700 K	S4	164	179		XPGDWT-B1-0000-00L8E		
		S3	156	170		XPGDWT-B1-0000-00K8E		
		S2	148	161		XPGDWT-B1-0000-00J8E		
		R5	139	152			XPGDWT-H1-0000-00H8E	
		R4	130	142			XPGDWT-H1-0000-00G8E	
		R3	122	133			XPGDWT-H1-0000-00F8E	
		R2	114	124				XPGDWT-U1-0000-00E8E
		Q5	107	117				XPGDWT-U1-0000-00D8E
		Q4	100	109				XPGDWT-U1-0000-00C8E
8G	2700 K	R2	114	124				XPGDWT-U1-0000-00E8G
		Q5	107	117				XPGDWT-U1-0000-00D8G
		Q4	100	109				XPGDWT-U1-0000-00C8G

Notes

- Cree maintains a tolerance of $\pm 7\%$ on flux and power measurements, ± 0.005 on chromaticity (CCx, CCy) measurements and a tolerance of ± 2 on CRI measurements. See the Measurements section (page 40).
- Cree XLamp XP-G3 LED order codes specify only a minimum flux bin and not a maximum. Cree may ship reels in flux bins higher than the minimum specified by the order code without advance notice. Shipments will always adhere to the chromaticity bin restrictions specified by the order code.
- * Flux values @ 25 °C are calculated and for reference only.

FLUX CHARACTERISTICS - WHITE (STANDARD) - $T_j = 85\text{ }^\circ\text{C}$ (CONTINUED)

Chromaticity		Minimum Luminous Flux (lm) @ 350 mA			Order Codes			
Kit	CCT	Code	Flux (lm) @ 85 °C	Flux (lm) @ 25 °C*	70 CRI Typical	70 CRI Minimum	80 CRI Minimum	90 CRI Minimum
E8	2700K	S4	164	179		XPGDWT-B1-0000-00LE8		
		S3	156	170		XPGDWT-B1-0000-00KE8		
		S2	148	161		XPGDWT-B1-0000-00JE8		
		R5	139	152			XPGDWT-H1-0000-00HE8	
		R4	130	142			XPGDWT-H1-0000-00GE8	
		R3	122	133			XPGDWT-H1-0000-00FE8	
		R2	114	124				XPGDWT-U1-0000-00EE8
		Q5	107	117				XPGDWT-U1-0000-00DE8
		Q4	100	109				
EA	2200 K	R3	122	133		XPGDWT-B1-0000-00FEA		
		R2	114	124		XPGDWT-B1-0000-00EEA		

Notes

- Cree maintains a tolerance of $\pm 7\%$ on flux and power measurements, ± 0.005 on chromaticity (CCx, CCy) measurements and a tolerance of ± 2 on CRI measurements. See the Measurements section (page 40).
- Cree XLamp XP-G3 LED order codes specify only a minimum flux bin and not a maximum. Cree may ship reels in flux bins higher than the minimum specified by the order code without advance notice. Shipments will always adhere to the chromaticity bin restrictions specified by the order code.
- * Flux values @ 25 °C are calculated and for reference only.

FLUX CHARACTERISTICS - WHITE (S LINE) - $T_j = 85\text{ }^\circ\text{C}$

The following table provides order codes for XLamp XP-G3 White (S Line) LEDs. For a complete description of the order code nomenclature, please see the Bin and Order Code Formats section (page 38). For definitions of the chromaticity kits, please see the Cree's Standard Chromaticity Kits section (page 37).

Chromaticity		Minimum Luminous Flux (lm) @ 350 mA			Order Codes
Kit	CCT	Code	Flux (lm) @ 85 °C	Flux (lm) @ 25 °C*	70 CRI Minimum
E1	6500 K	S4	164	179	XPGDWT-BS-0000-00LE1
		S3	156	170	XPGDWT-BS-0000-00KE1
DV	6000 K	S5	172	187	XPGDWT-BS-0000-00MDV
		S4	164	179	XPGDWT-BS-0000-00LDV
		S3	156	170	XPGDWT-BS-0000-00KDV
50	6000 K	S4	164	179	XPGDWT-BS-0000-00L50
		S3	156	170	XPGDWT-BS-0000-00K50
E2	5700 K	S5	172	187	XPGDWT-BS-0000-00ME2
		S4	164	179	XPGDWT-BS-0000-00LE2
		S3	156	170	XPGDWT-BS-0000-00KE2
2E	5700 K	S5	172	187	XPGDWT-BS-0000-00M2E
		S4	164	179	XPGDWT-BS-0000-00L2E
		S3	156	170	XPGDWT-BS-0000-00K2E
3E	5000 K	S6	180	196	XPGDWT-BS-0000-00N3E
		S5	172	187	XPGDWT-BS-0000-00M3E
		S4	164	179	XPGDWT-BS-0000-00L3E
E3	5000 K	S6	180	196	XPGDWT-BS-0000-00NE3
		S5	172	187	XPGDWT-BS-0000-00ME3
		S4	164	179	XPGDWT-BS-0000-00LE3
4E	4500K	S6	180	196	XPGDWT-BS-0000-00N4E
		S5	172	187	XPGDWT-BS-0000-00M4E
		S4	164	179	XPGDWT-BS-0000-00L4E
E4	4500 K	S6	180	196	XPGDWT-BS-0000-00NE4
		S5	172	187	XPGDWT-BS-0000-00ME4
		S4	164	179	XPGDWT-BS-0000-00LE4

Notes

- Cree maintains a tolerance of $\pm 7\%$ on flux and power measurements, ± 0.005 on chromaticity (CCx, CCy) measurements and a tolerance of ± 2 on CRI measurements. See the Measurements section (page 40).
- Cree XLamp XP-G3 LED order codes specify only a minimum flux bin and not a maximum. Cree may ship reels in flux bins higher than the minimum specified by the order code without advance notice. Shipments will always adhere to the chromaticity bin restrictions specified by the order code.
- * Flux values @ 25 °C are calculated and for reference only.

FLUX CHARACTERISTICS - WHITE (S LINE) - $T_j = 85\text{ }^\circ\text{C}$ (CONTINUED)

Chromaticity		Minimum Luminous Flux (lm) @ 350 mA			Order Codes
Kit	CCT	Code	Flux (lm) @ 85 °C	Flux (lm) @ 25 °C*	70 CRI Minimum
5E	4000 K	S6	180	196	XPGDWT-BS-0000-00N5E
		S5	172	187	XPGDWT-BS-0000-00M5E
		S4	164	179	XPGDWT-BS-0000-00L5E
E5	4000 K	S6	180	196	XPGDWT-BS-0000-00NE5
		S5	172	187	XPGDWT-BS-0000-00ME5
		S4	164	179	XPGDWT-BS-0000-00LE5
6E	3500 K	S4	164	179	XPGDWT-BS-0000-00L6E
		S3	156	170	XPGDWT-BS-0000-00K6E
		S2	148	161	XPGDWT-BS-0000-00J6E
E6	3500 K	S4	164	179	XPGDWT-BS-0000-00LE6
		S3	156	170	XPGDWT-BS-0000-00KE6
		S2	148	161	XPGDWT-BS-0000-00JE6
F7	3200K	S4	164	179	XPGDWT-BS-0000-00LF7
		S3	156	170	XPGDWT-BS-0000-00KF7
		S2	148	161	XPGDWT-BS-0000-00JF7
7E	3000 K	S4	164	179	XPGDWT-BS-0000-00L7E
		S3	156	170	XPGDWT-BS-0000-00K7E
		S2	148	161	XPGDWT-BS-0000-00J7E
E7	3000 K	S4	164	179	XPGDWT-BS-0000-00LE7
		S3	156	170	XPGDWT-BS-0000-00KE7
		S2	148	161	XPGDWT-BS-0000-00JE7

Notes

- Cree maintains a tolerance of $\pm 7\%$ on flux and power measurements, ± 0.005 on chromaticity (CCx, CCy) measurements and a tolerance of ± 2 on CRI measurements. See the Measurements section (page 40).
- Cree XLamp XP-G3 LED order codes specify only a minimum flux bin and not a maximum. Cree may ship reels in flux bins higher than the minimum specified by the order code without advance notice. Shipments will always adhere to the chromaticity bin restrictions specified by the order code.
- * Flux values @ 25 °C are calculated and for reference only.

FLUX CHARACTERISTICS - COLOR ($T_j = 25\text{ }^\circ\text{C}$)

The following table provides the order code for XLamp XP-G3 color LEDs. For a complete description of the order code nomenclature, please see the Bin and Order Code Formats section (page 38).

	PWL Kit Code	Peak Wavelength Range				Typical Dominant Wavelength (nm) @ 350 mA, $T_j=25\text{ }^\circ\text{C}$	Minimum Radiant Flux (mW) @ 350 mA,		Calculated Minimum PPF ($\mu\text{mol/s}$) @ 350 mA, $25\text{ }^\circ\text{C}$	Order Code
		Minimum		Maximum			Code	Flux (mW) @25 $^\circ\text{C}$		
		Group	PWL (nm)	Group	PWL (nm)					
Royal Blue	01	H26	440	H47	455	451	E4	635	2.41	XPGDRY-L1-0000-00401
						451	F2	680	2.58	XPGDRY-L1-0000-00501
						451	F4	730	2.77	XPGDRY-L1-0000-00601

	PWL Kit Code	Peak Wavelength Range				Typical Dominant Wavelength (nm) @ 350 mA, $T_j=25\text{ }^\circ\text{C}$	Minimum Radiant Flux (mW) @ 350 mA,		Calculated Minimum PPF ($\mu\text{mol/s}$) @ 350 mA, $25\text{ }^\circ\text{C}$	Order Code
		Minimum		Maximum			Code	Flux (mW) @25 $^\circ\text{C}$		
		Group	PWL (nm)	Group	PWL (nm)					
Photo Red	01	P2	650	P5	670	645	31	475	2.61	XPGDPR-L1-0000-00E01
		P2	650	P5	670	645	32	500	2.75	XPGDPR-L1-0000-00F01
		P2	650	P5	670	645	33	525	2.88	XPGDPR-L1-0000-00G01

Notes

- Cree maintains a tolerance of $\pm 7\%$ on flux and power measurements, ± 0.005 on chromaticity (CCx, CCy) measurements and a tolerance of ± 2 on CRI measurements. See the Measurements section (page 40).
- Cree XLamp XP-G3 LED order codes specify only a minimum flux bin and not a maximum. Cree may ship reels in flux bins higher than the minimum specified by the order code without advance notice. Shipments will always adhere to the chromaticity bin restrictions specified by the order code.
- Dominant wavelengths are calculated based on peak wavelength specifications and are for reference only.
- Calculated Photosynthetic Photon Flux (PPF) values are for reference only.

RELATIVE SPECTRAL POWER DISTRIBUTION - WHITE (STANDARD)



RELATIVE SPECTRAL POWER DISTRIBUTION - WHITE (S LINE)



RELATIVE SPECTRAL POWER DISTRIBUTION - COLOR



RELATIVE FLUX VS. JUNCTION TEMPERATURE - WHITE (STANDARD) - $I_F = 350$ mA



RELATIVE FLUX VS. JUNCTION TEMPERATURE - WHITE (S LINE) - $I_F = 350$ mA



RELATIVE FLUX VS. JUNCTION TEMPERATURE - COLOR - $I_F = 350$ mA



ELECTRICAL CHARACTERISTICS - WHITE (STANDARD) - $T_j = 85\text{ }^\circ\text{C}$



ELECTRICAL CHARACTERISTICS - WHITE (S LINE) - $T_j = 85\text{ }^\circ\text{C}$



ELECTRICAL CHARACTERISTICS - COLOR ($T_j = 25\text{ }^\circ\text{C}$)

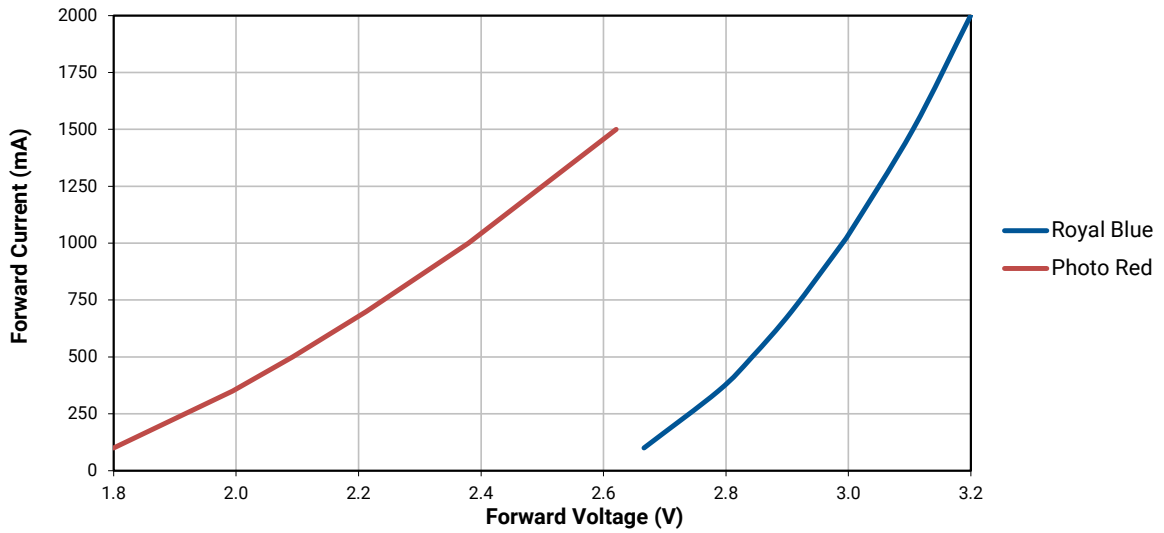

RELATIVE LUMINOUS FLUX VS. CURRENT - WHITE (STANDARD) - $T_j = 85\text{ }^\circ\text{C}$



RELATIVE LUMINOUS FLUX VS. CURRENT - WHITE (S LINE) - $T_j = 85\text{ }^\circ\text{C}$



RELATIVE RADIANT FLUX VS. CURRENT - COLOR ($T_j = 25\text{ }^\circ\text{C}$)



RELATIVE CHROMATICITY VS. CURRENT AND TEMPERATURE

Data shown is representative of typical XP-G3 70 CRI performance.

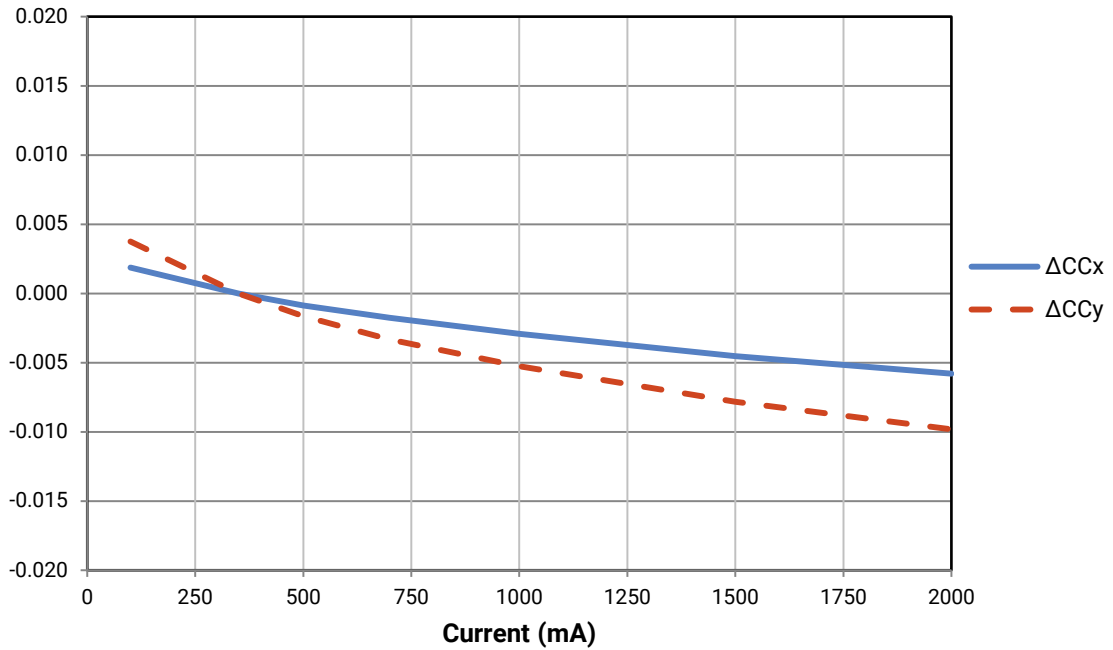

TYPICAL SPATIAL DISTRIBUTION - WHITE (STANDARD)



TYPICAL SPATIAL DISTRIBUTION - WHITE (S LINE)



TYPICAL SPATIAL DISTRIBUTION - COLOR



THERMAL DESIGN

The maximum forward current is determined by the thermal resistance between the LED junction and ambient. It is crucial for the end product to be designed in a manner that minimizes the thermal resistance from the solder point to ambient in order to optimize lamp life and optical characteristics.

White (Standard)



White (S Line)



Royal Blue



Photo Red



PERFORMANCE GROUPS - LUMINOUS FLUX

XLamp XP-G3 white (Standard) and XP-G3 white (S Line) LEDs are tested for luminous flux and placed into one of the following luminous-flux groups.

Group Code	Minimum Luminous Flux (lm) @ 350 mA	Maximum Luminous Flux (lm) @ 350 mA
Q4	100	107
Q5	107	114
R2	114	122
R3	122	130
R4	130	139
R5	139	148
S2	148	156
S3	156	164
S4	164	172
S5	172	180
S6	180	188
S7	188	196

PERFORMANCE GROUPS - RADIANT FLUX (T_j = 25 °C)

XLamp XP-G3 royal blue LEDs are tested for radiant flux and placed into one of the following bins.

Group Code	Minimum Radiant Flux (mW)	Maximum Radiant Flux (mW)	Calculated PPF (μmol/s)	
			Minimum	Maximum
E4	635	680	2.41	2.58
F2	680	730	2.58	2.77
F4	730	780	2.77	2.96

XLamp XP-G3 photo red LEDs are tested for radiant flux and placed into one of the following bins.

Group Code	Minimum Radiant Flux (mW)	Maximum Radiant Flux (mW)	Calculated PPF (μmol/s)	
			Minimum	Maximum
31	475	500	2.60	2.74
32	500	525	2.74	2.90
33	525	550	2.90	3.03

Note

- Calculated PPF values are for reference only.

PERFORMANCE GROUPS - PEAK WAVELENGTH ($T_j = 25\text{ }^\circ\text{C}$)

XLamp XP-G3 royal blue LEDs are tested for peak wavelength and sorted into one of the PWL bins defined below.

Group Code	Minimum Peak Wavelength (nm)	Maximum Peak Wavelength (nm)	Typical Dominant Wavelength (nm)
H26	440.0	442.5	446.5
H27	442.5	445.0	449.0
H36	445.0	447.5	451.5
H37	447.5	450.0	454.0
H46	450.0	452.5	456.5
H47	452.5	455.0	459.0

XLamp XP-G3 photo red LEDs are tested for peak wavelength and sorted into one of the PWL bins defined below.

Group Code	Minimum Peak Wavelength (nm)	Maximum Peak Wavelength (nm)	Typical Dominant Wavelength (nm)
P2	650	655	638
P3	655	660	643
P4	660	665	647
P5	665	670	652

Note

- Typical dominant wavelength values are calculated and for reference only.

PERFORMANCE GROUPS - FORWARD VOLTAGE

XLamp XP-G3 photo red LEDs are tested for forward voltage and sorted into one of the forward voltage bins defined below.

Forward Voltage Group	Minimum Forward Voltage (V) @ 350 mA	Maximum Forward Voltage (V) @ 350 mA
W	1.8	1.9
X	1.9	2.0
Y	2.0	2.1
Z	2.1	2.2

PERFORMANCE GROUPS - CHROMATICITY

Region	x	y	Region	x	y	Region	x	y	Region	x	y
0A	0.2950	0.2970	0B	0.2920	0.3060	0C	0.2984	0.3133	0D	0.2984	0.3133
	0.2920	0.3060		0.2895	0.3135		0.2962	0.3220		0.3048	0.3207
	0.2984	0.3133		0.2962	0.3220		0.3028	0.3304		0.3068	0.3113
	0.3009	0.3042		0.2984	0.3133		0.3048	0.3207		0.3009	0.3042
0R	0.2980	0.2880	0S	0.2895	0.3135	0T	0.2962	0.3220	0U	0.3037	0.2937
	0.2950	0.2970		0.2870	0.3210		0.2937	0.3312		0.3009	0.3042
	0.3009	0.3042		0.2937	0.3312		0.3005	0.3415		0.3068	0.3113
	0.3037	0.2937		0.2962	0.3220		0.3028	0.3304		0.3093	0.2993
1A	0.3048	0.3207	1B	0.3028	0.3304	1C	0.3115	0.3391	1D	0.3130	0.3290
	0.3130	0.3290		0.3115	0.3391		0.3205	0.3481		0.3213	0.3373
	0.3144	0.3186		0.3130	0.3290		0.3213	0.3373		0.3221	0.3261
	0.3068	0.3113		0.3048	0.3207		0.3130	0.3290		0.3144	0.3186
1R	0.3068	0.3113	1S	0.3005	0.3415	1T	0.3099	0.3509	1U	0.3144	0.3186
	0.3144	0.3186		0.3099	0.3509		0.3196	0.3602		0.3221	0.3261
	0.3161	0.3059		0.3115	0.3391		0.3205	0.3481		0.3231	0.3120
	0.3093	0.2993		0.3028	0.3304		0.3115	0.3391		0.3161	0.3059
2A	0.3215	0.3350	2B	0.3207	0.3462	2C	0.3290	0.3538	2D	0.3290	0.3417
	0.3290	0.3417		0.3290	0.3538		0.3376	0.3616		0.3371	0.3490
	0.3290	0.3300		0.3290	0.3417		0.3371	0.3490		0.3366	0.3369
	0.3222	0.3243		0.3215	0.3350		0.3290	0.3417		0.3290	0.3300
2R	0.3222	0.3243	2S	0.3196	0.3602	2T	0.3290	0.3690	2U	0.3290	0.3300
	0.3290	0.3300		0.3290	0.3690		0.3381	0.3762		0.3366	0.3369
	0.3290	0.3180		0.3290	0.3538		0.3376	0.3616		0.3361	0.3245
	0.3231	0.3120		0.3207	0.3462		0.3290	0.3538		0.3290	0.3180
3A	0.3371	0.3490	3B	0.3376	0.3616	3C	0.3463	0.3687	3D	0.3451	0.3554
	0.3451	0.3554		0.3463	0.3687		0.3551	0.3760		0.3533	0.3620
	0.3440	0.3427		0.3451	0.3554		0.3533	0.3620		0.3515	0.3487
	0.3366	0.3369		0.3371	0.3490		0.3451	0.3554		0.3440	0.3427
3R	0.3366	0.3369	3S	0.3381	0.3762						
	0.3440	0.3428		0.3480	0.3840						
	0.3429	0.3307		0.3463	0.3687						
	0.3361	0.3245		0.3376	0.3616						
4A	0.3530	0.3597	4B	0.3548	0.3736	4C	0.3641	0.3804	4D	0.3615	0.3659
	0.3615	0.3659		0.3641	0.3804		0.3736	0.3874		0.3702	0.3722
	0.3590	0.3521		0.3615	0.3659		0.3702	0.3722		0.3670	0.3578
	0.3512	0.3465		0.3530	0.3597		0.3615	0.3659		0.3590	0.3521

PERFORMANCE GROUPS - CHROMATICITY (CONTINUED)

Region	x	y	Region	x	y	Region	x	y	Region	x	y
5A1	0.3670	0.3578	5A2	0.3686	0.3649	5A3	0.3744	0.3685	5A4	0.3726	0.3612
	0.3686	0.3649		0.3702	0.3722		0.3763	0.3760		0.3744	0.3685
	0.3744	0.3685		0.3763	0.3760		0.3825	0.3798		0.3804	0.3721
	0.3726	0.3612		0.3744	0.3685		0.3804	0.3721		0.3783	0.3646
5B1	0.3702	0.3722	5B2	0.3719	0.3797	5B3	0.3782	0.3837	5B4	0.3763	0.3760
	0.3719	0.3797		0.3736	0.3874		0.3802	0.3916		0.3782	0.3837
	0.3782	0.3837		0.3802	0.3916		0.3869	0.3958		0.3847	0.3877
	0.3763	0.3760		0.3782	0.3837		0.3847	0.3877		0.3825	0.3798
5C1	0.3825	0.3798	5C2	0.3847	0.3877	5C3	0.3912	0.3917	5C4	0.3887	0.3836
	0.3847	0.3877		0.3869	0.3958		0.3937	0.4001		0.3912	0.3917
	0.3912	0.3917		0.3937	0.4001		0.4006	0.4044		0.3978	0.3958
	0.3887	0.3836		0.3912	0.3917		0.3978	0.3958		0.3950	0.3875
5D1	0.3783	0.3646	5D2	0.3804	0.3721	5D3	0.3863	0.3758	5D4	0.3840	0.3681
	0.3804	0.3721		0.3825	0.3798		0.3887	0.3836		0.3863	0.3758
	0.3863	0.3758		0.3887	0.3836		0.3950	0.3875		0.3924	0.3794
	0.3840	0.3681		0.3863	0.3758		0.3924	0.3794		0.3898	0.3716
6A1	0.3889	0.3690	6A2	0.3915	0.3768	6A3	0.3981	0.3800	6A4	0.3953	0.3720
	0.3915	0.3768		0.3941	0.3848		0.4010	0.3882		0.3981	0.3800
	0.3981	0.3800		0.4010	0.3882		0.4080	0.3916		0.4048	0.3832
	0.3953	0.3720		0.3981	0.3800		0.4048	0.3832		0.4017	0.3751
6B1	0.3941	0.3848	6B2	0.3968	0.3930	6B3	0.4040	0.3966	6B4	0.4010	0.3882
	0.3968	0.3930		0.3996	0.4015		0.4071	0.4052		0.4040	0.3966
	0.4040	0.3966		0.4071	0.4052		0.4146	0.4089		0.4113	0.4001
	0.4010	0.3882		0.4040	0.3966		0.4113	0.4001		0.4080	0.3916
6C1	0.4080	0.3916	6C2	0.4113	0.4001	6C3	0.4186	0.4037	6C4	0.4150	0.3950
	0.4113	0.4001		0.4146	0.4089		0.4222	0.4127		0.4186	0.4037
	0.4186	0.4037		0.4222	0.4127		0.4299	0.4165		0.4259	0.4073
	0.4150	0.3950		0.4186	0.4037		0.4259	0.4073		0.4221	0.3984
6D1	0.4017	0.3751	6D2	0.4048	0.3832	6D3	0.4116	0.3865	6D4	0.4082	0.3782
	0.4048	0.3832		0.4080	0.3916		0.4150	0.3950		0.4116	0.3865
	0.4116	0.3865		0.4150	0.3950		0.4221	0.3984		0.4183	0.3898
	0.4082	0.3782		0.4116	0.3865		0.4183	0.3898		0.4147	0.3814
7A1	0.4147	0.3814	7A2	0.4183	0.3898	7A3	0.4242	0.3919	7A4	0.4203	0.3833
	0.4183	0.3898		0.4221	0.3984		0.4281	0.4006		0.4242	0.3919
	0.4242	0.3919		0.4281	0.4006		0.4342	0.4028		0.4300	0.3939
	0.4203	0.3833		0.4242	0.3919		0.4300	0.3939		0.4259	0.3853

PERFORMANCE GROUPS - CHROMATICITY (CONTINUED)

Region	x	y	Region	x	y	Region	x	y	Region	x	y
7B1	0.4221	0.3984	7B2	0.4259	0.4073	7B3	0.4322	0.4096	7B4	0.4281	0.4006
	0.4259	0.4073		0.4299	0.4165		0.4364	0.4188		0.4322	0.4096
	0.4322	0.4096		0.4364	0.4188		0.4430	0.4212		0.4385	0.4119
	0.4281	0.4006		0.4322	0.4096		0.4385	0.4119		0.4342	0.4028
7C1	0.4342	0.4028	7C2	0.4385	0.4119	7C3	0.4449	0.4141	7C4	0.4403	0.4049
	0.4385	0.4119		0.4430	0.4212		0.4496	0.4236		0.4449	0.4141
	0.4449	0.4141		0.4496	0.4236		0.4562	0.4260		0.4513	0.4164
	0.4403	0.4049		0.4449	0.4141		0.4513	0.4164		0.4465	0.4071
7D1	0.4259	0.3853	7D2	0.4300	0.3939	7D3	0.4359	0.3960	7D4	0.4316	0.3873
	0.4300	0.3939		0.4342	0.4028		0.4403	0.4049		0.4359	0.3960
	0.4359	0.3960		0.4403	0.4049		0.4465	0.4071		0.4418	0.3981
	0.4316	0.3873		0.4359	0.3960		0.4418	0.3981		0.4373	0.3893
8A1	0.4373	0.3893	8A2	0.4418	0.3981	8A3	0.4475	0.3994	8A4	0.4428	0.3906
	0.4418	0.3981		0.4465	0.4071		0.4523	0.4085		0.4475	0.3994
	0.4475	0.3994		0.4523	0.4085		0.4582	0.4099		0.4532	0.4008
	0.4428	0.3906		0.4475	0.3994		0.4532	0.4008		0.4483	0.3919
8B1	0.4465	0.4071	8B2	0.4513	0.4164	8B3	0.4573	0.4178	8B4	0.4523	0.4085
	0.4513	0.4164		0.4562	0.4260		0.4624	0.4274		0.4573	0.4178
	0.4573	0.4178		0.4624	0.4274		0.4687	0.4289		0.4634	0.4193
	0.4523	0.4085		0.4573	0.4178		0.4634	0.4193		0.4582	0.4099
8C1	0.4582	0.4099	8C2	0.4634	0.4193	8C3	0.4695	0.4207	8C4	0.4641	0.4112
	0.4634	0.4193		0.4687	0.4289		0.4750	0.4304		0.4695	0.4207
	0.4695	0.4207		0.4750	0.4304		0.4813	0.4319		0.4756	0.4221
	0.4641	0.4112		0.4695	0.4207		0.4756	0.4221		0.4700	0.4126
8D1	0.4483	0.3919	8D2	0.4532	0.4008	8D3	0.4589	0.4021	8D4	0.4538	0.3931
	0.4532	0.4008		0.4582	0.4099		0.4641	0.4112		0.4589	0.4021
	0.4589	0.4021		0.4641	0.4112		0.4700	0.4126		0.4646	0.4034
	0.4538	0.3931		0.4589	0.4021		0.4646	0.4034		0.4593	0.3944
AA1	0.4822	0.3973	AA2	0.4884	0.4067	AA3	0.4942	0.4066	AA4	0.4879	0.3972
	0.4884	0.4067		0.4946	0.4162		0.5006	0.4160		0.4942	0.4066
	0.4942	0.4066		0.5006	0.4160		0.5066	0.4158		0.5001	0.4064
	0.4879	0.3972		0.4942	0.4066		0.5001	0.4064		0.4936	0.3970
AB1	0.4946	0.4162	AB2	0.5008	0.4256	AB3	0.5069	0.4254	AB4	0.5006	0.4160
	0.5008	0.4256		0.5070	0.4350		0.5133	0.4348		0.5069	0.4254
	0.5069	0.4254		0.5133	0.4348		0.5196	0.4346		0.5131	0.4252
	0.5006	0.4160		0.5069	0.4254		0.5131	0.4252		0.5066	0.4158

PERFORMANCE GROUPS - CHROMATICITY (CONTINUED)

Region	x	y	Region	x	y	Region	x	y	Region	x	y
AC1	0.5066	0.4158	AC2	0.5131	0.4252	AC3	0.5192	0.4250	AC4	0.5126	0.4156
	0.5131	0.4252		0.5196	0.4346		0.5258	0.4343		0.5192	0.4250
	0.5192	0.4250		0.5258	0.4343		0.5321	0.4341		0.5253	0.4248
	0.5126	0.4156		0.5192	0.4250		0.5253	0.4248		0.5186	0.4154
AD1	0.4936	0.3970	AD2	0.5001	0.4064	AD3	0.5059	0.4062	AD4	0.4993	0.3969
	0.5001	0.4064		0.5066	0.4158		0.5126	0.4156		0.5059	0.4062
	0.5059	0.4062		0.5126	0.4156		0.5186	0.4154		0.5118	0.4061
	0.4993	0.3969		0.5059	0.4062		0.5118	0.4061		0.5050	0.3967

XLamp XP-G3 white (Standard) and XP-G3 white (S Line) LEDs are tested for chromaticity and placed into one of the regions defined by the following bounding coordinates.

EasyWhite Color Temperatures – 3-Step Ellipse						
Bin Code	CCT	Center Point		Major Axis	Minor Axis	Rotation Angle (°)
		x	y	a	b	
6G	3500 K	0.4073	0.3917	0.00927	0.00414	53.2
7G	3000 K	0.4338	0.4030	0.00834	0.00408	53.2
8G	2700 K	0.4577	0.4099	0.00834	0.00420	48.5

EasyWhite Color Temperatures – 5-Step Ellipse						
Bin Code	CCT	Center Point		Major Axis	Minor Axis	Rotation Angle (°)
		x	y	a	b	
2E	5700 K	0.3287	0.3417	0.01230	0.00600	72.0
3E	5000 K	0.3447	0.3553	0.01400	0.00520	65.0
4E	4500 K	0.3611	0.3658	0.01420	0.00550	61.5
5E	4000 K	0.3818	0.3797	0.01565	0.00670	53.7
6E	3500 K	0.4073	0.3917	0.01545	0.00690	54.0
7E	3000 K	0.4338	0.4030	0.01390	0.00680	53.2
8E	2700 K	0.4577	0.4099	0.01350	0.00700	48.5

CREE'S STANDARD CHROMATICITY REGIONS PLOTTED ON THE 1931 CIE CURVE

ANSI Cool White



Neutral White

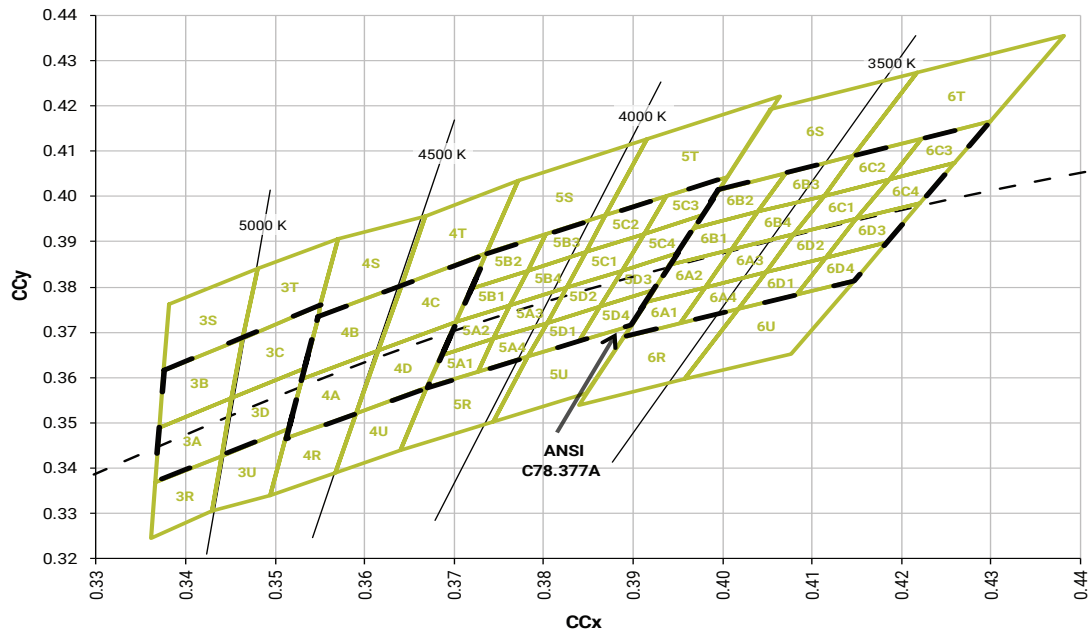

CREE'S STANDARD CHROMATICITY REGIONS PLOTTED ON THE 1931 CIE CURVE - CONTINUED

ANSI Neutral White and ANSI Warm White



CREE'S STANDARD COOL WHITE KITS PLOTTED ON ANSI STANDARD CHROMATICITY REGIONS

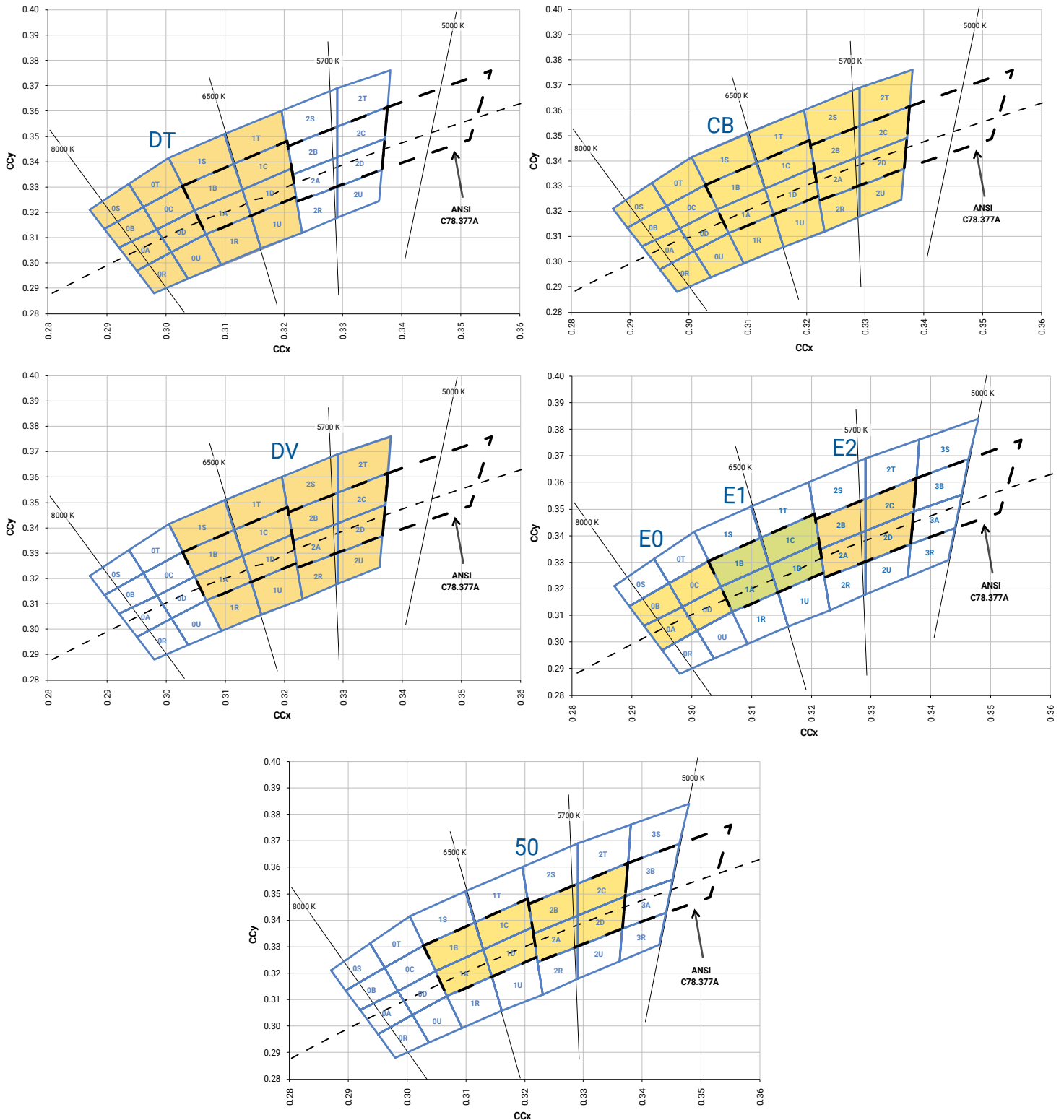

CREE'S STANDARD WARM AND NEUTRAL WHITE KITS PLOTTED ON ANSI STANDARD CHROMATICITY REGIONS



CREE'S STANDARD WARM AND NEUTRAL WHITE KITS PLOTTED ON ANSI STANDARD CHROMATICITY REGIONS - CONTINUED

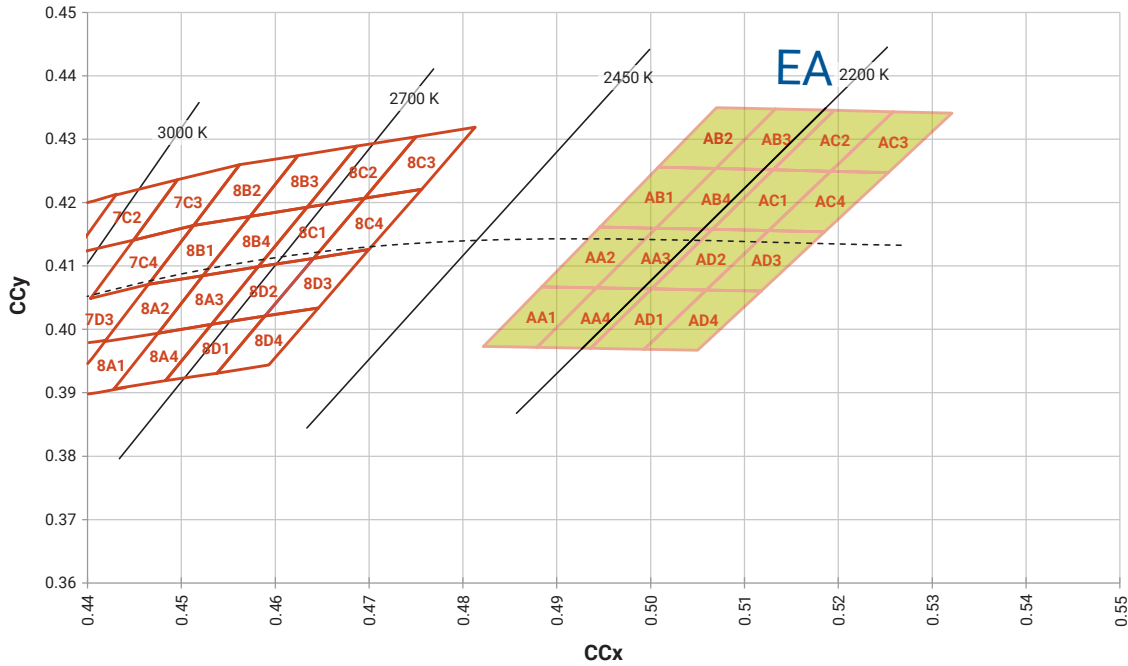

CREE'S EASYWHITE® WHITE KITS PLOTTED ON ANSI STANDARD CHROMATICITY REGIONS



CREE'S STANDARD CHROMATICITY KITS

The following table provides the chromaticity bins associated with chromaticity kits.

Color	CCT	Kit	Chromaticity Bins
Cool White	7000 K	DT	0A, 0B, 0C, 0D, 0R, 0S, 0T, 0U, 1A, 1B, 1C, 1D, 1R, 1S, 1T, 1U
	6500 K	CB	0A, 0B, 0C, 0D, 0R, 0S, 0T, 0U, 1A, 1B, 1C, 1D, 1R, 1S, 1T, 1U, 2A, 2B, 2C, 2D, 2R, 2S, 2T, 2U
	>6500 K	E0	0A, 0B, 0C, 0D
	6500 K	E1	1A, 1B, 1C, 1D
	6000 K	DV	1A, 1B, 1C, 1D, 1R, 1S, 1T, 1U, 2A, 2B, 2C, 2D, 2R, 2S, 2T, 2U
	6200 K	50	1A, 1B, 1C, 1D, 2A, 2B, 2C, 2D
	5700 K	E2	2A, 2B, 2C, 2D
	5700 K	2E	57E
Neutral White	5000 K	3E	50E
	5000 K	E3	3A, 3B, 3C, 3D
	4750 K	F4	3C, 3D, 4A, 4B
	4500 K	4E	45E
	4500 K	E4	4A, 4B, 4C, 4D
	4250 K	F5	4C, 4D, 5A1, 5A2, 5A3, 5A4, 5B1, 5B2, 5B3, 5B4
	4000 K	5E	40E
	4000 K	E5	5A1, 5A2, 5A3, 5A4, 5B1, 5B2, 5B3, 5B4, 5C1, 5C2, 5C3, 5C4, 5D1, 5D2, 5D3, 5D4
Warm White	3750 K	F6	5C1, 5C2, 5C3, 5C4, 5D1, 5D2, 5D3, 5D4, 6A1, 6A2, 6A3, 6A4, 6B1, 6B2, 6B3, 6B4
	3500 K	6E	35E, 35G
	3500 K	6G	35G
	3500 K	E6	6A1, 6A2, 6A3, 6A4, 6B1, 6B2, 6B3, 6B4, 6C1, 6C2, 6C3, 6C4, 6D1, 6D2, 6D3, 6D4
	3250 K	F7	6C1, 6C2, 6C3, 6C4, 6D1, 6D2, 6D3, 6D4, 7A1, 7A2, 7A3, 7A4, 7B1, 7B2, 7B3, 7B4
	3000 K	7E	30E, 30G
	3000 K	7G	30G
	3000 K	E7	7A1, 7A2, 7A3, 7A4, 7B1, 7B2, 7B3, 7B4, 7C1, 7C2, 7C3, 7C4, 7D1, 7D2, 7D3, 7D4
	2850 K	F8	7C1, 7C2, 7C3, 7C4, 7D1, 7D2, 7D3, 7D4, 8A1, 8A2, 8A3, 8A4, 8B1, 8B2, 8B3, 8B4
	2700 K	8E	27E, 27G
	2700 K	8G	27G
	2700 K	E8	8A1, 8A2, 8A3, 8A4, 8B1, 8B2, 8B3, 8B4, 8C1, 8C2, 8C3, 8C4, 8D1, 8D2, 8D3, 8D4
	2200 K	EA	AA1, AA2, AA3, AA4, AB1, AB2, AB3, AB4, AC1, AC2, AC3, AC4, AD1, AD2, AD3, AD4

BIN AND ORDER CODE FORMATS

XP-G3 bin codes and order codes are configured in the following manner:

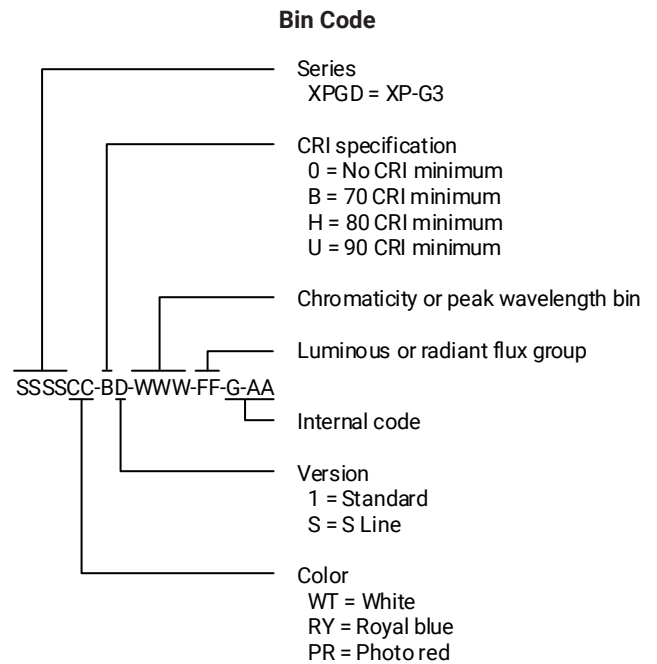

REFLOW SOLDERING CHARACTERISTICS

In testing, Cree has found XLamp XP-G3 LEDs to be compatible with JEDEC J-STD-020C, with the exception of the peak temperature requirements listed in the table below. As a general guideline, Cree recommends that users follow the recommended soldering profile provided by the manufacturer of the solder paste used, and therefore it is the lamp or luminaire manufacturer’s responsibility to determine applicable soldering requirements.

Note that this general guideline may not apply to all PCB designs and configurations of reflow soldering equipment.



Profile Feature	Lead-Free Solder
Average Ramp-Up Rate ($T_{s_{max}}$ to T_P)	1.2 °C/second
Preheat: Temperature Min ($T_{s_{min}}$)	120 °C
Preheat: Temperature Max ($T_{s_{max}}$)	170 °C
Preheat: Time ($t_{s_{min}}$ to $t_{s_{max}}$)	65-150 seconds
Time Maintained Above: Temperature (T_L)	217 °C
Time Maintained Above: Time (t_L)	45-90 seconds
Peak/Classification Temperature (T_P)	235 - 245 °C
Time Within 5 °C of Actual Peak Temperature (t_p)	20-40 seconds
Ramp-Down Rate	1 - 6 °C/second
Time 25 °C to Peak Temperature	4 minutes max.

Note: All temperatures refer to topside of the package, measured on the package body surface.

NOTES

Measurements

The luminous flux, radiant power, chromaticity, forward voltage and CRI measurements in this document are binning specifications only and solely represent product measurements as of the date of shipment. These measurements will change over time based on a number of factors that are not within Cree's control and are not intended or provided as operational specifications for the products. Calculated values are provided for informational purposes only and are not intended or provided as specifications.

Pre-Release Qualification Testing

Please read the [LED Reliability Overview](#) for details of the qualification process Cree applies to ensure long-term reliability for XLamp LEDs and details of Cree's pre-release qualification testing for XLamp LEDs. Cree did not perform Room Temperature Operating Life (RTOL) testing on the XP-G3 LED.

Lumen Maintenance

Cree now uses standardized IES LM-80-08 and TM-21-11 methods for collecting long-term data and extrapolating LED lumen maintenance. For information on the specific LM-80 data sets available for this LED, refer to the public [LM-80 results document](#).

Please read the [Long-Term Lumen Maintenance application note](#) for more details on Cree's lumen maintenance testing and forecasting. Please read the [Thermal Management application note](#) for details on how thermal design, ambient temperature, and drive current affect the LED junction temperature.

Moisture Sensitivity

Cree recommends keeping XLamp LEDs in the provided, resealable moisture-barrier packaging (MBP) until immediately prior to soldering. Unopened MBPs that contain XLamp LEDs do not need special storage for moisture sensitivity.

Once the MBP is opened, XLamp XP-G3 LEDs may be stored as MSL 1 per JEDEC J-STD-033, meaning they have unlimited floor life in conditions of ≤ 30 °C/85% relative humidity (RH). Regardless of the storage condition, Cree recommends sealing any unsoldered LEDs in the original MBP.

RoHS Compliance

The levels of RoHS restricted materials in this product are below the maximum concentration values (also referred to as the threshold limits) permitted for such substances, or are used in an exempted application, in accordance with EU Directive 2011/65/EC (RoHS2), as implemented January 2, 2013. RoHS Declarations for this product can be obtained from your Cree representative or from the [Product Ecology](#) section of the Cree website.

REACH Compliance

REACH substances of very high concern (SVHCs) information is available for this product. Since the European Chemical Agency (ECHA) has published notice of their intent to frequently revise the SVHC listing for the foreseeable future, please contact a Cree representative to insure you get the most up-to-date REACH Declaration. REACH banned substance information (REACH Article 67) is also available upon request.

NOTES - CONTINUED

UL® Recognized Component

This product meets the requirements to be considered a UL Recognized Component with Level 4 enclosure consideration. The LED package or a portion thereof has been investigated as a fire and electrical enclosure per ANSI/UL 8750.

Vision Advisory

WARNING: Do not look at an exposed lamp in operation. Eye injury can result. For more information about LEDs and eye safety, please refer to the [LED Eye Safety application note](#).

MECHANICAL DIMENSIONS ($T_A = 25\text{ }^\circ\text{C}$)

Thermal vias, if present, are not shown on these drawings.

All measurements are $\pm .13\text{ mm}$ unless otherwise indicated.

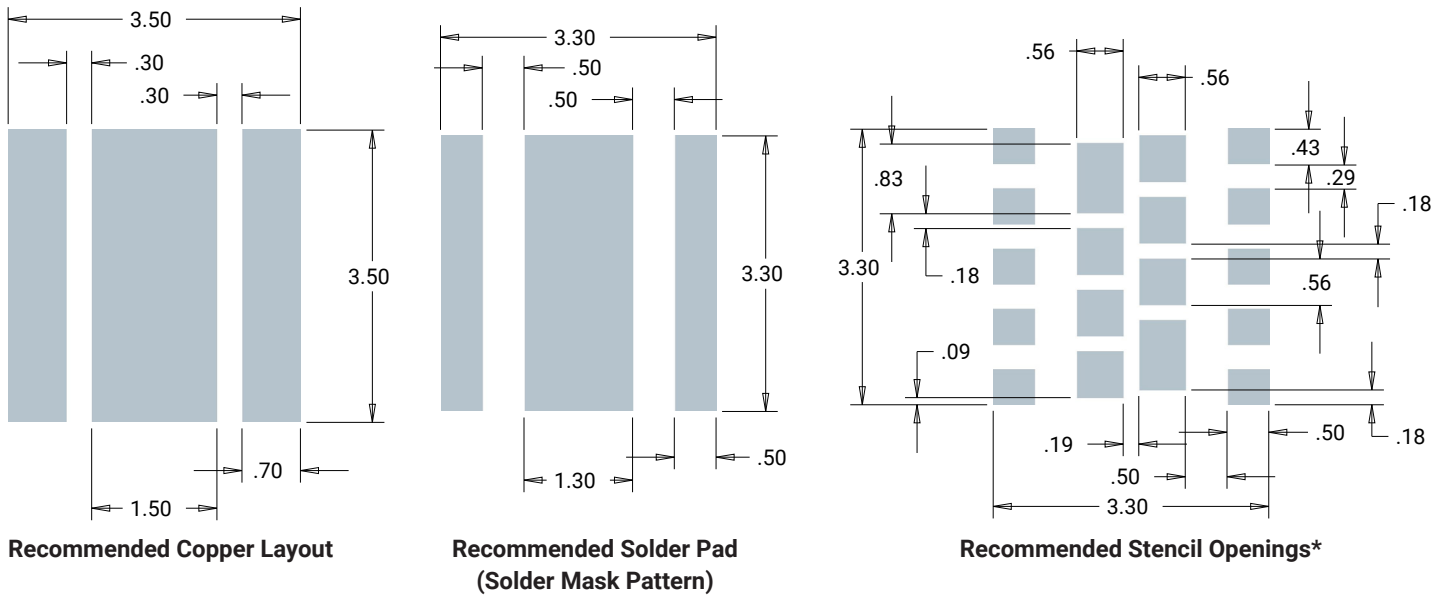
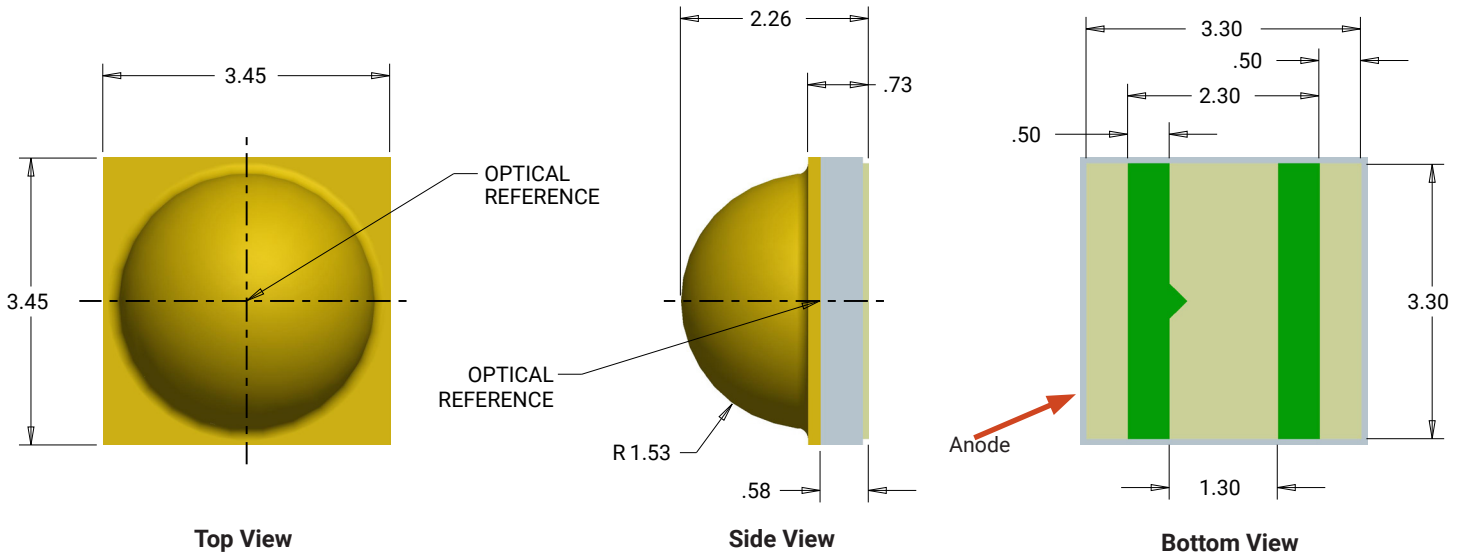

Notes:

- Cree recommends using thermal pad kickouts to maximize component thermal performance.
- Cree recommends using white solder mask material to minimize system optical loss.
- * This stencil has been tested and optimized for the avoidance of voiding when using ALPHA® LUMET® P30 Maxrel solder paste. For other solder pastes, a "window pane" design for the thermal pad stencil may result in a lower voiding percentage. Contact your local Cree Field Applications Engineer for consultation regarding your specific application.

TAPE AND REEL

All Cree carrier tapes conform to EIA-481D, Automated Component Handling Systems Standard.

All dimensions in mm.



Ao	3.70	+/- 0.1
Bo	3.70	+/- 0.1
Ko	2.40	+0.0/-0.1
F	5.50	+/- 0.05
P 1	8.00	+/- 0.1
W	12.00	+0.3/-0.1

- (I) Measured from centerline of sprocket hole to centerline of pocket.
- (II) Cumulative tolerance of 10 sprocket holes is ±0.20.
- (III) Measured from centerline of sprocket hole to centerline of pocket.
- (IV) Other material available.

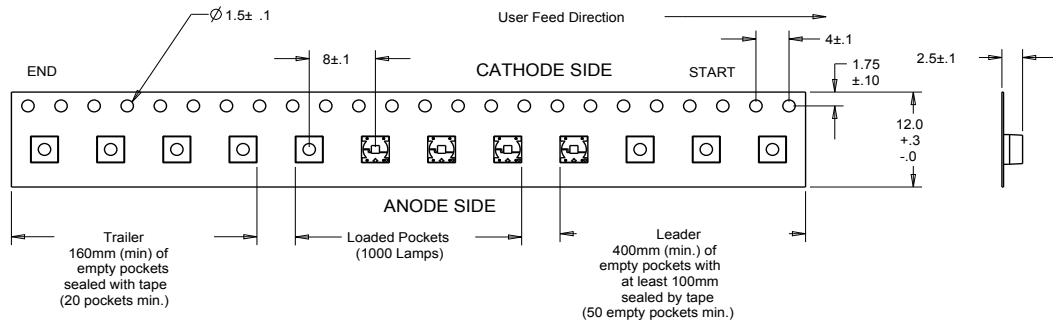

PACKAGING

Unpackaged Reel



Label with Cree Bin Code,
Quantity, Reel ID

Packaged Reel



Label with Cree Order Code,
Quantity, Reel ID, PO #

Label with Cree Bin Code,
Quantity, Reel ID

Boxed Reel



Label with Cree Order Code,
Quantity, Reel ID, PO #

Label with Cree Bin Code,
Quantity, Reel ID

Patent Label
(on bottom of box)



Компания «ЭлектроПласт» предлагает заключение долгосрочных отношений при поставках импортных электронных компонентов на взаимовыгодных условиях!

Наши преимущества:

- Оперативные поставки широкого спектра электронных компонентов отечественного и импортного производства напрямую от производителей и с крупнейших мировых складов;
- Поставка более 17-ти миллионов наименований электронных компонентов;
- Поставка сложных, дефицитных, либо снятых с производства позиций;
- Оперативные сроки поставки под заказ (от 5 рабочих дней);
- Экспресс доставка в любую точку России;
- Техническая поддержка проекта, помощь в подборе аналогов, поставка прототипов;
- Система менеджмента качества сертифицирована по Международному стандарту ISO 9001;
- Лицензия ФСБ на осуществление работ с использованием сведений, составляющих государственную тайну;
- Поставка специализированных компонентов (Xilinx, Altera, Analog Devices, Intersil, Interpoint, Microsemi, Aeroflex, Peregrine, Syfer, Eurofarad, Texas Instrument, Miteq, Cobham, E2V, MA-COM, Hittite, Mini-Circuits, General Dynamics и др.);

Помимо этого, одним из направлений компании «ЭлектроПласт» является направление «Источники питания». Мы предлагаем Вам помощь Конструкторского отдела:

- Подбор оптимального решения, техническое обоснование при выборе компонента;
- Подбор аналогов;
- Консультации по применению компонента;
- Поставка образцов и прототипов;
- Техническая поддержка проекта;
- Защита от снятия компонента с производства.



Как с нами связаться

Телефон: 8 (812) 309 58 32 (многоканальный)

Факс: 8 (812) 320-02-42

Электронная почта: org@eplast1.ru

Адрес: 198099, г. Санкт-Петербург, ул. Калинина, дом 2, корпус 4, литера А.