

Cree® XLamp® XP-G3 LEDs

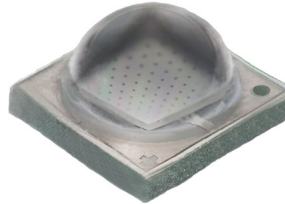

XP-G3 White



XP-G3 Royal Blue

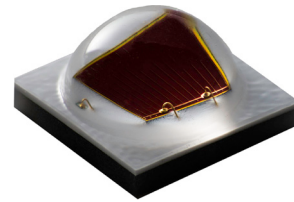

XP-G3 Photo Red

PRODUCT DESCRIPTION

XLamp® XP-G3 LEDs are optimized for directional, high-lumen lighting applications where efficacy and optical control are critical, such as roadway, portable and horticulture. The compact and proven 3.45-mm XP platform has an excellent ecosystem of optics and system solutions available, enabling lighting manufacturers to simplify their design process and shorten time-to-market.

XP-G3 LEDs are available in royal blue, photo red and two different white versions. White (Standard) delivers best-in-class TM-21 lifetimes and color stability over time. White (S Line) improves on the Standard version: better system-level reliability through switching and dimming cycles, improved resistance to sulfur exposure and higher efficacy. With this S Line version, Cree delivers high-power LED technology that is optimized for robust lighting applications where sensors and the internet-of-things (IOT) are becoming common.

FEATURES

- Available in no CRI minimum white, 70-, 80- and 90-CRI white, royal blue & photo red
- ANSI-compatible chromaticity bins
- 3-step and 5-step options
- White binned at 85 °C, royal blue & photo red binned at 25 °C
- Maximum drive current: white, royal blue: 2000 mA, photo red: 1500 mA
- Low thermal resistance: white: 3 °C/W, royal blue: 2 °C/W, photo red: 2.5 °C/W
- Wide viewing angle: 125°–130°
- Unlimited floor life at ≤ 30 °C/85% RH
- Reflow solderable - JEDEC J-STD-020C
- Electrically neutral thermal path
- RoHS and REACH compliant
- UL® recognized component (E349212)



TABLE OF CONTENTS

Characteristics 3

Flux Characteristics - White (Standard)..... 4

Flux Characteristics - White (S Line)..... 13

Flux Characteristics - Color 15

Relative Spectral Power Distribution - White (Standard) 16

Relative Spectral Power Distribution - White (S Line) 16

Relative Spectral Power Distribution - Color 17

Relative Flux vs. Junction Temperature - White (Standard) 17

Relative Flux vs. Junction Temperature - White (S Line) 18

Relative Flux vs. Junction Temperature - Color..... 18

Electrical Characteristics - White (Standard) 19

Electrical Characteristics - White (S Line) 19

Electrical Characteristics - Color..... 20

Relative Luminous Flux vs. Current - White (Standard) 20

Relative Luminous Flux vs. Current - White (S Line) 21

Relative Radiant Flux vs. Current - Color 21

Relative Chromaticity vs. Current and Temperature 22

Typical Spatial Distribution - White (Standard) 23

Typical Spatial Distribution - White (S Line) 23

Typical Spatial Distribution - Color..... 24

Thermal Design 25

Performance Groups - Luminous Flux 26

Performance Groups - Radiant Flux 26

Performance Groups - Peak Wavelength..... 27

Performance Groups - Forward Voltage..... 27

Performance Groups - Chromaticity 28

Cree’s Standard Chromaticity Regions Plotted on the 1931 CIE Curve 32

Cree’s Standard Cool White Kits Plotted on ANSI Standard Chromaticity Regions..... 34

Cree’s Standard Warm and Neutral White Kits Plotted on ANSI Standard Chromaticity Regions 35

Cree’s EasyWhite® White Kits Plotted on ANSI Standard Chromaticity Regions 36

Cree’s Standard Chromaticity Kits 37

Bin and Order Code Formats 38

Reflow Soldering Characteristics..... 39

Notes 40

Mechanical Dimensions 42

Tape and Reel..... 43

Packaging..... 44

CHARACTERISTICS

| Characteristics | Unit | Minimum | Typical | Maximum |
|---|---------|---------|----------|---------|
| Thermal resistance, junction to solder point - standard, S Line | °C/W | | 3 | |
| Thermal resistance, junction to solder point - royal blue | °C/W | | 2 | |
| Thermal resistance, junction to solder point - photo red | °C/W | | 2.5 | |
| Viewing angle (FWHM) - standard, S Line | degrees | | 125 | |
| Viewing angle (FWHM) - royal blue | degrees | | 130 | |
| Viewing angle (FWHM) - photo red | degrees | | 125 | |
| Temperature coefficient of voltage | mV/°C | | -1.3 | |
| ESD withstand voltage (HBM per Mil-Std-883D) | | | Class 3A | |
| DC forward current - standard, S Line, royal blue | mA | | | 2000 |
| DC forward current - photo red | mA | | | 1500 |
| Reverse voltage | V | | | 5 |
| Forward voltage (@ 350 mA, 85 °C) - standard, S Line | V | | 2.70 | 2.90 |
| Forward voltage (@ 350 mA, 25 °C) - royal blue | V | | 2.79 | 3.0 |
| Forward voltage (@ 350 mA, 25 °C) - photo red | V | | 1.99 | 2.2 |
| Forward voltage (@ 700 mA, 85 °C) - standard, S Line | V | | 2.80 | |
| Forward voltage (@ 700 mA, 25 °C) - royal blue | V | | 2.90 | |
| Forward voltage (@ 700 mA, 25 °C) - photo red | V | | 2.18 | |
| Forward voltage (@ 1000 mA, 85 °C) - standard, S Line | V | | 2.87 | |
| Forward voltage (@ 1000 mA, 25 °C) - royal blue | V | | 2.99 | |
| Forward voltage (@ 1000 mA, 25 °C) - photo red | V | | 2.36 | |
| Forward voltage (@ 1500 mA, 85 °C) - standard, S Line | V | | 2.97 | |
| Forward voltage (@ 1500 mA, 25 °C) - royal blue | V | | 3.11 | |
| Forward voltage (@ 1500 mA, 25 °C) - photo red | V | | 2.65 | |
| Forward voltage (@ 2000 mA, 85 °C) - standard, S Line | V | | 3.06 | |
| Forward voltage (@ 2000 mA, 25 °C) - royal blue | V | | 3.20 | |
| LED junction temperature | °C | | | 150 |

FLUX CHARACTERISTICS - WHITE (STANDARD) - $T_j = 85\text{ }^\circ\text{C}$

The following table provides order codes for XLamp XP-G3 White (Standard) LEDs. For a complete description of the order code nomenclature, please see the Bin and Order Code Formats section (page 38). For definitions of the chromaticity kits, please see the Cree's Standard Chromaticity Kits section (page 37).

| Chromaticity | | Minimum Luminous Flux (lm) @ 350 mA | | | Order Codes | | | |
|--------------|---------|-------------------------------------|-------------------|--------------------|----------------------|----------------------|----------------------|----------------------|
| Kit | CCT | Code | Flux (lm) @ 85 °C | Flux (lm) @ 25 °C* | 70 CRI Typical | 70 CRI Minimum | 80 CRI Minimum | 90 CRI Minimum |
| DT | 7000 K | S5 | 172 | 187 | | XPGDWT-B1-0000-00MDT | | |
| | | S4 | 164 | 179 | XPGDWT-01-0000-00LDT | XPGDWT-B1-0000-00LDT | | |
| | | S3 | 156 | 170 | XPGDWT-01-0000-00KDT | XPGDWT-B1-0000-00KDT | XPGDWT-H1-0000-00KDT | |
| | | S2 | 148 | 161 | XPGDWT-01-0000-00JDT | XPGDWT-B1-0000-00JDT | XPGDWT-H1-0000-00JDT | |
| | | R5 | 139 | 152 | | | XPGDWT-H1-0000-00HDT | |
| CB | 6500 K | S3 | 156 | 170 | | | XPGDWT-H1-0000-00KCB | |
| | | S2 | 148 | 161 | | | XPGDWT-H1-0000-00JCB | |
| | | R5 | 139 | 152 | | | XPGDWT-H1-0000-00HCB | |
| E0 | >6500 K | S4 | 164 | 179 | XPGDWT-01-0000-00LE0 | XPGDWT-B1-0000-00LE0 | | |
| | | S3 | 156 | 170 | XPGDWT-01-0000-00KE0 | XPGDWT-B1-0000-00KE0 | XPGDWT-H1-0000-00KE0 | |
| | | S2 | 148 | 161 | XPGDWT-01-0000-00JE0 | XPGDWT-B1-0000-00JE0 | XPGDWT-H1-0000-00JE0 | |
| | | R5 | 139 | 152 | | | XPGDWT-H1-0000-00HE0 | |
| E1 | 6500 K | S4 | 164 | 179 | XPGDWT-01-0000-00LE1 | XPGDWT-B1-0000-00LE1 | | |
| | | S3 | 156 | 170 | XPGDWT-01-0000-00KE1 | XPGDWT-B1-0000-00KE1 | XPGDWT-H1-0000-00KE1 | |
| | | S2 | 148 | 161 | XPGDWT-01-0000-00JE1 | XPGDWT-B1-0000-00JE1 | XPGDWT-H1-0000-00JE1 | |
| | | R5 | 139 | 152 | | | XPGDWT-H1-0000-00HE1 | |
| DV | 6000 K | S5 | 172 | 187 | XPGDWT-01-0000-00MDV | XPGDWT-B1-0000-00MDV | | |
| | | S4 | 164 | 179 | XPGDWT-01-0000-00LDV | XPGDWT-B1-0000-00LDV | | |
| | | S3 | 156 | 170 | XPGDWT-01-0000-00KDV | XPGDWT-B1-0000-00KDV | XPGDWT-H1-0000-00KDV | |
| | | S2 | 148 | 161 | XPGDWT-01-0000-00JDV | XPGDWT-B1-0000-00JDV | XPGDWT-H1-0000-00JDV | |
| | | R5 | 139 | 152 | | | XPGDWT-H1-0000-00HDV | |
| | | R4 | 130 | 142 | | | | |
| | | R3 | 122 | 133 | | | | XPGDWT-U1-0000-00FDV |
| | | R2 | 114 | 124 | | | | XPGDWT-U1-0000-00EDV |

Notes

- Cree maintains a tolerance of $\pm 7\%$ on flux and power measurements, ± 0.005 on chromaticity (CCx, CCy) measurements and a tolerance of ± 2 on CRI measurements. See the Measurements section (page 40).
- Cree XLamp XP-G3 LED order codes specify only a minimum flux bin and not a maximum. Cree may ship reels in flux bins higher than the minimum specified by the order code without advance notice. Shipments will always adhere to the chromaticity bin restrictions specified by the order code.
- * Flux values @ 25 °C are calculated and for reference only.

FLUX CHARACTERISTICS - WHITE (STANDARD) - $T_j = 85\text{ }^\circ\text{C}$ (CONTINUED)

| Chromaticity | | Minimum Luminous Flux (lm) @ 350 mA | | | Order Codes | | | |
|--------------|--------|-------------------------------------|-------------------|--------------------|----------------------|----------------------|----------------------|----------------------|
| Kit | CCT | Code | Flux (lm) @ 85 °C | Flux (lm) @ 25 °C* | 70 CRI Typical | 70 CRI Minimum | 80 CRI Minimum | 90 CRI Minimum |
| 50 | 6000 K | S5 | 172 | 187 | XPGDWT-01-0000-00M50 | XPGDWT-B1-0000-00M50 | | |
| | | S4 | 164 | 179 | XPGDWT-01-0000-00L50 | XPGDWT-B1-0000-00L50 | | |
| | | S3 | 156 | 170 | XPGDWT-01-0000-00K50 | XPGDWT-B1-0000-00K50 | XPGDWT-H1-0000-00K50 | |
| | | S2 | 148 | 161 | XPGDWT-01-0000-00J50 | XPGDWT-B1-0000-00J50 | XPGDWT-H1-0000-00J50 | |
| | | R5 | 139 | 152 | | | XPGDWT-H1-0000-00H50 | |
| | | R4 | 130 | 142 | | | | |
| | | R3 | 122 | 133 | | | | XPGDWT-U1-0000-00F50 |
| | | R2 | 114 | 124 | | | | XPGDWT-U1-0000-00E50 |
| E2 | 5700 K | S5 | 172 | 187 | XPGDWT-01-0000-00ME2 | XPGDWT-B1-0000-00ME2 | | |
| | | S4 | 164 | 179 | XPGDWT-01-0000-00LE2 | XPGDWT-B1-0000-00LE2 | | |
| | | S3 | 156 | 170 | XPGDWT-01-0000-00KE2 | XPGDWT-B1-0000-00KE2 | XPGDWT-H1-0000-00KE2 | |
| | | S2 | 148 | 161 | XPGDWT-01-0000-00JE2 | XPGDWT-B1-0000-00JE2 | XPGDWT-H1-0000-00JE2 | |
| | | R5 | 139 | 152 | | | XPGDWT-H1-0000-00HE2 | |
| | | R4 | 130 | 142 | | | | |
| | | R3 | 122 | 133 | | | | XPGDWT-U1-0000-00FE2 |
| | | R2 | 114 | 124 | | | | XPGDWT-U1-0000-00EE2 |
| 2E | 5700 K | S5 | 172 | 187 | | XPGDWT-B1-0000-00M2E | | |
| | | S4 | 164 | 179 | | XPGDWT-B1-0000-00L2E | | |
| | | S3 | 156 | 170 | | XPGDWT-B1-0000-00K2E | XPGDWT-H1-0000-00K2E | |
| | | S2 | 148 | 161 | | XPGDWT-B1-0000-00J2E | XPGDWT-H1-0000-00J2E | |
| | | R5 | 139 | 152 | | | XPGDWT-H1-0000-00H2E | |
| | | R4 | 130 | 142 | | | | |
| | | R3 | 122 | 133 | | | | XPGDWT-U1-0000-00F2E |
| | | R2 | 114 | 124 | | | | XPGDWT-U1-0000-00E2E |

Notes

- Cree maintains a tolerance of $\pm 7\%$ on flux and power measurements, ± 0.005 on chromaticity (CCx, CCy) measurements and a tolerance of ± 2 on CRI measurements. See the Measurements section (page 40).
- Cree XLamp XP-G3 LED order codes specify only a minimum flux bin and not a maximum. Cree may ship reels in flux bins higher than the minimum specified by the order code without advance notice. Shipments will always adhere to the chromaticity bin restrictions specified by the order code.
- * Flux values @ 25 °C are calculated and for reference only.

FLUX CHARACTERISTICS - WHITE (STANDARD) - $T_j = 85\text{ }^\circ\text{C}$ (CONTINUED)

| Chromaticity | | Minimum Luminous Flux (lm) @ 350 mA | | | Order Codes | | | |
|--------------|--------|-------------------------------------|-------------------|--------------------|----------------------|----------------------|----------------------|----------------------|
| Kit | CCT | Code | Flux (lm) @ 85 °C | Flux (lm) @ 25 °C* | 70 CRI Typical | 70 CRI Minimum | 80 CRI Minimum | 90 CRI Minimum |
| 3E | 5000 K | S5 | 172 | 187 | | XPGDWT-B1-0000-00M3E | | |
| | | S4 | 164 | 179 | | XPGDWT-B1-0000-00L3E | | |
| | | S3 | 156 | 170 | | XPGDWT-B1-0000-00K3E | XPGDWT-H1-0000-00K3E | |
| | | S2 | 148 | 161 | | XPGDWT-B1-0000-00J3E | XPGDWT-H1-0000-00J3E | |
| | | R5 | 139 | 152 | | | XPGDWT-H1-0000-00H3E | |
| | | R4 | 130 | 142 | | | | |
| | | R3 | 122 | 133 | | | | XPGDWT-U1-0000-00F3E |
| | | R2 | 114 | 124 | | | | XPGDWT-U1-0000-00E3E |
| E3 | 5000 K | S5 | 172 | 187 | XPGDWT-01-0000-00ME3 | XPGDWT-B1-0000-00ME3 | | |
| | | S4 | 164 | 179 | XPGDWT-01-0000-00LE3 | XPGDWT-B1-0000-00LE3 | | |
| | | S3 | 156 | 170 | XPGDWT-01-0000-00KE3 | XPGDWT-B1-0000-00KE3 | XPGDWT-H1-0000-00KE3 | |
| | | S2 | 148 | 161 | XPGDWT-01-0000-00JE3 | XPGDWT-B1-0000-00JE3 | XPGDWT-H1-0000-00JE3 | |
| | | R5 | 139 | 152 | | | XPGDWT-H1-0000-00HE3 | |
| | | R4 | 130 | 142 | | | | |
| | | R3 | 122 | 133 | | | | XPGDWT-U1-0000-00FE3 |
| | | R2 | 114 | 124 | | | | XPGDWT-U1-0000-00EE3 |
| F4 | 4750K | S5 | 172 | 187 | | XPGDWT-B1-0000-00MF4 | | |
| | | S4 | 164 | 179 | XPGDWT-01-0000-00LF4 | XPGDWT-B1-0000-00LF4 | | |
| | | S3 | 156 | 170 | XPGDWT-01-0000-00KF4 | XPGDWT-B1-0000-00KF4 | XPGDWT-H1-0000-00KF4 | |
| | | S2 | 148 | 161 | XPGDWT-01-0000-00JF4 | XPGDWT-B1-0000-00JF4 | XPGDWT-H1-0000-00JF4 | |
| | | R5 | 139 | 152 | | XPGDWT-B1-0000-00HF4 | XPGDWT-H1-0000-00HF4 | |
| | | R4 | 130 | 142 | | | XPGDWT-H1-0000-00GF4 | |
| | | R3 | 122 | 133 | | | | XPGDWT-U1-0000-00FF4 |
| | | R2 | 114 | 124 | | | | XPGDWT-U1-0000-00EF4 |

Notes

- Cree maintains a tolerance of $\pm 7\%$ on flux and power measurements, ± 0.005 on chromaticity (CCx, CCy) measurements and a tolerance of ± 2 on CRI measurements. See the Measurements section (page 40).
- Cree XLamp XP-G3 LED order codes specify only a minimum flux bin and not a maximum. Cree may ship reels in flux bins higher than the minimum specified by the order code without advance notice. Shipments will always adhere to the chromaticity bin restrictions specified by the order code.
- * Flux values @ 25 °C are calculated and for reference only.

FLUX CHARACTERISTICS - WHITE (STANDARD) - $T_j = 85\text{ }^\circ\text{C}$ (CONTINUED)

| Chromaticity | | Minimum Luminous Flux (lm) @ 350 mA | | | Order Codes | | | |
|--------------|--------|-------------------------------------|-------------------|--------------------|----------------------|----------------------|----------------------|----------------------|
| Kit | CCT | Code | Flux (lm) @ 85 °C | Flux (lm) @ 25 °C* | 70 CRI Typical | 70 CRI Minimum | 80 CRI Minimum | 90 CRI Minimum |
| 4E | 4500K | S5 | 172 | 187 | | XPGDWT-B1-0000-00M4E | | |
| | | S4 | 164 | 179 | | XPGDWT-B1-0000-00L4E | | |
| | | S3 | 156 | 170 | | XPGDWT-B1-0000-00K4E | XPGDWT-H1-0000-00K4E | |
| | | S2 | 148 | 161 | | XPGDWT-B1-0000-00J4E | XPGDWT-H1-0000-00J4E | |
| | | R5 | 139 | 152 | | | XPGDWT-H1-0000-00H4E | |
| | | R4 | 130 | 142 | | | XPGDWT-H1-0000-00G4E | |
| | | R3 | 122 | 133 | | | | XPGDWT-U1-0000-00F4E |
| | | R2 | 114 | 124 | | | | XPGDWT-U1-0000-00E4E |
| | | Q5 | 107 | 117 | | | | XPGDWT-U1-0000-00D4E |
| E4 | 4500 K | S5 | 172 | 187 | | XPGDWT-B1-0000-00ME4 | | |
| | | S4 | 164 | 179 | XPGDWT-01-0000-00LE4 | XPGDWT-B1-0000-00LE4 | | |
| | | S3 | 156 | 170 | XPGDWT-01-0000-00KE4 | XPGDWT-B1-0000-00KE4 | XPGDWT-H1-0000-00KE4 | |
| | | S2 | 148 | 161 | XPGDWT-01-0000-00JE4 | XPGDWT-B1-0000-00JE4 | XPGDWT-H1-0000-00JE4 | |
| | | R5 | 139 | 152 | | XPGDWT-B1-0000-00HE4 | XPGDWT-H1-0000-00HE4 | |
| | | R4 | 130 | 142 | | | XPGDWT-H1-0000-00GE4 | |
| | | R3 | 122 | 133 | | | | XPGDWT-U1-0000-00FE4 |
| | | R2 | 114 | 124 | | | | XPGDWT-U1-0000-00EE4 |
| | | Q5 | 107 | 117 | | | | XPGDWT-U1-0000-00DE4 |
| F5 | 4200 K | S5 | 172 | 187 | | XPGDWT-B1-0000-00MF5 | | |
| | | S4 | 164 | 179 | XPGDWT-01-0000-00LF5 | XPGDWT-B1-0000-00LF5 | | |
| | | S3 | 156 | 170 | XPGDWT-01-0000-00KF5 | XPGDWT-B1-0000-00KF5 | | |
| | | S2 | 148 | 161 | XPGDWT-01-0000-00JF5 | XPGDWT-B1-0000-00JF5 | XPGDWT-H1-0000-00JF5 | |
| | | R5 | 139 | 152 | | XPGDWT-B1-0000-00HF5 | XPGDWT-H1-0000-00HF5 | |
| | | R4 | 130 | 142 | | | XPGDWT-H1-0000-00GF5 | |
| | | R3 | 122 | 133 | | | | XPGDWT-U1-0000-00FF5 |
| | | R2 | 114 | 124 | | | | XPGDWT-U1-0000-00EF5 |
| | | Q5 | 107 | 117 | | | | XPGDWT-U1-0000-00DF5 |

Notes

- Cree maintains a tolerance of $\pm 7\%$ on flux and power measurements, ± 0.005 on chromaticity (CCx, CCy) measurements and a tolerance of ± 2 on CRI measurements. See the Measurements section (page 40).
- Cree XLamp XP-G3 LED order codes specify only a minimum flux bin and not a maximum. Cree may ship reels in flux bins higher than the minimum specified by the order code without advance notice. Shipments will always adhere to the chromaticity bin restrictions specified by the order code.
- * Flux values @ 25 °C are calculated and for reference only.

FLUX CHARACTERISTICS - WHITE (STANDARD) - $T_j = 85\text{ }^\circ\text{C}$ (CONTINUED)

| Chromaticity | | Minimum Luminous Flux (lm) @ 350 mA | | | Order Codes | | | |
|--------------|--------|-------------------------------------|-------------------|--------------------|----------------------|----------------------|----------------------|----------------------|
| Kit | CCT | Code | Flux (lm) @ 85 °C | Flux (lm) @ 25 °C* | 70 CRI Typical | 70 CRI Minimum | 80 CRI Minimum | 90 CRI Minimum |
| 5E | 4000 K | S5 | 172 | 187 | | XPGDWT-B1-0000-00M5E | | |
| | | S4 | 164 | 179 | | XPGDWT-B1-0000-00L5E | | |
| | | S3 | 156 | 170 | | XPGDWT-B1-0000-00K5E | | |
| | | S2 | 148 | 161 | | XPGDWT-B1-0000-00J5E | XPGDWT-H1-0000-00J5E | |
| | | R5 | 139 | 152 | | | XPGDWT-H1-0000-00H5E | |
| | | R4 | 130 | 142 | | | XPGDWT-H1-0000-00G5E | |
| | | R3 | 122 | 133 | | | | XPGDWT-U1-0000-00F5E |
| | | R2 | 114 | 124 | | | | XPGDWT-U1-0000-00E5E |
| | | Q5 | 107 | 117 | | | | XPGDWT-U1-0000-00D5E |
| E5 | 4000 K | S5 | 172 | 187 | | XPGDWT-B1-0000-00ME5 | | |
| | | S4 | 164 | 179 | XPGDWT-01-0000-00LE5 | XPGDWT-B1-0000-00LE5 | | |
| | | S3 | 156 | 170 | XPGDWT-01-0000-00KE5 | XPGDWT-B1-0000-00KE5 | | |
| | | S2 | 148 | 161 | XPGDWT-01-0000-00JE5 | XPGDWT-B1-0000-00JE5 | XPGDWT-H1-0000-00JE5 | |
| | | R5 | 139 | 152 | | XPGDWT-B1-0000-00HE5 | XPGDWT-H1-0000-00HE5 | |
| | | R4 | 130 | 142 | | | XPGDWT-H1-0000-00GE5 | |
| | | R3 | 122 | 133 | | | | XPGDWT-U1-0000-00FE5 |
| | | R2 | 114 | 124 | | | | XPGDWT-U1-0000-00EE5 |
| | | Q5 | 107 | 117 | | | | XPGDWT-U1-0000-00DE5 |
| F6 | 3700 K | S4 | 164 | 179 | XPGDWT-01-0000-00LF6 | XPGDWT-B1-0000-00LF6 | | |
| | | S3 | 156 | 170 | XPGDWT-01-0000-00KF6 | XPGDWT-B1-0000-00KF6 | | |
| | | S2 | 148 | 161 | XPGDWT-01-0000-00JF6 | XPGDWT-B1-0000-00JF6 | XPGDWT-H1-0000-00JF6 | |
| | | R5 | 139 | 152 | XPGDWT-01-0000-00HF6 | XPGDWT-B1-0000-00HF6 | XPGDWT-H1-0000-00HF6 | |
| | | R4 | 130 | 142 | | | XPGDWT-H1-0000-00GF6 | |
| | | R3 | 122 | 133 | | | | |
| | | R2 | 114 | 124 | | | | XPGDWT-U1-0000-00EF6 |
| | | Q5 | 107 | 117 | | | | XPGDWT-U1-0000-00DF6 |
| | | Q4 | 100 | 109 | | | | XPGDWT-U1-0000-00CF6 |

Notes

- Cree maintains a tolerance of $\pm 7\%$ on flux and power measurements, ± 0.005 on chromaticity (CCx, CCy) measurements and a tolerance of ± 2 on CRI measurements. See the Measurements section (page 40).
- Cree XLamp XP-G3 LED order codes specify only a minimum flux bin and not a maximum. Cree may ship reels in flux bins higher than the minimum specified by the order code without advance notice. Shipments will always adhere to the chromaticity bin restrictions specified by the order code.
- * Flux values @ 25 °C are calculated and for reference only.

FLUX CHARACTERISTICS - WHITE (STANDARD) - T_j = 85 °C (CONTINUED)

| Chromaticity | | Minimum Luminous Flux (lm) @ 350 mA | | | Order Codes | | | |
|--------------|--------|-------------------------------------|-------------------|--------------------|----------------------|----------------------|----------------------|----------------------|
| Kit | CCT | Code | Flux (lm) @ 85 °C | Flux (lm) @ 25 °C* | 70 CRI Typical | 70 CRI Minimum | 80 CRI Minimum | 90 CRI Minimum |
| 6E | 3500 K | S4 | 164 | 179 | | XPGDWT-B1-0000-00L6E | | |
| | | S3 | 156 | 170 | | XPGDWT-B1-0000-00K6E | | |
| | | S2 | 148 | 161 | | XPGDWT-B1-0000-00J6E | XPGDWT-H1-0000-00J6E | |
| | | R5 | 139 | 152 | | XPGDWT-B1-0000-00H6E | XPGDWT-H1-0000-00H6E | |
| | | R4 | 130 | 142 | | | XPGDWT-H1-0000-00G6E | |
| | | R3 | 122 | 133 | | | | |
| | | R2 | 114 | 124 | | | | XPGDWT-U1-0000-00E6E |
| | | Q5 | 107 | 117 | | | | XPGDWT-U1-0000-00D6E |
| | | Q4 | 100 | 109 | | | | XPGDWT-U1-0000-00C6E |
| 6G | 3500 K | R2 | 114 | 124 | | | | XPGDWT-U1-0000-00E6G |
| | | Q5 | 107 | 117 | | | | XPGDWT-U1-0000-00D6G |
| | | Q4 | 100 | 109 | | | | XPGDWT-U1-0000-00C6G |
| E6 | 3500 K | S4 | 164 | 179 | | XPGDWT-B1-0000-00L6E | | |
| | | S3 | 156 | 170 | XPGDWT-01-0000-00KE6 | XPGDWT-B1-0000-00KE6 | | |
| | | S2 | 148 | 161 | XPGDWT-01-0000-00JE6 | XPGDWT-B1-0000-00JE6 | XPGDWT-H1-0000-00JE6 | |
| | | R5 | 139 | 152 | XPGDWT-01-0000-00HE6 | XPGDWT-B1-0000-00HE6 | XPGDWT-H1-0000-00HE6 | |
| | | R4 | 130 | 142 | | | XPGDWT-H1-0000-00GE6 | |
| | | R3 | 122 | 133 | | | | |
| | | R2 | 114 | 124 | | | | XPGDWT-U1-0000-00EE6 |
| | | Q5 | 107 | 117 | | | | XPGDWT-U1-0000-00DE6 |
| | | Q4 | 100 | 109 | | | | XPGDWT-U1-0000-00CE6 |

Notes

- Cree maintains a tolerance of ±7% on flux and power measurements, ±0.005 on chromaticity (CCx, CCy) measurements and a tolerance of ±2 on CRI measurements. See the Measurements section (page 40).
- Cree XLamp XP-G3 LED order codes specify only a minimum flux bin and not a maximum. Cree may ship reels in flux bins higher than the minimum specified by the order code without advance notice. Shipments will always adhere to the chromaticity bin restrictions specified by the order code.
- * Flux values @ 25 °C are calculated and for reference only.

FLUX CHARACTERISTICS - WHITE (STANDARD) - $T_j = 85\text{ }^\circ\text{C}$ (CONTINUED)

| Chromaticity | | Minimum Luminous Flux (lm) @ 350 mA | | | Order Codes | | | |
|--------------|--------|-------------------------------------|-------------------|--------------------|----------------------|----------------------|----------------------|----------------------|
| Kit | CCT | Code | Flux (lm) @ 85 °C | Flux (lm) @ 25 °C* | 70 CRI Typical | 70 CRI Minimum | 80 CRI Minimum | 90 CRI Minimum |
| F7 | 3200K | S4 | 164 | 179 | | XPGDWT-B1-0000-00LF7 | | |
| | | S3 | 156 | 170 | XPGDWT-01-0000-00KF7 | XPGDWT-B1-0000-00KF7 | | |
| | | S2 | 148 | 161 | XPGDWT-01-0000-00JF7 | XPGDWT-B1-0000-00JF7 | | |
| | | R5 | 139 | 152 | XPGDWT-01-0000-00HF7 | XPGDWT-B1-0000-00HF7 | XPGDWT-H1-0000-00HF7 | |
| | | R4 | 130 | 142 | | | XPGDWT-H1-0000-00GF7 | |
| | | R3 | 122 | 133 | | | | |
| | | R2 | 114 | 124 | | | | XPGDWT-U1-0000-00EF7 |
| | | Q5 | 107 | 117 | | | | XPGDWT-U1-0000-00DF7 |
| | | Q4 | 100 | 109 | | | | XPGDWT-U1-0000-00CF7 |
| 7E | 3000 K | S4 | 164 | 179 | | XPGDWT-B1-0000-00L7E | | |
| | | S3 | 156 | 170 | | XPGDWT-B1-0000-00K7E | | |
| | | S2 | 148 | 161 | | XPGDWT-B1-0000-00J7E | | |
| | | R5 | 139 | 152 | | XPGDWT-B1-0000-00H7E | XPGDWT-H1-0000-00H7E | |
| | | R4 | 130 | 142 | | | XPGDWT-H1-0000-00G7E | |
| | | R3 | 122 | 133 | | | | |
| | | R2 | 114 | 124 | | | | XPGDWT-U1-0000-00E7E |
| | | Q5 | 107 | 117 | | | | XPGDWT-U1-0000-00D7E |
| | | Q4 | 100 | 109 | | | | XPGDWT-U1-0000-00C7E |
| 7G | 3000 K | R2 | 114 | 124 | | | | XPGDWT-U1-0000-00E7G |
| | | Q5 | 107 | 117 | | | | XPGDWT-U1-0000-00D7G |
| | | Q4 | 100 | 109 | | | | XPGDWT-U1-0000-00C7G |

Notes

- Cree maintains a tolerance of $\pm 7\%$ on flux and power measurements, ± 0.005 on chromaticity (CCx, CCy) measurements and a tolerance of ± 2 on CRI measurements. See the Measurements section (page 40).
- Cree XLamp XP-G3 LED order codes specify only a minimum flux bin and not a maximum. Cree may ship reels in flux bins higher than the minimum specified by the order code without advance notice. Shipments will always adhere to the chromaticity bin restrictions specified by the order code.
- * Flux values @ 25 °C are calculated and for reference only.

FLUX CHARACTERISTICS - WHITE (STANDARD) - $T_j = 85\text{ }^\circ\text{C}$ (CONTINUED)

| Chromaticity | | Minimum Luminous Flux (lm) @ 350 mA | | | Order Codes | | | |
|--------------|--------|-------------------------------------|-------------------|--------------------|----------------------|----------------------|----------------------|----------------------|
| Kit | CCT | Code | Flux (lm) @ 85 °C | Flux (lm) @ 25 °C* | 70 CRI Typical | 70 CRI Minimum | 80 CRI Minimum | 90 CRI Minimum |
| E7 | 3000 K | S4 | 164 | 179 | | XPGDWT-B1-0000-00LE7 | | |
| | | S3 | 156 | 170 | XPGDWT-01-0000-00KE7 | XPGDWT-B1-0000-00KE7 | | |
| | | S2 | 148 | 161 | XPGDWT-01-0000-00JE7 | XPGDWT-B1-0000-00JE7 | | |
| | | R5 | 139 | 152 | XPGDWT-01-0000-00HE7 | XPGDWT-B1-0000-00HE7 | XPGDWT-H1-0000-00HE7 | |
| | | R4 | 130 | 142 | | | XPGDWT-H1-0000-00GE7 | |
| | | R3 | 122 | 133 | | | | |
| | | R2 | 114 | 124 | | | | XPGDWT-U1-0000-00EE7 |
| | | Q5 | 107 | 117 | | | | XPGDWT-U1-0000-00DE7 |
| | | Q4 | 100 | 109 | | | | |
| F8 | 2850 K | R5 | 139 | 152 | | | XPGDWT-H1-0000-00HF8 | |
| | | R4 | 130 | 142 | | | XPGDWT-H1-0000-00GF8 | |
| | | R3 | 122 | 133 | | | XPGDWT-H1-0000-00FF8 | |
| | | R2 | 114 | 124 | | | | XPGDWT-U1-0000-00EF8 |
| | | Q5 | 107 | 117 | | | | XPGDWT-U1-0000-00DF8 |
| | | Q4 | 100 | 109 | | | | XPGDWT-U1-0000-00CF8 |
| 8E | 2700 K | S4 | 164 | 179 | | XPGDWT-B1-0000-00L8E | | |
| | | S3 | 156 | 170 | | XPGDWT-B1-0000-00K8E | | |
| | | S2 | 148 | 161 | | XPGDWT-B1-0000-00J8E | | |
| | | R5 | 139 | 152 | | | XPGDWT-H1-0000-00H8E | |
| | | R4 | 130 | 142 | | | XPGDWT-H1-0000-00G8E | |
| | | R3 | 122 | 133 | | | XPGDWT-H1-0000-00F8E | |
| | | R2 | 114 | 124 | | | | XPGDWT-U1-0000-00E8E |
| | | Q5 | 107 | 117 | | | | XPGDWT-U1-0000-00D8E |
| | | Q4 | 100 | 109 | | | | XPGDWT-U1-0000-00C8E |
| 8G | 2700 K | R2 | 114 | 124 | | | | XPGDWT-U1-0000-00E8G |
| | | Q5 | 107 | 117 | | | | XPGDWT-U1-0000-00D8G |
| | | Q4 | 100 | 109 | | | | XPGDWT-U1-0000-00C8G |

Notes

- Cree maintains a tolerance of $\pm 7\%$ on flux and power measurements, ± 0.005 on chromaticity (CCx, CCy) measurements and a tolerance of ± 2 on CRI measurements. See the Measurements section (page 40).
- Cree XLamp XP-G3 LED order codes specify only a minimum flux bin and not a maximum. Cree may ship reels in flux bins higher than the minimum specified by the order code without advance notice. Shipments will always adhere to the chromaticity bin restrictions specified by the order code.
- * Flux values @ 25 °C are calculated and for reference only.

FLUX CHARACTERISTICS - WHITE (STANDARD) - $T_j = 85\text{ }^\circ\text{C}$ (CONTINUED)

| Chromaticity | | Minimum Luminous Flux (lm) @ 350 mA | | | Order Codes | | | |
|--------------|--------|-------------------------------------|-------------------|--------------------|----------------|----------------------|----------------------|----------------------|
| Kit | CCT | Code | Flux (lm) @ 85 °C | Flux (lm) @ 25 °C* | 70 CRI Typical | 70 CRI Minimum | 80 CRI Minimum | 90 CRI Minimum |
| E8 | 2700K | S4 | 164 | 179 | | XPGDWT-B1-0000-00LE8 | | |
| | | S3 | 156 | 170 | | XPGDWT-B1-0000-00KE8 | | |
| | | S2 | 148 | 161 | | XPGDWT-B1-0000-00JE8 | | |
| | | R5 | 139 | 152 | | | XPGDWT-H1-0000-00HE8 | |
| | | R4 | 130 | 142 | | | XPGDWT-H1-0000-00GE8 | |
| | | R3 | 122 | 133 | | | XPGDWT-H1-0000-00FE8 | |
| | | R2 | 114 | 124 | | | | XPGDWT-U1-0000-00EE8 |
| | | Q5 | 107 | 117 | | | | XPGDWT-U1-0000-00DE8 |
| | | Q4 | 100 | 109 | | | | XPGDWT-U1-0000-00CE8 |
| EA | 2200 K | R3 | 122 | 133 | | XPGDWT-B1-0000-00FEA | | |
| | | R2 | 114 | 124 | | XPGDWT-B1-0000-00EEA | | |

Notes

- Cree maintains a tolerance of $\pm 7\%$ on flux and power measurements, ± 0.005 on chromaticity (CCx, CCy) measurements and a tolerance of ± 2 on CRI measurements. See the Measurements section (page 40).
- Cree XLamp XP-G3 LED order codes specify only a minimum flux bin and not a maximum. Cree may ship reels in flux bins higher than the minimum specified by the order code without advance notice. Shipments will always adhere to the chromaticity bin restrictions specified by the order code.
- * Flux values @ 25 °C are calculated and for reference only.

FLUX CHARACTERISTICS - WHITE (S LINE) - $T_j = 85\text{ }^\circ\text{C}$

The following table provides order codes for XLamp XP-G3 White (S Line) LEDs. For a complete description of the order code nomenclature, please see the Bin and Order Code Formats section (page 38). For definitions of the chromaticity kits, please see the Cree's Standard Chromaticity Kits section (page 37).

| Chromaticity | | Minimum Luminous Flux (lm) @ 350 mA | | | Order Codes |
|--------------|--------|-------------------------------------|-------------------|--------------------|----------------------|
| Kit | CCT | Code | Flux (lm) @ 85 °C | Flux (lm) @ 25 °C* | 70 CRI Minimum |
| E1 | 6500 K | S4 | 164 | 179 | XPGDWT-BS-0000-00LE1 |
| | | S3 | 156 | 170 | XPGDWT-BS-0000-00KE1 |
| DV | 6000 K | S5 | 172 | 187 | XPGDWT-BS-0000-00MDV |
| | | S4 | 164 | 179 | XPGDWT-BS-0000-00LDV |
| | | S3 | 156 | 170 | XPGDWT-BS-0000-00KDV |
| 50 | 6000 K | S4 | 164 | 179 | XPGDWT-BS-0000-00L50 |
| | | S3 | 156 | 170 | XPGDWT-BS-0000-00K50 |
| E2 | 5700 K | S5 | 172 | 187 | XPGDWT-BS-0000-00ME2 |
| | | S4 | 164 | 179 | XPGDWT-BS-0000-00LE2 |
| | | S3 | 156 | 170 | XPGDWT-BS-0000-00KE2 |
| 2E | 5700 K | S5 | 172 | 187 | XPGDWT-BS-0000-00M2E |
| | | S4 | 164 | 179 | XPGDWT-BS-0000-00L2E |
| | | S3 | 156 | 170 | XPGDWT-BS-0000-00K2E |
| 3E | 5000 K | S6 | 180 | 196 | XPGDWT-BS-0000-00N3E |
| | | S5 | 172 | 187 | XPGDWT-BS-0000-00M3E |
| | | S4 | 164 | 179 | XPGDWT-BS-0000-00L3E |
| E3 | 5000 K | S6 | 180 | 196 | XPGDWT-BS-0000-00NE3 |
| | | S5 | 172 | 187 | XPGDWT-BS-0000-00ME3 |
| | | S4 | 164 | 179 | XPGDWT-BS-0000-00LE3 |
| 4E | 4500K | S6 | 180 | 196 | XPGDWT-BS-0000-00N4E |
| | | S5 | 172 | 187 | XPGDWT-BS-0000-00M4E |
| | | S4 | 164 | 179 | XPGDWT-BS-0000-00L4E |
| E4 | 4500 K | S6 | 180 | 196 | XPGDWT-BS-0000-00NE4 |
| | | S5 | 172 | 187 | XPGDWT-BS-0000-00ME4 |
| | | S4 | 164 | 179 | XPGDWT-BS-0000-00LE4 |

Notes

- Cree maintains a tolerance of $\pm 7\%$ on flux and power measurements, ± 0.005 on chromaticity (CCx, CCy) measurements and a tolerance of ± 2 on CRI measurements. See the Measurements section (page 40).
- Cree XLamp XP-G3 LED order codes specify only a minimum flux bin and not a maximum. Cree may ship reels in flux bins higher than the minimum specified by the order code without advance notice. Shipments will always adhere to the chromaticity bin restrictions specified by the order code.
- * Flux values @ 25 °C are calculated and for reference only.

FLUX CHARACTERISTICS - WHITE (S LINE) - $T_j = 85\text{ }^\circ\text{C}$ (CONTINUED)

| Chromaticity | | Minimum Luminous Flux (lm) @ 350 mA | | | Order Codes |
|--------------|--------|-------------------------------------|-------------------|--------------------|----------------------|
| Kit | CCT | Code | Flux (lm) @ 85 °C | Flux (lm) @ 25 °C* | 70 CRI Minimum |
| 5E | 4000 K | S6 | 180 | 196 | XPGDWT-BS-0000-00N5E |
| | | S5 | 172 | 187 | XPGDWT-BS-0000-00M5E |
| | | S4 | 164 | 179 | XPGDWT-BS-0000-00L5E |
| E5 | 4000 K | S6 | 180 | 196 | XPGDWT-BS-0000-00NE5 |
| | | S5 | 172 | 187 | XPGDWT-BS-0000-00ME5 |
| | | S4 | 164 | 179 | XPGDWT-BS-0000-00LE5 |
| 6E | 3500 K | S4 | 164 | 179 | XPGDWT-BS-0000-00L6E |
| | | S3 | 156 | 170 | XPGDWT-BS-0000-00K6E |
| | | S2 | 148 | 161 | XPGDWT-BS-0000-00J6E |
| E6 | 3500 K | S4 | 164 | 179 | XPGDWT-BS-0000-00LE6 |
| | | S3 | 156 | 170 | XPGDWT-BS-0000-00KE6 |
| | | S2 | 148 | 161 | XPGDWT-BS-0000-00JE6 |
| F7 | 3200K | S4 | 164 | 179 | XPGDWT-BS-0000-00LF7 |
| | | S3 | 156 | 170 | XPGDWT-BS-0000-00KF7 |
| | | S2 | 148 | 161 | XPGDWT-BS-0000-00JF7 |
| 7E | 3000 K | S4 | 164 | 179 | XPGDWT-BS-0000-00L7E |
| | | S3 | 156 | 170 | XPGDWT-BS-0000-00K7E |
| | | S2 | 148 | 161 | XPGDWT-BS-0000-00J7E |
| E7 | 3000 K | S4 | 164 | 179 | XPGDWT-BS-0000-00LE7 |
| | | S3 | 156 | 170 | XPGDWT-BS-0000-00KE7 |
| | | S2 | 148 | 161 | XPGDWT-BS-0000-00JE7 |

Notes

- Cree maintains a tolerance of $\pm 7\%$ on flux and power measurements, ± 0.005 on chromaticity (CCx, CCy) measurements and a tolerance of ± 2 on CRI measurements. See the Measurements section (page 40).
- Cree XLamp XP-G3 LED order codes specify only a minimum flux bin and not a maximum. Cree may ship reels in flux bins higher than the minimum specified by the order code without advance notice. Shipments will always adhere to the chromaticity bin restrictions specified by the order code.
- * Flux values @ 25 °C are calculated and for reference only.

FLUX CHARACTERISTICS - COLOR ($T_j = 25\text{ }^\circ\text{C}$)

The following table provides the order code for XLamp XP-G3 color LEDs. For a complete description of the order code nomenclature, please see the Bin and Order Code Formats section (page 38).

| | PWL Kit Code | Peak Wavelength Range | | | | Typical Dominant Wavelength (nm) @ 350 mA, $T_j=25\text{ }^\circ\text{C}$ | Minimum Radiant Flux (mW) @ 350 mA, | | Calculated Minimum PPF ($\mu\text{mol/s}$) @ 350 mA, $25\text{ }^\circ\text{C}$ | Order Code |
|------------|--------------|-----------------------|----------|---------|----------|---|-------------------------------------|--------------------------------|---|----------------------|
| | | Minimum | | Maximum | | | Code | Flux (mW) @25 $^\circ\text{C}$ | | |
| | | Group | PWL (nm) | Group | PWL (nm) | | | | | |
| Royal Blue | 01 | H26 | 440 | H47 | 455 | 451 | E4 | 635 | 2.41 | XPGDRY-L1-0000-00401 |
| | | | | | | 451 | F2 | 680 | 2.58 | XPGDRY-L1-0000-00501 |
| | | | | | | 451 | F4 | 730 | 2.77 | XPGDRY-L1-0000-00601 |

| | PWL Kit Code | Peak Wavelength Range | | | | Typical Dominant Wavelength (nm) @ 350 mA, $T_j=25\text{ }^\circ\text{C}$ | Minimum Radiant Flux (mW) @ 350 mA, | | Calculated Minimum PPF ($\mu\text{mol/s}$) @ 350 mA, $25\text{ }^\circ\text{C}$ | Order Code |
|-----------|--------------|-----------------------|----------|---------|----------|---|-------------------------------------|--------------------------------|---|----------------------|
| | | Minimum | | Maximum | | | Code | Flux (mW) @25 $^\circ\text{C}$ | | |
| | | Group | PWL (nm) | Group | PWL (nm) | | | | | |
| Photo Red | 01 | P2 | 650 | P5 | 670 | 645 | 31 | 475 | 2.61 | XPGDPR-L1-0000-00E01 |
| | | P2 | 650 | P5 | 670 | 645 | 32 | 500 | 2.75 | XPGDPR-L1-0000-00F01 |
| | | P2 | 650 | P5 | 670 | 645 | 33 | 525 | 2.88 | XPGDPR-L1-0000-00G01 |

Notes

- Cree maintains a tolerance of $\pm 7\%$ on flux and power measurements, ± 0.005 on chromaticity (CCx, CCy) measurements and a tolerance of ± 2 on CRI measurements. See the Measurements section (page 40).
- Cree XLamp XP-G3 LED order codes specify only a minimum flux bin and not a maximum. Cree may ship reels in flux bins higher than the minimum specified by the order code without advance notice. Shipments will always adhere to the chromaticity bin restrictions specified by the order code.
- Dominant wavelengths are calculated based on peak wavelength specifications and are for reference only.
- Calculated Photosynthetic Photon Flux (PPF) values are for reference only.

RELATIVE SPECTRAL POWER DISTRIBUTION - WHITE (STANDARD)



RELATIVE SPECTRAL POWER DISTRIBUTION - WHITE (S LINE)



RELATIVE SPECTRAL POWER DISTRIBUTION - COLOR



RELATIVE FLUX VS. JUNCTION TEMPERATURE - WHITE (STANDARD) - $I_F = 350$ mA



RELATIVE FLUX VS. JUNCTION TEMPERATURE - WHITE (S LINE) - $I_F = 350$ mA



RELATIVE FLUX VS. JUNCTION TEMPERATURE - COLOR - $I_F = 350$ mA



ELECTRICAL CHARACTERISTICS - WHITE (STANDARD) - $T_j = 85\text{ }^\circ\text{C}$



ELECTRICAL CHARACTERISTICS - WHITE (S LINE) - $T_j = 85\text{ }^\circ\text{C}$

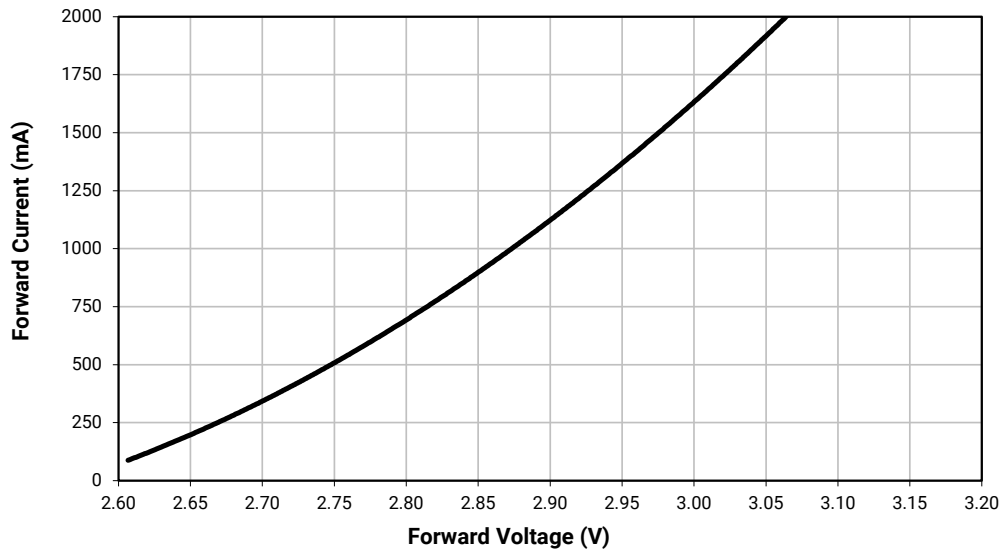

ELECTRICAL CHARACTERISTICS - COLOR ($T_j = 25\text{ }^\circ\text{C}$)

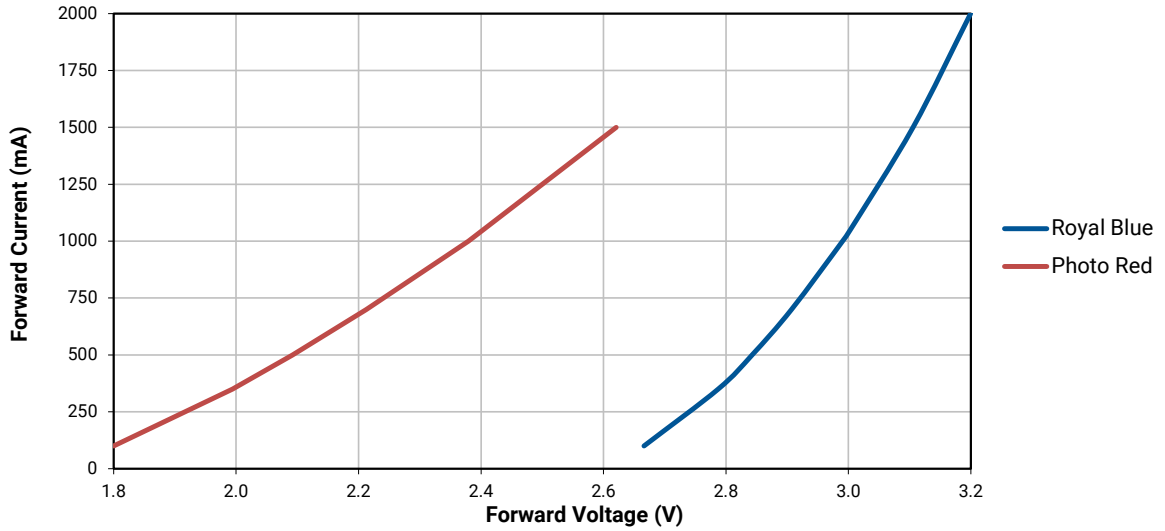

RELATIVE LUMINOUS FLUX VS. CURRENT - WHITE (STANDARD) - $T_j = 85\text{ }^\circ\text{C}$



RELATIVE LUMINOUS FLUX VS. CURRENT - WHITE (S LINE) - $T_j = 85\text{ }^\circ\text{C}$



RELATIVE RADIANT FLUX VS. CURRENT - COLOR ($T_j = 25\text{ }^\circ\text{C}$)



RELATIVE CHROMATICITY VS. CURRENT AND TEMPERATURE

Data shown is representative of typical XP-G3 70 CRI performance.



TYPICAL SPATIAL DISTRIBUTION - WHITE (STANDARD)

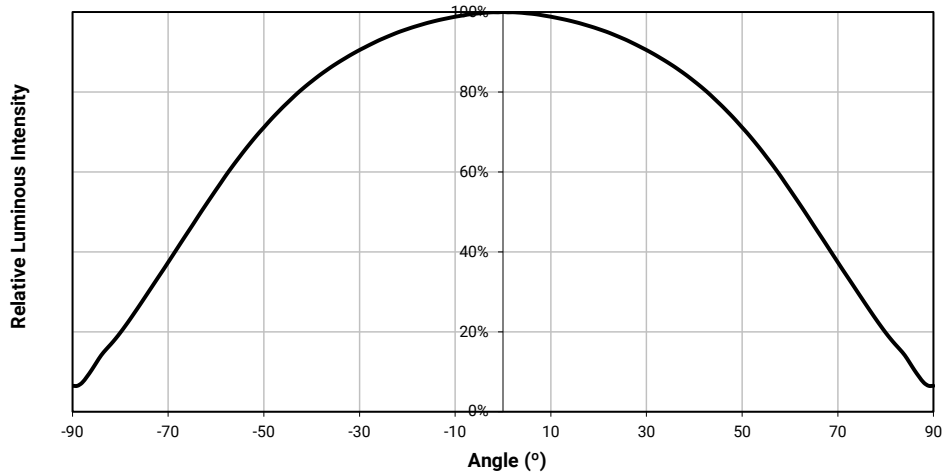

TYPICAL SPATIAL DISTRIBUTION - WHITE (S LINE)



TYPICAL SPATIAL DISTRIBUTION - COLOR

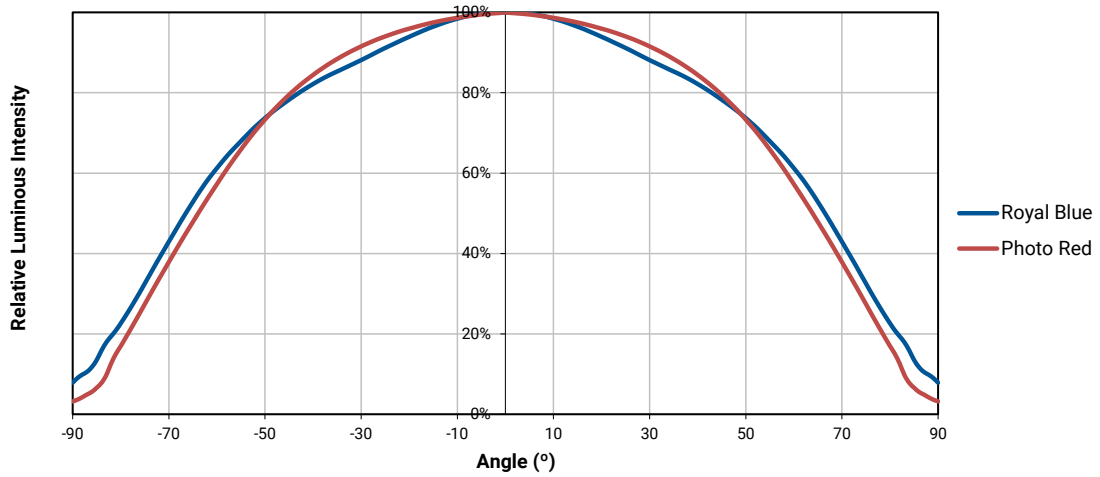

THERMAL DESIGN

The maximum forward current is determined by the thermal resistance between the LED junction and ambient. It is crucial for the end product to be designed in a manner that minimizes the thermal resistance from the solder point to ambient in order to optimize lamp life and optical characteristics.

White (Standard)



White (S Line)



Royal Blue



Photo Red



PERFORMANCE GROUPS - LUMINOUS FLUX

XLamp XP-G3 white (Standard) and XP-G3 white (S Line) LEDs are tested for luminous flux and placed into one of the following luminous-flux groups.

| Group Code | Minimum Luminous Flux (lm) @ 350 mA | Maximum Luminous Flux (lm) @ 350 mA |
|------------|--|--|
| Q4 | 100 | 107 |
| Q5 | 107 | 114 |
| R2 | 114 | 122 |
| R3 | 122 | 130 |
| R4 | 130 | 139 |
| R5 | 139 | 148 |
| S2 | 148 | 156 |
| S3 | 156 | 164 |
| S4 | 164 | 172 |
| S5 | 172 | 180 |
| S6 | 180 | 188 |
| S7 | 188 | 196 |

PERFORMANCE GROUPS - RADIANT FLUX (T_j = 25 °C)

XLamp XP-G3 royal blue LEDs are tested for radiant flux and placed into one of the following bins.

| Group Code | Minimum Radiant Flux (mW) | Maximum Radiant Flux (mW) | Calculated PPF (μmol/s) | |
|------------|---------------------------|---------------------------|-------------------------|---------|
| | | | Minimum | Maximum |
| E4 | 635 | 680 | 2.41 | 2.58 |
| F2 | 680 | 730 | 2.58 | 2.77 |
| F4 | 730 | 780 | 2.77 | 2.96 |

XLamp XP-G3 photo red LEDs are tested for radiant flux and placed into one of the following bins.

| Group Code | Minimum Radiant Flux (mW) | Maximum Radiant Flux (mW) | Calculated PPF (μmol/s) | |
|------------|---------------------------|---------------------------|-------------------------|---------|
| | | | Minimum | Maximum |
| 31 | 475 | 500 | 2.60 | 2.74 |
| 32 | 500 | 525 | 2.74 | 2.90 |
| 33 | 525 | 550 | 2.90 | 3.03 |

Note

- Calculated PPF values are for reference only.

PERFORMANCE GROUPS - PEAK WAVELENGTH ($T_j = 25\text{ }^\circ\text{C}$)

XLamp XP-G3 royal blue LEDs are tested for peak wavelength and sorted into one of the PWL bins defined below.

| Group Code | Minimum Peak Wavelength (nm) | Maximum Peak Wavelength (nm) | Typical Dominant Wavelength (nm) |
|------------|------------------------------|------------------------------|----------------------------------|
| H26 | 440.0 | 442.5 | 446.5 |
| H27 | 442.5 | 445.0 | 449.0 |
| H36 | 445.0 | 447.5 | 451.5 |
| H37 | 447.5 | 450.0 | 454.0 |
| H46 | 450.0 | 452.5 | 456.5 |
| H47 | 452.5 | 455.0 | 459.0 |

XLamp XP-G3 photo red LEDs are tested for peak wavelength and sorted into one of the PWL bins defined below.

| Group Code | Minimum Peak Wavelength (nm) | Maximum Peak Wavelength (nm) | Typical Dominant Wavelength (nm) |
|------------|------------------------------|------------------------------|----------------------------------|
| P2 | 650 | 655 | 638 |
| P3 | 655 | 660 | 643 |
| P4 | 660 | 665 | 647 |
| P5 | 665 | 670 | 652 |

Note

- Typical dominant wavelength values are calculated and for reference only.

PERFORMANCE GROUPS - FORWARD VOLTAGE

XLamp XP-G3 photo red LEDs are tested for forward voltage and sorted into one of the forward voltage bins defined below.

| Forward Voltage Group | Minimum Forward Voltage (V) @ 350 mA | Maximum Forward Voltage (V) @ 350 mA |
|-----------------------|--------------------------------------|--------------------------------------|
| W | 1.8 | 1.9 |
| X | 1.9 | 2.0 |
| Y | 2.0 | 2.1 |
| Z | 2.1 | 2.2 |

PERFORMANCE GROUPS - CHROMATICITY

| Region | x | y | Region | x | y | Region | x | y | Region | x | y |
|--------|--------|--------|--------|--------|--------|--------|--------|--------|--------|--------|--------|
| 0A | 0.2950 | 0.2970 | 0B | 0.2920 | 0.3060 | 0C | 0.2984 | 0.3133 | 0D | 0.2984 | 0.3133 |
| | 0.2920 | 0.3060 | | 0.2895 | 0.3135 | | 0.2962 | 0.3220 | | 0.3048 | 0.3207 |
| | 0.2984 | 0.3133 | | 0.2962 | 0.3220 | | 0.3028 | 0.3304 | | 0.3068 | 0.3113 |
| | 0.3009 | 0.3042 | | 0.2984 | 0.3133 | | 0.3048 | 0.3207 | | 0.3009 | 0.3042 |
| 0R | 0.2980 | 0.2880 | 0S | 0.2895 | 0.3135 | 0T | 0.2962 | 0.3220 | 0U | 0.3037 | 0.2937 |
| | 0.2950 | 0.2970 | | 0.2870 | 0.3210 | | 0.2937 | 0.3312 | | 0.3009 | 0.3042 |
| | 0.3009 | 0.3042 | | 0.2937 | 0.3312 | | 0.3005 | 0.3415 | | 0.3068 | 0.3113 |
| | 0.3037 | 0.2937 | | 0.2962 | 0.3220 | | 0.3028 | 0.3304 | | 0.3093 | 0.2993 |
| 1A | 0.3048 | 0.3207 | 1B | 0.3028 | 0.3304 | 1C | 0.3115 | 0.3391 | 1D | 0.3130 | 0.3290 |
| | 0.3130 | 0.3290 | | 0.3115 | 0.3391 | | 0.3205 | 0.3481 | | 0.3213 | 0.3373 |
| | 0.3144 | 0.3186 | | 0.3130 | 0.3290 | | 0.3213 | 0.3373 | | 0.3221 | 0.3261 |
| | 0.3068 | 0.3113 | | 0.3048 | 0.3207 | | 0.3130 | 0.3290 | | 0.3144 | 0.3186 |
| 1R | 0.3068 | 0.3113 | 1S | 0.3005 | 0.3415 | 1T | 0.3099 | 0.3509 | 1U | 0.3144 | 0.3186 |
| | 0.3144 | 0.3186 | | 0.3099 | 0.3509 | | 0.3196 | 0.3602 | | 0.3221 | 0.3261 |
| | 0.3161 | 0.3059 | | 0.3115 | 0.3391 | | 0.3205 | 0.3481 | | 0.3231 | 0.3120 |
| | 0.3093 | 0.2993 | | 0.3028 | 0.3304 | | 0.3115 | 0.3391 | | 0.3161 | 0.3059 |
| 2A | 0.3215 | 0.3350 | 2B | 0.3207 | 0.3462 | 2C | 0.3290 | 0.3538 | 2D | 0.3290 | 0.3417 |
| | 0.3290 | 0.3417 | | 0.3290 | 0.3538 | | 0.3376 | 0.3616 | | 0.3371 | 0.3490 |
| | 0.3290 | 0.3300 | | 0.3290 | 0.3417 | | 0.3371 | 0.3490 | | 0.3366 | 0.3369 |
| | 0.3222 | 0.3243 | | 0.3215 | 0.3350 | | 0.3290 | 0.3417 | | 0.3290 | 0.3300 |
| 2R | 0.3222 | 0.3243 | 2S | 0.3196 | 0.3602 | 2T | 0.3290 | 0.3690 | 2U | 0.3290 | 0.3300 |
| | 0.3290 | 0.3300 | | 0.3290 | 0.3690 | | 0.3381 | 0.3762 | | 0.3366 | 0.3369 |
| | 0.3290 | 0.3180 | | 0.3290 | 0.3538 | | 0.3376 | 0.3616 | | 0.3361 | 0.3245 |
| | 0.3231 | 0.3120 | | 0.3207 | 0.3462 | | 0.3290 | 0.3538 | | 0.3290 | 0.3180 |
| 3A | 0.3371 | 0.3490 | 3B | 0.3376 | 0.3616 | 3C | 0.3463 | 0.3687 | 3D | 0.3451 | 0.3554 |
| | 0.3451 | 0.3554 | | 0.3463 | 0.3687 | | 0.3551 | 0.3760 | | 0.3533 | 0.3620 |
| | 0.3440 | 0.3427 | | 0.3451 | 0.3554 | | 0.3533 | 0.3620 | | 0.3515 | 0.3487 |
| | 0.3366 | 0.3369 | | 0.3371 | 0.3490 | | 0.3451 | 0.3554 | | 0.3440 | 0.3427 |
| 3R | 0.3366 | 0.3369 | 3S | 0.3381 | 0.3762 | | | | | | |
| | 0.3440 | 0.3428 | | 0.3480 | 0.3840 | | | | | | |
| | 0.3429 | 0.3307 | | 0.3463 | 0.3687 | | | | | | |
| | 0.3361 | 0.3245 | | 0.3376 | 0.3616 | | | | | | |
| 4A | 0.3530 | 0.3597 | 4B | 0.3548 | 0.3736 | 4C | 0.3641 | 0.3804 | 4D | 0.3615 | 0.3659 |
| | 0.3615 | 0.3659 | | 0.3641 | 0.3804 | | 0.3736 | 0.3874 | | 0.3702 | 0.3722 |
| | 0.3590 | 0.3521 | | 0.3615 | 0.3659 | | 0.3702 | 0.3722 | | 0.3670 | 0.3578 |
| | 0.3512 | 0.3465 | | 0.3530 | 0.3597 | | 0.3615 | 0.3659 | | 0.3590 | 0.3521 |

PERFORMANCE GROUPS - CHROMATICITY (CONTINUED)

| Region | x | y | Region | x | y | Region | x | y | Region | x | y |
|--------|--------|--------|--------|--------|--------|--------|--------|--------|--------|--------|--------|
| 5A1 | 0.3670 | 0.3578 | 5A2 | 0.3686 | 0.3649 | 5A3 | 0.3744 | 0.3685 | 5A4 | 0.3726 | 0.3612 |
| | 0.3686 | 0.3649 | | 0.3702 | 0.3722 | | 0.3763 | 0.3760 | | 0.3744 | 0.3685 |
| | 0.3744 | 0.3685 | | 0.3763 | 0.3760 | | 0.3825 | 0.3798 | | 0.3804 | 0.3721 |
| | 0.3726 | 0.3612 | | 0.3744 | 0.3685 | | 0.3804 | 0.3721 | | 0.3783 | 0.3646 |
| 5B1 | 0.3702 | 0.3722 | 5B2 | 0.3719 | 0.3797 | 5B3 | 0.3782 | 0.3837 | 5B4 | 0.3763 | 0.3760 |
| | 0.3719 | 0.3797 | | 0.3736 | 0.3874 | | 0.3802 | 0.3916 | | 0.3782 | 0.3837 |
| | 0.3782 | 0.3837 | | 0.3802 | 0.3916 | | 0.3869 | 0.3958 | | 0.3847 | 0.3877 |
| | 0.3763 | 0.3760 | | 0.3782 | 0.3837 | | 0.3847 | 0.3877 | | 0.3825 | 0.3798 |
| 5C1 | 0.3825 | 0.3798 | 5C2 | 0.3847 | 0.3877 | 5C3 | 0.3912 | 0.3917 | 5C4 | 0.3887 | 0.3836 |
| | 0.3847 | 0.3877 | | 0.3869 | 0.3958 | | 0.3937 | 0.4001 | | 0.3912 | 0.3917 |
| | 0.3912 | 0.3917 | | 0.3937 | 0.4001 | | 0.4006 | 0.4044 | | 0.3978 | 0.3958 |
| | 0.3887 | 0.3836 | | 0.3912 | 0.3917 | | 0.3978 | 0.3958 | | 0.3950 | 0.3875 |
| 5D1 | 0.3783 | 0.3646 | 5D2 | 0.3804 | 0.3721 | 5D3 | 0.3863 | 0.3758 | 5D4 | 0.3840 | 0.3681 |
| | 0.3804 | 0.3721 | | 0.3825 | 0.3798 | | 0.3887 | 0.3836 | | 0.3863 | 0.3758 |
| | 0.3863 | 0.3758 | | 0.3887 | 0.3836 | | 0.3950 | 0.3875 | | 0.3924 | 0.3794 |
| | 0.3840 | 0.3681 | | 0.3863 | 0.3758 | | 0.3924 | 0.3794 | | 0.3898 | 0.3716 |
| 6A1 | 0.3889 | 0.3690 | 6A2 | 0.3915 | 0.3768 | 6A3 | 0.3981 | 0.3800 | 6A4 | 0.3953 | 0.3720 |
| | 0.3915 | 0.3768 | | 0.3941 | 0.3848 | | 0.4010 | 0.3882 | | 0.3981 | 0.3800 |
| | 0.3981 | 0.3800 | | 0.4010 | 0.3882 | | 0.4080 | 0.3916 | | 0.4048 | 0.3832 |
| | 0.3953 | 0.3720 | | 0.3981 | 0.3800 | | 0.4048 | 0.3832 | | 0.4017 | 0.3751 |
| 6B1 | 0.3941 | 0.3848 | 6B2 | 0.3968 | 0.3930 | 6B3 | 0.4040 | 0.3966 | 6B4 | 0.4010 | 0.3882 |
| | 0.3968 | 0.3930 | | 0.3996 | 0.4015 | | 0.4071 | 0.4052 | | 0.4040 | 0.3966 |
| | 0.4040 | 0.3966 | | 0.4071 | 0.4052 | | 0.4146 | 0.4089 | | 0.4113 | 0.4001 |
| | 0.4010 | 0.3882 | | 0.4040 | 0.3966 | | 0.4113 | 0.4001 | | 0.4080 | 0.3916 |
| 6C1 | 0.4080 | 0.3916 | 6C2 | 0.4113 | 0.4001 | 6C3 | 0.4186 | 0.4037 | 6C4 | 0.4150 | 0.3950 |
| | 0.4113 | 0.4001 | | 0.4146 | 0.4089 | | 0.4222 | 0.4127 | | 0.4186 | 0.4037 |
| | 0.4186 | 0.4037 | | 0.4222 | 0.4127 | | 0.4299 | 0.4165 | | 0.4259 | 0.4073 |
| | 0.4150 | 0.3950 | | 0.4186 | 0.4037 | | 0.4259 | 0.4073 | | 0.4221 | 0.3984 |
| 6D1 | 0.4017 | 0.3751 | 6D2 | 0.4048 | 0.3832 | 6D3 | 0.4116 | 0.3865 | 6D4 | 0.4082 | 0.3782 |
| | 0.4048 | 0.3832 | | 0.4080 | 0.3916 | | 0.4150 | 0.3950 | | 0.4116 | 0.3865 |
| | 0.4116 | 0.3865 | | 0.4150 | 0.3950 | | 0.4221 | 0.3984 | | 0.4183 | 0.3898 |
| | 0.4082 | 0.3782 | | 0.4116 | 0.3865 | | 0.4183 | 0.3898 | | 0.4147 | 0.3814 |
| 7A1 | 0.4147 | 0.3814 | 7A2 | 0.4183 | 0.3898 | 7A3 | 0.4242 | 0.3919 | 7A4 | 0.4203 | 0.3833 |
| | 0.4183 | 0.3898 | | 0.4221 | 0.3984 | | 0.4281 | 0.4006 | | 0.4242 | 0.3919 |
| | 0.4242 | 0.3919 | | 0.4281 | 0.4006 | | 0.4342 | 0.4028 | | 0.4300 | 0.3939 |
| | 0.4203 | 0.3833 | | 0.4242 | 0.3919 | | 0.4300 | 0.3939 | | 0.4259 | 0.3853 |

PERFORMANCE GROUPS - CHROMATICITY (CONTINUED)

| Region | x | y | Region | x | y | Region | x | y | Region | x | y |
|--------|--------|--------|--------|--------|--------|--------|--------|--------|--------|--------|--------|
| 7B1 | 0.4221 | 0.3984 | 7B2 | 0.4259 | 0.4073 | 7B3 | 0.4322 | 0.4096 | 7B4 | 0.4281 | 0.4006 |
| | 0.4259 | 0.4073 | | 0.4299 | 0.4165 | | 0.4364 | 0.4188 | | 0.4322 | 0.4096 |
| | 0.4322 | 0.4096 | | 0.4364 | 0.4188 | | 0.4430 | 0.4212 | | 0.4385 | 0.4119 |
| | 0.4281 | 0.4006 | | 0.4322 | 0.4096 | | 0.4385 | 0.4119 | | 0.4342 | 0.4028 |
| 7C1 | 0.4342 | 0.4028 | 7C2 | 0.4385 | 0.4119 | 7C3 | 0.4449 | 0.4141 | 7C4 | 0.4403 | 0.4049 |
| | 0.4385 | 0.4119 | | 0.4430 | 0.4212 | | 0.4496 | 0.4236 | | 0.4449 | 0.4141 |
| | 0.4449 | 0.4141 | | 0.4496 | 0.4236 | | 0.4562 | 0.4260 | | 0.4513 | 0.4164 |
| | 0.4403 | 0.4049 | | 0.4449 | 0.4141 | | 0.4513 | 0.4164 | | 0.4465 | 0.4071 |
| 7D1 | 0.4259 | 0.3853 | 7D2 | 0.4300 | 0.3939 | 7D3 | 0.4359 | 0.3960 | 7D4 | 0.4316 | 0.3873 |
| | 0.4300 | 0.3939 | | 0.4342 | 0.4028 | | 0.4403 | 0.4049 | | 0.4359 | 0.3960 |
| | 0.4359 | 0.3960 | | 0.4403 | 0.4049 | | 0.4465 | 0.4071 | | 0.4418 | 0.3981 |
| | 0.4316 | 0.3873 | | 0.4359 | 0.3960 | | 0.4418 | 0.3981 | | 0.4373 | 0.3893 |
| 8A1 | 0.4373 | 0.3893 | 8A2 | 0.4418 | 0.3981 | 8A3 | 0.4475 | 0.3994 | 8A4 | 0.4428 | 0.3906 |
| | 0.4418 | 0.3981 | | 0.4465 | 0.4071 | | 0.4523 | 0.4085 | | 0.4475 | 0.3994 |
| | 0.4475 | 0.3994 | | 0.4523 | 0.4085 | | 0.4582 | 0.4099 | | 0.4532 | 0.4008 |
| | 0.4428 | 0.3906 | | 0.4475 | 0.3994 | | 0.4532 | 0.4008 | | 0.4483 | 0.3919 |
| 8B1 | 0.4465 | 0.4071 | 8B2 | 0.4513 | 0.4164 | 8B3 | 0.4573 | 0.4178 | 8B4 | 0.4523 | 0.4085 |
| | 0.4513 | 0.4164 | | 0.4562 | 0.4260 | | 0.4624 | 0.4274 | | 0.4573 | 0.4178 |
| | 0.4573 | 0.4178 | | 0.4624 | 0.4274 | | 0.4687 | 0.4289 | | 0.4634 | 0.4193 |
| | 0.4523 | 0.4085 | | 0.4573 | 0.4178 | | 0.4634 | 0.4193 | | 0.4582 | 0.4099 |
| 8C1 | 0.4582 | 0.4099 | 8C2 | 0.4634 | 0.4193 | 8C3 | 0.4695 | 0.4207 | 8C4 | 0.4641 | 0.4112 |
| | 0.4634 | 0.4193 | | 0.4687 | 0.4289 | | 0.4750 | 0.4304 | | 0.4695 | 0.4207 |
| | 0.4695 | 0.4207 | | 0.4750 | 0.4304 | | 0.4813 | 0.4319 | | 0.4756 | 0.4221 |
| | 0.4641 | 0.4112 | | 0.4695 | 0.4207 | | 0.4756 | 0.4221 | | 0.4700 | 0.4126 |
| 8D1 | 0.4483 | 0.3919 | 8D2 | 0.4532 | 0.4008 | 8D3 | 0.4589 | 0.4021 | 8D4 | 0.4538 | 0.3931 |
| | 0.4532 | 0.4008 | | 0.4582 | 0.4099 | | 0.4641 | 0.4112 | | 0.4589 | 0.4021 |
| | 0.4589 | 0.4021 | | 0.4641 | 0.4112 | | 0.4700 | 0.4126 | | 0.4646 | 0.4034 |
| | 0.4538 | 0.3931 | | 0.4589 | 0.4021 | | 0.4646 | 0.4034 | | 0.4593 | 0.3944 |
| AA1 | 0.4822 | 0.3973 | AA2 | 0.4884 | 0.4067 | AA3 | 0.4942 | 0.4066 | AA4 | 0.4879 | 0.3972 |
| | 0.4884 | 0.4067 | | 0.4946 | 0.4162 | | 0.5006 | 0.4160 | | 0.4942 | 0.4066 |
| | 0.4942 | 0.4066 | | 0.5006 | 0.4160 | | 0.5066 | 0.4158 | | 0.5001 | 0.4064 |
| | 0.4879 | 0.3972 | | 0.4942 | 0.4066 | | 0.5001 | 0.4064 | | 0.4936 | 0.3970 |
| AB1 | 0.4946 | 0.4162 | AB2 | 0.5008 | 0.4256 | AB3 | 0.5069 | 0.4254 | AB4 | 0.5006 | 0.4160 |
| | 0.5008 | 0.4256 | | 0.5070 | 0.4350 | | 0.5133 | 0.4348 | | 0.5069 | 0.4254 |
| | 0.5069 | 0.4254 | | 0.5133 | 0.4348 | | 0.5196 | 0.4346 | | 0.5131 | 0.4252 |
| | 0.5006 | 0.4160 | | 0.5069 | 0.4254 | | 0.5131 | 0.4252 | | 0.5066 | 0.4158 |

PERFORMANCE GROUPS - CHROMATICITY (CONTINUED)

| Region | x | y | Region | x | y | Region | x | y | Region | x | y |
|--------|--------|--------|--------|--------|--------|--------|--------|--------|--------|--------|--------|
| AC1 | 0.5066 | 0.4158 | AC2 | 0.5131 | 0.4252 | AC3 | 0.5192 | 0.4250 | AC4 | 0.5126 | 0.4156 |
| | 0.5131 | 0.4252 | | 0.5196 | 0.4346 | | 0.5258 | 0.4343 | | 0.5192 | 0.4250 |
| | 0.5192 | 0.4250 | | 0.5258 | 0.4343 | | 0.5321 | 0.4341 | | 0.5253 | 0.4248 |
| | 0.5126 | 0.4156 | | 0.5192 | 0.4250 | | 0.5253 | 0.4248 | | 0.5186 | 0.4154 |
| AD1 | 0.4936 | 0.3970 | AD2 | 0.5001 | 0.4064 | AD3 | 0.5059 | 0.4062 | AD4 | 0.4993 | 0.3969 |
| | 0.5001 | 0.4064 | | 0.5066 | 0.4158 | | 0.5126 | 0.4156 | | 0.5059 | 0.4062 |
| | 0.5059 | 0.4062 | | 0.5126 | 0.4156 | | 0.5186 | 0.4154 | | 0.5118 | 0.4061 |
| | 0.4993 | 0.3969 | | 0.5059 | 0.4062 | | 0.5118 | 0.4061 | | 0.5050 | 0.3967 |

XLamp XP-G3 white (Standard) and XP-G3 white (S Line) LEDs are tested for chromaticity and placed into one of the regions defined by the following bounding coordinates.

| EasyWhite Color Temperatures – 3-Step Ellipse | | | | | | |
|---|--------|--------------|--------|------------|------------|--------------------|
| Bin Code | CCT | Center Point | | Major Axis | Minor Axis | Rotation Angle (°) |
| | | x | y | a | b | |
| 6G | 3500 K | 0.4073 | 0.3917 | 0.00927 | 0.00414 | 53.2 |
| 7G | 3000 K | 0.4338 | 0.4030 | 0.00834 | 0.00408 | 53.2 |
| 8G | 2700 K | 0.4577 | 0.4099 | 0.00834 | 0.00420 | 48.5 |

| EasyWhite Color Temperatures – 5-Step Ellipse | | | | | | |
|---|--------|--------------|--------|------------|------------|--------------------|
| Bin Code | CCT | Center Point | | Major Axis | Minor Axis | Rotation Angle (°) |
| | | x | y | a | b | |
| 2E | 5700 K | 0.3287 | 0.3417 | 0.01230 | 0.00600 | 72.0 |
| 3E | 5000 K | 0.3447 | 0.3553 | 0.01400 | 0.00520 | 65.0 |
| 4E | 4500 K | 0.3611 | 0.3658 | 0.01420 | 0.00550 | 61.5 |
| 5E | 4000 K | 0.3818 | 0.3797 | 0.01565 | 0.00670 | 53.7 |
| 6E | 3500 K | 0.4073 | 0.3917 | 0.01545 | 0.00690 | 54.0 |
| 7E | 3000 K | 0.4338 | 0.4030 | 0.01390 | 0.00680 | 53.2 |
| 8E | 2700 K | 0.4577 | 0.4099 | 0.01350 | 0.00700 | 48.5 |

CREE'S STANDARD CHROMATICITY REGIONS PLOTTED ON THE 1931 CIE CURVE

ANSI Cool White



Neutral White

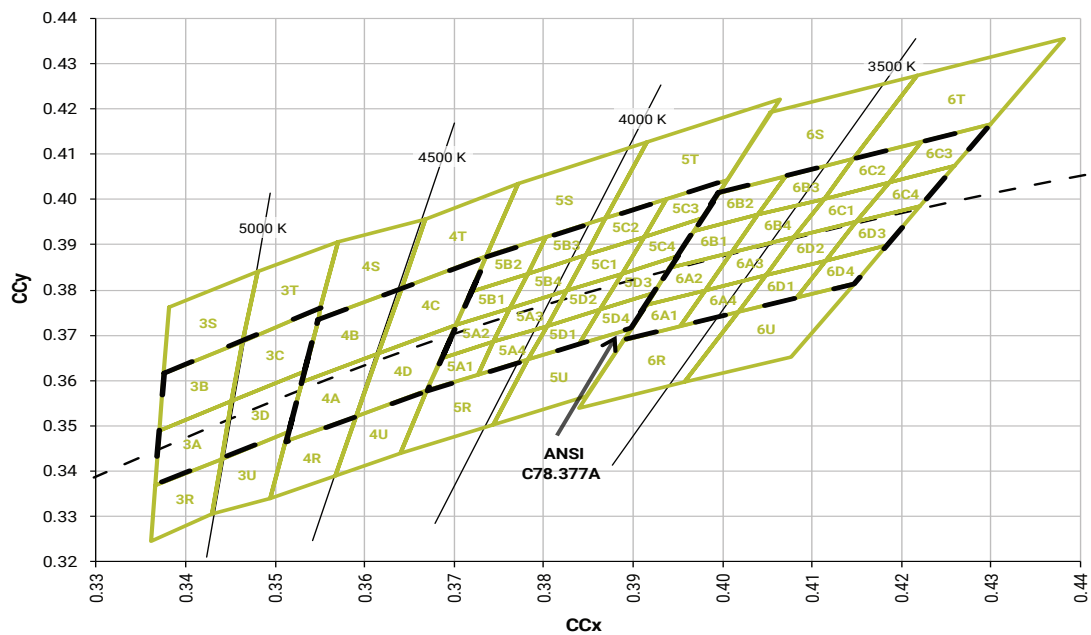

CREE'S STANDARD CHROMATICITY REGIONS PLOTTED ON THE 1931 CIE CURVE - CONTINUED

ANSI Neutral White and ANSI Warm White

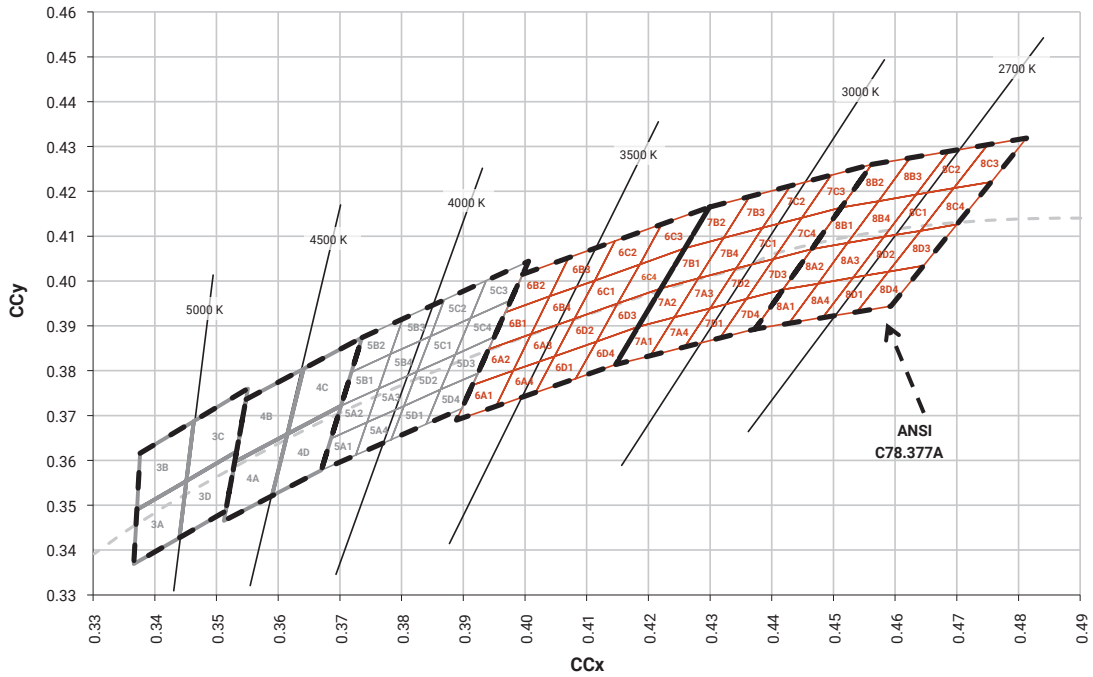

CREE'S STANDARD COOL WHITE KITS PLOTTED ON ANSI STANDARD CHROMATICITY REGIONS



CREE'S STANDARD WARM AND NEUTRAL WHITE KITS PLOTTED ON ANSI STANDARD CHROMATICITY REGIONS



CREE'S STANDARD WARM AND NEUTRAL WHITE KITS PLOTTED ON ANSI STANDARD CHROMATICITY REGIONS - CONTINUED

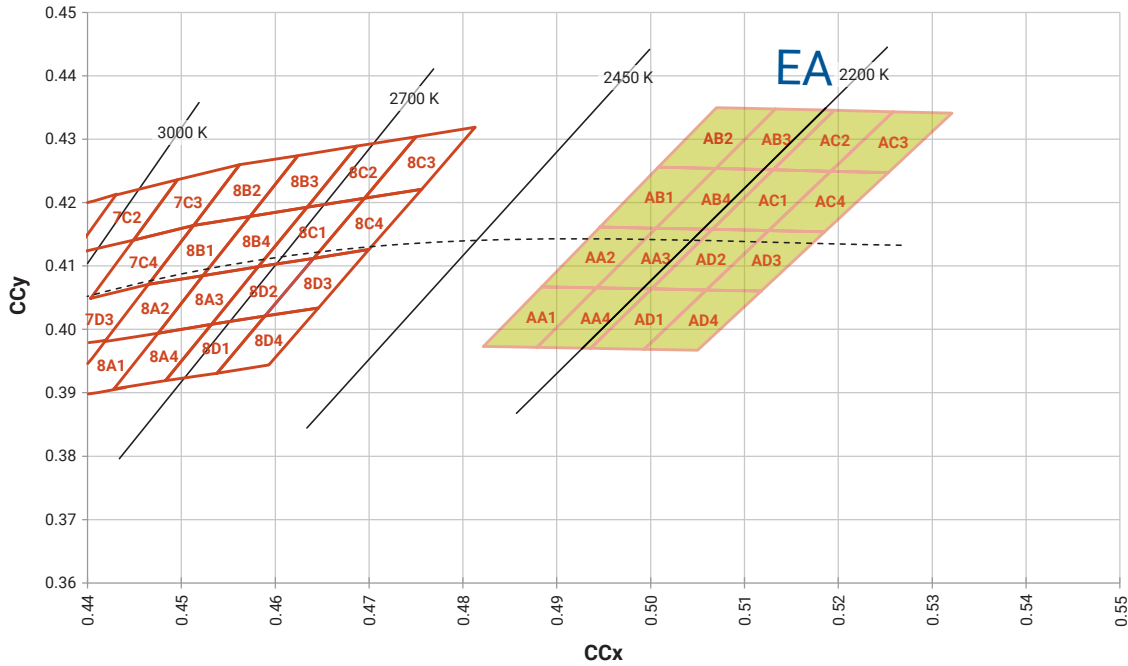

CREE'S EASYWHITE® WHITE KITS PLOTTED ON ANSI STANDARD CHROMATICITY REGIONS

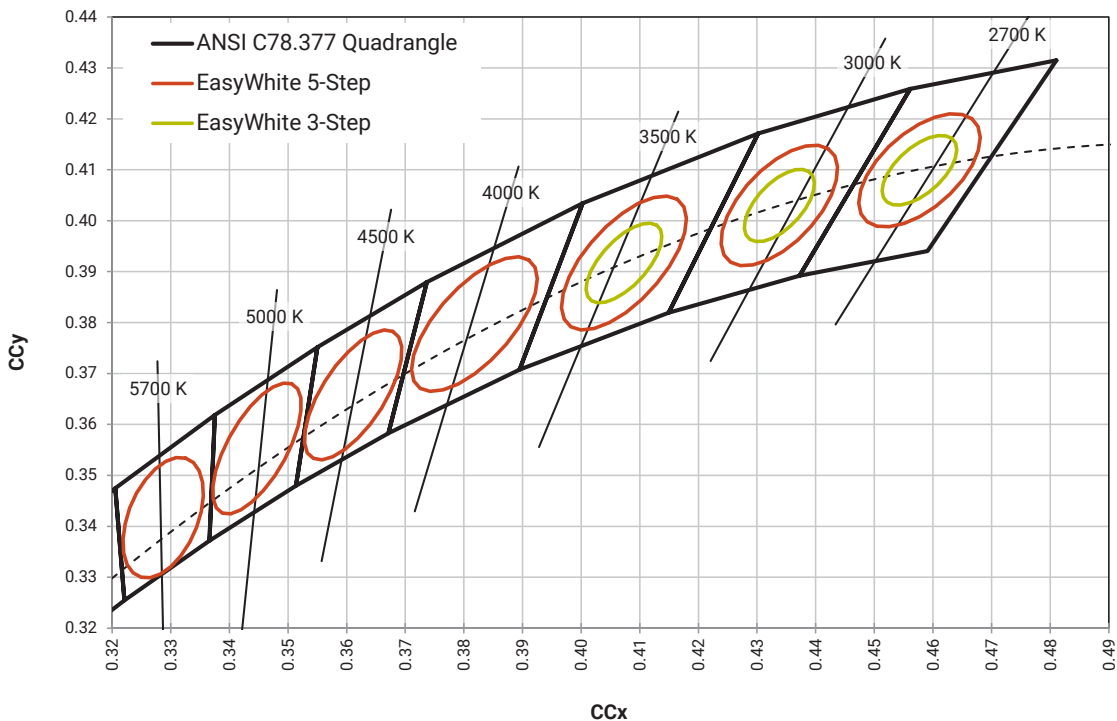

CREE'S STANDARD CHROMATICITY KITS

The following table provides the chromaticity bins associated with chromaticity kits.

| Color | CCT | Kit | Chromaticity Bins |
|---------------|---------|-----|--|
| Cool White | 7000 K | DT | 0A, 0B, 0C, 0D, 0R, 0S, 0T, 0U, 1A, 1B, 1C, 1D, 1R, 1S, 1T, 1U |
| | 6500 K | CB | 0A, 0B, 0C, 0D, 0R, 0S, 0T, 0U, 1A, 1B, 1C, 1D, 1R, 1S, 1T, 1U, 2A, 2B, 2C, 2D, 2R, 2S, 2T, 2U |
| | >6500 K | E0 | 0A, 0B, 0C, 0D |
| | 6500 K | E1 | 1A, 1B, 1C, 1D |
| | 6000 K | DV | 1A, 1B, 1C, 1D, 1R, 1S, 1T, 1U, 2A, 2B, 2C, 2D, 2R, 2S, 2T, 2U |
| | 6200 K | 50 | 1A, 1B, 1C, 1D, 2A, 2B, 2C, 2D |
| | 5700 K | E2 | 2A, 2B, 2C, 2D |
| | 5700 K | 2E | 57E |
| Neutral White | 5000 K | 3E | 50E |
| | 5000 K | E3 | 3A, 3B, 3C, 3D |
| | 4750 K | F4 | 3C, 3D, 4A, 4B |
| | 4500 K | 4E | 45E |
| | 4500 K | E4 | 4A, 4B, 4C, 4D |
| | 4250 K | F5 | 4C, 4D, 5A1, 5A2, 5A3, 5A4, 5B1, 5B2, 5B3, 5B4 |
| | 4000 K | 5E | 40E |
| | 4000 K | E5 | 5A1, 5A2, 5A3, 5A4, 5B1, 5B2, 5B3, 5B4, 5C1, 5C2, 5C3, 5C4, 5D1, 5D2, 5D3, 5D4 |
| Warm White | 3750 K | F6 | 5C1, 5C2, 5C3, 5C4, 5D1, 5D2, 5D3, 5D4, 6A1, 6A2, 6A3, 6A4, 6B1, 6B2, 6B3, 6B4 |
| | 3500 K | 6E | 35E, 35G |
| | 3500 K | 6G | 35G |
| | 3500 K | E6 | 6A1, 6A2, 6A3, 6A4, 6B1, 6B2, 6B3, 6B4, 6C1, 6C2, 6C3, 6C4, 6D1, 6D2, 6D3, 6D4 |
| | 3250 K | F7 | 6C1, 6C2, 6C3, 6C4, 6D1, 6D2, 6D3, 6D4, 7A1, 7A2, 7A3, 7A4, 7B1, 7B2, 7B3, 7B4 |
| | 3000 K | 7E | 30E, 30G |
| | 3000 K | 7G | 30G |
| | 3000 K | E7 | 7A1, 7A2, 7A3, 7A4, 7B1, 7B2, 7B3, 7B4, 7C1, 7C2, 7C3, 7C4, 7D1, 7D2, 7D3, 7D4 |
| | 2850 K | F8 | 7C1, 7C2, 7C3, 7C4, 7D1, 7D2, 7D3, 7D4, 8A1, 8A2, 8A3, 8A4, 8B1, 8B2, 8B3, 8B4 |
| | 2700 K | 8E | 27E, 27G |
| | 2700 K | 8G | 27G |
| | 2700 K | E8 | 8A1, 8A2, 8A3, 8A4, 8B1, 8B2, 8B3, 8B4, 8C1, 8C2, 8C3, 8C4, 8D1, 8D2, 8D3, 8D4 |
| | 2200 K | EA | AA1, AA2, AA3, AA4, AB1, AB2, AB3, AB4, AC1, AC2, AC3, AC4, AD1, AD2, AD3, AD4 |

BIN AND ORDER CODE FORMATS

XP-G3 bin codes and order codes are configured in the following manner:



REFLOW SOLDERING CHARACTERISTICS

In testing, Cree has found XLamp XP-G3 LEDs to be compatible with JEDEC J-STD-020C, with the exception of the peak temperature requirements listed in the table below. As a general guideline, Cree recommends that users follow the recommended soldering profile provided by the manufacturer of the solder paste used, and therefore it is the lamp or luminaire manufacturer’s responsibility to determine applicable soldering requirements.

Note that this general guideline may not apply to all PCB designs and configurations of reflow soldering equipment.



| Profile Feature | Lead-Free Solder |
|---|------------------|
| Average Ramp-Up Rate ($T_{s_{max}}$ to T_p) | 1.2 °C/second |
| Preheat: Temperature Min ($T_{s_{min}}$) | 120 °C |
| Preheat: Temperature Max ($T_{s_{max}}$) | 170 °C |
| Preheat: Time ($t_{s_{min}}$ to $t_{s_{max}}$) | 65-150 seconds |
| Time Maintained Above: Temperature (T_L) | 217 °C |
| Time Maintained Above: Time (t_L) | 45-90 seconds |
| Peak/Classification Temperature (T_p) | 235 - 245 °C |
| Time Within 5 °C of Actual Peak Temperature (t_p) | 20-40 seconds |
| Ramp-Down Rate | 1 - 6 °C/second |
| Time 25 °C to Peak Temperature | 4 minutes max. |

Note: All temperatures refer to topside of the package, measured on the package body surface.

NOTES

Measurements

The luminous flux, radiant power, chromaticity, forward voltage and CRI measurements in this document are binning specifications only and solely represent product measurements as of the date of shipment. These measurements will change over time based on a number of factors that are not within Cree's control and are not intended or provided as operational specifications for the products. Calculated values are provided for informational purposes only and are not intended or provided as specifications.

Pre-Release Qualification Testing

Please read the [LED Reliability Overview](#) for details of the qualification process Cree applies to ensure long-term reliability for XLamp LEDs and details of Cree's pre-release qualification testing for XLamp LEDs. Cree did not perform Room Temperature Operating Life (RTOL) testing on the XP-G3 LED.

Lumen Maintenance

Cree now uses standardized IES LM-80-08 and TM-21-11 methods for collecting long-term data and extrapolating LED lumen maintenance. For information on the specific LM-80 data sets available for this LED, refer to the public [LM-80 results document](#).

Please read the [Long-Term Lumen Maintenance application note](#) for more details on Cree's lumen maintenance testing and forecasting. Please read the [Thermal Management application note](#) for details on how thermal design, ambient temperature, and drive current affect the LED junction temperature.

Moisture Sensitivity

Cree recommends keeping XLamp LEDs in the provided, resealable moisture-barrier packaging (MBP) until immediately prior to soldering. Unopened MBPs that contain XLamp LEDs do not need special storage for moisture sensitivity.

Once the MBP is opened, XLamp XP-G3 LEDs may be stored as MSL 1 per JEDEC J-STD-033, meaning they have unlimited floor life in conditions of ≤ 30 °C/85% relative humidity (RH). Regardless of the storage condition, Cree recommends sealing any unsoldered LEDs in the original MBP.

RoHS Compliance

The levels of RoHS restricted materials in this product are below the maximum concentration values (also referred to as the threshold limits) permitted for such substances, or are used in an exempted application, in accordance with EU Directive 2011/65/EC (RoHS2), as implemented January 2, 2013. RoHS Declarations for this product can be obtained from your Cree representative or from the [Product Ecology](#) section of the Cree website.

REACH Compliance

REACH substances of very high concern (SVHCs) information is available for this product. Since the European Chemical Agency (ECHA) has published notice of their intent to frequently revise the SVHC listing for the foreseeable future, please contact a Cree representative to insure you get the most up-to-date REACH Declaration. REACH banned substance information (REACH Article 67) is also available upon request.

NOTES - CONTINUED

UL® Recognized Component

This product meets the requirements to be considered a UL Recognized Component with Level 4 enclosure consideration. The LED package or a portion thereof has been investigated as a fire and electrical enclosure per ANSI/UL 8750.

Vision Advisory

WARNING: Do not look at an exposed lamp in operation. Eye injury can result. For more information about LEDs and eye safety, please refer to the [LED Eye Safety application note](#).

MECHANICAL DIMENSIONS ($T_A = 25\text{ }^\circ\text{C}$)

Thermal vias, if present, are not shown on these drawings.

All measurements are $\pm .13\text{ mm}$ unless otherwise indicated.

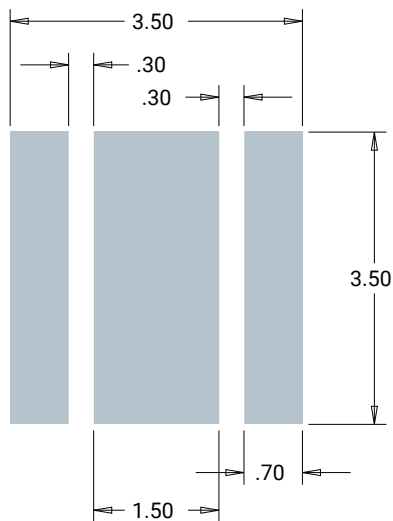
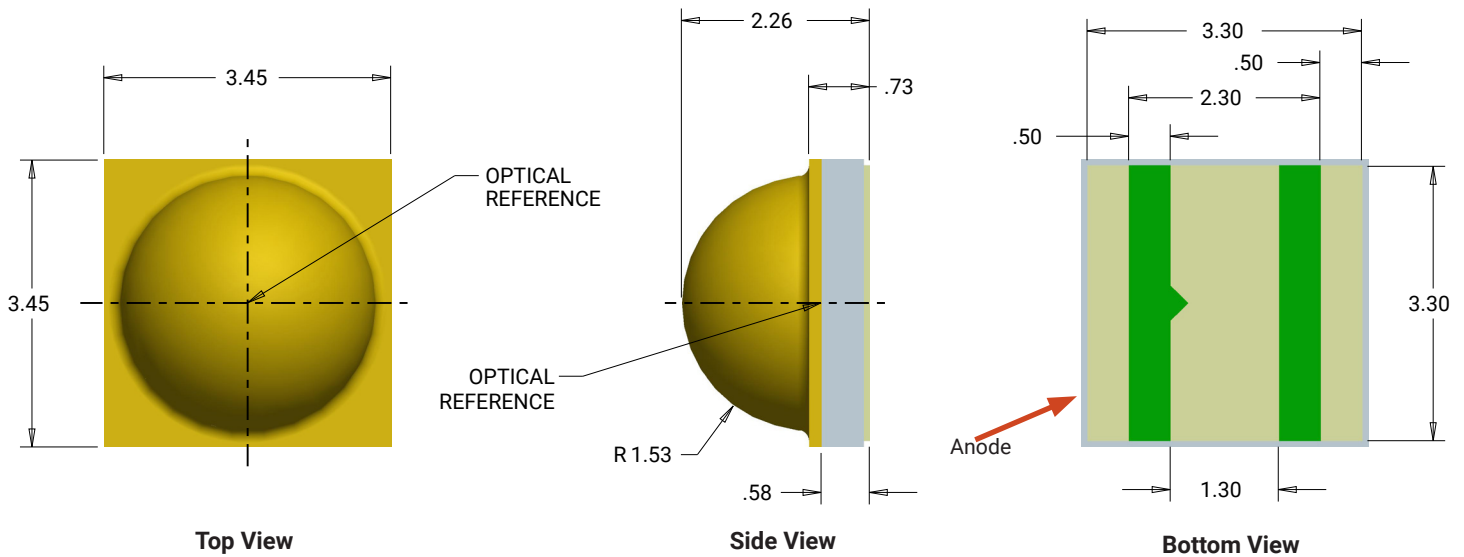

Recommended Copper Layout

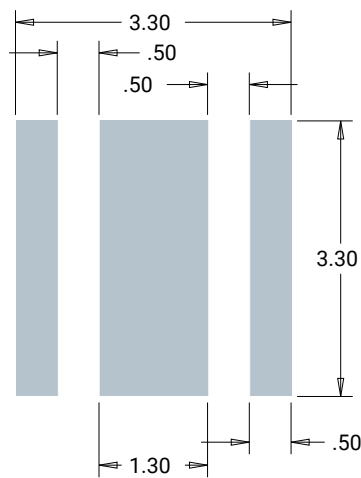

**Recommended Solder Pad
(Solder Mask Pattern)**

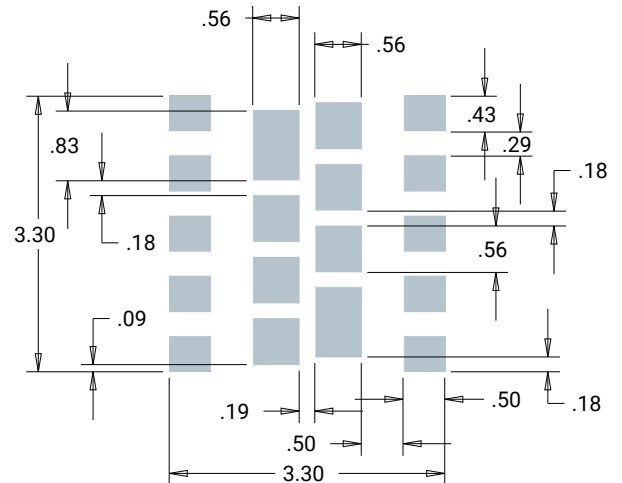

Recommended Stencil Openings*

Notes:

- Cree recommends using thermal pad kickouts to maximize component thermal performance.
- Cree recommends using white solder mask material to minimize system optical loss.
- * This stencil has been tested and optimized for the avoidance of voiding when using ALPHA® LUMET® P30 Maxrel solder paste. For other solder pastes, a “window pane” design for the thermal pad stencil may result in a lower voiding percentage. Contact your local Cree Field Applications Engineer for consultation regarding your specific application.

TAPE AND REEL

All Cree carrier tapes conform to EIA-481D, Automated Component Handling Systems Standard.

All dimensions in mm.



| | | |
|-----|-------|-----------|
| Ao | 3.70 | +/- 0.1 |
| Bo | 3.70 | +/- 0.1 |
| Ko | 2.40 | +0.0/-0.1 |
| F | 5.50 | +/- 0.05 |
| P 1 | 8.00 | +/- 0.1 |
| W | 12.00 | +0.3/-0.1 |

- (I) Measured from centerline of sprocket hole to centerline of pocket.
- (II) Cumulative tolerance of 10 sprocket holes is ±0.20.
- (III) Measured from centerline of sprocket hole to centerline of pocket.
- (IV) Other material available.



PACKAGING

Unpackaged Reel



Label with Cree Bin Code,
Quantity, Reel ID

Packaged Reel



Label with Cree Order Code,
Quantity, Reel ID, PO #

Label with Cree Bin Code,
Quantity, Reel ID

Boxed Reel



Label with Cree Order Code,
Quantity, Reel ID, PO #

Label with Cree Bin Code,
Quantity, Reel ID

Patent Label
(on bottom of box)



Компания «ЭлектроПласт» предлагает заключение долгосрочных отношений при поставках импортных электронных компонентов на взаимовыгодных условиях!

Наши преимущества:

- Оперативные поставки широкого спектра электронных компонентов отечественного и импортного производства напрямую от производителей и с крупнейших мировых складов;
- Поставка более 17-ти миллионов наименований электронных компонентов;
- Поставка сложных, дефицитных, либо снятых с производства позиций;
- Оперативные сроки поставки под заказ (от 5 рабочих дней);
- Экспресс доставка в любую точку России;
- Техническая поддержка проекта, помощь в подборе аналогов, поставка прототипов;
- Система менеджмента качества сертифицирована по Международному стандарту ISO 9001;
- Лицензия ФСБ на осуществление работ с использованием сведений, составляющих государственную тайну;
- Поставка специализированных компонентов (Xilinx, Altera, Analog Devices, Intersil, Interpoint, Microsemi, Aeroflex, Peregrine, Syfer, Eurofarad, Texas Instrument, Miteq, Cobham, E2V, MA-COM, Hittite, Mini-Circuits, General Dynamics и др.);

Помимо этого, одним из направлений компании «ЭлектроПласт» является направление «Источники питания». Мы предлагаем Вам помощь Конструкторского отдела:

- Подбор оптимального решения, техническое обоснование при выборе компонента;
- Подбор аналогов;
- Консультации по применению компонента;
- Поставка образцов и прототипов;
- Техническая поддержка проекта;
- Защита от снятия компонента с производства.



Как с нами связаться

Телефон: 8 (812) 309 58 32 (многоканальный)

Факс: 8 (812) 320-02-42

Электронная почта: org@eplast1.ru

Адрес: 198099, г. Санкт-Петербург, ул. Калинина, дом 2, корпус 4, литера А.