

ISP1302

Lite V4.2 Bluetooth Low Energy Module with MCU and Antenna

This ultra-small LGA module, 8 x 8 x 1 mm, is based on the nRF51822 Chip. Its powerful Cortex™ M0 CPU, flash and RAM memory combined with an optimized antenna offers the perfect solution for Bluetooth connectivity. The solution is best in class for RF performance and low power consumption. Multiple digital and analogue interfaces give optimum flexibility for sensor integration.

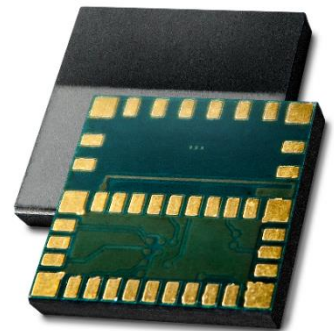

Key Features

- Single Mode BLE V4.2 Compliant
- IPv6 Connectivity
- ECDH Encryption
- Based on Nordic Semiconductor nRF51
- 2.4GHz low energy RF Transceiver
- 32bit ARM Cortex M0 CPU
- 128 kB or 256 kB Flash
- 16 kB SRAM
- 16 GPIOs including 5 ADC inputs & 1 ADC reference
- Ultra Low Power Consumption
- Single 1.8 to 3.6 V supply
- Very small size 8.0 x 8.0 x 1.0 mm
- Temperature -40 to +85 °C
- Fully integrated RF matching and Antenna
- Integrated 16 MHz Clock
- Possibility to connect external 32.768 kHz
- Possibility to enable DC-DC converter by adding external passive components

Applications

- High volume BLE applications
- Connected sensors for medical devices, healthcare, sport, fitness, industrial ...
- IoT applications, connected objects
- Wearable technology
- Home automation
- BLE connectivity for any existing application
- Beacons



Certifications

- Bluetooth SIG certified QDL listing
- Fully CE certified module
- Fully FCC certified module
- Fully IC certified module
- Fully IMOC certified module
- Fully TELEC certified module
- RoHS compliant

Contents

1.	Block Diagram	3
2.	Specifications	4
2.1.	Important Notice	4
2.2.	Absolute Maximum Ratings.....	4
2.3.	Operating Conditions	4
2.4.	Power Consumption.....	5
2.5.	Clock Sources.....	5
2.6.	Radio Specifications.....	5
2.7.	Electrical Schematic.....	8
3.	Pin Description	10
4.	Mechanical Outlines.....	12
4.1.	Mechanical Dimensions	12
4.2.	SMT Assembly Guidelines	13
4.3.	Antenna Keep-Out Zone	13
5.	Product Development Tools	14
5.1.	Hardware	14
5.2.	Firmware	14
5.3.	Development Tools	15
5.4.	Serialization API	15
6.	Reference Designs.....	16
6.1.	Sensor Board Design	16
6.2.	Beacon Design	17
7.	Packaging & Ordering information	18
7.1.	Marking.....	18
7.2.	Prototype Packaging.....	18
7.3.	Jedec Trays	18
7.4.	Tape and Reel	19
7.5.	Ordering Information	20
8.	Storage & Soldering information.....	21
8.1.	Storage and Handling	21
8.2.	Moisture Sensitivity	21
8.3.	Soldering information	22
9.	Quality & User information.....	23
9.1.	Certifications	23
9.2.	USA – User information	23
9.3.	Canada – User Information	23
9.4.	Discontinuity	24
9.5.	Disclaimer.....	24

1. Block Diagram

This module is based on nRF51822 Nordic Semiconductor 2.4GHz wireless System on Chip (SoC) integrating a 2.4 GHz transceiver, a 32-bit ARM Cortex™-M0 CPU, a flash memory, a RAM and analog and digital peripherals.

It can support BLE and a range of proprietary 2.4 GHz protocols, such as Gazell from Nordic Semiconductor. The ANT protocol can be handled on request.

Fully qualified BLE stacks for nRF51822 are implemented in the S100 series of SoftDevices which can be freely downloaded. ISP1302 can then be used in Central, Peripheral or both roles for BLE and for both ends of other proprietary protocols.

Ultra low power consumption and advanced power management enables battery lifetimes up to several years on a coin cell battery. Even though its very small size 8 x 8 x 1mm, the module integrates decoupling capacitors, 16 MHz crystal, RF matching circuit and antenna in addition to the wireless SoC. It is also possible to connect external DC-DC converter passive components and 32 kHz crystal.

Only the addition of a suitable DC power source is necessary for BLE connectivity. Sensor applications require the further addition of appropriate sensors. The antenna was designed to be optimized with several standard ground plane sizes.

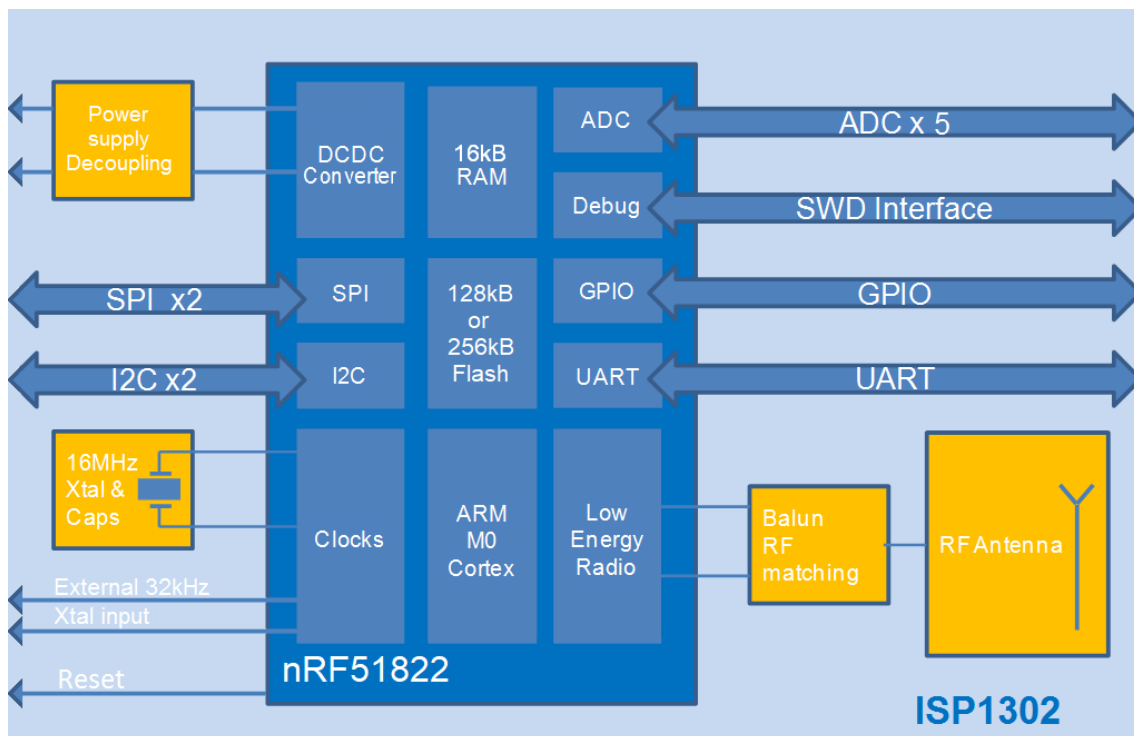

2. Specifications

2.1. Important Notice

The electrical specifications of the module are directly related to the Nordic Semiconductor specifications for the nRF51822 chipset. Bellow information is only a summary of the main parameters. For more detailed information, especially about current consumption, please refer to the up-to-date specification of the chipset available on Nordic Semi website.

2.2. Absolute Maximum Ratings

Parameter	Min	Typ	Max	Unit
Supply Voltage respect to ground - VCC	-0.3		3.9	V
IO Pin Voltage	-0.3		VCC + 0.3	V
Storage Temperature	-40		+125	°C
Moisture Sensitivity Level			5	-
ESD Human Body Model			4000	V
ESD Charged Device Model			500	V
Flash Endurance			20000	cycles

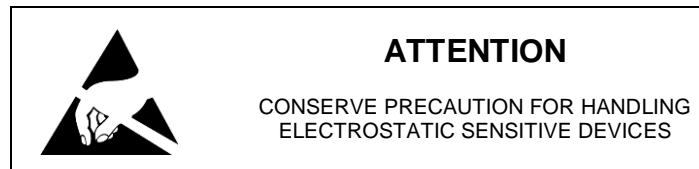

2.3. Operating Conditions

Parameter	Min	Typ	Max	Unit
Operating Supply Voltage, internal LDO setup	1.8 ⁽¹⁾ 1.9 ⁽²⁾	3.0	3.6	V
Operating Supply Voltage, DCDC converter setup	2.1	3.0	3.6	V
Extended Industrial Operating Temperature Range	-40	+25	+85	°C

(1) Minimum Supply Voltage Specification for Standard Operating Temperature Range -25°C to +75°C only

(2) Minimum Supply Voltage Specification for Extended Industrial Operating Temperature Range -40°C to +85°C

2.4. Power Consumption

Parameter	Min	Typ	Max	Unit
Peak current, Receiver active (supply at 2.1V)		12.6		mA
Peak current, Transmitter active +4 dBm Output Power		16		mA
Peak current, Transmitter active 0 dBm Output Power		10.5		mA
Current drain, Connection-less state, no RAM retention		0.6		μA
Current drain, Between connection events		2.6		μA

2.5. Clock Sources

Parameter	Min	Typ	Max	Unit
Internal High Frequency Clock for RF Stability: 16 MHz Crystal Frequency Tolerance ⁽¹⁾			+/- 40	ppm
Internal Low Frequency Clock for BLE Synchronization: RC Oscillator ⁽²⁾			+/- 250	ppm
RF Frequency tolerance: For BLE operation Channels 0 to 39			+/- 40	ppm

(1) including initial tolerance, drift, aging, and frequency pulling

(2) with calibration interval of 4 sec

2.6. Radio Specifications

Parameter	Min	Typ	Max	Unit
Frequency Range	2402		2480	Mhz
Channel 0 to 39 Spacing		2		Mhz
Output Power Channels 0 to 39	-20		+4	dBm
Rx sensitivity Level for BER <0,1% ideal Tx	-93			dBm
Antenna Gain		0.6		dBi
EIRP	-19.4		4.6	dBm
Range Open field @1m height		100		m
Data Rate	250 / 1000 / 2000			kbps

Typical Antenna Return Loss

Module mounted on a USB dongle ground plane

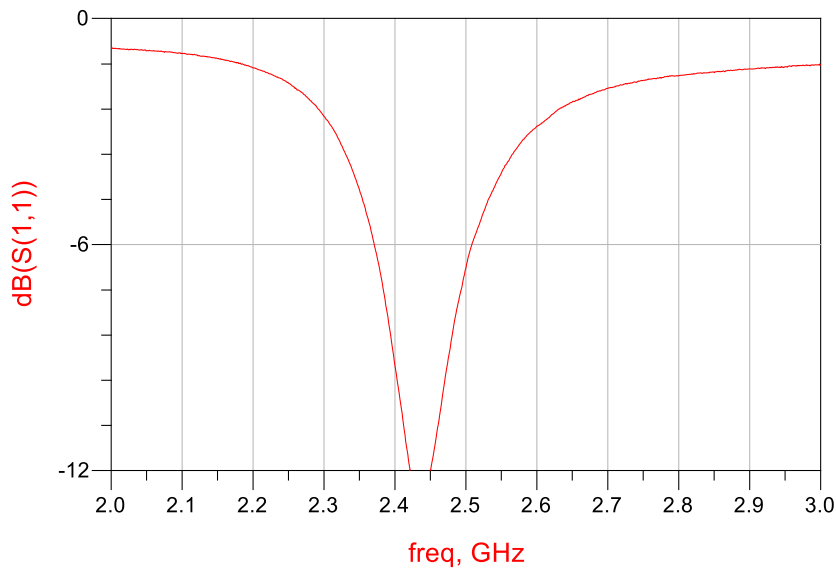

Radiation Pattern in 3 planes

Module mounted on a USB dongle ground plane

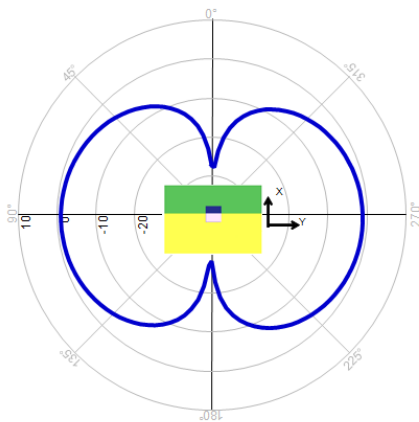
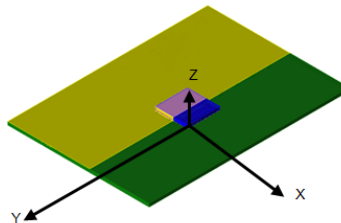

Phi (0.000 to 360.000)

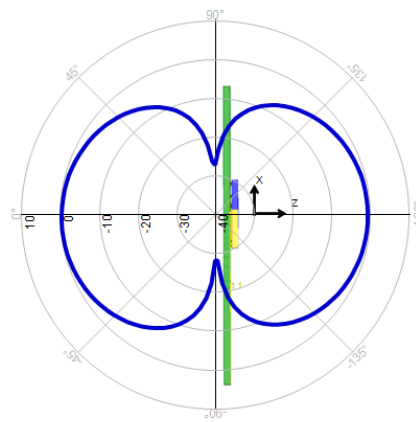

Thêta (-180.000 to 180.000)

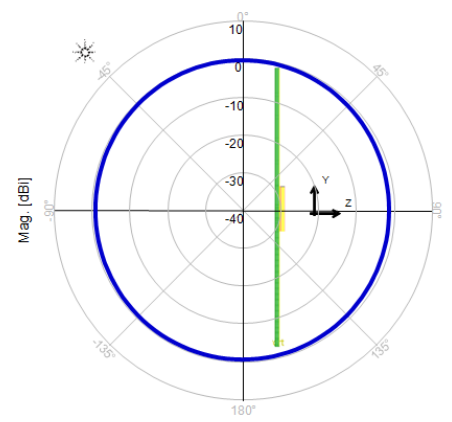

Thêta (-180.000 to 180.000)

Gain measurement in dBi @ 2.45 GHz

Ground Plane Effect Simulation

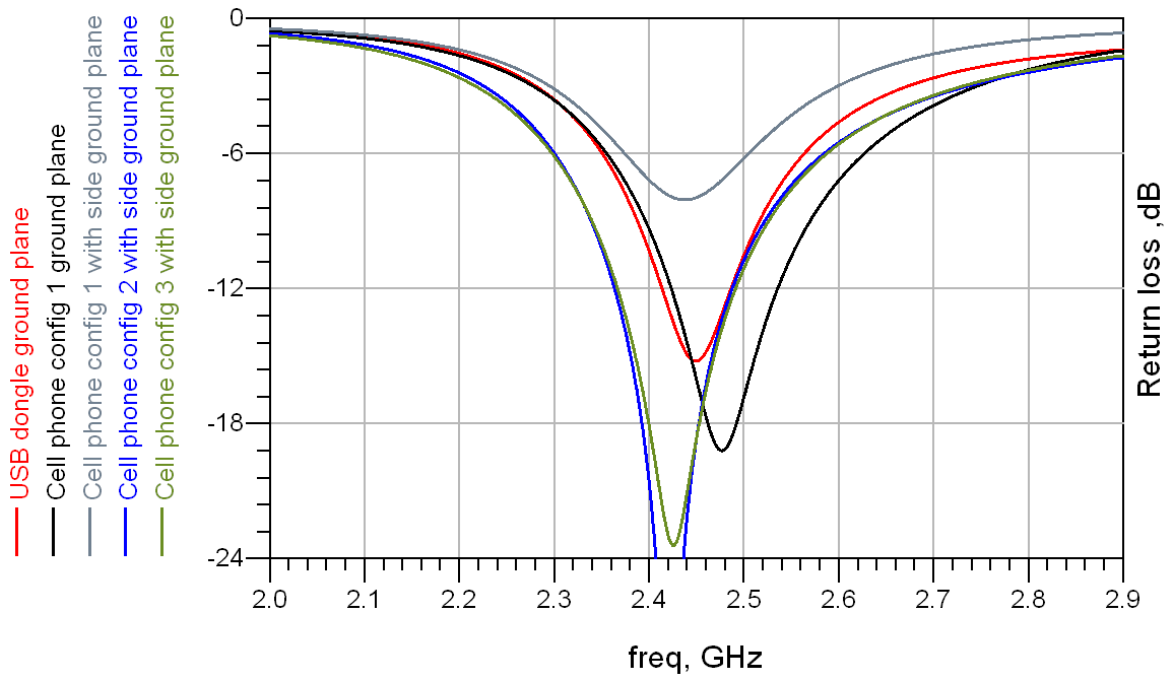
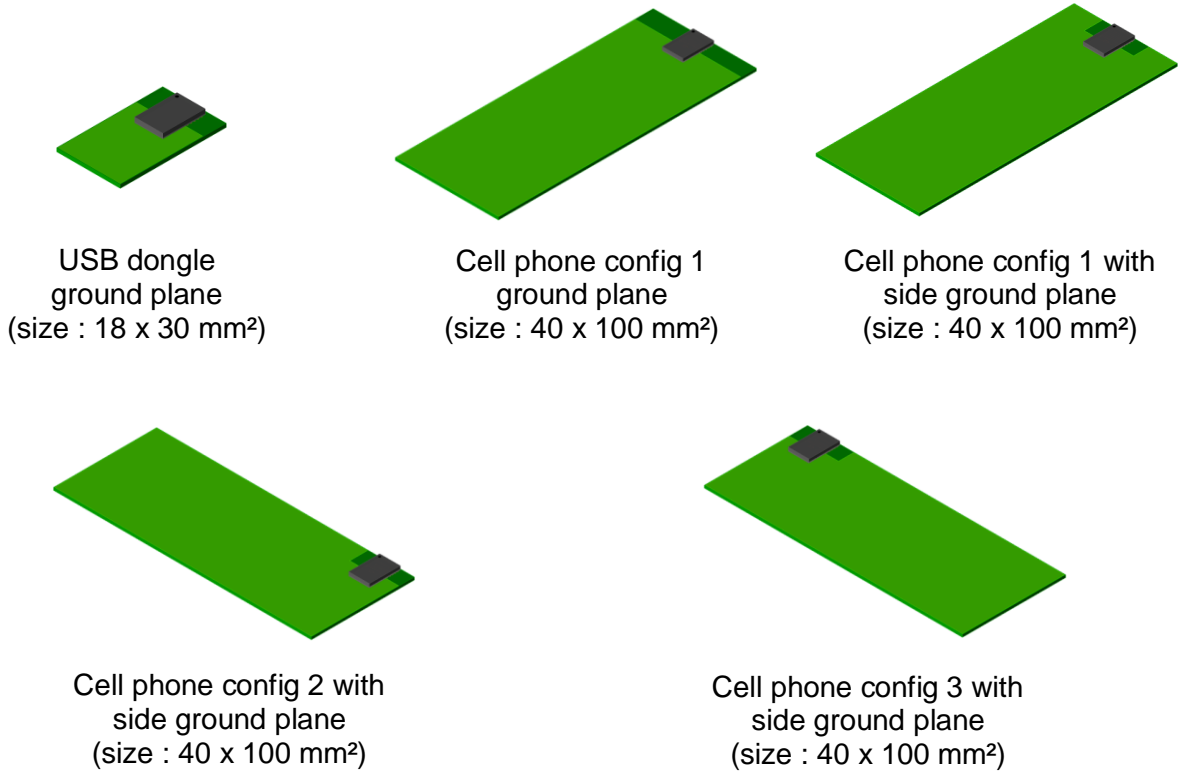

3. Pin Description

The module uses an LGA format with pads on a 0.65 mm pitch. The pad layout follows the QFN Jedec standard for LGA parts. The NC pads are to be connected to isolated metal pads on the application PCB for mechanical stability and reliability (drop test).

Pin	Name	Pin function	Description
1	VSS	Ground	Should be connected to ground plane on application PCB
2	P0_24	Digital I/O	General purpose I/O pin
3	P0_21	Digital I/O	General purpose I/O pin
4	P0_22	Digital I/O	General purpose I/O pin
5	VSS	Ground	Should be connected to ground plane on application PCB
6	OUT_ANT	Antenna I/O	This pin is connected to the internal antenna It should be connected to Pin 7 OUT_MOD for normal operation
7	OUT_MOD	Antenna I/O	This pin is the RF I/O pin of the BLE module It should be connected to Pin 6 OUT_ANT for normal operation
8	VSS	Ground	Should be connected to ground plane on application PCB
9	AVDD	Power	Should be connected to VCC in LDO mode, to 1.8V in low voltage mode; or should be connected to Pin 24 DCC through loading inductors and capacitors in DC/DC mode
10	P0_25	Digital I/O	General purpose I/O pin
11	P0_29	Digital I/O	General purpose I/O pin
12	P0_19	Digital I/O	General purpose I/O pin
13	P0_15	Digital I/O	General purpose I/O pin
14	P0_20	Digital I/O	General purpose I/O pin
15	VSS	Ground	Should be connected to ground plane on application PCB
16	SWDIO- nRESET	Digital I/O	System reset (active low). Also HW debug and flash programming I/O
17	P0_12	Digital I/O	General purpose I/O pin
18	SWDCLK	Digital Input	HW debug and flash programming I/O
19	VSS	Ground	Should be connected to ground plane on application PCB
20	P0_06 AIN7	Digital I/O Analog input	General purpose I/O pin ADC input
21	P0_03 AIN4	Digital I/O Analog input	General purpose I/O pin ADC input
22	P0_02 AIN3	Digital I/O Analog input	General purpose I/O pin ADC input
23	P0_00 AREF0	Digital I/O Analog input	General purpose I/O pin ADC Reference voltage
24	DCC	Power	Should not be connected in LDO or low voltage mode Should be connected to Pin 9 AVDD through loading inductors and capacitors in DC/DC mode
25	VCC_nRF	Power	Power supply (1.8 – 3.6V)

Pin	Name	Pin function	Description
26	P0_27 AIN1 XL1	Digital I/O Analog input Analog input	General purpose I/O pin ADC input Crystal connection for 32.768 kHz crystal oscillator or external 32.768 kHz crystal reference
27	P0_23	Digital I/O	General purpose I/O pin
28	P0_26 AIN0 XL2	Digital I/O Analog input Analog input	General purpose I/O pin ADC input Crystal connection for 32.768 kHz crystal oscillator
29 to 40	NC	Not Connected	Isolated pad for mechanical stability Do not connect

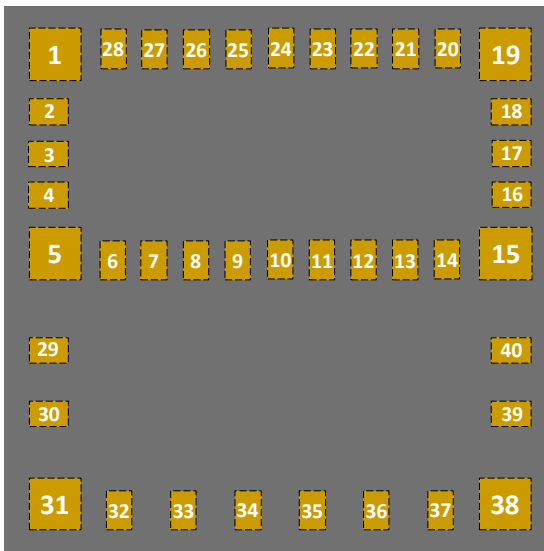

ISP1302 pad placement and pin assignment
for the LGA QFN package

TOP VIEW

4. Mechanical Outlines

4.1. Mechanical Dimensions

Dimensional drawing for 8 x 8 x 1 mm, 40-Pad LGA Package.

All dimensions in mm.

TOP VIEW

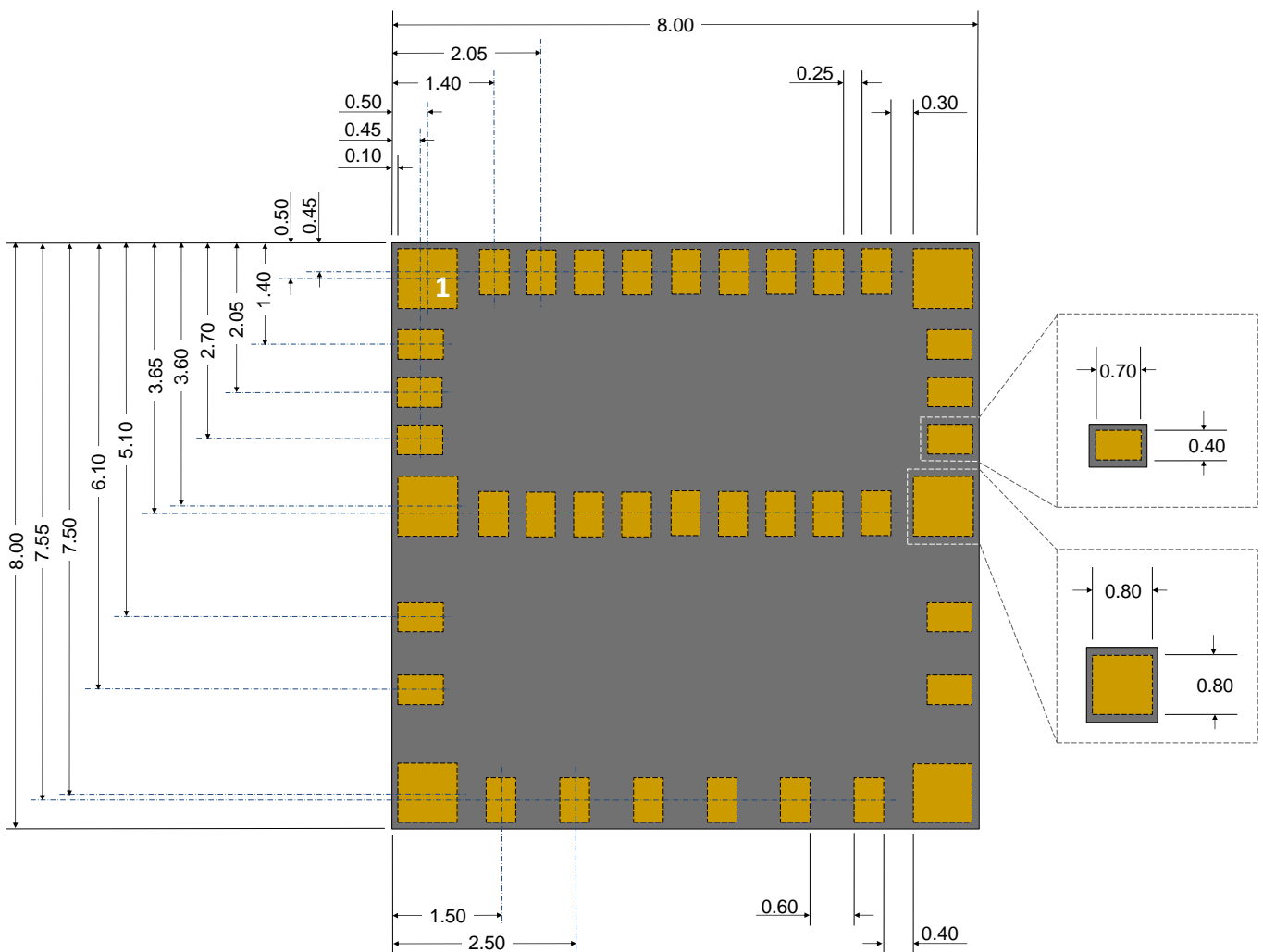

4.2. SMT Assembly Guidelines

For PCB Land Patterns and Solder Mask layout, Insight SiP recommends to use the same dimensions as module pads, ie 0.4 x 0.7 mm for standard pads and 0.8 x 0.8 mm for corner pads.

Please contact Insight SiP for more detailed information.

4.3. Antenna Keep-Out Zone

For optimal antenna performance, it is recommended to respect a metal exclusion zone to the edge of the board: no metal, no traces and no components on any application PCB layer except mechanical LGA pads.

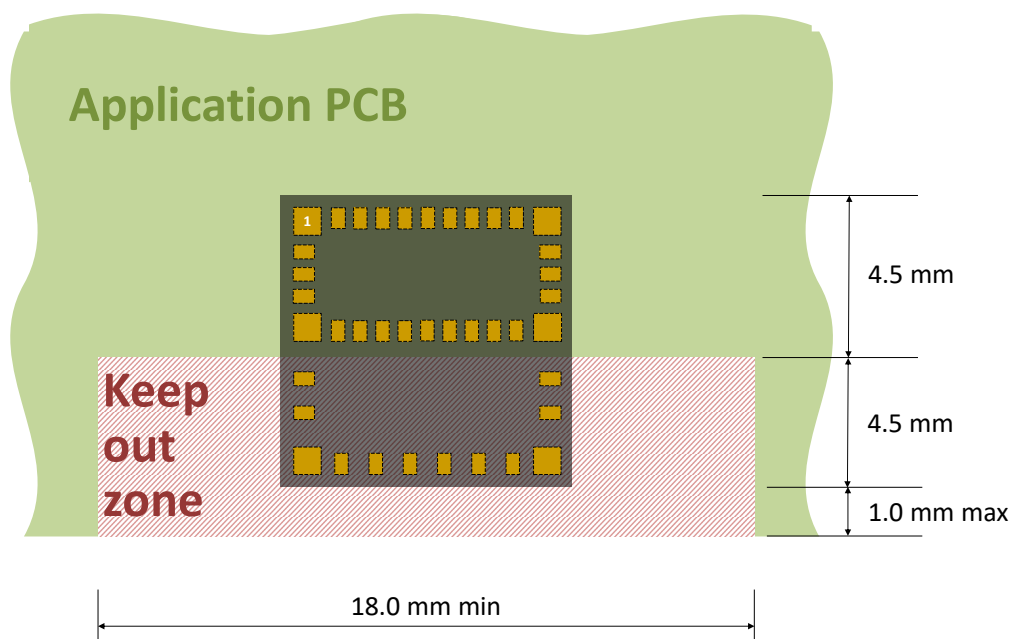

5. Product Development Tools

5.1. Hardware

In order to assist clients in developing their Bluetooth Smart solutions based on the ISP1302, Insight SiP offers a Development Kit containing:

- One Interface Board
- J-Link Lite CortexM-9 JTAG/SWD Emulator
- One Test Board
- One Sensors Board
- A Development Dongle
- 5 ISP1302 module samples
- Cables, power supply and coin battery holder

Using this development kit, product developers can use a working solution as starting point to develop their own products. Time to market is saved by avoiding starting from a blank sheet of paper. In addition, there may be some applications that use the hardware as is.

Please refer to the documentation for more information:

http://www.insightsip.com/fichiers_insightsip/pdf/ble/ISP1302/isp_ble_DS1302_DK.pdf

http://www.insightsip.com/fichiers_insightsip/pdf/ble/ISP1302/isp_ble_AN160301.pdf

5.2. Firmware

ISP1302 supports Bluetooth Low Energy protocol stacks as well as 2.4 GHz protocol stacks, including Gazell, both available as downloads. If ANT protocol is selected as an option, specific ANT protocol stacks are also available as download at www.nordicsemi.com.

- ✚ The S110 SoftDevice is a Bluetooth Low Energy peripheral / broadcaster protocol stack solution. It integrates a Bluetooth Smart controller and host, and provides a full and flexible API for building Bluetooth Smart solutions:
- ✚ The S120 SoftDevice is a Bluetooth low energy central protocol stack solution supporting up to eight simultaneous Central role connections. It integrates a Bluetooth controller and host, and provides a full and flexible API for building Bluetooth Smart solutions.
- ✚ The S130 SoftDevice is a Bluetooth low energy concurrent multi-link protocol stack solution supporting simultaneous Central / Peripheral / Broadcaster / Observer role connections. It integrates a Bluetooth Smart controller and host, and provides a full and flexible API for building Bluetooth Smart solutions.
- ✚ The S210 SoftDevice is an ANT protocol stack solution that provides a full, flexible application programming interface (API) for building ANT solutions for Nordic Semiconductor nRF51 ICs. S210 SoftDevice reduces the need for a secondary application host MCU to ANT solutions.

- ✚ The S310 SoftDevice is an ANT and Bluetooth low energy peripheral controller and hosts a multiprotocol stack that provides a full, flexible application programming interface (API) for building concurrent ANT and Bluetooth Smart solutions for the nRF51422 IC. The S310 SoftDevice reduces the need for a secondary application host MCU as well as the need for an added device to support concurrent multiprotocol.

5.3. Development Tools

The following development tools and software are recommended for using and testing ISP1302 module:

- ✚ Nordic Semiconductor nRFgo Studio:
Downloadable after registering at www.nordicsemi.com.
- ✚ Nordic Semiconductor Master Control Panel:
Downloadable after registering at www.nordicsemi.com.
- ✚ Keil MDK-ARM Lite:
Downloadable from <https://www.keil.com/demo/eval/arm.htm>.
- ✚ Segger J-Link Lite:
Downloadable from <http://www.segger.com/jlink-software.html>.
- ✚ nRF51 Software Development Kit (SDK):
nRF51 SDK can be downloaded after registering at www.nordicsemi.com. It contains example of source codes applications (C language):
 - Precompiled HEX files
 - Source code
 - Keil ARM project files
 - IAR project files
 - GCC project files

5.4. Serialization API

Some applications need the addition of a BLE connectivity while developers want to keep their system architecture based on a specific CPU. Other applications are using BLE SoftDevice that cannot be ported to the ISP1302, for example because they use specific peripherals or need more resources like RAM, flash memory, or CPU speed.

In this case using the ISP1302-BN module preprogrammed with the Nordic BLE Serialization API may be the solution. Serialization makes it possible to place a Bluetooth application on an application module and connect it to a connectivity module that runs the SoftDevice.

Please refer to the following Application Note for more information:

http://www.insightsip.com/fichiers_insightsip/pdf/ble/ISP1302/isp_ble_AN171102.pdf

6.2. Beacon Design

Beacon board is an autonomous low-power device for wireless detection and transmission. The complete device makes use of Insight SiP ISP1302 BLE module together with low power host processor and small primary button cell battery. It has been developed to explore the full range of development possibilities for beacons using Bluetooth Smart technology. They allow indoor positioning, letting your phone know that you are in range of a beacon. As the “beacon” name suggests, they transmit packets of data in regular intervals, and this data can be then picked up by devices like smartphones.

The two buttons can be programmed to enable easy switching between modes and/or functionality. As well an RGB-LED can be configured to indicate different events.

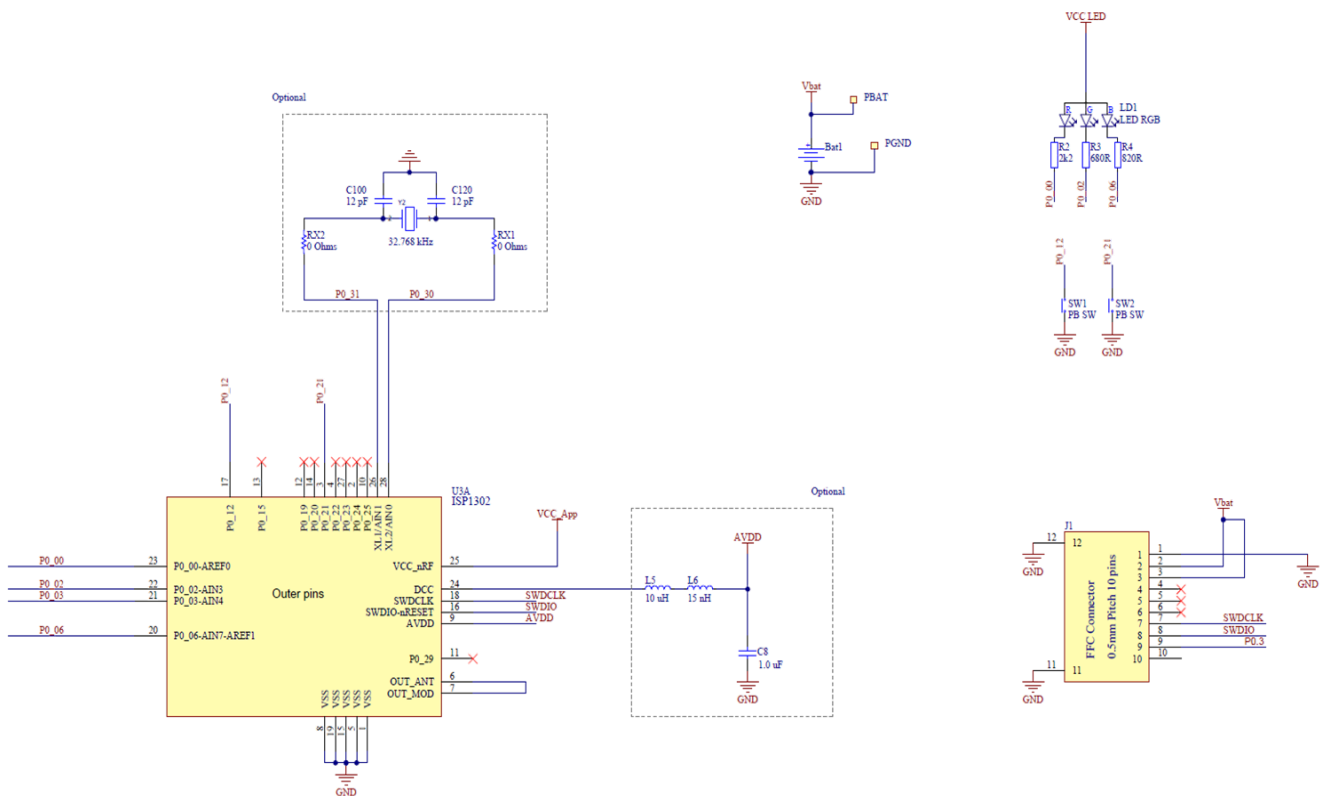

7. Packaging & Ordering information

7.1. Marking

M	/N	:	I	S	P	1	3	0	2
T	T		Y	Y	W	W	R		

ISP1302	Part Number
TT	2 letters Module Type (see section 7.5)
YY	2 digits year number
WW	2 digits week number
R	1 letter Hardware revision

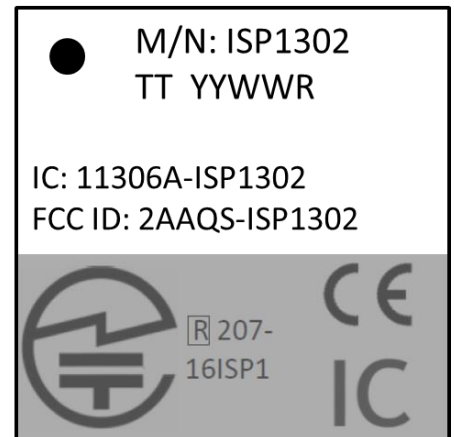

7.2. Prototype Packaging

For engineering samples and prototype quantities up to 99 units, deliveries are provided in thermoformed trays or cut tapes. Please order with “ST” code packaging suffix.

These parts must be baked prior to assembly (see section 8.2).



7.3. Jedec Trays

For pre-production volumes, ISP1302 are available in Jedec trays. They are delivered in sealed pack with desiccant pack and humidity sensors. These Jedec trays are also suitable for further baking. Please see section 8.2 for more information on moisture sensitivity.

Jedec trays are only proposed in standard quantities of 100 units. Please order with “JT” code packaging suffix.

Refer to tray sizes below. Complete information on Jedec trays is available on request.

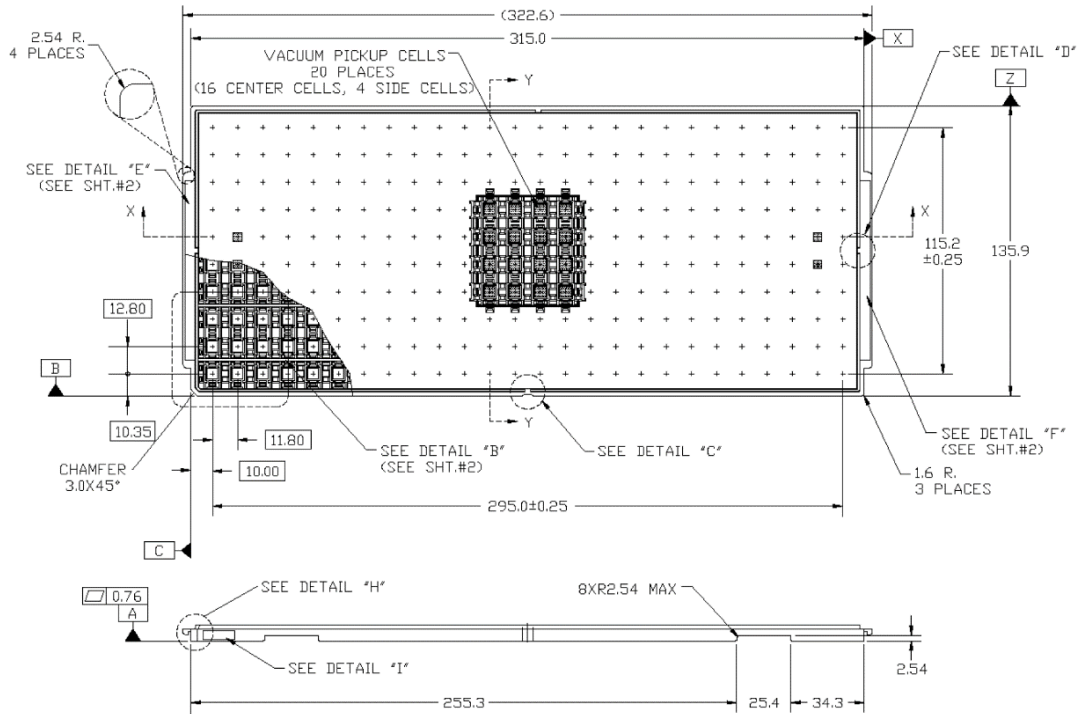

7.4. Tape and Reel

ISP1302 are also available in Tape & Reel. They are delivered in sealed pack with desiccant pack and humidity sensors. Reels are proposed in standard quantities of 2000 units (330mm / 13" reel) only. Please order with "R2" code packaging suffix.

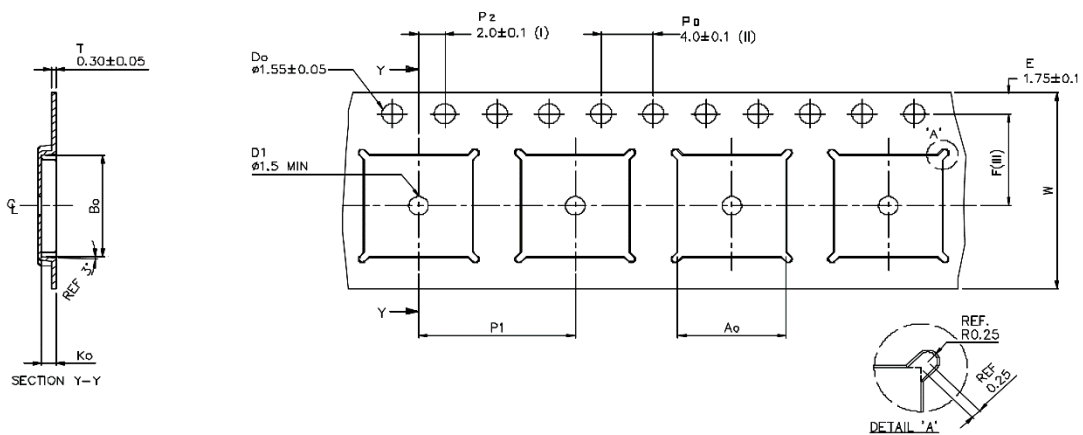

Ao	8.30 +/-0.1
B0	8.30 +/-0.1
Ko	1.10 +/-0.1
F	7.50 +/-0.1
P1	12.00 +/-0.1
W	16.00 +/-0.3

- (I) Measured from centreline of sprocket hole to centreline of pocket.
 - (II) Cumulative tolerance of 10 sprocket holes is ± 0.20 .
 - (III) Measured from centreline of sprocket hole to centreline of pocket.
 - (IV) Other material available.
- ALL DIMENSIONS IN MILLIMETRES UNLESS OTHERWISE STATED.

7.5. Ordering Information

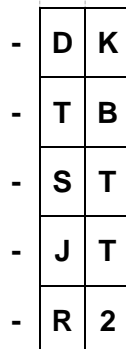
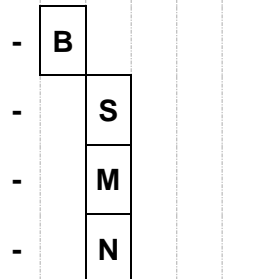
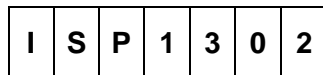
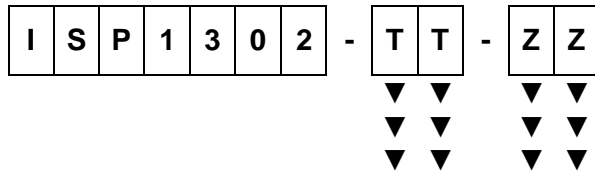

Part Number

BLE protocol type
128 kB Flash / 16 kB RAM memory type
256 kB Flash / 16 kB RAM memory type
256 kB Flash / 16 kB RAM memory type Delivered preprogrammed with Serialization API ⁽²⁾

Development kit ⁽¹⁾
Test board ⁽¹⁾
Unsealed Tray or Cut Tape
Jedec Tray of 100 units
Reel of 2000 units

(1) Please see section 5.1 and refer to the following documentation for more information on development kit and test board:

http://www.insightsip.com/fichiers_insightsip/pdf/ble/ISP1302/isp_ble_DS1302_DK.pdf
http://www.insightsip.com/fichiers_insightsip/pdf/ble/ISP1302/isp_ble_AN160301.pdf

(2) Please refer to the following Application Note for more information on preprogrammed version:

http://www.insightsip.com/fichiers_insightsip/pdf/ble/ISP1302/isp_ble_AN171102.pdf

8. Storage & Soldering information

8.1. Storage and Handling

- ✚ Keep this product away from other high frequency devices which may interfere with operation such as other transmitters and devices generating high frequencies.
- ✚ Do not expose the module to the following conditions:
 - Corrosive gasses such as Cl₂, H₂S, NH₃, SO₂, or NO_x
 - Extreme humidity or salty air
 - Prolonged exposure to direct Sunlight
 - Temperatures beyond those specified for storage
- ✚ Do not apply mechanical stress
- ✚ Do not drop or shock the module
- ✚ Avoid static electricity, ESD and high voltage as these may damage the module

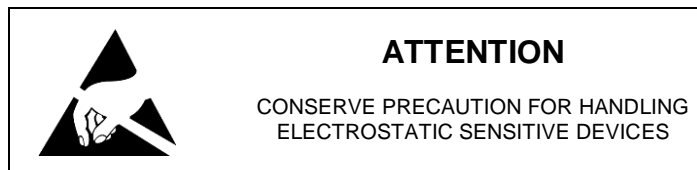

8.2. Moisture Sensitivity

All plastic packages absorb moisture. During typical solder reflow operations when SMDs are mounted onto a PCB, the entire PCB and device population are exposed to a rapid change in ambient temperature. Any absorbed moisture is quickly turned into superheated steam. This sudden change in vapor pressure can cause the package to swell. If the pressure exerted exceeds the flexural strength of the plastic mold compound, then it is possible to crack the package. Even if the package does not crack, interfacial delamination can occur.

Since the device package is sensitive to moisture absorption, it is recommended to bake the product before assembly. The baking process for dry packing is 24 hours at 125°C.

ISP1302 has been tested MSL-5 according to standards. After baking, modules can be exposed to ambient room conditions (approximately 30 °C/60%RH) during 48 hours before assembly on the PCB.



8.3. Soldering information

Recommendation for RoHS reflow process is according to Jedec J-STD-020 and 033 standard profiles.

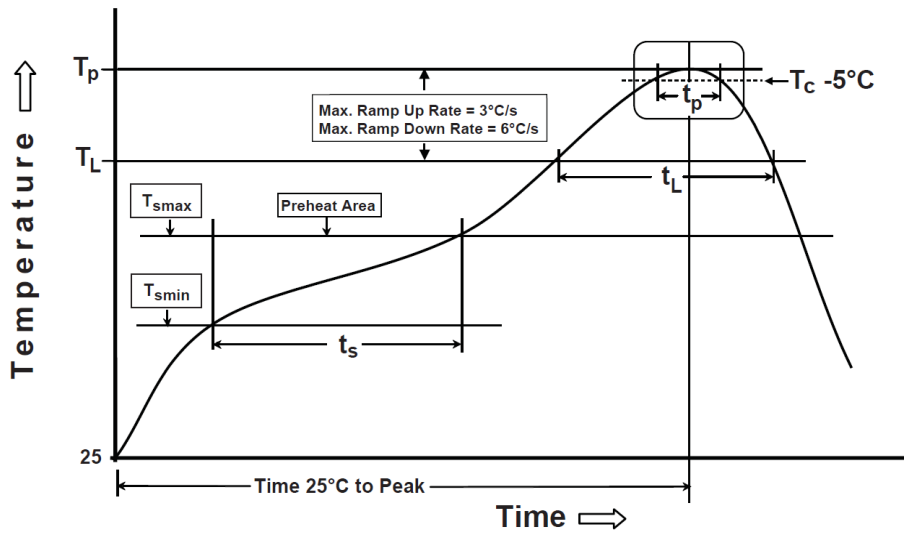

Preheat/Soak	
Temperature Min (T_{smin})	150 °C
Temperature Max (T_{smax})	200 °C
Time (t_s) from (T_{smin} to T_{smax})	60-120 sec
Ramp-up rate (T_L to T_p)	3 °C/sec max
Liquidous temperature (T_L)	217 °C
Time (t_L) maintained above T_L	60-150 sec

Peak package body temperature (T_p)	260°C (+0/-5°C)
Classification Temperature (T_c)	260 °C
Time (t_p) maintained above T_c-5 °C	30 sec
Ramp-down rate (T_p to T_L)	6 °C/sec max
Time 25 °C to peak temperature	8 mn max

9. Quality & User information

9.1. Certifications

- FCC Identifier 2AAQS-ISP1302 – Certificate N° 162185377/AA/00
- CE: Complies with 1999/5/EC, EN300328 V1.9.1 – EC DoC N° TR161001
- IC Certification N° 11306A-ISP1302 – Telefication N° 162172439/AA/00
- TELEC certification N°207 - 16ISP1
- Bluetooth SIG certified N° D032711
- RoHS compliant

9.2. USA – User information

This intends to inform how to specify the FCC ID of our module “ISP1302” on the product. Based on the Public Notice from FCC, the host device should have a label which indicates that it contains our module. The label should use wording such as:

“Contains FCC ID: 2AAQS-ISP1302”

Any similar wording that expresses the same meaning may be used.

The label of the host device should also include the below FCC Statement. When it is not possible, this information should be included in the User Manual of the host device:

*“This device complies with part 15 of the FCC rules. Operation is subject to the following two conditions.
(1) This device may not cause harmful interference
(2) This device must accept any interference received, including interference that may cause undesired operation.
Caution: Any Changes or modifications not expressly approved by the party responsible for compliance could void the user’s authority to operate the equipment.”*

9.3. Canada – User Information

This intends to inform how to specify the IC ID of our module “ISP1302” on the product. According to Canadian standards “RSS-210” and “RSS-Gen”, the host device should have a label which indicates that it contains our module. The label should use wording such as:

“Contains IC: 11306A-ISP1302”

Any similar wording that expresses the same meaning may be used.

The label of the host device should also include the below IC Statement. When it is not possible, this information should be included in the User Manual of the host device:

"This device complies with Industry Canada licence-exempt RSS standard(s). Operation is subject to the following two conditions: (1) this device may not cause interference, and (2) this device must accept any interference, including interference that may cause undesired operation of the device.

Le présent appareil est conforme aux CNR d'Industrie Canada applicables aux appareils radio exempts de licence. L'exploitation est autorisée aux deux conditions suivantes : (1) l'appareil ne doit pas produire de brouillage, et (2) l'utilisateur de l'appareil doit accepter tout brouillage radioélectrique subi, même si le brouillage est susceptible d'en compromettre le fonctionnement."

9.4. Discontinuity

Normally a product will continue to be manufactured as long as all of the following are true:

- The manufacturing method is still available.
- There are no replacement products.
- There is demand for it in the market.

In case of obsolescence, Insight SiP will follow Jedec Standard JSD-48. A Product Discontinuation Notice (PDN) will be sent to all distributors and made available on our website. After this, the procedure goes as follows:

- Last Order Date will be 6 months after the PDN was published.
- Last Shipment Date will be 6 months after Last Order Date, i.e. 12 months after PDN.

9.5. Disclaimer

Insight SiP's products are designed and manufactured for general consumer applications, so testing and use of the product shall be conducted at customer's own risk and responsibility. Please conduct validation and verification and sufficient reliability evaluation of the products in actual condition of mounting and operating environment before commercial shipment of the equipment. Please also pay attention (i) to apply soldering method that don't deteriorate reliability, (ii) to minimize any mechanical vibration, shock, exposure to any static electricity, (iii) not to overstress the product during and after the soldering process.

The products are not designed for use in any application which requires especially high reliability where malfunction of these products can reasonably be expected to result in personal injury or damage to the third party's life, body or property, including and not limited to (i) aircraft equipment, (ii) aerospace equipment, (iii) undersea equipment, (iv) power plant control equipment, (v) medical equipment, (vi) transportation equipment, (vii) traffic signal equipment, (viii) disaster prevention / crime prevention equipment.

The only warranty that Insight SiP provides regarding the products is its conformance to specifications provided in datasheets. Insight SiP hereby disclaims all other warranties regarding the products, express or implied, including without limitation any warranty of fitness for a particular purpose, that they are defect-free, or against infringement of intellectual property rights. Insight SiP customers agree to indemnify and defend Insight SiP against all claims, damages, costs and expenses that may be incurred, including without any limitation, attorney fees and costs, due to the use of products.



Компания «ЭлектроПласт» предлагает заключение долгосрочных отношений при поставках импортных электронных компонентов на взаимовыгодных условиях!

Наши преимущества:

- Оперативные поставки широкого спектра электронных компонентов отечественного и импортного производства напрямую от производителей и с крупнейших мировых складов;
- Поставка более 17-ти миллионов наименований электронных компонентов;
- Поставка сложных, дефицитных, либо снятых с производства позиций;
- Оперативные сроки поставки под заказ (от 5 рабочих дней);
- Экспресс доставка в любую точку России;
- Техническая поддержка проекта, помощь в подборе аналогов, поставка прототипов;
- Система менеджмента качества сертифицирована по Международному стандарту ISO 9001;
- Лицензия ФСБ на осуществление работ с использованием сведений, составляющих государственную тайну;
- Поставка специализированных компонентов (Xilinx, Altera, Analog Devices, Intersil, Interpoint, Microsemi, Aeroflex, Peregrine, Syfer, Eurofarad, Texas Instrument, Miteq, Cobham, E2V, MA-COM, Hittite, Mini-Circuits, General Dynamics и др.);

Помимо этого, одним из направлений компании «ЭлектроПласт» является направление «Источники питания». Мы предлагаем Вам помощь Конструкторского отдела:

- Подбор оптимального решения, техническое обоснование при выборе компонента;
- Подбор аналогов;
- Консультации по применению компонента;
- Поставка образцов и прототипов;
- Техническая поддержка проекта;
- Защита от снятия компонента с производства.



Как с нами связаться

Телефон: 8 (812) 309 58 32 (многоканальный)

Факс: 8 (812) 320-02-42

Электронная почта: org@eplast1.ru

Адрес: 198099, г. Санкт-Петербург, ул. Калинина, дом 2, корпус 4, литера А.