

The S-8355/56/57/58 Series is a CMOS step-up switching regulator controller which mainly consists of a reference voltage source, an oscillation circuit, an error amplifier, a phase compensation circuit, a PWM control circuit (S-8355/57 Series) and a PWM/PFM switching control circuit (S-8356/58 Series).

With an external low-ON-resistance Nch Power MOS, this product is ideal for applications requiring high efficiency and a high output current.

The S-8355/57 Series realizes low ripple, high efficiency, and excellent transient characteristics due to its PWM control circuit whose duty ratio can be varied linearly from 0 to 83% (from 0 to 78% for 250 kHz, 300 kHz, and 600 kHz models), an excellently designed error amplifier and a phase compensation circuits.

S-8356/58 Series features a PWM/PFM switching controller that can switch the operation to a PFM controller with a duty ratio is 15% under a light load to prevent a decline in the efficiency due to the IC operating current.

■ Features

- Low voltage operation : Startup at 0.9 V min. ($I_{OUT} = 1$ mA) guaranteed
- Low current consumption : During operation 25.9 μ A (3.3 V, 100 kHz, typ.)
During shutdown 0.5 μ A (max.)
- Duty ratio : Built-in PWM/PFM switching control circuit (S-8356/58 Series)
15 to 83% (100 kHz models)
15 to 78% (250 kHz, 300 kHz, and 600 kHz models)
- External parts : Coil, diode, capacitor, and transistor
- Output voltage : Selectable in 0.1 V steps between 1.5 and 6.5 V (for V_{DD} / V_{OUT} separate types)
Selectable in 0.1 V steps between 2.0 and 6.5 V (for other than V_{DD} / V_{OUT} separate types)
- Output voltage accuracy : $\pm 2.4\%$
- Oscillation frequency : 100 kHz, 250 kHz, 300 kHz, 600 kHz selectable

- Soft start function : 6 ms (100 kHz, typ.)
- Shutdown function
- Lead-free, Sn 100%, halogen-free^{*1}

*1. Refer to "■ Product Name Structure" for details.

■ Applications

- Power supplies for portable equipment such as digital cameras, electronic notebooks, and PDAs
- Power supplies for audio equipment such as portable CD / MD players
- Constant voltage power supplies for cameras, VCRs, and communications devices
- Power supplies for microcomputers

■ Packages

- SOT-23-3
- SOT-23-5
- SOT-89-3

■ **Block Diagrams**

(1) **S-8357/58 Series B, H and F Types**
 (Without Shutdown Function)



Figure 1

(2) **S-8357/58 Series B, H, F and N Types**
 (With Shutdown Function)



Figure 2

(3) **S-8357/58 Series E, J, G and P Types**
 (V_{DD} / V_{OUT} Separate Type)



Figure 3

(4) **S-8355/56 Series K, L, M and Q Types**
 (With Shutdown Function, V_{DD} / V_{OUT} Separate Type)



Figure 4

■ Product Name Structure

The control system, product types, output voltage, and packages for the S-8355/56/57/58 Series can be selected at the user's request. Please refer to the "3. Product Name" for the definition of the product name, "4. Package" regarding the package drawings and "5. Product Name List" for the full product names.

1. Function List

(1) PWM Control Products

Table 1

Product Name	Switching Frequency kHz	Shutdown Function	V _{DD} / V _{OUT} Separate Type	Package	Application
S-8355KxxMC	100	Yes	Yes	SOT-23-5	Applications requiring variable output voltage and a shutdown function
S-8355LxxMC	250	Yes	Yes	SOT-23-5	Applications requiring variable output voltage, a shutdown function, and a thin coil
S-8355MxxMC	300	Yes	Yes	SOT-23-5	Applications requiring variable output voltage, a shutdown function, and a thin coil
S-8355QxxMC	600	Yes	Yes	SOT-23-5	Applications requiring variable output voltage, a shutdown function, and a thin coil
S-8357BxxMC	100	Yes	–	SOT-23-5	Applications requiring a shutdown function
S-8357BxxMA	100	–	–	SOT-23-3	Applications not requiring a shutdown function
S-8357BxxUA	100	–	–	SOT-89-3	Applications not requiring a shutdown function
S-8357ExxMC	100	–	Yes	SOT-23-5	Applications in which output voltage is adjusted by external resistor
S-8357FxxMC	300	Yes	–	SOT-23-5	Applications requiring a shutdown function and a thin coil
S-8357GxxMC	300	–	Yes	SOT-23-5	Applications requiring variable output voltage and a thin coil
S-8357HxxMC	250	Yes	–	SOT-23-5	Applications requiring a shutdown function and a thin coil
S-8357JxxMC	250	–	Yes	SOT-23-5	Applications requiring variable output voltage with an external resistor and a thin coil
S-8357NxxMC	600	Yes	–	SOT-23-5	Applications requiring a shutdown function and a thin coil
S-8357PxxMC	600	–	Yes	SOT-23-5	Applications requiring variable output voltage with an external resistor and a thin coil

(2) PWM / PFM Switching Control Products

Table 2

Product Name	Switching Frequency kHz	Shutdown Function	V _{DD} / V _{OUT} Separate Type	Package	Application
S-8356KxxMC	100	Yes	Yes	SOT-23-5	Applications requiring variable output voltage and a shutdown function
S-8356LxxMC	250	Yes	Yes	SOT-23-5	Applications requiring variable output voltage, a shutdown function, and a thin coil
S-8356MxxMC	300	Yes	Yes	SOT-23-5	Applications requiring variable output voltage, a shutdown function, and a thin coil
S-8356QxxMC	600	Yes	Yes	SOT-23-5	Applications requiring variable output voltage, a shutdown function, and a thin coil
S-8358BxxMC	100	Yes	–	SOT-23-5	Applications requiring a shutdown function
S-8358BxxMA	100	–	–	SOT-23-3	Applications not requiring a shutdown function
S-8358BxxUA	100	–	–	SOT-89-3	Applications not requiring a shutdown function
S-8358ExxMC	100	–	Yes	SOT-23-5	Applications in which output voltage is adjusted by external resistor
S-8358FxxMC	300	Yes	–	SOT-23-5	Applications requiring a shutdown function and a thin coil
S-8358GxxMC	300	–	Yes	SOT-23-5	Applications requiring variable output voltage and a thin coil
S-8358HxxMC	250	Yes	–	SOT-23-5	Applications requiring a shutdown function and a thin coil
S-8358JxxMC	250	–	Yes	SOT-23-5	Applications requiring variable output voltage with an external resistor and a thin coil
S-8358NxxMC	600	Yes	–	SOT-23-5	Applications requiring a shutdown function and a thin coil
S-8358PxxMC	600	–	Yes	SOT-23-5	Applications requiring variable output voltage with an external resistor and a thin coil

2. Package and Function List by Product Type

Table 3

Series Name	Type	Package Name (Abbreviation)	Shutdown Function Yes / No	V _{DD} / V _{OUT} Separate Type Yes / No
S-8355 Series, S-8356 Series	K, L, M, Q (Shutdown function + V _{DD} / V _{OUT} separate type) K = 100 kHz, L = 250 kHz, M = 300 kHz, Q = 600 kHz	MC	Yes	Yes
S-8357 Series	B, H, F (Normal product) B = 100 kHz, H = 250 kHz, F = 300 kHz	MA / UA	No	No
		MC	Yes	
	N (Normal product) N = 600 kHz	MC	Yes	No
	E, J, G, P (V _{DD} / V _{OUT} separate type) E = 100 kHz, J = 250 kHz, G = 300 kHz, P = 600 kHz	MC	No	Yes
S-8358 Series	B, H, F (Normal product) B = 100 kHz, H = 250 kHz, F = 300 kHz	MA / UA	No	No
		MC	Yes	
	N (Normal product) N = 600 kHz	MC	Yes	No
	E, J, G, P (V _{DD} / V _{OUT} separate type) E = 100 kHz, J = 250 kHz, G = 300 kHz, P = 600 kHz	MC	No	Yes

3. Product Name

(1) SOT-23-3 Packages



*1. Refer to the tape specifications.

*2. Refer to the **Table 4** to **Table 11** in the “**5. Product Name List**”.

(2) SOT-23-5, SOT-89-3 Packages

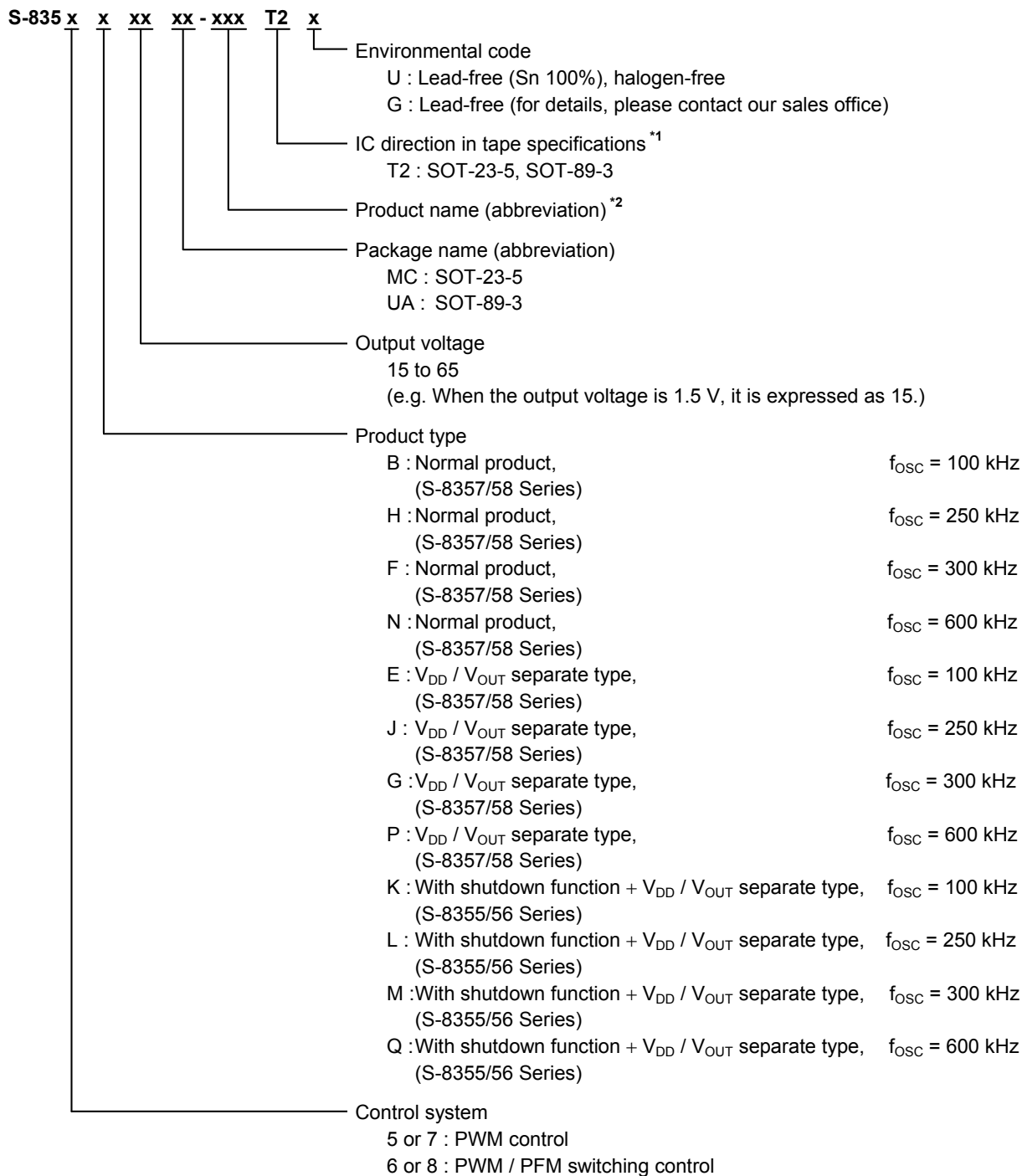

*1. Refer to the tape specifications.

*2. Refer to the Table 4 to Table 11 in the "5. Product Name List".

4. Package

Package Name	Drawing Code		
	Package	Tape	Reel
SOT-23-3	MP003-A-P-SD	MP003-A-C-SD	MP003-A-R-SD
SOT-23-5	MP005-A-P-SD	MP005-A-C-SD	MP005-A-R-SD
SOT-89-3	UP003-A-P-SD	UP003-A-C-SD	UP003-A-R-SD

5. Product Name List

(1) S-8355 Series

Table 4

Output voltage	S-8355KxxMC Series	S-8355LxxMC Series	S-8355MxxMC Series	S-8355QxxMC Series
1.5 V	–	S-8355L15MC-NCAT2x	–	S-8355Q15MC-OWAT2x
1.8 V	S-8355K18MC-NADT2x	–	S-8355M18MC-MCDT2x	S-8355Q18MC-OWDT2x
2.0 V	S-8355K20MC-NAFT2x	S-8355L20MC-NCFT2x	S-8355M20MC-MCFT2x	S-8355Q20MC-OWFT2x
2.4 V	S-8355K24MC-NAJT2x	–	–	S-8355Q24MC-OWJT2x
2.8 V	–	–	–	S-8355Q28MC-OWNT2x
3.0 V	S-8355K30MC-NAPT2x	–	S-8355M30MC-MCPT2x	S-8355Q30MC-OWPT2x
3.1 V	S-8355K31MC-NAQT2x	–	S-8355M31MC-MCQT2x	S-8355Q31MC-OWQT2x
3.2 V	–	–	S-8355M32MC-MCRT2x	–
3.3 V	S-8355K33MC-NAST2x	–	–	S-8355Q33MC-OWST2x
3.4 V	–	–	S-8355M34MC-MCTT2x	S-8355Q34MC-OWTT2x
4.5 V	–	–	–	S-8355Q45MC-OXET2x
5.0 V	S-8355K50MC-NBJT2x	–	S-8355M50MC-MDJT2x	S-8355Q50MC-OXJT2x
5.1 V	–	–	–	S-8355Q51MC-OXKT2x
5.5 V	–	–	S-8355M55MC-MDOT2x	–
6.0 V	–	–	S-8355M60MC-MDTT2x	S-8355Q60MC-OXTT2x
6.5 V	–	–	S-8355M65MC-MDYT2x	–

- Remark 1.** Please contact the ABLIC Inc. marketing department for products with an output voltage other than those specified above.
2. x: G or U
 3. Please select products of environmental code = U for Sn 100%, halogen-free products.

(2) S-8356 Series

Table 5

Output voltage	S-8356KxxMC Series	S-8356LxxMC Series	S-8356MxxMC Series	S-8356QxxMC Series
1.5 V	–	–	S-8356M15MC-MEAT2x	–
1.8 V	S-8356K18MC-NEDT2x	–	S-8356M18MC-MEDT2x	S-8356Q18MC-OYDT2x
2.8 V	–	–	–	S-8356Q28MC-OYNT2x
3.0 V	S-8356K30MC-NEPT2x	S-8356L30MC-NGPT2x	S-8356M30MC-MEPT2x	S-8356Q30MC-OYPT2x
3.1 V	–	–	S-8356M31MC-MEQT2x	S-8356Q31MC-OYQT2x
3.3 V	S-8356K33MC-NEST2x	–	S-8356M33MC-MEST2x	S-8356Q33MC-OYST2x
3.5 V	–	–	S-8356M35MC-MEUT2x	S-8356Q35MC-OYUT2x
3.6 V	S-8356K36MC-NEVT2x	–	S-8356M36MC-MEVT2x	–
4.0 V	S-8356K40MC-NEZT2x	–	–	S-8356Q40MC-OYZT2x
5.0 V	S-8356K50MC-NFJT2x	–	S-8356M50MC-MFJT2x	S-8356Q50MC-OVJT2x
5.3 V	–	–	–	S-8356Q53MC-OVMT2x

- Remark 1.** Please contact the ABLIC Inc. marketing department for products with an output voltage other than those specified above.
2. x: G or U
 3. Please select products of environmental code = U for Sn 100%, halogen-free products.

(3) S-8357 Series

Table 6

Output voltage	S-8357BxxMC Series	S-8357BxxMA Series	S-8357BxxUA Series	S-8357ExxMC Series
1.5 V	–	–	–	S-8357E15MC-NKAT2x
2.0 V	–	–	–	S-8357E20MC-NKFT2x
2.5 V	S-8357B25MC-NIKT2x	–	–	–
2.6 V	S-8357B26MC-NILT2x	–	–	–
2.7 V	S-8357B27MC-NIMT2x	–	–	–
2.8 V	S-8357B28MC-NINT2x	–	–	–
3.0 V	S-8357B30MC-NIPT2x	S-8357B30MA-NIPT2G	–	S-8357E30MC-NKPT2x
3.3 V	S-8357B33MC-NIST2x	S-8357B33MA-NIST2G	S-8357B33UA-NIST2x	–
3.6 V	S-8357B36MC-NIVT2x	–	–	–
3.8 V	–	–	S-8357B38UA-NIXT2x	–
4.0 V	S-8357B40MC-NIZT2x	–	–	–
4.8 V	S-8357B48MC-NJHT2x	–	S-8357B48UA-NJHT2x	–
5.0 V	S-8357B50MC-NJJT2x	S-8357B50MA-NJJT2G	S-8357B50UA-NJJT2x	S-8357E50MC-NLJT2x
5.2 V	S-8357B52MC-NJLT2x	–	–	–
5.4 V	S-8357B54MC-NJNT2x	–	–	–
6.0 V	S-8357B60MC-NJTT2x	–	–	–

Table 7

Output voltage	S-8357FxxMC Series	S-8357GxxMC Series	S-8357HxxMC Series	S-8357JxxMC Series
2.0 V	–	–	–	S-8357J20MC-NOFT2x
2.5 V	–	–	–	S-8357J25MC-NOKT2x
3.0 V	S-8357F30MC-MGPT2x	–	S-8357H30MC-NMPT2G	–
3.1 V	–	–	S-8357H31MC-NMQT2G	–
3.2 V	S-8357F32MC-MGRT2x	S-8357G32MC-MIRT2x	–	–
3.3 V	S-8357F33MC-MGST2x	S-8357G33MC-MIST2x	–	–
3.5 V	–	–	S-8357H35MC-NMUT2x	–
3.6 V	S-8357F36MC-MGVT2x	–	S-8357H36MC-NMVT2x	–
4.2 V	–	–	S-8357H42MC-NNBT2x	–
5.0 V	S-8357F50MC-MHJT2x	S-8357G50MC-MJJT2x	S-8357H50MC-NNJT2x	S-8357J50MC-NPJT2x
5.2 V	S-8357F52MC-MHLT2x	–	S-8357H52MC-NNLT2x	–
6.5 V	S-8357F65MC-MHYT2x	–	–	–

Table 8

Output voltage	S-8357NxxMC Series
3.0 V	S-8357N30MC-O2PT2x
3.3 V	S-8357N33MC-O2ST2x
5.0 V	S-8357N50MC-O3JT2x
5.3 V	S-8357N53MC-O3MT2U

Remark 1. Please contact the ABLIC Inc. marketing department for products with an output voltage other than those specified above.

2. x: G or U

3. Please select products of environmental code = U for Sn 100%, halogen-free products.

(4) S-8358 Series

Table 9

Output voltage	S-8358BxxMC Series	S-8358BxxMA Series	S-8358BxxUA Series	S-8358ExxMC Series
2.0 V	–	–	–	S-8358E20MC-NSFT2x
2.3 V	S-8358B23MC-NQIT2x	–	–	–
2.5 V	S-8358B25MC-NQKT2x	–	–	–
2.6 V	S-8358B26MC-NQLT2x	–	–	–
2.7 V	S-8358B27MC-NQMT2x	–	–	–
2.8 V	S-8358B28MC-NQNT2x	–	–	–
3.0 V	S-8358B30MC-NQPT2x	S-8358B30MA-NQPT2G	–	–
3.1 V	S-8358B31MC-NQQT2x	–	–	–
3.2 V	S-8358B32MC-NQRT2x	–	–	–
3.3 V	S-8358B33MC-NQST2x	–	S-8358B33UA-NQST2x	–
3.5 V	S-8358B35MC-NQUT2x	–	–	–
3.6 V	S-8358B36MC-NQVT2x	–	–	–
3.8 V	S-8358B38MC-NQXT2x	–	–	–
4.0 V	S-8358B40MC-NQZT2x	–	–	–
5.0 V	S-8358B50MC-NRJT2x	S-8358B50MA-NRJT2G	S-8358B50UA-NRJT2x	S-8358E50MC-NTJT2x
5.3 V	S-8358B53MC-NRMT2x	–	–	–
6.0 V	S-8358B60MC-NRTT2x	–	S-8358B60UA-NRTT2x	–

Table 10

Output voltage	S-8358FxxMC Series	S-8358GxxMC Series	S-8358HxxMC Series	S-8358JxxMC Series
2.3 V	–	–	S-8358H23MC-NUIT2x	–
2.6 V	S-8358F26MC-MKLT2x	–	–	–
2.7 V	S-8358F27MC-MKMT2x	–	–	–
3.0 V	S-8358F30MC-MKPT2x	–	S-8358H30MC-NUPT2x	–
3.2 V	–	–	S-8358H32MC-NURT2x	–
3.3 V	S-8358F33MC-MKST2x	–	S-8358H33MC-NUST2x	S-8358J33MC-NWST2x
3.6 V	S-8358F36MC-MKVT2x	–	–	–
4.0 V	–	–	S-8358H40MC-NUZT2x	–
5.0 V	S-8358F50MC-MLJT2x	S-8358G50MC-MNJT2x	S-8358H50MC-NVJT2x	S-8358J50MC-NXJT2x
5.3 V	S-8358F53MC-MLMT2x	–	–	–
5.7 V	S-8358F57MC-MLQT2x	–	–	–
6.0 V	S-8358F60MC-MLTT2x	–	–	–

Table 11

Output voltage	S-8358NxxMC Series	S-8358PxxMC Series
2.0 V	–	S-8358P20MC-O8FT2x
3.0 V	S-8358N30MC-O6PT2x	–
3.3 V	S-8358N33MC-O6ST2x	–
5.0 V	S-8358N50MC-O7JT2x	–
5.2 V	–	S-8358P52MC-O9LT2x
5.3 V	S-8358N53MC-O7MT2x	–

Remark 1. Please contact the ABLIC Inc. marketing department for products with an output voltage other than those specified above.

2. x: G or U

3. Please select products of environmental code = U for Sn 100%, halogen-free products.

■ Pin Configurations

SOT-23-3
 Top view

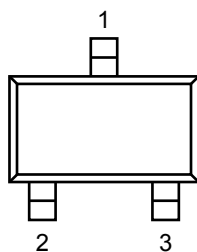

Figure 5

Table 12 S-8357/58 Series B, H and F Types
 (Without shutdown function, V_{DD} / V_{OUT} non-separate type)

Pin No.	Symbol	Pin Description
1	VOUT	Output voltage pin and IC power supply pin
2	VSS	GND pin
3	EXT	External transistor connection pin

SOT-23-5
 Top view

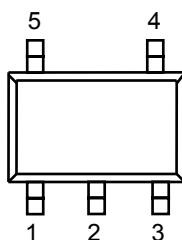

Figure 6

Table 13 S-8355/56 Series K, L, M and Q Types
 (With shutdown function, V_{DD} / V_{OUT} separate type)

Pin No.	Symbol	Pin Description
1	VOUT	Output voltage
2	VDD	IC power supply pin
3	ON/ $\overline{\text{OFF}}$	Shutdown pin "H": Normal operation (Step-up operating) "L": Step-up stopped (Entire circuit stopped)
4	VSS	GND pin
5	EXT	External transistor connection pin

Table 14 S-8357/58 Series B, H, F and N Types
 (With shutdown function, V_{DD} / V_{OUT} non-separate type)

Pin No.	Symbol	Pin Description
1	ON/ $\overline{\text{OFF}}$	Shutdown pin "H": Normal operation (Step-up operating) "L": Step-up stopped (Entire circuit stopped)
2	VOUT	Output voltage pin and IC power supply pin
3	NC*1	No connection
4	VSS	GND pin
5	EXT	External transistor connection pin

*1. The NC pin indicates electrically open.

Table 15 S-8357/58 Series E, J, G and P Types
 (Without shutdown function, V_{DD} / V_{OUT} separate type)

Pin No.	Symbol	Pin Description
1	VOUT	Output voltage pin
2	VDD	IC power supply pin
3	NC*1	No connection
4	VSS	GND pin
5	EXT	External transistor connection pin

*1. The NC pin indicates electrically open.

SOT-89-3
 Top view



Figure 7

Table 16 S-8357/58 Series B, H and F Types
 (Without shutdown function, V_{DD} / V_{OUT} non-separate type)

Pin No.	Symbol	Pin Description
1	VSS	GND pin
2	VOUT	Output voltage pin and IC power supply pin
3	EXT	External transistor connection pin

■ **Absolute Maximum Ratings**

Table 17

(Ta = 25°C unless otherwise specified)

Item		Symbol	Absolute maximum rating	Unit
VOUT pin voltage		V _{OUT}	V _{SS} - 0.3 to V _{SS} + 12	V
ON/OFF pin voltage *1		V _{ON/OFF}	V _{SS} - 0.3 to V _{SS} + 12	V
VDD pin voltage *2		V _{DD}	V _{SS} - 0.3 to V _{SS} + 12	V
EXT pin voltage	B, H, F, N type	V _{EXT}	V _{SS} - 0.3 to V _{OUT} + 0.3	V
	Others		V _{SS} - 0.3 to V _{DD} + 0.3	V
EXT pin current		I _{EXT}	±80	mA
Power dissipation	SOT-23-3	P _D	150 (When not mounted on board)	mW
			430*3	mW
	SOT-23-5		250 (When not mounted on board)	mW
			600*3	mW
SOT-89-3	500 (When not mounted on board)	mW		
	1000*3	mW		
Operating ambient temperature		T _{opr}	-40 to +85	°C
Storage temperature		T _{stg}	-40 to +125	°C

*1. With shutdown function

*2. For V_{DD} / V_{OUT} separate type

*3. When mounted on board

[Mounted board]

(1) Board size : 114.3 mm × 76.2 mm × t1.6 mm

(2) Name : JEDEC STANDARD51-7

Caution The absolute maximum ratings are rated values exceeding which the product could suffer physical damage. These values must therefore not be exceeded under any conditions.

(1) When mounted on board



(2) When not mounted on board



Figure 8 Power Dissipation of The Package

■ Electrical Characteristics

(1) 100 kHz Product (B, E and K Types)

Table 18 (1 / 2)

(Ta = 25°C unless otherwise specified)

Item	Symbol	Condition	Min.	Typ.	Max.	Unit	Measurement circuit	
Output voltage	V _{OUT}	–	V _{OUT(S)} × 0.976	V _{OUT(S)}	V _{OUT(S)} × 1.024	V	2	
Input voltage	V _{IN}	–	–	–	10	V	2	
Operation start voltage	V _{ST1}	I _{OUT} = 1 mA	–	–	0.9	V	2	
Oscillation start voltage	V _{ST2}	No external parts, Voltage applied to V _{OUT}	–	–	0.8	V	1	
Operation holding voltage	V _{HLD}	I _{OUT} = 1 mA, Judged by decreasing V _{IN} voltage gradually	0.7	–	–	V	2	
Current consumption 1	I _{SS1}	V _{OUT} = V _{OUT(S)} × 0.95	S-835xx15 to 19	–	14.0	23.4	μA	1
			S-835xx20 to 29	–	19.7	32.9	μA	1
			S-835xx30 to 39	–	25.9	43.2	μA	1
			S-835xx40 to 49	–	32.6	54.4	μA	1
			S-835xx50 to 59	–	39.8	66.4	μA	1
Current consumption 2	I _{SS2}	V _{OUT} = V _{OUT(S)} + 0.5 V	S-835xx15 to 19	–	5.6	11.1	μA	1
			S-835xx20 to 29	–	5.8	11.5	μA	1
			S-835xx30 to 39	–	5.9	11.8	μA	1
			S-835xx40 to 49	–	6.1	12.1	μA	1
			S-835xx50 to 59	–	6.3	12.5	μA	1
Current consumption during shutdown (With shutdown function)	I _{SSS}	V _{ON/OFF} = 0 V	–	–	0.5	μA	1	
			–	–	0.5	μA	1	
EXT pin output current	I _{EXTH}	V _{EXT} = V _{OUT} – 0.4 V	S-835xx15 to 19	–4.5	–8.9	–	mA	1
			S-835xx20 to 24	–6.2	–12.3	–	mA	1
			S-835xx25 to 29	–7.8	–15.7	–	mA	1
			S-835xx30 to 39	–10.3	–20.7	–	mA	1
			S-835xx40 to 49	–13.3	–26.7	–	mA	1
			S-835xx50 to 59	–16.1	–32.3	–	mA	1
	I _{EXTL}	V _{EXT} = 0.4 V	S-835xx60 to 65	–18.9	–37.7	–	mA	1
			S-835xx15 to 19	9.5	19.0	–	mA	1
			S-835xx20 to 24	12.6	25.2	–	mA	1
			S-835xx25 to 29	15.5	31.0	–	mA	1
			S-835xx30 to 39	19.2	38.5	–	mA	1
			S-835xx40 to 49	23.8	47.6	–	mA	1
			S-835xx50 to 59	27.4	54.8	–	mA	1
S-835xx60 to 65	30.3	60.6	–	mA	1			
Line regulation	ΔV _{OUT1}	V _{IN} = V _{OUT(S)} × 0.4 to × 0.6	–	30	60	mV	2	
Load regulation	ΔV _{OUT2}	I _{OUT} = 10 μA to V _{OUT(S)} / 50 × 1.25	–	30	60	mV	2	
Output voltage temperature coefficient	$\frac{\Delta V_{OUT}}{\Delta T_a \bullet V_{OUT}}$	Ta = –40 to +85°C	–	±50	–	ppm / °C	2	
Oscillation frequency	f _{OSC}	V _{OUT} = V _{OUT(S)} × 0.95	85	100	115	kHz	1	
Maximum duty ratio	MaxDuty	V _{OUT} = V _{OUT(S)} × 0.95	75	83	90	%	1	
PWM / PFM switching duty ratio (For S-8356/58 Series)	PFMDuty	V _{IN} = V _{OUT(S)} – 0.1 V, No-load	10	15	24	%	1	
ON / OFF pin input voltage (With shutdown function)	V _{SH}	Measured oscillation at EXT pin	0.75	–	–	V	1	
	V _{SL1}	Judged oscillation stop at EXT pin	At V _{OUT} ≥ 1.5 V	–	–	0.3	V	1
			At V _{OUT} < 1.5 V	–	–	0.2	V	1

Table 18 (2 / 2)

(Ta = 25°C unless otherwise specified)

Item	Symbol	Condition	Min.	Typ.	Max.	Unit	Measurement circuit
ON / OFF pin input current (For with shutdown function)	I _{SH}	V _{ON/OFF} = V _{OUT(S)} × 0.95	-0.1	-	0.1	μA	1
	I _{SL}	V _{ON/OFF} = 0 V	-0.1	-	0.1	μA	1
Soft start time	t _{SS}	-	3.0	6.0	12.0	ms	2
Efficiency	EFFI	-	-	85	-	%	2

External parts

Coil: CDRH6D28-470 of Sumida Corporation
 Diode: RB461F (Schottky type) of Rohm Co., Ltd.
 Capacitor: F93 (16 V, 47 μF tantalum type) of Nichicon Corporation
 Transistor: CPH3210 of Sanyo Electric Co., Ltd.
 Base resistor (R_b): 1.0 kΩ
 Base capacitor (C_b): 2200 pF (ceramic type)

V_{IN} = V_{OUT(S)} × 0.6 applied, I_{OUT} = V_{OUT(S)} / 50 Ω

With shutdown function : ON / OFF pin is connected to V_{OUT}

For V_{DD} / V_{OUT} separate type : VDD pin is connected to V_{OUT} pin

- Remark**
1. V_{OUT(S)} specified above is the set output voltage value, and V_{OUT} is the typical value of the actual output voltage.
 2. V_{DD} / V_{OUT} separate type
 A step-up operation is performed from V_{DD} = 0.8 V. However, 1.8 V ≤ V_{DD} ≤ 10 V is recommended stabilizing the output voltage and oscillation frequency. (V_{DD} ≥ 1.8 V must be applied for products with a set value of less than 1.9 V.)

(2) 250 kHz Product (H, J and L Types)

Table 19

(Ta = 25°C unless otherwise specified)

Item	Symbol	Condition	Min.	Typ.	Max.	Unit	Measurement circuit	
Output voltage	V_{OUT}	–	$V_{OUT(S)} \times 0.976$	$V_{OUT(S)}$	$V_{OUT(S)} \times 1.024$	V	2	
Input voltage	V_{IN}	–	–	–	10	V	2	
Operation start voltage	V_{ST1}	$I_{OUT} = 1 \text{ mA}$	–	–	0.9	V	2	
Oscillation start voltage	V_{ST2}	No external parts, Voltage applied to V_{OUT}	–	–	0.8	V	1	
Operation holding voltage	V_{HLD}	$I_{OUT} = 1 \text{ mA}$, Judged by decreasing V_{IN} voltage gradually	0.7	–	–	V	2	
Current consumption 1	I_{SS1}	$V_{OUT} = V_{OUT(S)} \times 0.95$	S-835xx15 to 19	–	28.9	48.2	μA	1
			S-835xx20 to 29	–	42.7	71.1	μA	1
			S-835xx30 to 39	–	58.0	96.7	μA	1
			S-835xx40 to 49	–	74.5	124.1	μA	1
			S-835xx50 to 59	–	92.0	153.4	μA	1
			S-835xx60 to 65	–	110.5	184.2	μA	1
Current consumption 2	I_{SS2}	$V_{OUT} = V_{OUT(S)} + 0.5 \text{ V}$	S-835xx15 to 19	–	8.7	17.3	μA	1
			S-835xx20 to 29	–	8.8	17.6	μA	1
			S-835xx30 to 39	–	9.0	18.0	μA	1
			S-835xx40 to 49	–	9.2	18.3	μA	1
			S-835xx50 to 59	–	9.3	18.6	μA	1
			S-835xx60 to 65	–	9.5	19.0	μA	1
Current consumption during shutdown (With shutdown function)	I_{SS3}	$V_{ON/OFF} = 0 \text{ V}$	–	–	0.5	μA	1	
EXT pin output current	I_{EXTH}	$V_{EXT} = V_{OUT} - 0.4 \text{ V}$	S-835xx15 to 19	–4.5	–8.9	–	mA	1
			S-835xx20 to 24	–6.2	–12.3	–	mA	1
			S-835xx25 to 29	–7.8	–15.7	–	mA	1
			S-835xx30 to 39	–10.3	–20.7	–	mA	1
			S-835xx40 to 49	–13.3	–26.7	–	mA	1
			S-835xx50 to 59	–16.1	–32.3	–	mA	1
	I_{EXTL}	$V_{EXT} = 0.4 \text{ V}$	S-835xx15 to 19	9.5	19.0	–	mA	1
			S-835xx20 to 24	12.6	25.2	–	mA	1
			S-835xx25 to 29	15.5	31.0	–	mA	1
			S-835xx30 to 39	19.2	38.5	–	mA	1
			S-835xx40 to 49	23.8	47.6	–	mA	1
			S-835xx50 to 59	27.4	54.8	–	mA	1
			S-835xx60 to 65	30.3	60.6	–	mA	1
			Line regulation	ΔV_{OUT1}	$V_{IN} = V_{OUT(S)} \times 0.4 \text{ to } \times 0.6$	–	30	60
Load regulation	ΔV_{OUT2}	$I_{OUT} = 10 \mu\text{A to } V_{OUT(S)} / 50 \times 1.25$	–	30	60	mV	2	
Output voltage temperature coefficient	$\frac{\Delta V_{OUT}}{\Delta T_a \bullet V_{OUT}}$	$T_a = -40 \text{ to } +85^\circ\text{C}$	–	± 50	–	ppm / °C	2	
Oscillation frequency	f_{OSC}	$V_{OUT} = V_{OUT(S)} \times 0.95$	212.5	250	287.5	kHz	1	
Maximum duty ratio	MaxDuty	$V_{OUT} = V_{OUT(S)} \times 0.95$	70	78	85	%	1	
PWM / PFM switching duty ratio (For S-8356/58 Series)	PFMDuty	$V_{IN} = V_{OUT(S)} - 0.1 \text{ V}$, No-load	10	15	24	%	1	
ON / OFF pin input voltage (With shutdown function)	V_{SH}	Measured oscillation at EXT pin	0.75	–	–	V	1	
	V_{SL1}	Judged oscillation stop at EXT pin	At $V_{OUT} \geq 1.5 \text{ V}$	–	–	0.3	V	1
	V_{SL2}		At $V_{OUT} < 1.5 \text{ V}$	–	–	0.2	V	1
ON / OFF pin input current (With shutdown function)	I_{SH}	$V_{ON/OFF} = V_{OUT(S)} \times 0.95$	–0.1	–	0.1	μA	1	
	I_{SL}	$V_{ON/OFF} = 0 \text{ V}$	–0.1	–	0.1	μA	1	
Soft start time	t_{SS}	–	1.5	3.0	6.0	ms	2	
Efficiency	EFFI	–	–	85	–	%	2	

External parts

Coil:	CDRH6D28-220 of Sumida Corporation
Diode:	RB461F (Schottky type) of Rohm Co., Ltd.
Capacitor:	F93 (16 V, 47 μ F tantalum type) of Nichicon Corporation
Transistor:	CPH3210 of Sanyo Electric Co., Ltd.
Base resistor (R_b):	1.0 k Ω
Base capacitor (C_b):	2200 pF (ceramic type)

$$V_{IN} = V_{OUT(S)} \times 0.6 \text{ applied, } I_{OUT} = V_{OUT(S)} / 50 \Omega$$

With shutdown function : ON/ $\overline{\text{OFF}}$ pin is connected to V_{OUT}

For V_{DD} / V_{OUT} separate type : V_{DD} pin is connected to V_{OUT} pin

- Remark**
1. $V_{OUT(S)}$ specified above is the set output voltage value, and V_{OUT} is the typical value of the actual output voltage.
 2. V_{DD} / V_{OUT} separate type
A step-up operation is performed from $V_{DD} = 0.8$ V. However, $1.8 \text{ V} \leq V_{DD} \leq 10 \text{ V}$ is recommended stabilizing the output voltage and oscillation frequency. ($V_{DD} \geq 1.8$ V must be applied for products with a set value of less than 1.9 V.)

(3) 300 kHz Product (F, G and M Types)

Table 20

(Ta = 25°C unless otherwise specified)

Item	Symbol	Condition	Min.	Typ.	Max.	Unit	Measurement circuit	
Output voltage	V_{OUT}	–	$V_{OUT(S)} \times 0.976$	$V_{OUT(S)}$	$V_{OUT(S)} \times 1.024$	V	2	
Input voltage	V_{IN}	–	–	–	10	V	2	
Operation start voltage	V_{ST1}	$I_{OUT} = 1 \text{ mA}$	–	–	0.9	V	2	
Oscillation start voltage	V_{ST2}	No external parts, Voltage applied to V_{OUT}	–	–	0.8	V	1	
Operation holding voltage	V_{HLD}	$I_{OUT} = 1 \text{ mA}$, Judged by decreasing V_{IN} voltage gradually	0.7	–	–	V	2	
Current consumption 1	I_{SS1}	$V_{OUT} = V_{OUT(S)} \times 0.95$	S-835xx15 to 19	–	33.8	56.4	μA	1
			S-835xx20 to 29	–	50.3	83.9	μA	1
			S-835xx30 to 39	–	68.6	114.4	μA	1
			S-835xx40 to 49	–	88.4	147.4	μA	1
			S-835xx50 to 59	–	109.4	182.4	μA	1
			S-835xx60 to 65	–	131.6	219.3	μA	1
Current consumption 2	I_{SS2}	$V_{OUT} = V_{OUT(S)} + 0.5 \text{ V}$	S-835xx15 to 19	–	9.7	19.4	μA	1
			S-835xx20 to 29	–	9.9	19.7	μA	1
			S-835xx30 to 39	–	10.0	20.0	μA	1
			S-835xx40 to 49	–	10.2	20.4	μA	1
			S-835xx50 to 59	–	10.4	20.7	μA	1
			S-835xx60 to 65	–	10.5	21.0	μA	1
Current consumption during shutdown (With shutdown function)	I_{SSS}	$V_{ON/OFF} = 0 \text{ V}$	–	–	0.5	μA	1	
EXT pin output current	I_{EXTH}	$V_{EXT} = V_{OUT} - 0.4 \text{ V}$	S-835xx15 to 19	–4.5	–8.9	–	mA	1
			S-835xx20 to 24	–6.2	–12.3	–	mA	1
			S-835xx25 to 29	–7.8	–15.7	–	mA	1
			S-835xx30 to 39	–10.3	–20.7	–	mA	1
			S-835xx40 to 49	–13.3	–26.7	–	mA	1
			S-835xx50 to 59	–16.1	–32.3	–	mA	1
	I_{EXTL}	$V_{EXT} = 0.4 \text{ V}$	S-835xx15 to 19	9.5	19.0	–	mA	1
			S-835xx20 to 24	12.6	25.2	–	mA	1
			S-835xx25 to 29	15.5	31.0	–	mA	1
			S-835xx30 to 39	19.2	38.5	–	mA	1
			S-835xx40 to 49	23.8	47.6	–	mA	1
			S-835xx50 to 59	27.4	54.8	–	mA	1
			S-835xx60 to 65	30.3	60.6	–	mA	1
			Line regulation	ΔV_{OUT1}	$V_{IN} = V_{OUT(S)} \times 0.4 \text{ to } \times 0.6$	–	30	60
Load regulation	ΔV_{OUT2}	$I_{OUT} = 10 \mu\text{A to } V_{OUT(S)} / 50 \times 1.25$	–	30	60	mV	2	
Output voltage temperature coefficient	$\frac{\Delta V_{OUT}}{\Delta T_a \bullet V_{OUT}}$	$T_a = -40 \text{ to } +85^\circ\text{C}$	–	± 50	–	ppm / °C	2	
Oscillation frequency	f_{OSC}	$V_{OUT} = V_{OUT(S)} \times 0.95$	255	300	345	kHz	1	
Maximum duty ratio	MaxDuty	$V_{OUT} = V_{OUT(S)} \times 0.95$	70	78	85	%	1	
PWM / PFM switching duty ratio (For S-8356/58 Series)	PFMDuty	$V_{IN} = V_{OUT(S)} - 0.1 \text{ V}$, No-load	10	15	24	%	1	
ON / OFF pin input voltage (With shutdown function)	V_{SH}	Measured oscillation at EXT pin	0.75	–	–	V	1	
	V_{SL1}	Judged oscillation stop at EXT pin	At $V_{OUT} \geq 1.5 \text{ V}$	–	–	0.3	V	1
	V_{SL2}		At $V_{OUT} < 1.5 \text{ V}$	–	–	0.2	V	1
ON / OFF pin input current (With shutdown function)	I_{SH}	$V_{ON/OFF} = V_{OUT(S)} \times 0.95$	–0.1	–	0.1	μA	1	
	I_{SL}	$V_{ON/OFF} = 0 \text{ V}$	–0.1	–	0.1	μA	1	
Soft start time	t_{SS}	–	1.5	3.0	6.0	ms	2	
Efficiency	EFFI	–	–	85	–	%	2	

External parts

Coil:	CDRH6D28-220 of Sumida Corporation
Diode:	RB461F (Schottky type) of Rohm Co., Ltd.
Capacitor:	F93 (16 V, 47 μ F tantalum type) of Nichicon Corporation
Transistor:	CPH3210 of Sanyo Electric Co., Ltd.
Base resistor (R_b):	1.0 k Ω
Base capacitor (C_b):	2200 pF (ceramic type)

$$V_{IN} = V_{OUT(S)} \times 0.6 \text{ applied, } I_{OUT} = V_{OUT(S)} / 50 \Omega$$

With shutdown function : ON/ $\overline{\text{OFF}}$ pin is connected to V_{OUT}

For V_{DD} / V_{OUT} separate type : V_{DD} pin is connected to V_{OUT} pin

- Remark**
1. $V_{OUT(S)}$ specified above is the set output voltage value, and V_{OUT} is the typical value of the actual output voltage.
 2. V_{DD} / V_{OUT} separate type
A step-up operation is performed from $V_{DD} = 0.8$ V. However, $1.8 \text{ V} \leq V_{DD} \leq 10 \text{ V}$ is recommended stabilizing the output voltage and oscillation frequency. ($V_{DD} \geq 1.8$ V must be applied for products with a set value of less than 1.9 V.)

(4) 600 kHz Product (N Type)

Table 21

(Ta = 25°C unless otherwise specified)

Item	Symbol	Condition	Min.	Typ.	Max.	Unit	Measurement circuit	
Output voltage	V_{OUT}	–	$V_{OUT(S)} \times 0.976$	$V_{OUT(S)}$	$V_{OUT(S)} \times 1.024$	V	2	
Input voltage	V_{IN}	–	–	–	10	V	2	
Operation start voltage	V_{ST1}	$I_{OUT} = 1 \text{ mA}$	–	–	0.9	V	2	
Oscillation start voltage	V_{ST2}	No external parts, Voltage applied to V_{OUT}	–	–	0.8	V	1	
Operation holding voltage	V_{HLD}	$I_{OUT} = 1 \text{ mA}$, Judged by decreasing V_{IN} voltage gradually	0.7	–	–	V	2	
Current consumption 1	I_{SS1}	$V_{OUT} = V_{OUT(S)} \times 0.95$	S-835xx15 to 19	–	63.6	105.9	μA	1
			S-835xx20 to 29	–	96.4	160.6	μA	1
			S-835xx30 to 39	–	132.8	221.3	μA	1
			S-835xx40 to 49	–	172.2	286.9	μA	1
			S-835xx50 to 59	–	214.0	356.7	μA	1
Current consumption 2	I_{SS2}	$V_{OUT} = V_{OUT(S)} + 0.5 \text{ V}$	S-835xx15 to 19	–	15.9	31.8	μA	1
			S-835xx20 to 29	–	16.1	32.1	μA	1
			S-835xx30 to 39	–	16.2	32.4	μA	1
			S-835xx40 to 49	–	16.4	32.8	μA	1
			S-835xx50 to 59	–	16.6	33.1	μA	1
Current consumption during shutdown	I_{SSS}	$V_{ON/OFF} = 0 \text{ V}$	–	–	0.5	μA	1	
			–	–	0.5	μA	1	
EXT pin output current	I_{EXTH}	$V_{EXT} = V_{OUT} - 0.4 \text{ V}$	S-835xx15 to 19	–4.5	–8.9	–	mA	1
			S-835xx20 to 24	–6.2	–12.3	–	mA	1
			S-835xx25 to 29	–7.8	–15.7	–	mA	1
			S-835xx30 to 39	–10.3	–20.7	–	mA	1
			S-835xx40 to 49	–13.3	–26.7	–	mA	1
			S-835xx50 to 59	–16.1	–32.3	–	mA	1
			S-835xx60 to 65	–18.9	–37.7	–	mA	1
	I_{EXTL}	$V_{EXT} = 0.4 \text{ V}$	S-835xx15 to 19	9.5	19.0	–	mA	1
			S-835xx20 to 24	12.6	25.2	–	mA	1
			S-835xx25 to 29	15.5	31.0	–	mA	1
			S-835xx30 to 39	19.2	38.5	–	mA	1
			S-835xx40 to 49	23.8	47.6	–	mA	1
			S-835xx50 to 59	27.4	54.8	–	mA	1
			S-835xx60 to 65	30.3	60.6	–	mA	1
Line regulation	ΔV_{OUT1}	$V_{IN} = V_{OUT(S)} \times 0.4 \text{ to } \times 0.6$	–	30	60	mV	2	
Load regulation	ΔV_{OUT2}	$I_{OUT} = 10 \mu\text{A to } V_{OUT(S)} / 50 \times 1.25$	–	30	60	mV	2	
Output voltage temperature coefficient	$\frac{\Delta V_{OUT}}{\Delta T_a \bullet V_{OUT}}$	$T_a = -40 \text{ to } +85^\circ\text{C}$	–	± 50	–	$\text{ppm} / ^\circ\text{C}$	2	
Oscillation frequency	f_{OSC}	$V_{OUT} = V_{OUT(S)} \times 0.95$	510	600	690	kHz	1	
Maximum duty ratio	MaxDuty	$V_{OUT} = V_{OUT(S)} \times 0.95$	65	78	85	%	1	
PWM / PFM switching duty ratio (For S-8356/58 Series)	PFMDuty	$V_{IN} = V_{OUT(S)} - 0.1 \text{ V}$, No-load	10	15	24	%	1	
ON / OFF pin input voltage	V_{SH}	Measured oscillation at EXT pin	0.75	–	–	V	1	
	V_{SL1}	Judged oscillation stop at EXT pin	–	–	0.3	V	1	
	V_{SL2}	At $V_{OUT} \geq 1.5 \text{ V}$ At $V_{OUT} < 1.5 \text{ V}$	–	–	0.2	V	1	
ON / OFF pin input current	I_{SH}	$V_{ON/OFF} = V_{OUT(S)} \times 0.95$	–0.1	–	0.1	μA	1	
	I_{SL}	$V_{ON/OFF} = 0 \text{ V}$	–0.1	–	0.1	μA	1	
Soft start time	t_{SS}	–	1.5	3.0	6.0	ms	2	
Efficiency	EFFI	–	–	85	–	%	2	

External parts

Coil:	CDRH6D28-100 of Sumida Corporation
Diode:	RB461F (Schottky type) of Rohm Co., Ltd.
Capacitor:	F93 (16 V, 47 μ F tantalum type) of Nichicon Corporation
Transistor:	CPH3210 of Sanyo Electric Co., Ltd.
Base resistor (R_b):	1.0 k Ω
Base capacitor (C_b):	2200 pF (ceramic type)

$$V_{IN} = V_{OUT(S)} \times 0.6 \text{ applied, } I_{OUT} = V_{OUT(S)} / 50 \Omega, \text{ ON/OFF} = V_{OUT}$$

Remark $V_{OUT(S)}$ specified above is the set output voltage value, and V_{OUT} is the typical value of the actual output voltage.

(5) 600 kHz Product (P and Q types)

Table 22

(Ta = 25°C unless otherwise specified)

Item	Symbol	Condition	Min.	Typ.	Max.	Unit	Measurement circuit	
Output voltage	V _{OUT}	–	V _{OUT(S)} × 0.976	V _{OUT(S)}	V _{OUT(S)} × 1.024	V	4	
Input voltage	V _{IN}	–	–	–	10	V	4	
Operation start voltage	V _{ST1}	I _{OUT} = 1 mA	–	–	0.9	V	4	
Oscillation start voltage	V _{ST2}	No external parts, Voltage applied to V _{DD}	–	–	0.8	V	3	
Operation holding voltage	V _{HLD}	I _{OUT} = 1 mA, Judged by decreasing V _{IN} voltage gradually	0.7	–	–	V	4	
Current consumption 1	I _{SS1}	V _{DD} = 3.3 V	–	132.8	221.3	μA	3	
Current consumption 2	I _{SS2}	V _{DD} = 3.3 V	–	16.2	32.4	μA	3	
Current consumption during shutdown (With shutdown function)	I _{SS3}	V _{ON/OFF} = 0 V	–	–	0.5	μA	3	
EXT pin output current	I _{EXTH}	V _{DD} = 3.3 V	–10.3	–20.7	–	mA	3	
	I _{EXTL}	V _{DD} = 3.3 V	19.2	38.5	–	mA	3	
Line regulation	ΔV _{OUT1}	V _{IN} = V _{OUT(S)} × 0.4 to × 0.6	–	30	60	mV	4	
Load regulation	ΔV _{OUT2}	I _{OUT} = 10 μA to V _{OUT(S)} / 50 × 1.25	–	30	60	mV	4	
Output voltage temperature coefficient	$\frac{\Delta V_{OUT}}{\Delta T_a \bullet V_{OUT}}$	Ta = –40 to +85°C	–	±50	–	ppm / °C	4	
Oscillation frequency	f _{OSC}	V _{DD} = 3.3 V	510	600	690	kHz	3	
Maximum duty ratio	MaxDuty	V _{DD} = 3.3 V	65	78	85	%	3	
PWM / PFM switching duty ratio (For S-8356/58 Series)	PFMDuty	V _{IN} = V _{OUT(S)} – 0.1 V, No-load	10	15	24	%	3	
ON / OFF pin input voltage (With shutdown function)	V _{SH}	Measured oscillation at EXT pin	0.75	–	–	V	3	
	V _{SL1}	Judged oscillation stop at EXT pin	At V _{OUT} ≥ 1.5 V	–	–	0.3	V	3
	V _{SL2}		At V _{OUT} < 1.5 V	–	–	0.2	V	3
ON / OFF pin input current (With shutdown function)	I _{SH}	V _{ON/OFF} = V _{OUT(S)} × 0.95	–0.1	–	0.1	μA	3	
	I _{SL}	V _{ON/OFF} = 0 V	–0.1	–	0.1	μA	3	
Soft start time	t _{SS}	–	1.5	3.0	6.0	ms	4	
Efficiency	EFFI	–	–	85	–	%	4	

External parts

Coil: CDRH6D28-100 of Sumida Corporation
 Diode: RB461F (Schottky type) of Rohm Co., Ltd.
 Capacitor: F93 (16 V, 47 μF tantalum type) of Nichicon Corporation
 Transistor: CPH3210 of Sanyo Electric Co., Ltd.
 Base resistor (R_b): 1.0 kΩ
 Base capacitor (C_b): 2200 pF (ceramic type)

V_{IN} = V_{OUT(S)} × 0.6 applied, I_{OUT} = V_{OUT(S)} / 50 Ω, ON / OFF = V_{OUT}

- Remark**
1. V_{OUT(S)} specified above is the set output voltage value, and V_{OUT} is the typical value of the actual output voltage.
 2. V_{DD} / V_{OUT} separate type
 A step-up operation is performed from V_{DD} = 0.8 V. However, 1.8 V ≤ V_{DD} ≤ 10 V is recommended stabilizing the output voltage and oscillation frequency. (V_{DD} ≥ 1.8 V must be applied for products with a set value of less than 1.9 V.)

■ **Measurement Circuits**



Figure 9



Figure 10



Figure 11



Figure 12

*1. With shutdown function

*2. For V_{DD} / V_{OUT} separate type

■ Operation

1. Switching Control Types

1.1 PWM Control (S-8355/57 Series)

The S-8355/57 Series is a DC-DC converter using a pulse width modulation method (PWM) and features a low current consumption.

In conventional PFM DC-DC converters, pulses are skipped when the output load current is low, causing a fluctuation in the ripple frequency of the output voltage, resulting in an increase in the ripple voltage. The switching frequency does not change, although the pulse width changes from 0 to 83% (78% for F, G, H, J, L, M, N, P and Q types) corresponding to each load current. The ripple voltage generated from switching can thus be removed easily through a filter because the switching frequency is constant.

1.2 PWM/PFM Switching Control (S-8356/58 Series)

S-8356/58 Series is a DC-DC converter that automatically switches between a pulse width modulation method (PWM) and a pulse frequency modulation method (PFM), depending on the load current, and features low current consumption.

The S-8356/58 Series operates under PWM control with the pulse width duty changing from 15 to 83% (78% for F, G, H, J, L, M, N, P and Q types) in a high output load current area.

The S-8356/58 Series operates under PFM control with the pulse width duty fixed at 15%, and pulses are skipped according to the load current. The oscillation circuit thus oscillates intermittently so that the resultant lower self current consumption prevents a reduction in the efficiency at a low load current. The switching point from PWM control to PFM control depends on the external devices (coil, diode, etc.), input voltage and output voltage. This series are an especially highly efficient DC-DC converter at an output current around 100 μ A.

2. Soft Start Function

For this IC, the built-in soft start circuit controls the rush current and overshoot of the output voltage when powering on or when the ON/ $\overline{\text{OFF}}$ pin is switched to the "H" level.

3. ON/OFF Pin (Shutdown Pin) (SOT-23-5 Package Products of S-8355/56/57/58 Series B, H, F, K, L, M, N and Q Types)

ON/OFF pin stops or starts step-up operation.

Setting the ON/OFF pin to the “L” level stops operation of all the internal circuits and reduces the current consumption significantly.

DO NOT use the ON/OFF pin in a floating state because it has the structure shown in **Figure 13** and is not pulled up or pulled down internally. DO NOT apply a voltage of between 0.3 V and 0.75 V to the ON/OFF pin because applying such a voltage increases the current consumption. If the ON/OFF pin is not used, connect it to the VOUT pin.

The ON/OFF pin does not have hysteresis.

Table 23

ON/OFF pin	CR oscillation circuit	Output voltage
“H”	Operation	Fixed
“L”	Stop	$\cong V_{IN}^{*1}$

*1. Voltage obtained by subtracting the voltage drop due to the DC resistance of the inductor and the diode forward voltage from V_{IN} .



*1. VDD for K, L, M and Q types.

Figure 13 ON/OFF Pin Structure

4. Operation

The following are the basic equations [(1) through (7)] of the step-up switching regulator. (Refer to **Figure 14**.)



Figure 14 Step-Up Switching Regulator Circuit for Basic Equation

Voltage at CONT pin at the moment M1 is turned ON (V_A) *1 :

$$V_A = V_S \text{ *2} \dots\dots\dots (1)$$

- *1. Current flowing through L (I_L) is zero.
- *2. Non-saturated voltage of M1.

The change in I_L over time :

$$\frac{dI_L}{dt} = \frac{V_L}{L} = \frac{V_{IN} - V_S}{L} \dots\dots\dots (2)$$

Integration of equation (2) (I_L) :

$$I_L = \left(\frac{V_{IN} - V_S}{L} \right) \cdot t \dots\dots\dots (3)$$

I_L flows while M1 is ON (t_{ON}). The time of t_{ON} is determined by the oscillation frequency of OSC.

The peak current (I_{PK}) after t_{ON} :

$$I_{PK} = \left(\frac{V_{IN} - V_S}{L} \right) \cdot t_{ON} \dots\dots\dots (4)$$

The energy stored in L is represented by $1/2 \cdot L \cdot (I_{PK})^2$.

When M1 is turned OFF (t_{OFF}), the energy stored in L is emitted through a diode to the output capacitor.

Then, the reverse voltage (V_L) is generated :

$$V_L = (V_{OUT} + V_D \text{ *1}) - V_{IN} \dots\dots\dots (5)$$

- *1. Diode forward voltage

The voltage at CONT pin rises only by $V_{OUT} + V_D$.

The change in the current (I_L) flowing through the diode into V_{OUT} during t_{OFF} :

$$\frac{dI_L}{dt} = \frac{V_L}{L} = \frac{V_{OUT} + V_D - V_{IN}}{L} \dots\dots\dots (6)$$

Integration of the equation (6) is as follows :

$$I_L = I_{PK} - \left(\frac{V_{OUT} + V_D - V_{IN}}{L} \right) \cdot t \dots\dots\dots (7)$$

During t_{ON} , the energy is stored in L and is not transmitted to V_{OUT} . When receiving the output current (I_{OUT}) from V_{OUT} , the energy of the capacitor (C_L) is consumed. As a result, the pin voltage of C_L is reduced, and goes to the lowest level after M1 is turned ON (t_{ON}). When M1 is turned OFF, the energy stored in L is transmitted through the diode to C_L , and the voltage of C_L rises rapidly. V_{OUT} is a time function, and therefore indicates the maximum value (ripple voltage (V_{P-P})) when the current flowing through into V_{OUT} and load current (I_{OUT}) match.

Next, the ripple voltage is determined as follows.

I_{OUT} vs. t_1 (time) from when M1 is turned OFF (after t_{ON}) to when V_{OUT} reaches the maximum level :

$$I_{OUT} = I_{PK} - \left(\frac{V_{OUT} + V_D - V_{IN}}{L} \right) \cdot t_1 \dots\dots\dots (8)$$

$$\therefore t_1 = (I_{PK} - I_{OUT}) \cdot \left(\frac{L}{V_{OUT} + V_D - V_{IN}} \right) \dots\dots\dots (9)$$

When M1 is turned OFF (t_{OFF}), $I_L = 0$ (when the energy of the inductor is completely transmitted). Based on equation (7) :

$$\left(\frac{L}{V_{OUT} + V_D - V_{IN}} \right) = \frac{t_{OFF}}{I_{PK}} \dots\dots\dots (10)$$

When substituting equation (10) for equation (9) :

$$t_1 = t_{OFF} - \left(\frac{I_{OUT}}{I_{PK}} \right) \cdot t_{OFF} \dots\dots\dots (11)$$

Electric charge ΔQ_1 which is charged in C_L during t_1 :

$$\Delta Q_1 = \int_0^{t_1} I_L dt = I_{PK} \cdot \int_0^{t_1} dt - \frac{V_{OUT} + V_D - V_{IN}}{L} \cdot \int_0^{t_1} t dt = I_{PK} \cdot t_1 - \frac{V_{OUT} + V_D - V_{IN}}{L} \cdot \frac{1}{2} t_1^2 \dots\dots\dots (12)$$

When substituting equation (12) for equation (9) :

$$\Delta Q_1 = I_{PK} - \frac{1}{2} (I_{PK} - I_{OUT}) \cdot t_1 = \frac{I_{PK} + I_{OUT}}{2} \cdot t_1 \dots\dots\dots (13)$$

A rise in voltage (V_{P-P}) due to ΔQ_1 :

$$V_{P-P} = \frac{\Delta Q_1}{C_L} = \frac{1}{C_L} \cdot \left(\frac{I_{PK} + I_{OUT}}{2} \right) \cdot t_1 \dots\dots\dots (14)$$

When taking into consideration I_{OUT} to be consumed during t_1 and the Equivalent Series Resistance (R_{ESR}) of C_L :

$$V_{P-P} = \frac{\Delta Q_1}{C_L} = \frac{1}{C_L} \cdot \left(\frac{I_{PK} + I_{OUT}}{2} \right) \cdot t_1 + \left(\frac{I_{PK} + I_{OUT}}{2} \right) \cdot R_{ESR} - \frac{I_{OUT} \cdot t_1}{C_L} \dots\dots\dots (15)$$

When substituting equation (11) for equation (15) :

$$V_{P-P} = \frac{(I_{PK} - I_{OUT})^2}{2I_{PK}} \cdot \frac{t_{OFF}}{C_L} + \left(\frac{I_{PK} + I_{OUT}}{2} \right) \cdot R_{ESR} \dots\dots\dots (16)$$

Therefore to reduce the ripple voltage, it is important that the capacitor connected to the output pin has a large capacity and a small R_{ESR} .

■ External Parts Selection

The relationship between the major characteristics of the step-up circuit and the characteristics parameters of the external parts are shown in **Figure 15**.

For larger output current ?	For higher efficiency ?		For smaller ripple voltage ?
	Operation efficiency	Stand-by efficiency	
Smaller inductance	Larger inductance		
Smaller direct current resistance of inductor			
Larger output capacitance			Larger output capacitance
With MOS FET, smaller ON resistance		With MOS FET, smaller input capacitance	
With bipolar transistor, smaller external resistance R_b		With bipolar transistor, larger external resistance R_b	

Figure 15 Relationship between Major Characteristics of Step-up Circuit and External Parts

1. Inductor

The inductance value (L value) has a strong influence on the maximum output current (I_{OUT}) and efficiency (η). **Figure 16** shows the relationship between the I_{OUT} and η dependency on L of S-8355/56/57/58 series.



Figure 16 L Value vs. I_{OUT} Characteristics, L Value vs. η Characteristics

The peak current (I_{PK}) increases by decreasing L value and the stability of the circuit improves and I_{OUT} increases. If L value is decreased, the efficiency falls causing a decline in the current drive capacity for the switching transistor, and I_{OUT} decreases.

The loss of I_{PK} by the switching transistor decreases by increasing L value and the efficiency becomes maximum at a certain L value. Further increasing L value decreases the efficiency due to the loss of the direct current resistance of the coil. I_{OUT} also decreases.

A higher oscillation frequency allows selection of a lower L value, making the coil smaller.

The recommended inductances are a 22 to 100 μH for B, E, and K types, a 4.7 to 47 μH for F, G, H, J, L, and M types, 3.0 to 22 μH for N, P and Q types.

Be careful of the allowable inductor current when choosing an inductor. Exceeding the allowable current of the inductor causes magnetic saturation, much lower efficiency and destruction of the IC chip due to a large current.

Choose an inductor so that I_{PK} does not exceed the allowable current. I_{PK} in discontinuous mode is calculated by the following equation:

$$I_{PK} = \sqrt{\frac{2 I_{OUT} (V_{OUT} + V_D - V_{IN})}{f_{OSC} \cdot L}} \quad (\text{A}) \quad \dots\dots\dots (17)$$

f_{osc} = oscillation frequency, $V_D \cong 0.4\text{ V}$.

2. Diode

Use an external diode that meets the following requirements :

- Low forward voltage : $V_F < 0.3\text{ V}$
- High switching speed : 500 ns max.
- Reverse voltage : $V_{OUT} + V_F$ or more
- Current rate : I_{PK} or more

3. Capacitor (C_{IN} , C_L)

A capacitor on the input side (C_{IN}) improves the efficiency by reducing the power impedance and stabilizing the input current. Select a C_{IN} value according to the impedance of the power supply used.

A capacitor on the output side (C_L) is used for smoothing the output voltage. For step-up types, the output voltage flows intermittently to the load current, so step-up types need a larger capacitance than step-down types. Therefore, select an appropriate capacitor in accordance with the ripple voltage, which increases in case of a higher output voltage or a higher load current. The capacitor value should be 10 μ F or more.

Select an appropriate capacitor the equivalent series resistance (R_{ESR}) for stable output voltage. The stable voltage range in this IC depends on the R_{ESR} . Although the inductance value (L value) is also a factor, an R_{ESR} of 30 to 500 m Ω maximizes the characteristics. However, the best R_{ESR} value may depend on the L value, the capacitance, the wiring, and the applications (output load). Therefore, fully evaluate the R_{ESR} under the actual operating conditions to determine the best value.

Refer to the “3. Example of Ceramic Capacitor Application” (Figure 26) in the “Application Circuit” for the circuit example using a ceramic capacitor and the external resistance of the capacitor (R_{ESR}).

4. External Transistor

An enhancement (N-channel) MOS FET type or A bipolar (NPN) type can be used as the external transistor.

4.1 Enhancement (N-channel) MOS FET Type

Figure 17 is a circuit example using a MOS FET transistor (N-channel).

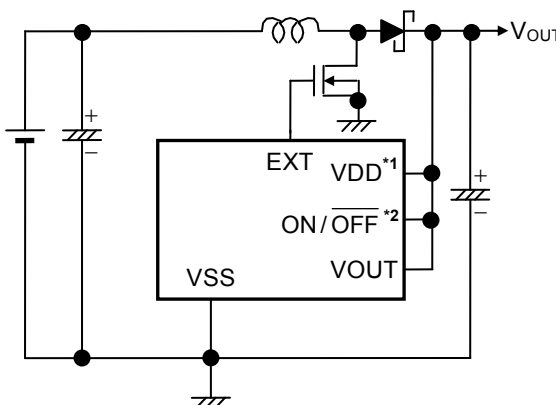

*1. For V_{DD} / V_{OUT} separate type.

*2. With shutdown function.

Figure 17 Circuit Example Using MOS FET (N-channel) Type

An N-channel power MOS FET should be used for the MOS FET. Because the gate voltage and current of the external power MOS FET are supplied from the stepped-up output voltage (V_{OUT}), the MOS FET is driven more effectively.

A large current may flow during startup, depending on the MOS FET selection. So perform sufficient evaluation using the actual devices. Also recommend to use a MOS FET with an input capacitance of 700 pF or less.

Since the ON-resistance of the MOS FET might depend on the difference between the output voltage (V_{OUT}) and the threshold voltage of the MOS FET, and affect the output current as well as the efficiency, the threshold voltage should be low. When the output voltage is low, the circuit operates only when the MOS FET has a threshold voltage lower than the output voltage.

4.2 Bipolar (NPN) Type

A circuit example using the CPH3210 ($h_{FE} = 200$ to 560) from Sanyo Electric Co., Ltd. As a bipolar transistor (NPN) is shown in **Figure 19 to 24** in the “■ Standard Circuits”. The h_{FE} value and R_b value of the bipolar transistor determine the driving capacity to increase the output current using a bipolar transistor. A peripheral circuit example of the transistor is shown in **Figure 18**.



*1. V_{DD} for E, G, J, K, L, M, P and Q types.

Figure 18 External Transistor Peripheral Circuit

The recommended R_b value is around $1\text{ k}\Omega$. Actually, calculate the necessary base current (I_b) from the bipolar transistor (h_{FE}) using $I_b = \frac{I_{PK}}{h_{FE}}$, and select the smaller R_b value than $R_b = \frac{V_{OUT} - 0.7}{I_b} - \frac{0.4}{|I_{EXTH}|}$ *1.

A small R_b value can increase the output current, but the efficiency decreases. Since a current may flow on the pulse and the voltage may drop due to wiring resistance or other factors in the actual circuit, therefore the optimum R_b value should be determined by experiment.

Connecting the speed-up capacitor (C_b) in parallel with the R_b resistance as shown in **Figure 18**, decreases switching loss and improves the efficiency.

The C_b value is calculated according to $C_b \leq \frac{1}{2\pi \cdot R_b \cdot f_{osc} \cdot 0.7}$.

Select a C_b value after performing sufficient evaluation since the optimum C_b value differs depending upon the characteristics of the bipolar transistor.

*1. For E, G, J, K, L, M, P and Q type, $R_b = \frac{V_{DD} - 0.7}{I_b} - \frac{0.4}{|I_{EXTH}|}$.

5. V_{DD} / V_{OUT} Separate Type (For E, G, J, K, L, M, P and Q Types)

The E, G, J, K, L, M, P and Q types provides separate internal circuit power supply (V_{DD} pin) and output voltage setting pin (V_{OUT} pin) in the IC, making it ideal for the following applications.

- (1) When changing the output voltage with external resistance.
- (2) When outputting a high voltage such as +15 V or +20 V.

Choose the products in the **Table 24** according to the applications (1) or (2) above.

Table 24

Output Voltage (V _{CC})	1.8 V ≤ V _{CC} < 5 V	5 V ≤ V _{CC}	Reference Circuit
S-835xx18	Yes	Yes	Application circuit 1 (Figure 25)
S-835xx50	–	Yes	Application circuit 1 (Figure 25)
Connection to VDD pin	V _{IN} or V _{CC}	V _{IN}	–

- Cautions**
1. This IC starts a step-up operation at V_{DD} = 0.8 V, but set 1.8 ≤ V_{DD} ≤ 10 V to stabilize the output voltage and frequency of the oscillator. (Input a voltage of 1.8 V or more at the VDD pin for all products with a setting less than 1.9 V.) An input voltage of 1.8 V or more at the VDD pin allows connection of the VDD pin to either the input voltage V_{IN} pin or output V_{OUT} pin.
 2. Choose external resistors R_A and R_B so as to not affect the output voltage, considering that there is impedance between the V_{OUT} pin and VSS pin in the IC chip. The internal resistance between the V_{OUT} pin and VSS pin is as follows :
 - (1) S-835xx18 : 2.1 to 14.8 MΩ
 - (2) S-835xx20 : 1.4 to 14.8 MΩ
 - (3) S-835xx30 : 1.4 to 14.2 MΩ
 - (4) S-835xx50 : 1.4 to 12.1 MΩ
 3. Attach a capacitor (C_C) in parallel to the R_A resistance when an unstable event such as oscillation of the output voltage occurs. Calculate C_C using the following equation :

$$C_c [F] = \frac{1}{2 \cdot \pi \cdot R_A \cdot 20 \text{ kHz}}$$

■ **Standard Circuits**

- (1) **S-8357BxxMA, S-8357BxxUA, S-8358BxxMA, S-8358BxxUA**



Remark The power supply for the IC chip is from the VOUT pin.

Figure 19

- (2) **S-8357BxxMC, S-8357FxxMC, S-8357HxxMC, S-8357NxxMC, S-8358BxxMC, S-8358FxxMC, S-8358HxxMC, S-8358NxxMC**



Remark The power supply for the IC chip is from the VOUT pin.

Figure 20

- (3) **S-8357ExxMC, S-8357GxxMC, S-8357JxxMC, S-8357PxxMC, S-8358ExxMC, S-8358GxxMC, S-8358JxxMC, S-8358PxxMC**



Remark The power supply for the IC chip is from the VDD pin.

Figure 21

- (4) S-8357ExxMC, S-8357GxxMC, S-8357JxxMC, S-8358ExxMC, S-8358GxxMC, S-8358JxxMC



Remark The power supply for the IC chip is from the VDD pin.

Figure 22

- (5) S-8355KxxMC, S-8355LxxMC, S-8355MxxMC, S-8355QxxMC, S-8356KxxMC, S-8356LxxMC, S-8356MxxMC, S-8356QxxMC



Remark The power supply for the IC chip is from the VDD pin.

Figure 23

- (6) S-8355KxxMC, S-8355LxxMC, S-8355MxxMC, S-8356KxxMC, S-8356LxxMC, S-8356MxxMC



Remark The power supply for the IC chip is from the VDD pin.

Figure 24

Caution The above connection diagram and constant will not guarantee successful operation. Perform through evaluation using the actual application to set the constant.

■ Precautions

- Mount external capacitors, the diode, and the coil as close as possible to the IC.
- Characteristics ripple voltage and spike noise occur in IC containing switching regulators. Moreover rush current flows at the time of a power supply injection. Because these largely depend on the coil, the capacitor and impedance of power supply used, fully check them using an actually mounted model.
- Make sure that the dissipation of the switching transistor (especially at a high temperature) does not exceed the allowable power dissipation of the package.
- The performance of this IC varies depending on the design of the PCB patterns, peripheral circuits and external parts. Thoroughly test all settings with your device. Also, try to use the recommended external parts. If not, contact an ABLIC Inc. sales person.
- Do not apply an electrostatic discharge to this IC that exceeds the performance ratings of the built-in electrostatic protection circuit.
- ABLIC Inc. claims no responsibility for any disputes arising out of or in connection with any infringement by products including this IC of patents owned by a third party.

■ Application Circuits

1. LCD Power Supply

The following example is an application power supply circuit (15 V / 20 V output) to drive an LCD panel, and its characteristics.



Figure 25 Power Supply Circuit Example for LCD

Table 25

Condition	Output Voltage	IC	L Type Name	TR Type Name	SD Type Name	C _L	R _a	R _b	C _c
1	15 V	S-8356M50	CDRH5D18-220	MCH3405	MA2Z748	F93 (20 V, 10 μF)	580 kΩ	300 kΩ	15 pF
2	20 V	S-8356M50	CDRH5D18-220	FDN337N	MA729	F93 (25 V, 10 μF)	575 kΩ	200 kΩ	15 pF
3	10 V	S-8356Q50	CDRH5D18-100	MCH3405	MA2Z748	F93 (20 V, 10 μF)	560 kΩ	560 kΩ	15 pF

Caution The above connection diagram and constant will not guarantee successful operation. Perform through evaluation using the actual application to set the constant.

2. Output Characteristics of The Power Supply for LCD

The data of the step-up characteristics (a) Output current (I_{OUT}) vs. Efficiency (η) characteristics, (b) Output current (I_{OUT}) vs. Output voltage (V_{OUT}) characteristics under conditions of 1 to 3 in **Table 25** is shown below.

Condition 1

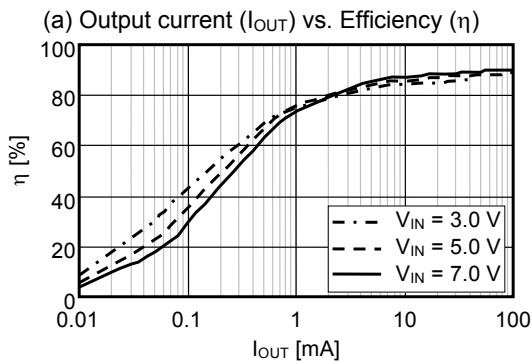

Condition 2



Condition 3



3. Using Ceramic Capacitor Example

When using small R_{ESR} parts such as ceramic capacitors for the output capacitance, mount a resistor (R_1) corresponding to the R_{ESR} in series with the ceramic capacitor (C_L) as shown in **Figure 26**. R_1 differs depending on “L” value, the capacitance, the wiring, and the application (output load). The following example shows a circuit using $R_1 = 100\text{ m}\Omega$, output voltage = 3.3 V, output load = 500 mA and its characteristics.



Figure 26 Using Ceramic Capacitor Circuit Example

Table 26

Condition	IC	L Type Name	TR Type Name	SD Type Name	SD Type Name	R_1
1	S-8357F33	CDRH6D28-220	FDN335N	M1FH3	10 $\mu\text{F} \times 2$	100 m Ω
2	S-8358B50	CDRH6D28-470	FDN335N	M1FH3	10 $\mu\text{F} \times 2$	100 m Ω
3	S-8357N33	CDRH6D28-100	FDN335N	M1FH3	10 $\mu\text{F} \times 2$	100 m Ω

Caution The above connection diagram and constant will not guarantee successful operation. Perform through evaluation using the actual application to set the constant.

4. Output Characteristics of The Using Ceramic Capacitor Circuit Example

The data of the step-up characteristics (a) Output current (I_{OUT}) vs. Efficiency (η) characteristics, (b) Output current (I_{OUT}) vs. Output voltage (V_{OUT}) characteristics, (c) Output Current (I_{OUT}) vs. Ripple voltage (V_r) under conditions of 1 to 3 in **Table 26** is shown below.

Condition 1



Condition 2



Condition 3



■ **Characteristics (Typical Data)**

1. Example of Major Temperature characteristics (Ta = -40 to +85 °C)

(1) Current Consumption 1 (I_{SS1}) vs. Temperature (Ta) (V_{OUT} = 3.3 V)



(2) Current Consumption 2 (I_{SS2}) vs. Temperature (Ta) (V_{OUT} = 3.3 V)

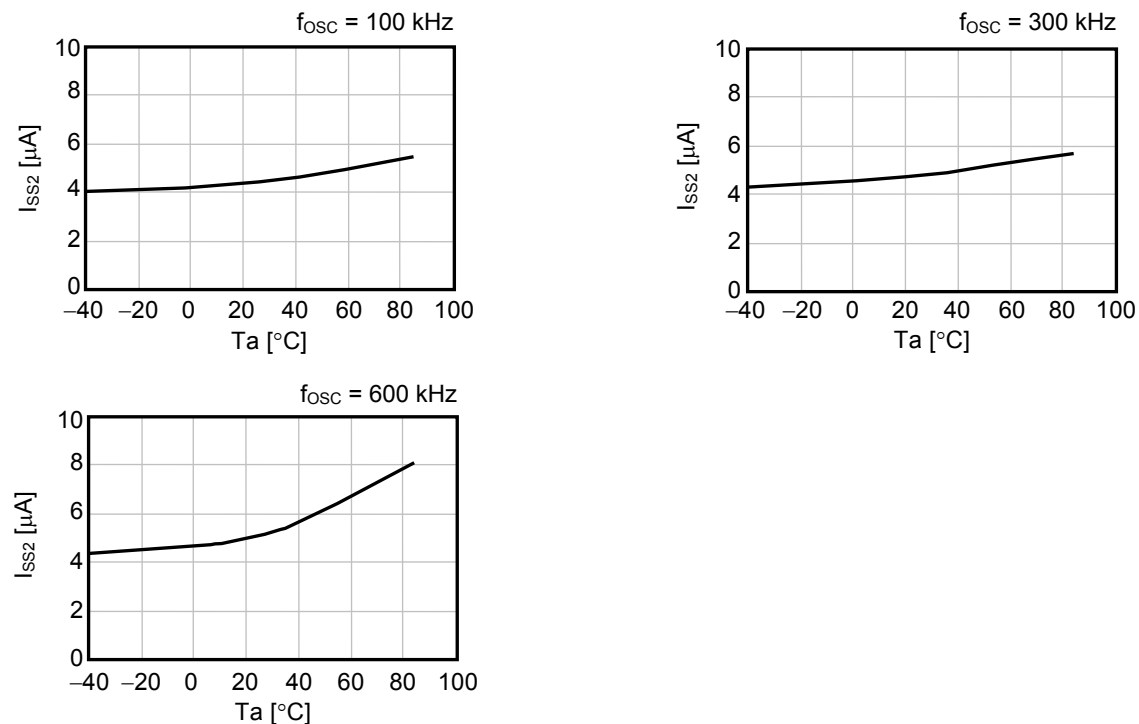

(3) Current Consumption at Shutdown (I_{SS}) vs. Temperature (T_a)



(4) EXT Pin Output Current "H" (I_{EXTH}) vs. Temperature (T_a)



(5) EXT Pin Output Current "L" (I_{EXTL}) vs. Temperature (T_a)



(6) Oscillation Frequency (f_{OSC}) vs. Temperature (T_a) ($V_{OUT} = 3.3 \text{ V}$)



(7) Maximum Duty Ratio (MaxDuty) vs. Temperature (Ta) (V_{OUT} = 3.3 V)



(8) PWM / PFM Switching Duty Ratio (PFMDuty) vs. Temperature (Ta) (S-8356/58 Series)



(9) ON/OFF Pin Input Voltage "H" (V_{SH}) vs. Temperature (Ta)



(10) ON/OFF Pin Input Voltage "L" 1 (V_{SL1}) vs. Temperature (Ta)

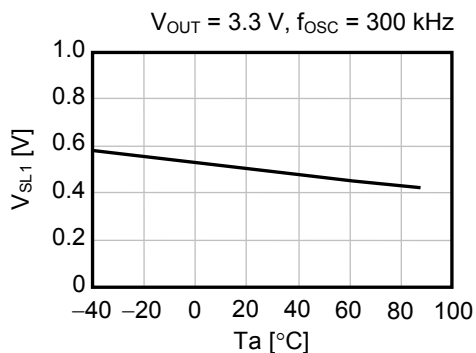

(11) ON/OFF Pin Input Voltage "L" 2 (V_{SL2}) vs. Temperature (Ta)



(12) Soft Start Time (t_{SS}) vs. Temperature (T_a) ($V_{OUT} = 3.3\text{ V}$)



(13) Operation Start Voltage (V_{ST1}) vs. Temperature (T_a)

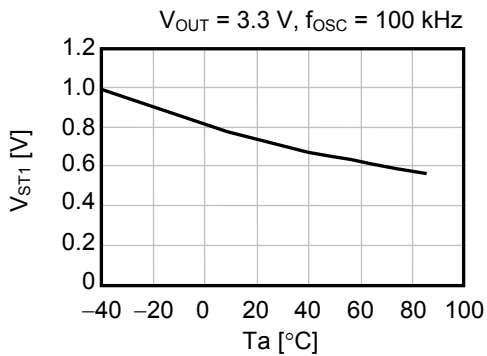

(14) Oscillation Start Voltage (V_{ST2}) vs. Temperature (T_a)

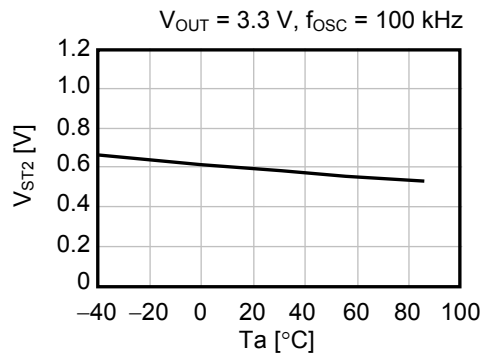

(15) Output Voltage (V_{OUT}) vs. Temperature (T_a) ($V_{OUT} = 3.3\text{ V}$)



2. Examples of Major Power Supply Dependence Characteristics (Ta = 25 °C)

(1) Current Consumption 1 (I_{SS1}) vs. Power Supply Voltage (V_{DD}), Current Consumption 2 (I_{SS2}) vs. Power Supply Voltage (V_{DD}) ($V_{OUT} = 3.3 V$)



(2) Current Consumption at Shutdown (I_{SSS}) vs. Power Supply Voltage (V_{DD})



(3) Oscillation Frequency (f_{OSC}) vs. Power Supply Voltage (V_{DD})



(4) Maximum Duty Ratio (MaxDuty) vs. Power Supply Voltage (V_{DD})



(5) EXT Pin Output Current "H" (I_{EXTH}) vs. Power Supply Voltage (V_{DD})



(6) EXT Pin Output Current "L" (I_{EXTL}) vs. Power Supply Voltage (V_{DD})



(7) Output Voltage (V_{OUT}) vs. Power Supply Voltage (V_{DD}) (V_{DD} Separate Type, $V_{OUT} = 3.3\text{ V}$, $V_{IN} = 1.98\text{ V}$, $I_{OUT} = 66\text{ mA}$)



3. Output Waveforms

(1) S-8358B33MC



(2) S-8358F33MC

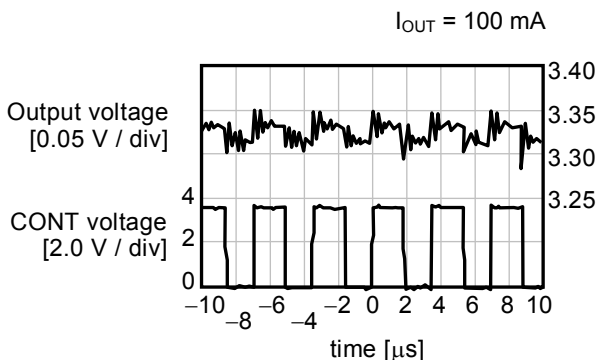

(3) S-8358N33MC



4. Examples of Transient Response Characteristics

(1) Power-On ($V_{IN} : 0\text{ V} \rightarrow 2\text{ V}$)

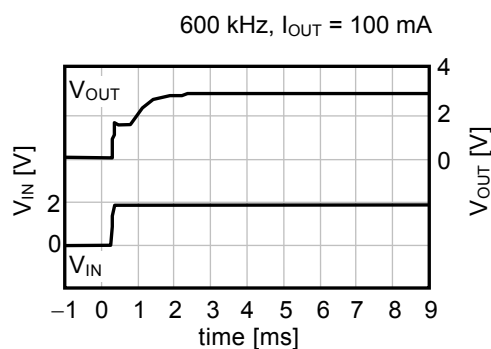
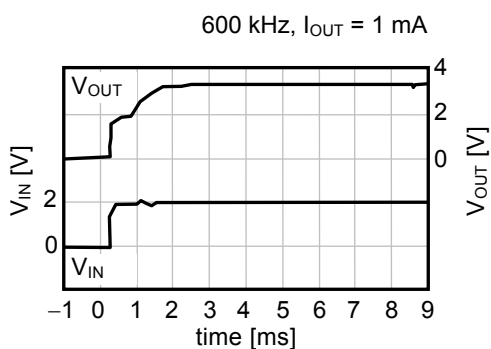
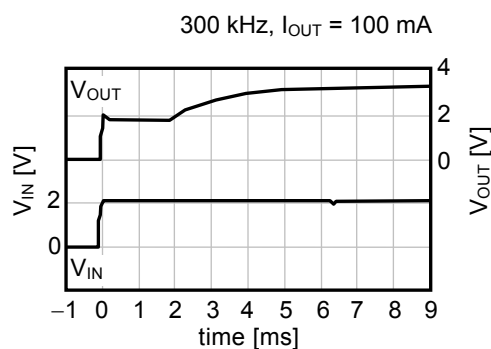
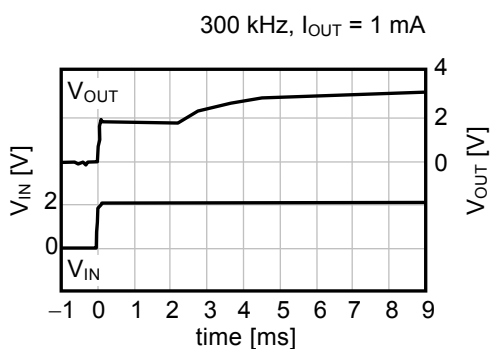
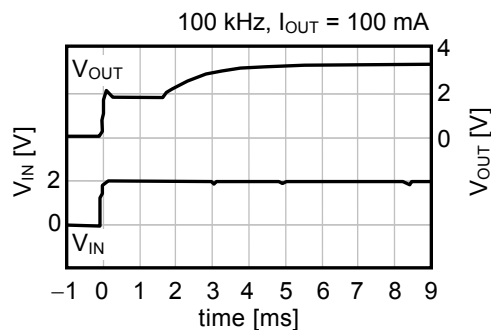
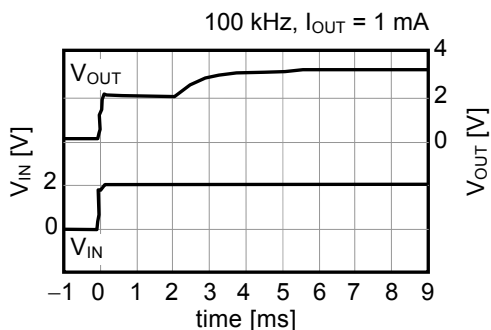

(2) ON/OFF Pin Response ($V_{ON/OFF} : 0\text{ V} \rightarrow 2.0\text{ V}$)



(3) Load Fluctuations



(4) Input Voltage Fluctuations ($I_{OUT} = 100 \text{ mA}$)



■ Reference Data

Use this reference data to choose the external parts. This reference data makes it possible to choose the recommended external part based on the application and characteristics data.

1. External Parts for Reference Data

Table 27 Efficiency vs. Output Current Characteristics and Output Voltage vs. Output Current Characteristics for External

Condition	Product Name	Oscillation Frequency	Output Voltage	Control System	Inductor	Transistor	Diode	Output capacitor
1	S-8357F33	300 kHz	3.3 V	PWM	CDRH104R-220	FDN335N	M1FH3	F93 (16 V, 47 μF) × 2
2	S-8357F50	300 kHz	5.0 V	PWM				
3	S-8356M50	300 kHz	5.0 V	PWM/PFM				
4	S-8357B33	100 kHz	3.3 V	PWM	CDRH104R-470			
5	S-8358B33	100 kHz	3.3 V	PWM/PFM				
6	S-8357B50	100 kHz	5.0 V	PWM				
7	S-8356M50	300 kHz	5.0 V	PWM/PFM	CDRH8D28-220			F93 (16 V, 47 μF)
8	S-8357B33	100 kHz	3.3 V	PWM	CDRH8D28-470			
9	S-8358B33	100 kHz	3.3 V	PWM/PFM				
10	S-8357B50	100 kHz	5.0 V	PWM				
11	S-8357F33	300 kHz	3.3 V	PWM	CXLP120-220	MCH3405	MA2Z748	F92 (6.3 V, 47 μF)
12	S-8356M50	300 kHz	5.0 V	PWM/PFM				
13	S-8357N33	600 kHz	3.3 V	PWM	CDRH8D28-100	FDN335N	M1FH3	F93 (16 V, 47 μF)
14	S-8357N50	600 kHz	5.0 V	PWM				
15	S-8356Q33	600 kHz	3.3 V	PWM/PFM				
16	S-8356Q50	600 kHz	5.0 V	PWM/PFM				

The properties of the external parts are shown below.

Table 28 Properties of External Parts

Component	Product Name	Manufacturer	Characteristics
Inductor	CDRH104R-220	Sumida Corporation	22 μ H, DCR ^{*1} = 73 m Ω , I _{MAX} ^{*2} = 2.5 A, Component height = 4.0 mm
	CDRH104R-470		47 μ H, DCR ^{*1} = 128 m Ω , I _{MAX} ^{*2} = 1.9 A, Component height = 4.0 mm
	CDRH8D28-100		10 μ H, DCR ^{*1} = 47 m Ω , I _{MAX} ^{*2} = 2.7 A, Component height = 3.0 mm
	CDRH8D28-220		22 μ H, DCR ^{*1} = 99 m Ω , I _{MAX} ^{*2} = 1.8 A, Component height = 3.0 mm
	CDRH8D28-470		47 μ H, DCR ^{*1} = 195 m Ω , I _{MAX} ^{*2} = 1.25 A, Component height = 3.0 mm
	CXLP120-220	Sumitomo Special Metals Co., Ltd.	22 μ H, DCR ^{*1} = 590 m Ω , I _{MAX} ^{*2} = 0.55 A, Component height = 1.2 mm
Diode	M1FH3	Shindengen Electric Manufacturing Co., Ltd.	V _F ^{*3} = 0.3 V, I _F ^{*4} = 1.5 A
	MA2Z748	Matsushita Electric Industrial Co., Ltd.	V _F ^{*3} = 0.4 V, I _F ^{*4} = 0.3 A
Capacitor (Output Capacitance)	F93	Nichicon Corporation	16 V, 47 μ F
	F92		6.3 V, 47 μ F
Transistor (Nch FET)	FDN335N	Fairchild Semiconductor Japan Ltd.	V _{DSS} ^{*5} = 20 V max., V _{GSS} ^{*6} = 8 V max., C _{ISS} ^{*7} = 310 pF, I _D ^{*8} = 1.5 A (V _{GS} ^{*6} = 2.5 V)
	MCH3405	Sanyo Electric Co., Ltd.	V _{DSS} ^{*5} = 20 V max., V _{GSS} ^{*6} = 10 V max., C _{ISS} ^{*7} = 280 pF, I _D ^{*8} = 0.5 A (V _{GS} ^{*6} = 1.8 V)

- *1. Direct current resistance
- *2. Maximum allowable current
- *3. Forward voltage
- *4. Forward current
- *5. Drain source voltage
- *6. Gate source voltage
- *7. Input capacitance
- *8. Drain current

Caution The values shown in the characteristics column of Table 28 above are based on the materials provided by each manufacture. However, consider the characteristics of the original materials when using the above products.

2. Output Current (I_{OUT}) vs. Efficiency (η) Characteristics, Output Current (I_{OUT}) vs. Output Voltage (V_{OUT}) Characteristics

The following shows the actual (a) Output current (I_{OUT}) vs. Efficiency (η) characteristics and (b) Output current (I_{OUT}) vs. Output voltage (V_{OUT}) characteristics under the conditions of No. 1 to 16 in **Table 27**.

Condition 1 S-8357F33

(a) Output current (I_{OUT}) vs. Efficiency (η)



(b) Output current (I_{OUT}) vs. Output voltage (V_{OUT})

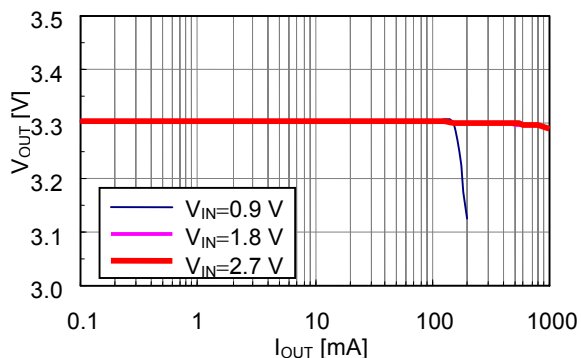

Condition 2 S-8357F50

(a) Output current (I_{OUT}) vs. Efficiency (η)



(b) Output current (I_{OUT}) vs. Output voltage (V_{OUT})

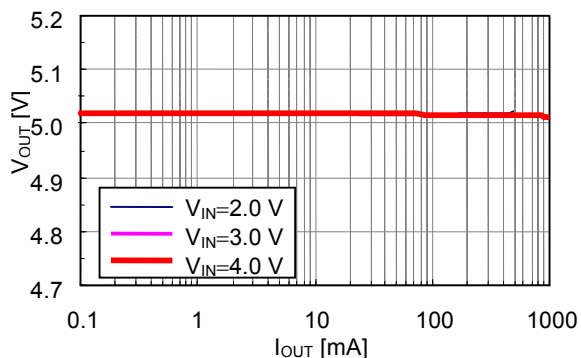

Condition 3 S-8356M50

(a) Output current (I_{OUT}) vs. Efficiency (η)



(b) Output current (I_{OUT}) vs. Output voltage (V_{OUT})

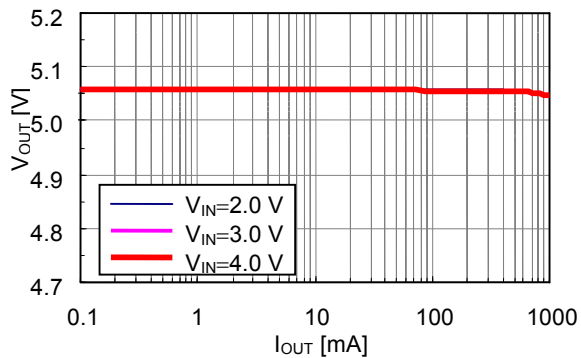

Condition 4 S-8357B33

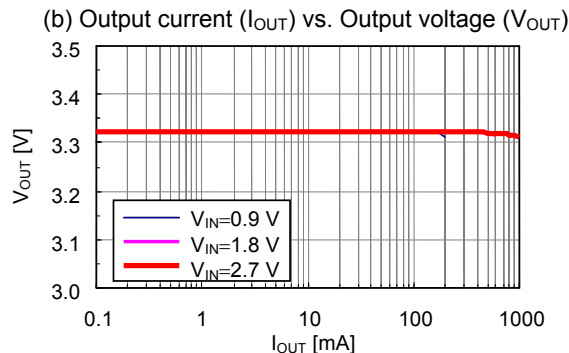

Condition 5 S-8358B33



Condition 6 S-8357B50



Condition 7 S-8357M50



Condition 8 S-8357B33



Condition 9 S-8358B33

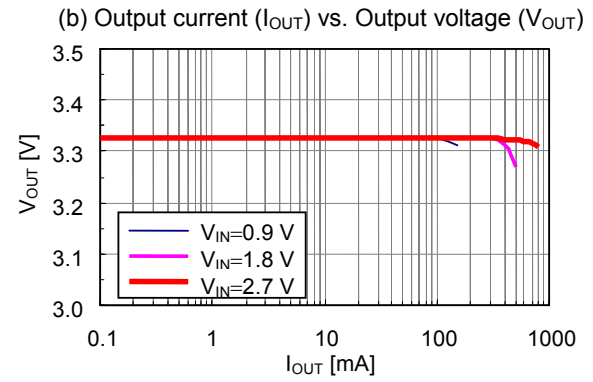
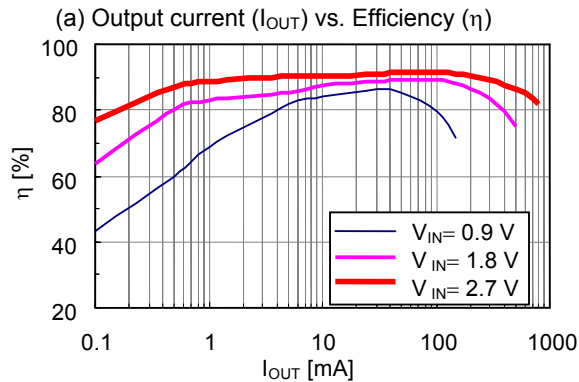

Condition 10 S-8357B50

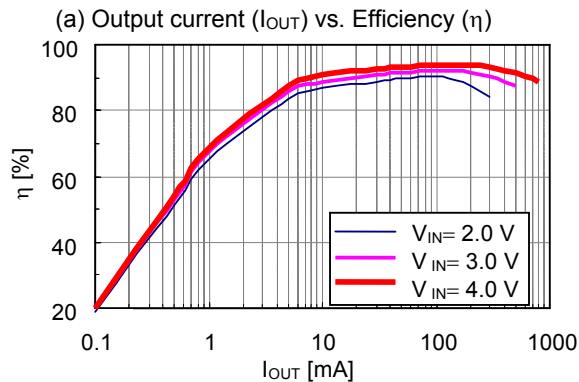

Condition 11 S-8357F33

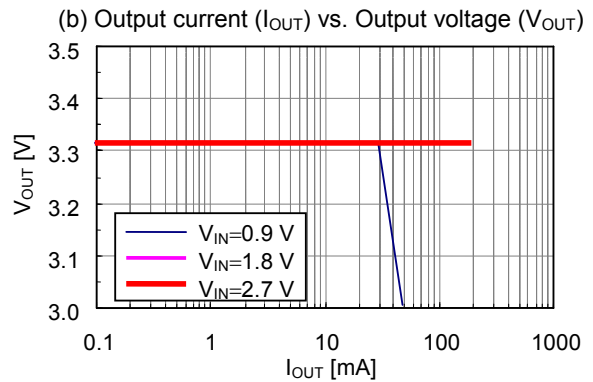
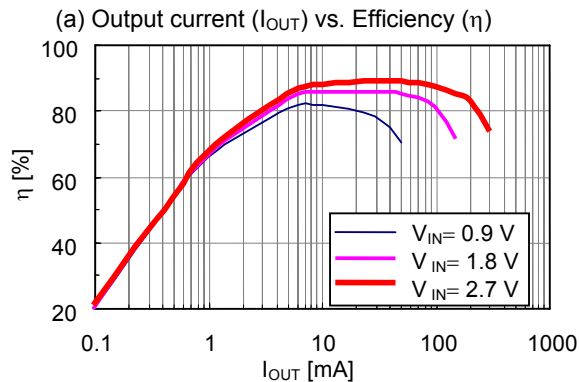

Condition 12 S-8356M50



Condition 13 S-8357N33



Condition 14 S-8357N50



Condition 15 S-8356Q33



Condition 16 S-8356Q50



3. Output Current (I_{OUT}) vs. Ripple Voltage (V_r) Characteristics

The following shows the actual Output current (I_{OUT}) vs. Ripple voltage (V_r) characteristics and (b) Output current (I_{OUT}) vs. Output voltage (V_{OUT}) characteristics under the conditions of No. 1 to 16 in Table 27.

Condition 1 S-8357F33



Condition 2 S-8357F50

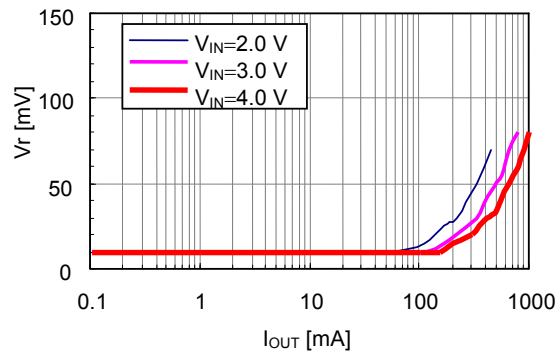

Condition 3 S-8356M50



Condition 4 S-8357B33

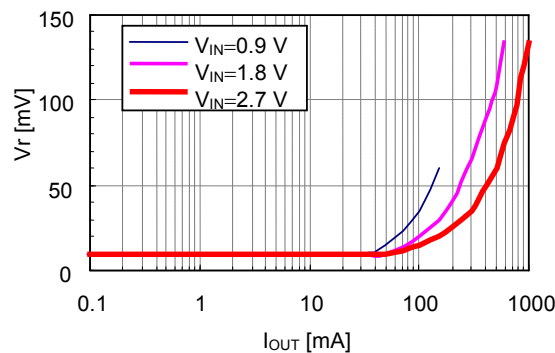

Condition 5 S-8358B33

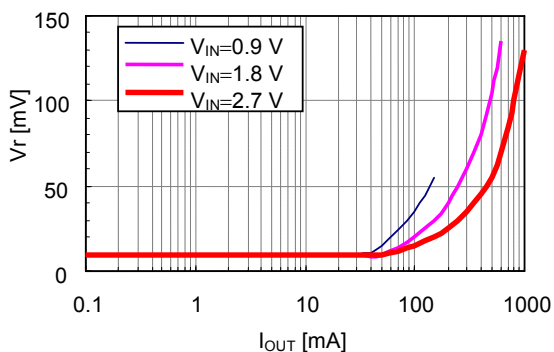

Condition 6 S-8357B50

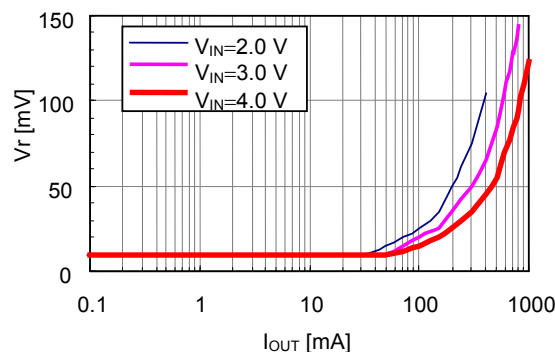

Condition 7 S-8356M50

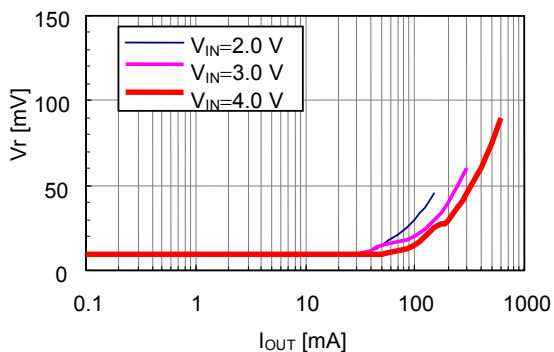

Condition 8 S-8357B33

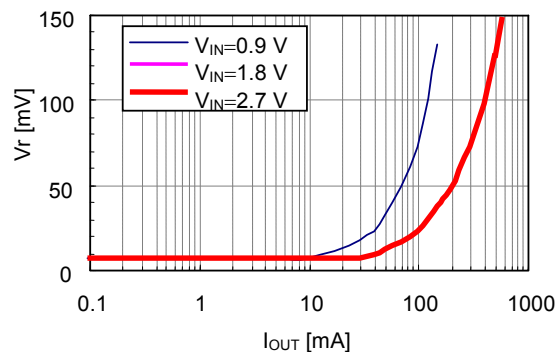

Condition 9 S-8358B33

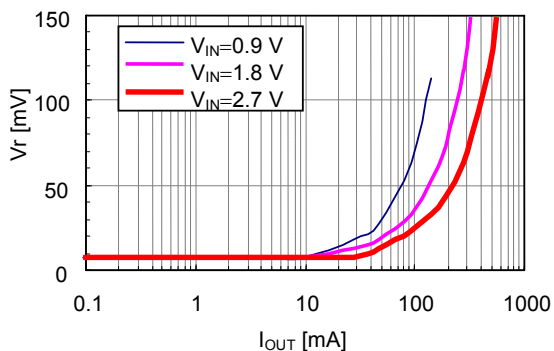

Condition 10 S-8357B50

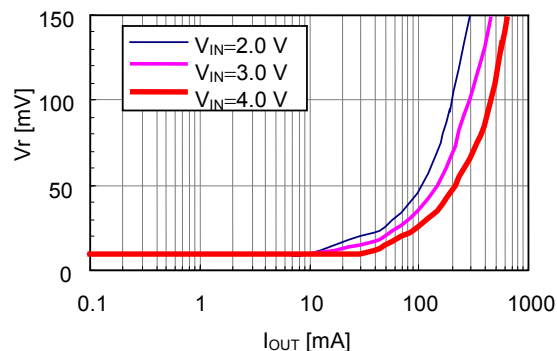

Condition 11 S-8357F33

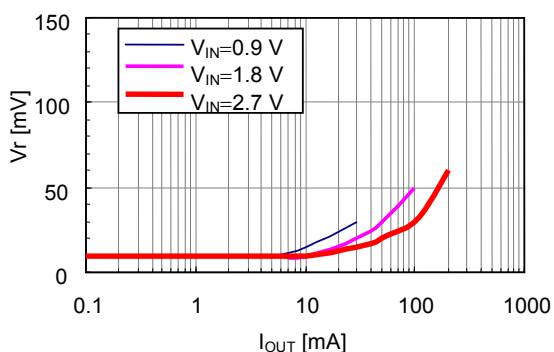

Condition 12 S-8356M50

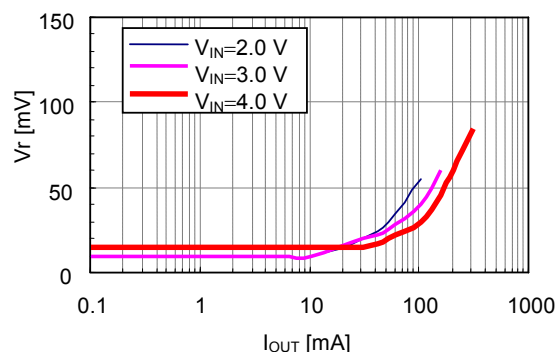

Condition 13 S-8357N33

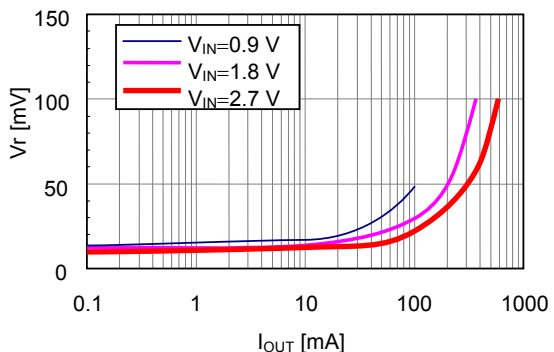

Condition 14 S-8357N50

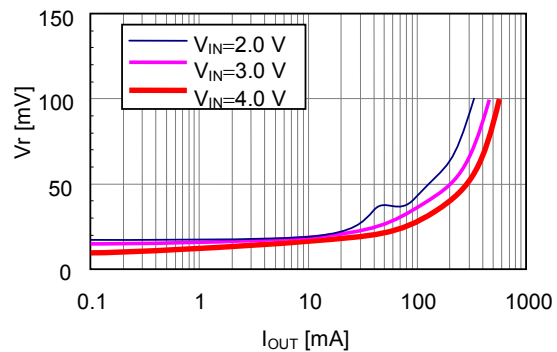

Condition 15 S-8356Q33

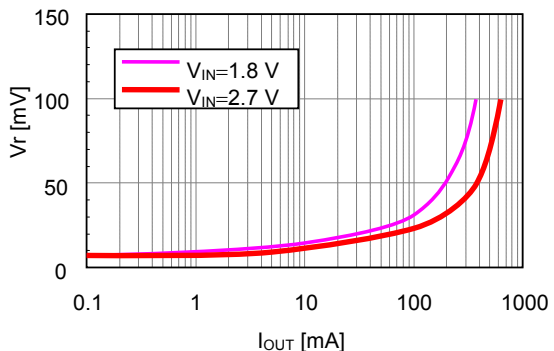

Condition 16 S-8356Q50

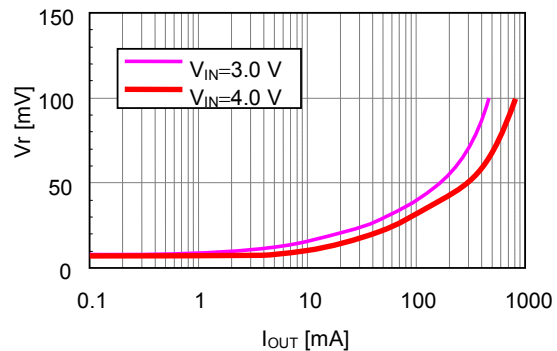



No. MP003-A-P-SD-1.2

TITLE	SOT233-A-PKG Dimensions
No.	MP003-A-P-SD-1.2
ANGLE	
UNIT	mm
ABLIC Inc.	



→
Feed direction

No. MP003-A-C-SD-2.0

TITLE	SOT233-A-Carrier Tape
No.	MP003-A-C-SD-2.0
ANGLE	
UNIT	mm
ABLIC Inc.	



Enlarged drawing in the central part



No. MP003-A-R-SD-1.1

TITLE	SOT233-A-Reel		
No.	MP003-A-R-SD-1.1		
ANGLE		QTY.	3,000
UNIT	mm		
ABLIC Inc.			



No. MP005-A-P-SD-1.3

TITLE	SOT235-A-PKG Dimensions
No.	MP005-A-P-SD-1.3
ANGLE	
UNIT	mm
ABLIC Inc.	



Feed direction →

No. MP005-A-C-SD-2.1

TITLE	SOT235-A-Carrier Tape
No.	MP005-A-C-SD-2.1
ANGLE	
UNIT	mm
ABLIC Inc.	



Enlarged drawing in the central part



No. MP005-A-R-SD-1.1

TITLE	SOT235-A-Reel		
No.	MP005-A-R-SD-1.1		
ANGLE		QTY.	3,000
UNIT	mm		
ABLIC Inc.			



No. UP003-A-P-SD-2.0

TITLE	SOT893-A-PKG Dimensions
No.	UP003-A-P-SD-2.0
ANGLE	
UNIT	mm

ABLIC Inc.



Feed direction →

No. UP003-A-C-SD-2.0

TITLE	SOT893-A-Carrier Tape
No.	UP003-A-C-SD-2.0
ANGLE	
UNIT	mm
ABLIC Inc.	



Enlarged drawing in the central part



No. UP003-A-R-SD-1.1

TITLE	SOT893-A-Reel		
No.	UP003-A-R-SD-1.1		
ANGLE		QTY.	1,000
UNIT	mm		
ABLIC Inc.			

Disclaimers (Handling Precautions)

1. All the information described herein (product data, specifications, figures, tables, programs, algorithms and application circuit examples, etc.) is current as of publishing date of this document and is subject to change without notice.
2. The circuit examples and the usages described herein are for reference only, and do not guarantee the success of any specific mass-production design.
ABLIC Inc. is not liable for any losses, damages, claims or demands caused by the reasons other than the products described herein (hereinafter "the products") or infringement of third-party intellectual property right and any other right due to the use of the information described herein.
3. ABLIC Inc. is not liable for any losses, damages, claims or demands caused by the incorrect information described herein.
4. Be careful to use the products within their ranges described herein. Pay special attention for use to the absolute maximum ratings, operation voltage range and electrical characteristics, etc.
ABLIC Inc. is not liable for any losses, damages, claims or demands caused by failures and / or accidents, etc. due to the use of the products outside their specified ranges.
5. Before using the products, confirm their applications, and the laws and regulations of the region or country where they are used and verify suitability, safety and other factors for the intended use.
6. When exporting the products, comply with the Foreign Exchange and Foreign Trade Act and all other export-related laws, and follow the required procedures.
7. The products are strictly prohibited from using, providing or exporting for the purposes of the development of weapons of mass destruction or military use. ABLIC Inc. is not liable for any losses, damages, claims or demands caused by any provision or export to the person or entity who intends to develop, manufacture, use or store nuclear, biological or chemical weapons or missiles, or use any other military purposes.
8. The products are not designed to be used as part of any device or equipment that may affect the human body, human life, or assets (such as medical equipment, disaster prevention systems, security systems, combustion control systems, infrastructure control systems, vehicle equipment, traffic systems, in-vehicle equipment, aviation equipment, aerospace equipment, and nuclear-related equipment), excluding when specified for in-vehicle use or other uses by ABLIC, Inc. Do not apply the products to the above listed devices and equipments.
ABLIC Inc. is not liable for any losses, damages, claims or demands caused by unauthorized or unspecified use of the products.
9. In general, semiconductor products may fail or malfunction with some probability. The user of the products should therefore take responsibility to give thorough consideration to safety design including redundancy, fire spread prevention measures, and malfunction prevention to prevent accidents causing injury or death, fires and social damage, etc. that may ensue from the products' failure or malfunction.
The entire system in which the products are used must be sufficiently evaluated and judged whether the products are allowed to apply for the system on customer's own responsibility.
10. The products are not designed to be radiation-proof. The necessary radiation measures should be taken in the product design by the customer depending on the intended use.
11. The products do not affect human health under normal use. However, they contain chemical substances and heavy metals and should therefore not be put in the mouth. The fracture surfaces of wafers and chips may be sharp. Be careful when handling these with the bare hands to prevent injuries, etc.
12. When disposing of the products, comply with the laws and ordinances of the country or region where they are used.
13. The information described herein contains copyright information and know-how of ABLIC Inc. The information described herein does not convey any license under any intellectual property rights or any other rights belonging to ABLIC Inc. or a third party. Reproduction or copying of the information from this document or any part of this document described herein for the purpose of disclosing it to a third-party is strictly prohibited without the express permission of ABLIC Inc.
14. For more details on the information described herein or any other questions, please contact ABLIC Inc.'s sales representative.
15. This Disclaimers have been delivered in a text using the Japanese language, which text, despite any translations into the English language and the Chinese language, shall be controlling.

2.4-2019.07

Mouser Electronics

Authorized Distributor

Click to View Pricing, Inventory, Delivery & Lifecycle Information:

ABLIC:

[S-8356M50MC-MFJT2G](#) [S-8358B33MC-NQST2G](#) [S-8357F33MC-MGST2G](#) [S-8357B33MC-NIST2G](#) [S-8355K18MC-NADT2G](#) [S-8355M18MC-MCDT2G](#) [S-8356M18MC-MEDT2G](#) [S-8356K18MC-NEDT2G](#) [S-8358G50MC-MNJT2G](#) [S-8357G50MC-MJJT2G](#) [S-8357B50MC-NJJT2G](#) [S-8357F50MC-MHJT2G](#) [S-8355K20MC-NAFT2G](#) [S-8355K31MC-NAQT2G](#) [S-8355K33MC-NAST2G](#) [S-8355K50MC-NBJT2G](#) [S-8355L15MC-NCAT2G](#) [S-8355L20MC-NCFT2G](#) [S-8355M20MC-MCFT2G](#) [S-8355M31MC-MCQT2G](#) [S-8355M32MC-MCRT2G](#) [S-8355M34MC-MCTT2G](#) [S-8355M50MC-MDJT2G](#) [S-8355M55MC-MDOT2G](#) [S-8355Q15MC-OWAT2G](#) [S-8355Q50MC-OXJT2G](#) [S-8356K50MC-NFJT2G](#) [S-8356M15MC-MEAT2G](#) [S-8356M30MC-MEPT2G](#) [S-8356Q18MC-OYDT2G](#) [S-8356Q33MC-OYST2G](#) [S-8356Q50MC-OVJT2G](#) [S-8357B25MC-NIKT2G](#) [S-8357B26MC-NILT2G](#) [S-8357B27MC-NIMT2G](#) [S-8357B28MC-NINT2G](#) [S-8357B30MA-NIPT2G](#) [S-8357B30MC-NIPT2G](#) [S-8357B33MA-NIST2G](#) [S-8357B33UA-NIST2G](#) [S-8357B36MC-NIVT2G](#) [S-8357B48MC-NJHT2G](#) [S-8357B48UA-NJHT2G](#) [S-8357B50MA-NJJT2G](#) [S-8357B50UA-NJJT2G](#) [S-8357B52MC-NJLT2G](#) [S-8357B54MC-NJNT2G](#) [S-8357B60MC-NJTT2G](#) [S-8357E15MC-NKAT2G](#) [S-8357E20MC-NKFT2G](#) [S-8357E50MC-NLJT2G](#) [S-8357F32MC-MGRT2G](#) [S-8357F52MC-MHLT2G](#) [S-8357H30MC-NMPT2G](#) [S-8357H31MC-NMQT2G](#) [S-8357H35MC-NMUT2G](#) [S-8357H36MC-NMVT2G](#) [S-8357H50MC-NNJT2G](#) [S-8357J25MC-NOKT2G](#) [S-8357J50MC-NPJT2G](#) [S-8357N33MC-O2ST2G](#) [S-8357N50MC-O3JT2G](#) [S-8358B23MC-NQIT2G](#) [S-8358B25MC-NQKT2G](#) [S-8358B26MC-NQLT2G](#) [S-8358B27MC-NQMT2G](#) [S-8358B30MC-NQPT2G](#) [S-8358B31MC-NQQT2G](#) [S-8358B32MC-NQRT2G](#) [S-8358B33UA-NQST2G](#) [S-8358B35MC-NQUT2G](#) [S-8358B36MC-NQVT2G](#) [S-8358B38MC-NQXT2G](#) [S-8358B40MC-NQZT2G](#) [S-8358B50MA-NRJT2G](#) [S-8358B50MC-NRJT2G](#) [S-8358B50UA-NRJT2G](#) [S-8358B60MC-NRTT2G](#) [S-8358E20MC-NSFT2G](#) [S-8358E50MC-NTJT2G](#) [S-8358F26MC-MKLT2G](#) [S-8358F27MC-MKMT2G](#) [S-8358F33MC-MKST2G](#) [S-8358F50MC-MLJT2G](#) [S-8358F53MC-MLMT2G](#) [S-8358H23MC-NUIT2G](#) [S-8358H30MC-NUPT2G](#) [S-8358H33MC-NUST2G](#) [S-8358H50MC-NVJT2G](#) [S-8358J33MC-NWST2G](#) [S-8358J50MC-NXJT2G](#) [S-8358N53MC-O7MT2G](#) [S-8356Q40MC-OYZT2G](#) [S-8355M60MC-MDTT2G](#) [S-8355M65MC-MDYT2G](#) [S-8355Q18MC-OWDT2G](#) [S-8355Q20MC-OWFT2G](#) [S-8355Q45MC-OXET2G](#) [S-8355Q51MC-OXKT2G](#) [S-8355Q60MC-OXTT2G](#)



Компания «ЭлектроПласт» предлагает заключение долгосрочных отношений при поставках импортных электронных компонентов на взаимовыгодных условиях!

Наши преимущества:

- Оперативные поставки широкого спектра электронных компонентов отечественного и импортного производства напрямую от производителей и с крупнейших мировых складов;
- Поставка более 17-ти миллионов наименований электронных компонентов;
- Поставка сложных, дефицитных, либо снятых с производства позиций;
- Оперативные сроки поставки под заказ (от 5 рабочих дней);
- Экспресс доставка в любую точку России;
- Техническая поддержка проекта, помощь в подборе аналогов, поставка прототипов;
- Система менеджмента качества сертифицирована по Международному стандарту ISO 9001;
- Лицензия ФСБ на осуществление работ с использованием сведений, составляющих государственную тайну;
- Поставка специализированных компонентов (Xilinx, Altera, Analog Devices, Intersil, Interpoint, Microsemi, Aeroflex, Peregrine, Syfer, Eurofarad, Texas Instrument, Miteq, Cobham, E2V, MA-COM, Hittite, Mini-Circuits, General Dynamics и др.);

Помимо этого, одним из направлений компании «ЭлектроПласт» является направление «Источники питания». Мы предлагаем Вам помощь Конструкторского отдела:

- Подбор оптимального решения, техническое обоснование при выборе компонента;
- Подбор аналогов;
- Консультации по применению компонента;
- Поставка образцов и прототипов;
- Техническая поддержка проекта;
- Защита от снятия компонента с производства.



Как с нами связаться

Телефон: 8 (812) 309 58 32 (многоканальный)

Факс: 8 (812) 320-02-42

Электронная почта: org@eplast1.ru

Адрес: 198099, г. Санкт-Петербург, ул. Калинина, дом 2, корпус 4, литера А.