

The products listed in this catalog are only a few of the thousands of variations that TUSONIX produces. For custom component design, please contact the factory direct.

Catalog 4000R7
Part 1
Revised 4/10/07



TUSONIX Capabilities

Manufacturing

TUSONIX utilizes more than 120,000 square feet (11,150 square meters) of manufacturing space, dedicated to providing high quality EMI/RFI products.

In addition to the standard catalog items, TUSONIX has numerous variations of these designs and can custom design a part to meet your particular specifications. TUSONIX maintains a staff of highly skilled Customer Engineers to assist our customers in the design of custom products.

Meeting Customer Requirements

Headquartered in Tucson, Arizona, TUSONIX is devoted to bringing the company's broad product line to an ever expanding world market.

TUSONIX has more than five decades of efficient manufacturing expertise in its corporate heritage, and utilizes sophisticated equipment to provide customers with attractive pricing and full value for the products they purchase.

Circuits Available in this Catalog



TUSONIX Quality Objective

The timely delivery of quality products which exceed our customers' expectations through the use of effective teamwork and the process of continuous improvement.

TUSONIX Quality

Quality is the key ingredient in all TUSONIX products with approval to MIL-PRF-15733, MIL-PRF-81 and MIL-C-11015. TUSONIX maintains a fully approved Quality Assurance laboratory and relies heavily on Statistical Process Control to monitor critical operations.

TUSONIX

7741 North Business Park Drive
Tucson, Arizona 85743

Ph: 520-744-0400 Fax: 520-744-6155

Website: www.tusonix.com

E-mail: sales@tusonix.com

Providing Excellence in EMI/RFI Filtering Components...

TUSONIX, Inc. manufactures thousands of EMC Products featuring an extensive line of EMI/RFI Filters and Capacitors.

We combine Technology, Expertise, Versatility and Innovation to produce the industry's most complete line of ceramic EMI/RFI Filters.

TUSONIX draws upon its 50+ years of manufacturing expertise and an accumulated base of ceramic dielectric technology to provide an ever expanding line of EMI/RFI Filters and Capacitors.

Tusonix products not only set the industry standard but lead the way in the development of tomorrow's EMI Technology.



Contents

Capacitors	3-4
Solder Mount Filters	5-7, 11-12
Press-In Filters	8-10
Bushing Mount Filters	13-23
4-40 Thread	13-14
6-40 Thread	15
6-32 Thread	16
8-32 Thread	17-18
8-36 Thread	19
12-28 Thread	19
12-32 Thread	20
1/4-28 Thread	21
5/16-24 Thread	21
5/16-32 Thread	21
High Voltage	21
Metric Thread	22
Mil Cross Reference	15
Coaxial Broadband	23-24
Standard Hardware Dimensions	24
Installation Recommendations	25
EIA/Tusonix Tolerance Codes	25
General Test Specifications	26

How to use this Catalog

This Catalog identifies standard parts produced by TUSONIX. Part numbers are listed in sections by mounting style (Solder Mount or Bushing Mount). Bushing parts are listed by circuit configuration and arranged in ascending order with respect to voltage rating at 125°C and then capacitance value.

FILTERS

Filters are assigned a four digit style number followed by a three digit variation number. (Example: 4100-003)

FEED-THRU CAPACITORS

Feed-thru capacitors are assigned a three or four digit style number followed by a three digit variation number, then the EIA Code for temperature characteristic, capacitance and tolerance. (Example: 2482-012-X5U0-272M)

For additional EIA Codes and Tolerances, please see page 25.

For additional product lines manufactured by TUSONIX, please refer to the back cover of this Catalog.

The products listed in this catalog are only a few of the thousands of variations that TUSONIX produces. For custom component design, please contact the factory direct.



Solder Mount Feed-Thru Capacitors

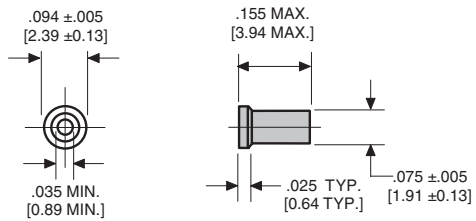

STYLE 1

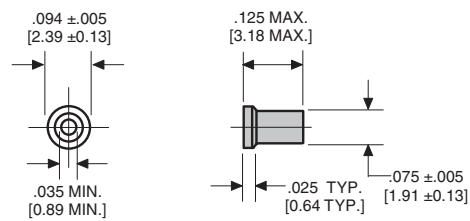

STYLE 2

inches
[mm]



STYLE 3

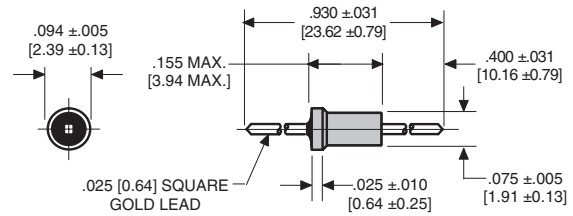

STYLE 4

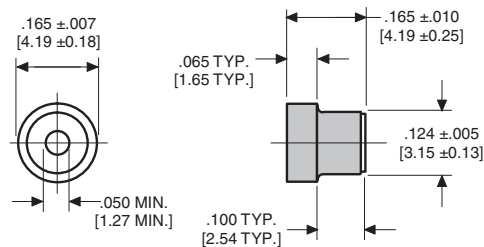

STYLE 5

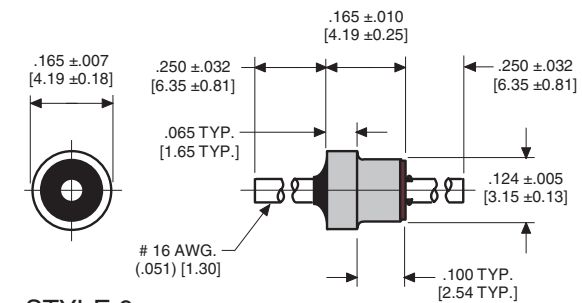

STYLE 6



STYLE 7



STYLE 8



STYLE 9



STYLE 10

Solder Mount Feed-Thru Capacitors



STYLE 11



STYLE 12



STYLE 13

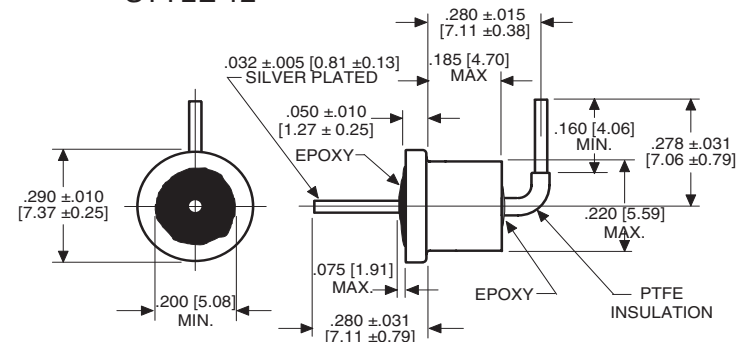

STYLE 14

Series Number	Temperature Range	WVDC	MAX. CAP. Nominal (pF)
2404	Z5, Y5, X5	500	7000
	X7	250	7000
2482	Z5, Y5, X5	300	4000
	X7	150	4000
2450	Z5, Y5, X5	500	1800
	X7	250	1800
2461	Z5, Y5, X5	200	1000
	X7	100	1000
2463	Z5, Y5, X5	200	2000
	X7	100	2000
2470	Z5, Y5, X5	250AC	2000



STYLE 15

Drawings not to scale.

Please see temperature Characteristics and EIA Codes on page 25.

●UL Recognized to UL standard 1283; UL File No. E201344

TUSONIX Part Number	Style	Notes	Circuit	Working Voltage (dc)		Capacitance (pF)	Capacitance Tolerance	Current (A)	Typical No-Load Insertion Loss (dB) at 25°C per MIL-Std-220				
				85°C	125°C				1MHz	10MHz	100MHz	1GHz	10GHz
C Configuration													
2463-001-X5S0-471M	2	--	C	200	--	470	±20%	--	--	12	27	27	
2463-002-X5S0-471M	3	--	C	200	--	470	±20%	10	--	12	27	27	
2463-003-X5U0-471P	4	--	C	200	--	470	+100-0%	10	--	12	27	27	
2461-000-X7V0-102P	5	--	C	--	100	1000	+100-0%	--	--	3	20	35	40
2461-001-X7V0-102AA	6	--	C	--	100	1000	GMV	20	--	3	20	35	40
2461-002-X7V0-102M	7	--	C	--	100	1000	±20%	20	--	3	20	35	40
2463-000-X7U0-152P	1	--	C	--	100	1500	+100-0%	--	--	5	22	35	40
2463-002-X5U0-152P	3	--	C	200	--	1500	+100-0%	10	--	5	22	35	40
2463-003-X5U0-152P	4	--	C	200	--	1500	+100-0%	10	--	5	22	35	40
2482-001-X5U0-471M	9	--	C	300	--	470	±20%	20	--	12	27	27	
2482-012-X5U0-102M	8	--	C	300	--	1000	±20%	--	--	3	20	35	40
2482-001-X5U0-102M	9	--	C	300	--	1000	±20%	20	--	3	20	35	40
2450-001-X5R0-101K	13	--	C	500	--	100	±10%	20	--	3	20	28	
2450-001-X5R0-471M	13	--	C	500	--	470	±20%	20	--	12	27	27	
2404-000-X7R0-471M	11	--	C	--	250	470	±20%	20	--	12	27	27	
2450-001-X5U0-102P	13	--	C	500	--	1000	+100-0%	20	--	3	20	35	40
2404-000-X5U0-102P	11	--	C	500	--	1000	+100-0%	20	--	3	20	35	40
2404-014-X5U0-102P	12	--	C	500	--	1000	+100-0%	--	--	3	20	35	40
2404-014-X5W0-502M	12	--	C	500	--	5000	±20%	--	--	15	30	45	50
2404-000-X5W0-502Z	11	--	C	500	--	5000	+80-20%	20	--	15	30	45	50
2404-007-X5W0-502Z	10	--	C	500	--	5000	+80-20%	15	--	15	30	45	50
2470-500●	14	--	C	250AC	--	1000	+100-0%	10	--	3	20	35	40
2470-501●	15	--	C	250AC	--	1000	+100-0%	10	--	3	20	35	40

The products listed in this catalog are only a few of the thousands of variations that TUSONIX produces. For custom component design, please contact the factory direct.



Solder Mount C Filters

4300 Series Miniature EMI Filter MICROWAVE APPLICATIONS:



STYLE 1



STYLE 2



STYLE 3

- Oscillators
- Attenuators
- Low Noise Amplifiers
- Microwave Filters

inches
[mm]

TUSONIX Part Number	Style	Circuit	Working Voltage (dc)		Capacitance (pF)	Capacitance Tolerance	Current (A)	Minimum No-Load Insertion Loss (dB) at 25°C per MIL-Std-220					Color Code
			85°C	125°C				1MHz	10MHz	100MHz	1GHz	10GHz	
Epoxy Sealed Top (flange)/ Glass Sealed Bottom													
4300-005	1	C	70	50	10,000	GMV	5	4	21	35	50	60	BLACK
4300-055	1	C	70	50	10,000	±20%	5	4	21	35	50	60	BLK-GOLD
4300-006	1	C	70	50	15,000	GMV	5	7	20	35	55	60	ORANGE
4300-013	1	C	70	50	27,000	GMV	5	10	28	42	65	65	RED-RED
4300-014	1	C	50	50	50,000	GMV	5	15	35	45	70	--	BLU-BLU
4300-003	1	C	150	100	2700	GMV	5	--	10	25	40	50	RED
4300-053	1	C	150	100	2700	±20%	5	--	10	25	40	50	RED-GOLD
4300-004	1	C	150	100	5000	GMV	5	--	15	30	45	55	YELLOW
4300-054	1	C	150	100	5000	±20%	5	--	15	30	45	55	YEL-GOLD
4300-680	1	C	300	200	5	MAX	5	--	--	--	--	--	BLK-BLK
4300-008	1	C	300	200	10	GMV	5	--	--	--	5	20	VIOLET
4300-009	1	C	300	200	25	GMV	5	--	--	--	10	25	BLUE
4300-000	1	C	300	200	100	GMV	5	--	--	3	20	28	GREEN
4300-050	1	C	300	200	100	±20%	5	--	--	3	20	28	GRN-GOLD
4300-001	1	C	300	200	500	GMV	5	--	--	15	35	40	BROWN
4300-051	1	C	300	200	500	±20%	5	--	--	15	35	40	BRWN-GOLD
4300-007	1	C	300	200	1000	GMV	5	--	5	20	35	45	GRAY
4300-002	1	C	300	200	1200	GMV	5	--	5	20	35	45	WHITE
4300-052	1	C	300	200	1200	±20%	5	--	5	20	35	45	WHT-GOLD

Drawings not to scale.

Solder Mount C Filters

TUSONIX 4300 Series Miniature EMI Filters

These filters are ideal for applications where small size and high performance are critical. These C configured filters can be glass sealed on either one of the ends for optimal sealing between system compartments or components.

The gold plating on the leads offers excellent conductivity and connective ability using common gold bonding methods. The small package and large range of electrical characteristics of the 4300 Series make it an effective solution for a variety of microwave applications.



TUSONIX Part Number	Style	Circuit	Working Voltage (dc)		Capacitance (pF)	Capacitance Tolerance	Current (A)	Minimum No-Load Insertion Loss (dB) at 25°C per MIL-Std-220					Color Code
			85°C	125°C				1MHz	10MHz	100MHz	1GHz	10GHz	
Glass Sealed Top (flange)/ Epoxy Sealed Bottom													
4300-025	2	C	70	50	10,000	GMV	5	4	21	35	50	60	BLACK
4300-065	2	C	70	50	10,000	±20%	5	4	21	35	50	60	BLK-GOLD
4300-026	2	C	70	50	15,000	GMV	5	7	20	35	55	60	ORANGE
4300-031	2	C	70	50	27,000	GMV	5	10	28	42	65	65	RED-RED
4300-034	2	C	50	50	50,000	GMV	5	15	35	45	70	--	BLU-BLU
4300-023	2	C	150	100	2700	GMV	5	--	10	25	40	50	RED
4300-063	2	C	150	100	2700	±20%	5	--	10	25	40	50	RED-GOLD
4300-024	2	C	150	100	5000	GMV	5	--	15	30	45	55	YELLOW
4300-064	2	C	150	100	5000	±20%	5	--	15	30	45	55	YEL-GOLD
4300-681	2	C	300	200	5	MAX	5	--	--	--	--	--	BLK-BLK
4300-028	2	C	300	200	10	GMV	5	--	--	--	5	20	VIOLET
4300-029	2	C	300	200	25	GMV	5	--	--	--	10	25	BLUE
4300-020	2	C	300	200	100	GMV	5	--	--	3	20	28	GREEN
4300-060	2	C	300	200	100	±20%	5	--	--	3	20	28	GRN-GOLD
4300-021	2	C	300	200	500	GMV	5	--	--	15	35	40	BROWN
4300-061	2	C	300	200	500	±20%	5	--	--	15	35	40	BRWN-GOLD
4300-027	2	C	300	200	1000	GMV	5	--	5	20	35	45	GRAY
4300-022	2	C	300	200	1200	GMV	5	--	5	20	35	45	WHITE
4300-062	2	C	300	200	1200	±20%	5	--	5	20	35	45	WHT-GOLD
Epoxy Sealed Top (flange)/ Epoxy Sealed Bottom													
4302-005	3	C	70	50	10,000	GMV	10	4	21	35	50	60	BLACK
4302-006	3	C	70	50	15,000	GMV	10	7	20	35	55	60	ORANGE
4302-013	3	C	70	50	27,000	GMV	10	10	28	42	65	65	RED-RED
4302-014	3	C	50	50	50,000	GMV	10	15	35	45	70	--	BLU-BLU
4302-003	3	C	150	100	2700	GMV	10	--	10	25	40	50	RED
4302-004	3	C	150	100	5000	GMV	10	--	15	30	45	55	YELLOW
4302-680	3	C	300	200	5	MAX	10	--	--	--	--	--	BLK-BLK
4302-008	3	C	300	200	10	GMV	10	--	--	--	5	20	VIOLET
4302-009	3	C	300	200	25	GMV	10	--	--	--	10	25	BLUE
4302-000	3	C	300	200	100	GMV	10	--	--	3	20	28	GREEN
4302-001	3	C	300	200	500	GMV	10	--	--	15	35	40	BROWN
4302-007	3	C	300	200	1000	GMV	10	--	5	20	35	45	GRAY
4302-002	3	C	300	200	1200	GMV	10	--	5	20	35	45	WHITE

The products listed in this catalog are only a few of the thousands of variations that TUSONIX produces. For custom component design, please contact the factory direct.



Solder Mount C Filters

4305 Series - Extra Mini EMI Filters

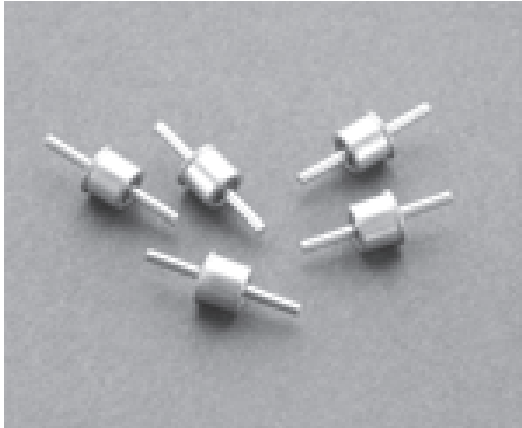

TUSONIX Part Number	Circuit	Working Voltage (dc)		Capacitance (pF)	Capacitance Tolerance	Current (A)	Minimum No-Load Insertion Loss (dB) at 25°C per MIL-Std-220					Color Code
		85°C	125°C				1MHz	10MHz	100MHz	1GHz	10GHz	
Epoxy Sealed Top (flange)/ Glass Sealed Bottom												
4305-000	C	300	200	50	+100-0%	5	--	--	--	10	25	BRWN-BROWN
4305-001	C	300	200	100	+100-0%	5	--	--	3	20	28	GREEN
4305-002	C	300	200	500	+100-0%	5	--	--	15	35	40	BROWN
4305-003	C	150	100	2700	+100-0%	5	--	10	25	40	50	RED
4305-004	C	150	100	5000	+100-0%	5	--	15	30	45	55	YELLOW
4305-005	C	300	200	10	+100-0%	5	--	--	--	5	20	VIOLET
4305-006	C	300	200	25	+100-0%	5	--	--	--	10	25	BLUE
4305-007	C	300	200	250	+100-0%	5	--	--	5	22	30	YEL-YELLOW
4305-008	C	300	200	1000	+100-0%	5	--	5	20	35	45	GRAY
4305-009	C	300	200	1500	+100-0%	5	--	5	22	35	45	GREEN-GREEN
4305-010	C	50	50	10,000	+100-0%	5	4	21	35	50	60	BLACK
4305-011	C	70	50	27,000	+100-0%	5	10	28	42	65	65	RED-RED
4305-012	C	300	200	5	+100-0%	5	--	--	--	--	5	BLUE-BLUE
4305-680	C	300	200	5	MAX	5	--	--	--	--	--	BLACK-BLACK



Tusonix Press-In Ceramic EMI filters suppress unwanted EMI and allow a fast, mechanical bonding that is free from soldering. And, by offering an excellent alternative to the traditional soldering installation, these finely designed, knurled filters significantly reduce assembly costs.

These EMI filters cover a variety of voltage, attenuation and capacitance ranges in a press-in mounting style.

Product installation recommendations (X-2656/9) are provided with parts to prevent damage to the component during installation.



Installation tool

Tool Part No.	Item No.	Filter Type
4300-314	1	4304

(Ordering Example for 4304 filter tool: 4300-314-1)

Installation Tool: Ordering Information to right.

TUSONIX Part Number	Circuit	Working Voltage (dc)		Capacitance (pF)	Capacitance Tolerance	Current (A)	Minimum No-Load Insertion Loss (dB) at 25°C per MIL-Std-220					Color Code
		85°C	125°C				1MHz	10MHz	100MHz	1GHz	10GHz	
Epoxy Sealed Top (flange)/ Glass Sealed Bottom												
4304-000	C	300	200	10	+100-0%	5	--	--	--	5	20	VIOLET
4304-001	C	300	200	25	+100-0%	5	--	--	--	10	25	BLUE
4304-002	C	300	200	500	+100-0%	5	--	--	15	35	40	BROWN
4304-003	C	300	200	100	+100-0%	5	--	--	3	20	28	GREEN
4304-004	C	300	200	1000	+100-0%	5	--	5	20	35	45	GRAY
4304-005	C	300	200	1200	+100-0%	5	--	5	20	35	45	WHITE
4304-006	C	150	100	2700	+100-0%	5	--	10	25	40	50	RED
4304-007	C	150	100	5000	+100-0%	5	--	15	30	45	55	YELLOW
4304-008	C	50	50	10000	+100-0%	5	4	21	35	50	60	BLACK
4304-009	C	70	50	15000	+100-0%	5	7	20	35	55	60	ORANGE
4304-010	C	70	50	27000	+100-0%	5	10	28	42	65	65	RED-RED
4304-011	C	50	50	50000	+100-0%	5	15	35	45	70	--	BLUE-BLUE
4304-681	C	300	200	5	MAX	5	--	--	--	--	--	BLACK-BLACK

The products listed in this catalog are only a few of the thousands of variations that TUSONIX produces. For custom component design, please contact the factory direct.



No Solder/Press-In EMI Filters

4306 Series - C Filters



Installation tool

Installation tool

Tool Part No.	Item No.	Filter Type
4300-314	2	4306

(Ordering Example for 4306 filter tool: 4300-314-2)



Style 1



Style 2

4306 Series - C Filters

No Solder/Press-In C Filters

TUSONIX's Press-In EMI filters are excellent for a variety of microwave and RF applications that include:

- attenuators
- oscillators
- synthesizers
- combiners

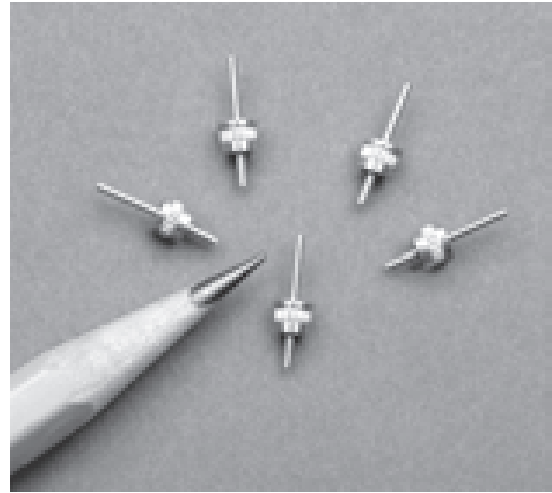

TUSONIX Part Number	Style	Circuit	Working Voltage (dc)		Capacitance (pF)	Capacitance Tolerance	Current (A)	Minimum No-Load Insertion Loss (dB) at 25°C per MIL-Std-220					Color Code
			85°C	125°C				1MHz	10MHz	100MHz	1GHz	10GHz	
Epoxy Sealed Top (flange)/ Glass Sealed Bottom													
4306-010	1	C	50	50	10000	+100-0%	5	4	21	35	50	60	BLACK
4306-011	1	C	70	50	27000	+100-0%	5	10	28	42	65	65	RED-RED
4306-030	1	C	150	100	2700	+100-0%	5	--	10	25	40	50	RED
4306-004	1	C	150	100	5000	+100-0%	5	--	15	30	45	55	YELLOW
4306-012	1	C	300	200	5	+100-0%	5	--	--	--	--	5	BLUE-BLUE
4306-680	1	C	300	200	5	MAX	5	--	--	--	--	--	BLACK-BLACK
4306-028	1	C	300	200	10	+100-0%	5	--	--	--	5	20	VIOLET
4306-006	1	C	300	200	25	+100-0%	5	--	--	--	10	25	BLUE
4306-005	1	C	300	200	50	+100-0%	5	--	--	--	10	25	BROWN-BROWN
4306-029	1	C	300	200	100	+100-0%	5	--	--	3	20	28	GREEN
4306-007	1	C	300	200	250	+100-0%	5	--	--	5	22	30	YELLOW-YELLOW
4306-003	1	C	300	200	500	+100-0%	5	--	--	15	35	40	BROWN
4306-008	1	C	300	200	1000	+100-0%	5	--	5	20	35	45	GRAY
4306-009	1	C	300	200	1500	+100-0%	5	--	5	22	35	45	GREEN-GREEN
Glass Sealed Top (flange)/ Epoxy Sealed Bottom													
4306-023	2	C	50	50	10000	+100-0%	5	4	21	35	50	60	BLACK
4306-024	2	C	70	50	27000	+100-0%	5	10	28	42	65	65	RED-RED
4306-015	2	C	150	100	2700	+100-0%	5	--	10	25	40	50	RED
4306-017	2	C	150	100	5000	+100-0%	5	--	15	30	45	55	YELLOW
4306-025	2	C	300	200	5	+100-0%	5	--	--	--	--	5	BLUE-BLUE
4306-681	2	C	300	200	5	MAX	5	--	--	--	--	--	BLACK-BLACK
4306-013	2	C	300	200	10	+100-0%	5	--	--	--	5	20	VIOLET
4306-019	2	C	300	200	25	+100-0%	5	--	--	--	10	25	BLUE
4306-018	2	C	300	200	50	+100-0%	5	--	--	--	10	25	BROWN-BROWN
4306-014	2	C	300	200	100	+100-0%	5	--	--	3	20	28	GREEN
4306-020	2	C	300	200	250	+100-0%	5	--	--	5	22	30	YELLOW-YELLOW
4306-016	2	C	300	200	500	+100-0%	5	--	--	15	35	40	BROWN
4306-021	2	C	300	200	1000	+100-0%	5	--	5	20	35	45	GRAY
4306-022	2	C	300	200	1500	+100-0%	5	--	5	22	35	45	GREEN-GREEN

The products listed in this catalog are only a few of the thousands of variations that TUSONIX produces. For custom component design, please contact the factory direct.



Solder Mount Pi Filters



STYLE 1



STYLE 2



STYLE 3



STYLE 4

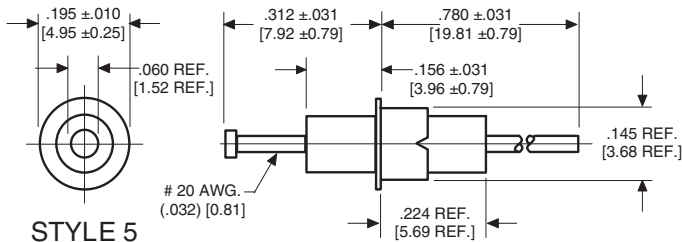

STYLE 5

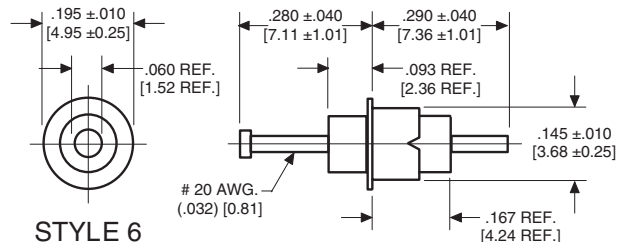

STYLE 6

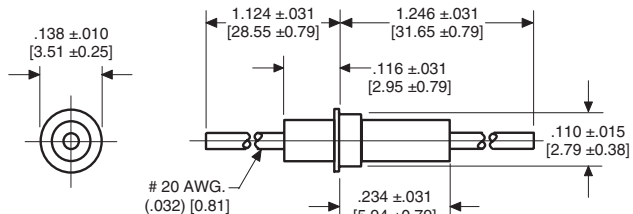

STYLE 7



STYLE 8



STYLE 9



STYLE 10



STYLE 11



STYLE 12

Drawings not to scale.

Solder Mount Pi Filters



STYLE 13 THROUGH 19

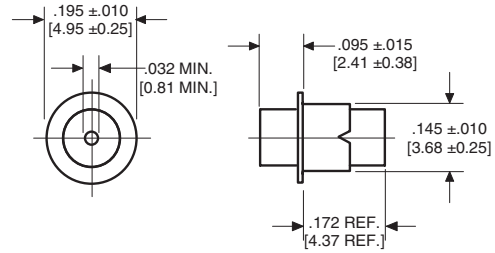

STYLE 20

inches
[mm]

DIMENSIONS FOR STYLES 13 THROUGH 19

Style Number	MIL-PRF-15733	DIM. A	DIM. B	DIM. C	DIM. D	DIM. E	DIM. F	DIM. G
13	/62-0003	.272 ± .025 [6.91 ± 0.64]	.438 ± .062 [11.13 ± 1.57]	.156 ± .015 [3.96 ± 0.38]	.312 ± .031 [7.92 ± 0.79]	.145 ± .015 [3.68 ± 0.38]	----	.190 ± .015 [4.83 ± 0.38]
14	/62-0004	.151 ± .031 [3.84 ± 0.79]	.780 ± .031 [19.81 ± 0.79]	.093 ± .031 [2.36 ± 0.79]	.273 ± .031 [6.93 ± 0.79]	.145 ± .015 [3.68 ± 0.38]	----	.196 ± .007 [4.98 ± 0.18]
15	/51-0002	.226 ± .022 [5.74 ± 0.56]	.780 ± .031 [19.81 ± 0.79]	.164 ± .022 [4.16 ± 0.56]	.312 ± .031 [7.92 ± 0.79]	.145 ± .015 [3.68 ± 0.38]	----	.203 ± .015 [5.16 ± 0.38]
16	/33-0001 /33-0002 ♦	.170 ± .027 [4.32 ± 0.69]	.780 ± .031 [19.81 ± 0.79]	.093 ± .015 [2.36 ± 0.38]	.288 ± .015 [7.32 ± 0.38]	----	.125 MAX [3.18 MAX]	.190 ± .015 [4.83 ± 0.38]
17	/62-0001	.250 ± .031 [6.35 ± 0.79]	.406 ± .031 [10.31 ± 0.79]	.156 ± .031 [3.96 ± 0.79]	.312 ± .031 [7.92 ± 0.79]	.145 ± .015 [3.68 ± 0.38]	.125 ± .015 [3.18 ± 0.38]	.190 ± .015 [4.83 ± 0.38]
18	/62-0002 ♦	.231 ± .046 [5.87 ± 1.17]	1.231 ± .077 [31.27 ± 1.96]	.109 ± .031 [2.77 ± 0.79]	1.109 ± .062 [28.17 ± 1.57]	.110 ± .015 [2.79 ± 0.38]	----	.143 ± .010 [3.63 ± 0.25]
19	/51-0001	.250 ± .031 [6.35 ± 0.79]	.406 ± .031 [10.31 ± 0.79]	.156 ± .031 [3.96 ± 0.79]	.312 ± .031 [7.92 ± 0.79]	.142 ± .007 [3.61 ± 0.18]	.122 ± .017 [3.10 ± 0.43]	.195 ± .010 [4.95 ± 0.25]

Notes:



Straight Lead

TUSONIX Part Number	MIL-PRF-15733 Number	Style	Notes	Circuit	Working Voltage (dc)		Capacitance (pF)	Capacitance Tolerance	Current (A)	Minimum No-Load Insertion Loss (dB) at 25°C per MIL-Std-220				
					85°C	125°C				1MHz	10MHz	100MHz	1GHz	10GHz
Pi Configuration														
4100-003	--	1	--	Pi	125	50	3000	GMV	15	--	7	50	65	60
4101-505	/62-0003	13	--	Pi	--	70	1500	GMV	10	--	--	50	65	65
4151-000	--	3	--	Pi	100	70	12,000	GMV	10	--	25	70	65	65
4151-500	/62-0004	14	--	Pi	--	70	12,000	GMV	10	--	22	70	--	65
4151-001	--	5	--	Pi	100	70	22,000	GMV	10	--	35	70	70	70
4151-501	/51-0002	15	--	Pi	--	70	22,000	GMV	10	--	25	70	70	70
4151-003	--	12	--	Pi	100	70	60,000	GMV	10	--	60	75	75	75
4100-000	--	7	--	Pi	250	125	1500	GMV	10	--	6	45	60	60
4101-000	--	20	--	Pi	250	125	1750	GMV	10	--	5	35	50	50
4101-002	--	2	--	Pi	250	125	1750	GMV	10	--	5	50	60	60
4101-003	--	4	--	Pi	250	125	1750	GMV	10	--	5	50	60	60
4101-004	--	6	--	Pi	250	125	1750	GMV	10	--	5	50	60	60
4101-502	/33-0001	16	--	Pi	--	125dc 90ac	1750	GMV	10	--	--	50	60	60
4101-503	/33-0002	16	♦	Pi	--	125dc 90ac	1750	GMV	10	--	--	50	60	60
4101-500	/66-0001	8	--	Pi	--	125	1750	GMV	10	--	5	35	50	50
4100-056	--	9	--	Pi	250ac	200dc	1000	±20%	10	--	3	20	55	--
4100-002	--	1	--	Pi	350	200	1500	GMV	15	--	5	25	60	60
4101-001	--	17	--	Pi	350	200	1500	GMV	10	--	3	45	70	70
4101-501	/62-0001	17	--	Pi	--	200dc 140ac	1500	GMV	10	--	3	45	70	70
4100-500	/62-0002	18	♦	Pi	--	200	1500	GMV	10	--	5	45	70	--
4100-057	--	9	--	Pi	250ac	200dc	1500	GMV	10	--	5	45	70	--
4102-000	--	10	--	Pi	350	200	3000	GMV	10	--	8	55	65	65
4100-053	--	9	--	Pi	250ac	200dc	5000	GMV	10	--	18	60	70	--
4101-504	/51-0001	19	--	Pi	200dc 200ac	--	5500	GMV	10	--	15	55	70	70
4106-000	--	11	--	Pi	500dc 350ac	500	3000	GMV	25	--	--	50	50	50
4106-001	--	11	--	Pi	1000	500	4500	GMV	25	--	8	50	70	70



Компания «ЭлектроПласт» предлагает заключение долгосрочных отношений при поставках импортных электронных компонентов на взаимовыгодных условиях!

Наши преимущества:

- Оперативные поставки широкого спектра электронных компонентов отечественного и импортного производства напрямую от производителей и с крупнейших мировых складов;
- Поставка более 17-ти миллионов наименований электронных компонентов;
- Поставка сложных, дефицитных, либо снятых с производства позиций;
- Оперативные сроки поставки под заказ (от 5 рабочих дней);
- Экспресс доставка в любую точку России;
- Техническая поддержка проекта, помощь в подборе аналогов, поставка прототипов;
- Система менеджмента качества сертифицирована по Международному стандарту ISO 9001;
- Лицензия ФСБ на осуществление работ с использованием сведений, составляющих государственную тайну;
- Поставка специализированных компонентов (Xilinx, Altera, Analog Devices, Intersil, Interpoint, Microsemi, Aeroflex, Peregrine, Syfer, Eurofarad, Texas Instrument, Miteq, Cobham, E2V, MA-COM, Hittite, Mini-Circuits, General Dynamics и др.);

Помимо этого, одним из направлений компании «ЭлектроПласт» является направление «Источники питания». Мы предлагаем Вам помощь Конструкторского отдела:

- Подбор оптимального решения, техническое обоснование при выборе компонента;
- Подбор аналогов;
- Консультации по применению компонента;
- Поставка образцов и прототипов;
- Техническая поддержка проекта;
- Защита от снятия компонента с производства.



Как с нами связаться

Телефон: 8 (812) 309 58 32 (многоканальный)

Факс: 8 (812) 320-02-42

Электронная почта: org@eplast1.ru

Адрес: 198099, г. Санкт-Петербург, ул. Калинина, дом 2, корпус 4, литера А.