

Description

The F1456 is a High Gain / High Linearity 2100 MHz to 2950 MHz TX Digital Variable Gain Amplifier used in transmitter applications.

The F1456 TX DVGA provides 32.1 dB maximum gain with +38 dBm OIP3 and 3.9 dB noise figure. Up to 31.5 dB gain control is achieved using the combination of a digital step attenuator (DSA) and a K_{LIN}^{TM} RF Digital Gain Amplifier. This device uses a single 5 V supply and 215 mA of I_{CC} .

This device is packaged in a 6 mm x 6 mm, 28-pin QFN with 50 Ω single-ended RF input and RF output impedances for ease of integration into the signal-path.

Competitive Advantage

In typical Base Stations, RF VGAs are used in the TX traffic paths to drive the transmit power amplifier. The F1456 TX DVGA offers very high reliability due to its construction from a monolithic silicon die in a QFN package. The F1456 is configured to provide an optimum balance of noise and linearity performance consisting of a K_{LIN}^{TM} RF amplifier, digital step attenuator (DSA) and a PA driver amplifier. The K_{LIN}^{TM} amplifier maintains the OIP3 and output P1dB performance over an extended attenuation range when compared to competitive devices.

Typical Applications

- Multi-mode, Multi-carrier Transmitters
- WiMAX and LTE Base Stations
- UMTS/WCDMA 3G Base Stations
- PHS/PAS Base Stations
- Public Safety Infrastructure

Features

- Broadband 2100 MHz to 2950 MHz
- 32.1 dB max gain
- 3.9 dB NF @ max gain (2650 MHz)
- 31.5 dB total gain control range, 0.5 dB step
- < 2 dB overshoot between gain transitions
- Maintains flat +21.5 dBm OP1dB for more than 13 dB gain adjustment range
- Maintains flat +38 dBm OIP3 for more than 15 dB gain adjustment range
- SPI interface for DSA control
- Single 5 V supply voltage
- $I_{CC} = 215$ mA
- Up to +105 °C T_{CASE} operating temperature
- 50 Ω input and output impedance
- Standby mode for power savings
- Pin compatible 700 MHz and 2100 MHz versions
- 6 mm x 6 mm, 28-pin QFN package

Block Diagram

Figure 1. Block Diagram

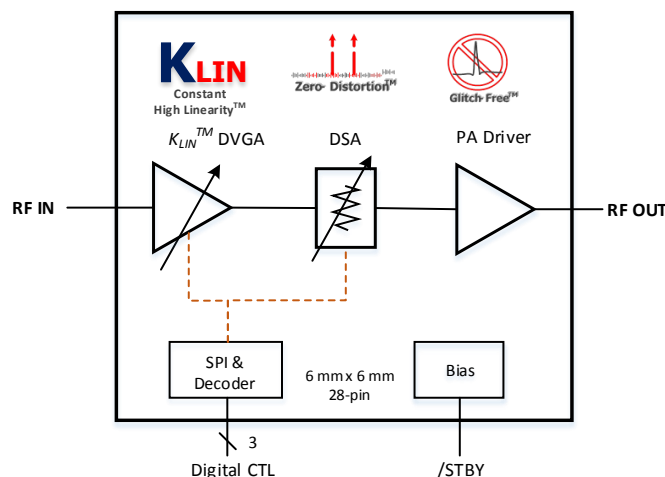

Pin Assignments

Figure 2. Pin Assignments for 6 mm x 6 mm x 0.9 mm QFN Package – Top View

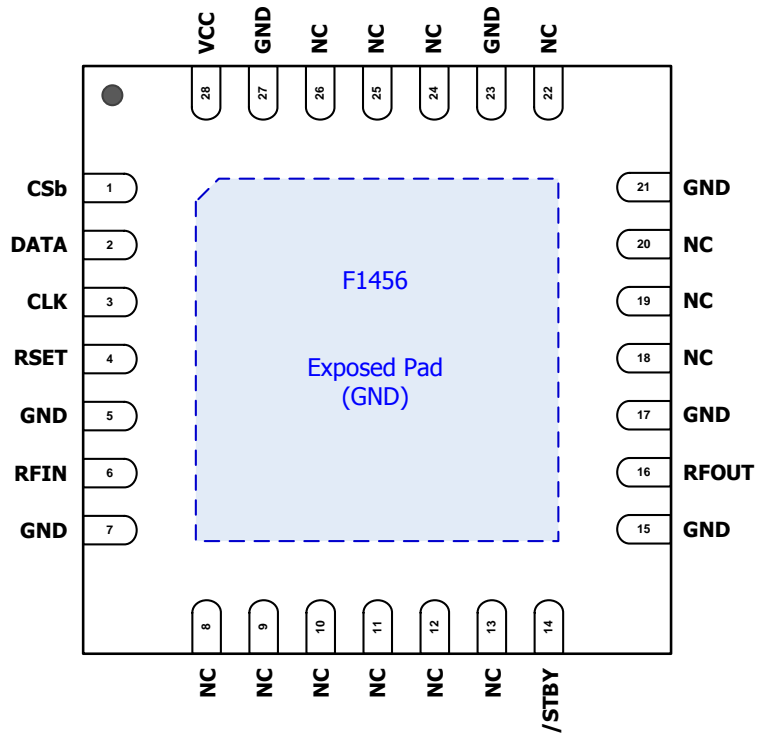

Pin Descriptions

Table 1. Pin Descriptions

Number	Name	Description
1	CSb	Chip Select Input: 1.8 V or 3.3 V logic compatible.
2	DATA	Data Input: 1.8 V or 3.3 V logic compatible.
3	CLK	Clock Input: 1.8 V or 3.3 V logic compatible.
4 ^[a]	RSET	Connect 2.2 k Ω external resistor to GND to set amplifier bias.
5, 7, 15, 17, 21, 23, 27	GND	Pins internally tied to exposed paddle. Connect to ground on PCB.
6	RFIN	RF input internally matched to 50 Ω . Must use external DC block.
8, 9, 10, 11, 12, 13, 18, 19, 20, 22, 24, 25, 26	NC	No internal connection. These pins can be left unconnected, voltage applied, or connected to ground (recommended).
14	/STBY	Standby pin. Device will be placed in standby mode when pin 14 is set to a logic low or when pin 14 is left floating (pulled low via internal high impedance to GND). In standby mode, SPI circuitry is still active. With a logic high applied to pin 14 the part is set to full operation mode.
16	RFOUT	RF output internally matched to 50 Ω . Must use external DC block.
28	VCC	5 V Power Supply. Connect to V_{cc} and use bypass capacitors as close to the pin as possible.
	— EP	Exposed Pad. Internally connected to GND. Solder this exposed pad to a PCB pad that uses multiple ground vias to provide heat transfer out of the device into the PCB ground planes. These multiple ground vias are also required to achieve the noted RF performance.

- a. External resistor on pin 4 used to optimize the overall device for DC current and linearity performance across the entire frequency band.

Absolute Maximum Ratings

Stresses above those listed below may cause permanent damage to the device. Functional operation of the device at these or any other conditions above those indicated in the operational section of this specification is not implied. Exposure to absolute maximum rating conditions for extended periods may affect device reliability.

Table 2. Absolute Maximum Ratings

Parameter	Symbol	Minimum	Maximum	Units
V_{CC} to GND	V_{CC}	-0.5	5.5	V
DATA, CSb, CLK, /STBY	V_{Cntrl}	-0.5	V_{CC}	V
RSET	I_{RSET}		+1.5	mA
RFIN externally applied DC voltage	V_{RFIN}	+1.4	+3.6	V
RFOUT externally applied DC voltage	V_{RFOUT}	$V_{CC} - 0.15$	$V_{CC} + 0.15$	V
RF Input Power (RFIN) applied for 24 hours max. [a]	P_{max_in}		+12	dBm
RF Output Power (RFOUT) present for 24 hours maximum [a]	P_{max_out}		+26	dBm
Continuous Power Dissipation	P_{diss}		1.75	W
Junction Temperature	T_j		150	°C
Storage Temperature Range	T_{st}	-65	150	°C
Lead Temperature (soldering, 10s)			260	°C
ElectroStatic Discharge – HBM (JEDEC/ESDA JS-001-2012)			2000 (Class 2)	V
ElectroStatic Discharge – CDM (JEDEC 22-C101F)			1000 (Class C3)	V

- a. Exposure to these maximum RF levels can result in significantly higher I_{CC} current draw due to overdriving the amplifier stages.

Recommended Operating Conditions

Table 3. Recommended Operating Conditions

Parameter	Symbol	Condition	Minimum	Typical	Maximum	Units
Power Supply Voltage	V_{CC}		4.75		5.25	V
Operating Temperature Range	T_{CASE}	Exposed Paddle	-40		+105	°C
RF Frequency Range ^(a)	F_{RF}	High Linearity Bandwidth	2100		2700	MHz
		Extended band for DPD	2700		2950	
Maximum Operating Average RF Output Power		$Z_S = Z_L = 50 \Omega$			14	dBm
RFIN Port Impedance	Z_{RFI}	Single Ended		50		Ω
RFOUT Port Impedance	Z_{RFO}	Single Ended		50		Ω

- a. Device linearity is optimized over the range from 2100 MHz to 2700 MHz. Gain flatness is optimized up to 2950 MHz to account for systems with extended DPD bandwidth requirements.

Electrical Characteristics - General

See Typical Application Circuit. Unless otherwise stated, specifications apply when operated as a TX VGA, $V_{CC} = +5.0\text{ V}$, $F_{RF} = 2.65\text{ GHz}$, $T_{CASE} = +25\text{ }^{\circ}\text{C}$, $/\text{STBY} = \text{High}$, $Z_S = Z_L = 50\ \Omega$, maximum gain setting. Evaluation Kit trace and connector losses are de-embedded.

Table 4. Electrical Characteristics

Parameter	Symbol	Condition	Minimum	Typical	Maximum	Units
Logic Input High Threshold	V_{IH}	JEDEC 1.8V or 3.3V logic	1.1 ^[a]		V_{CC}	V
Logic Input Low Threshold	V_{IL}	JEDEC 1.8V or 3.3V logic	-0.3		0.8	V
Logic Current	I_{IH}, I_{IL}	SPI	-1		+1	μA
	I_{STBY}	/STBY	-10		+10	
DC Current	I_{CC}			215	245	mA
Standby Current	I_{CC_STBY}	/STBY = Low		1	2	mA
Standby Switching Time	T_{STBY}	50% /STBY control to within 0.2 dB of the on state final gain value		250		ns
Gain Step	G_{STEP}	Least Significant Bit		0.5		dB
Maximum Attenuator Glitching	ATTN_G	Any state to state transition		2		dB
Maximum Step Error (DNL) [over voltage, temperature and attenuation states]	$\text{ERROR}_{\text{STEP}}$	$F_{RF} = 2.10\text{ GHz}$	-0.27 ^[b]		+0.24	dB
		$F_{RF} = 2.30\text{ GHz}$	-0.32		+0.26	
		$F_{RF} = 2.50\text{ GHz}$	-0.36		+0.29	
		$F_{RF} = 2.65\text{ GHz}$	-0.36		+0.31	
		$F_{RF} = 2.80\text{ GHz}$	-0.36		+0.33	
		$F_{RF} = 2.95\text{ GHz}$	-0.37		+0.36	
Maximum Absolute Error (INL)	$\text{ERROR}_{\text{ABS}}$			0.8		dB
Gain Settling Time ^[c]	G_{ST}	50% of CSb to 10% / 90% RF		200		ns
SPI ^[d]						
Serial Clock Speed	F_{CLOCK}				25	MHz
CSb to CLK Setup Time	T_{LS}		5			ns
CLK to Data Hold Time	T_{H}		5			ns
CSb Trigger to CLK Setup Time	T_{LC}		5			ns

- Items in min/max columns in **bold italics** are Guaranteed by Test.
- Items in min/max columns that are not bold/italics are Guaranteed by Design Characterization.
- Excludes SPI write time.
- SPI 3 wire bus (refer to serial Control Mode Timing diagram).

Electrical Characteristics - RF

See Typical Application Circuit. Unless otherwise stated, specifications apply when operated as a TX VGA, $V_{CC} = +5.0\text{ V}$, $F_{RF} = 2.65\text{ GHz}$, $T_{CASE} = +25\text{ }^{\circ}\text{C}$, /STBY = High, $Z_S = Z_L = 50\ \Omega$, maximum gain setting. Evaluation Kit trace and connector losses are de-embedded.

Table 5. Electrical Characteristics

Parameter	Symbol	Condition	Minimum	Typical	Maximum	Units
RF Input Return Loss	RL_{RFIN}			12		dB
RF Output Return Loss	RL_{RFOUT}			12		dB
Gain - Max Gain Setting	G_{MAX}		30.6	32.1	33.6	dB
Gain - Min Gain Setting	G_{MIN}	Max attenuation	-1.5	0	1.5	dB
Gain Flatness [c]	G_{FLAT}	$F_{RF} = 2100\text{ MHz to }2700\text{ MHz}$ any 400 MHz BW		0.5		dB
Noise Figure	NF	0 dB attenuation		3.9		dB
		10 dB attenuation		5.9		
		20 dB attenuation		10.9		
		29.5 dB attenuation		19.5		
		31.5 dB attenuation		21.5		
Output Third Order Intercept Point	OIP3	0 dB attenuation Pout = +7 dBm / tone 5 MHz tone separation		41.9		dBm
		6 dB attenuation Pin = -21 dBm / tone 5 MHz tone separation		45.4		
		10 dB attenuation Pin = -21 dBm / tone 5 MHz tone separation	35.5	43.6		
		20 dB attenuation Pin = -21 dBm / tone 5 MHz tone separation		36.1		
		29.5 dB attenuation Pin = -21 dBm / tone 5 MHz tone separation		27.4		
		31.5 dB attenuation Pin = -21 dBm / tone 5 MHz tone separation		25.7		
Output 1dB Compression Point	OP1dB	0 dB attenuation		21.9		dBm
		0 dB attenuation, $T_{CASE} = +105\text{ }^{\circ}\text{C}$		21.4		
		6 dB attenuation	20.9	21.9		

- Items in min/max columns in **bold italics** are Guaranteed by Test.
- Items in min/max columns that are not bold/italics are Guaranteed by Design Characterization.
- Includes a positive slope feature over the noted RF range to compensate for typical system roll-off.

Thermal Characteristics

Table 6. Package Thermal Characteristics

Parameter	Symbol	Value	Units
Junction to Ambient Thermal Resistance.	θ_{JA}	40	°C/W
Junction to Case Thermal Resistance. (Case is defined as the exposed paddle)	θ_{JC}	4	°C/W
Moisture Sensitivity Rating (Per J-STD-020)		MSL 1	

Typical Operating Conditions (TOC)

Unless otherwise stated the typical operating graphs were measured under the following conditions:

- $V_{CC} = 5.0\text{ V}$
- $Z_L = Z_S = 50\text{ Ohms}$ Single Ended
- $F_{RF} = 2.65\text{ GHz}$
- $T_{CASE} = +25\text{ °C}$
- /STBY = High
- 5 MHz Tone Spacing
- Gain setting = Maximum Gain
- All temperatures are referenced to the exposed paddle
- ACLR measurements used with a Basic LTE FDD Downlink 20 MHz TM1.2 Test signal
- EVM measurements used with a Basic LTE FDD Downlink 20 MHz TM3.1 Test signal
- Note TN1: Atten $\leq 4\text{ dB}$ Fixed Pout = 7 dBm per waveform or per tone, Atten $> 4\text{ dB}$ Fixed Pin = -21 dBm per waveform or per tone
- Note TN2: Atten $\leq 7\text{ dB}$ Fixed Pout = 10.5 dBm per waveform or per tone, Atten $> 7\text{ dB}$ Fixed Pin = -14.5 dBm per waveform or per tone
- Evaluation Kit traces and connector losses are de-embedded

Typical Performance Characteristics

Figure 3. Maximum Gain vs. Frequency over Temp and Voltage [Attn = 0.0 dB]

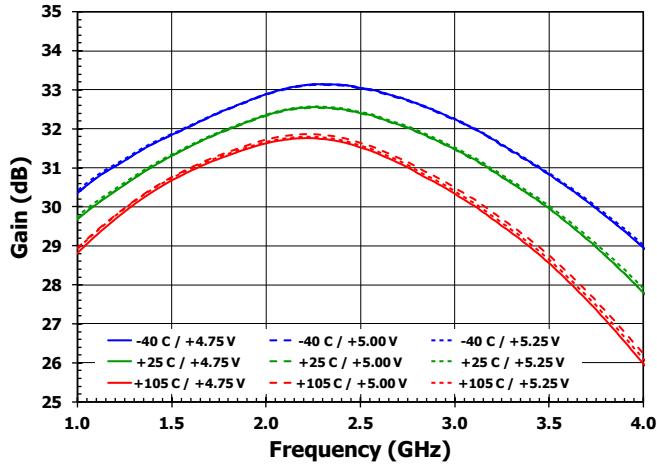

Figure 5. Input Return Loss vs. Frequency over Temp and Voltage [Attn = 0.0 dB]

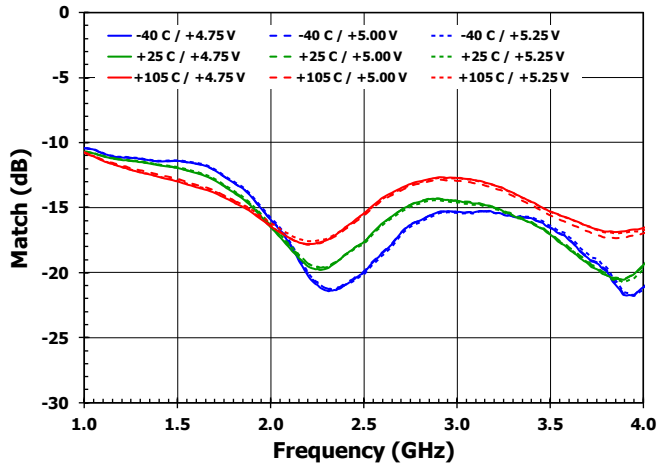

Figure 7. Stability vs. Frequency over Temperature and Voltage [Attn = 0.0 dB]

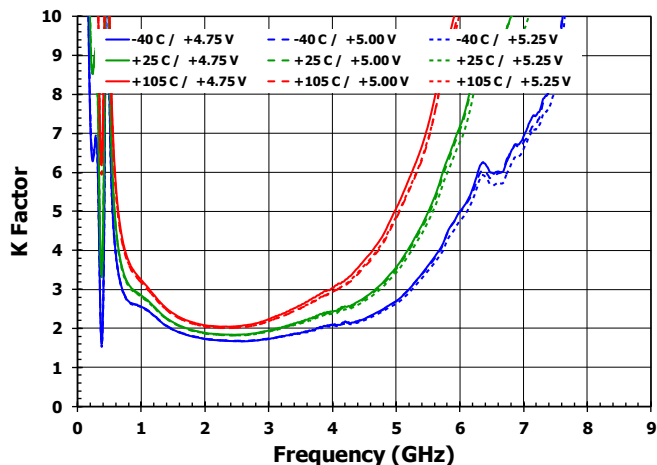

Figure 4. Reverse Isolation vs. Frequency over Temp and Voltage [Attn = 0.0 dB]

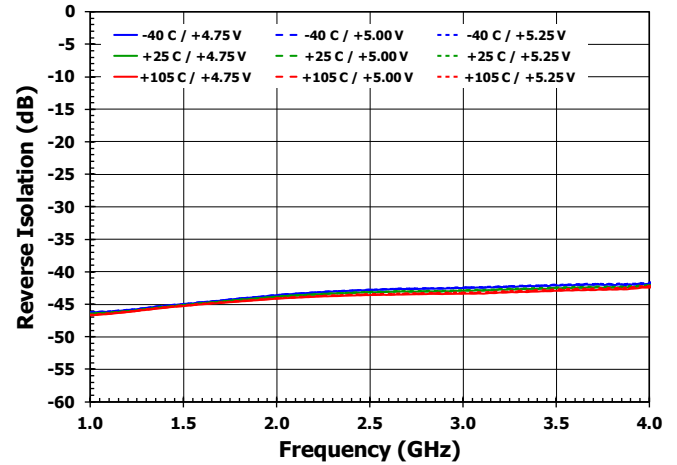

Figure 6. Output Return Loss vs. Frequency over Temp and Voltage [Attn = 0.0 dB]

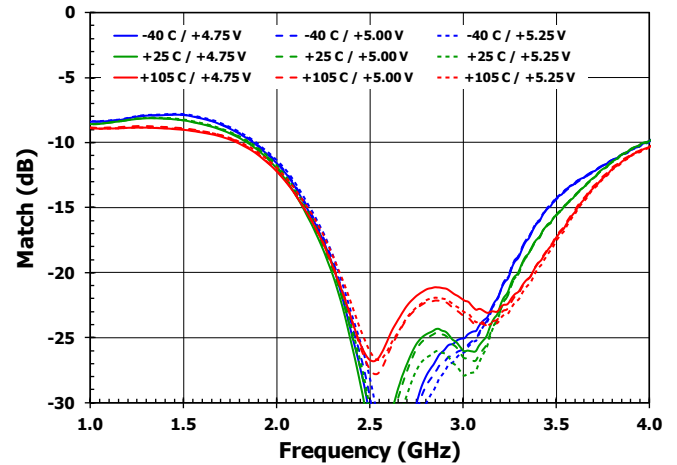
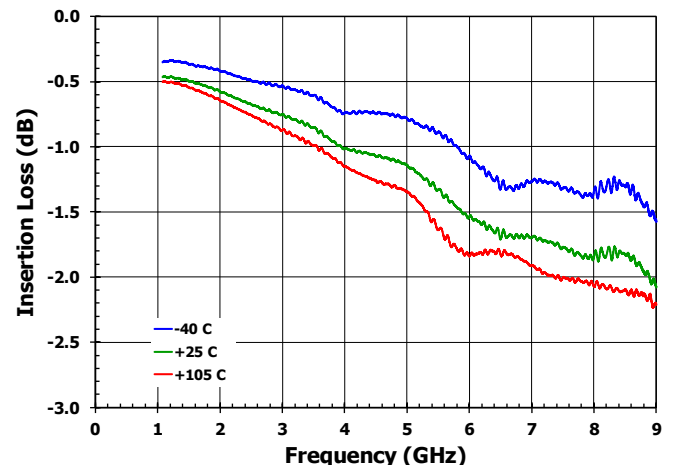

Figure 8. EvKit Insertion Loss vs. Frequency over Temperature



Typical Performance Characteristics

Figure 9. Gain vs. Frequency [+25 °C, All States]

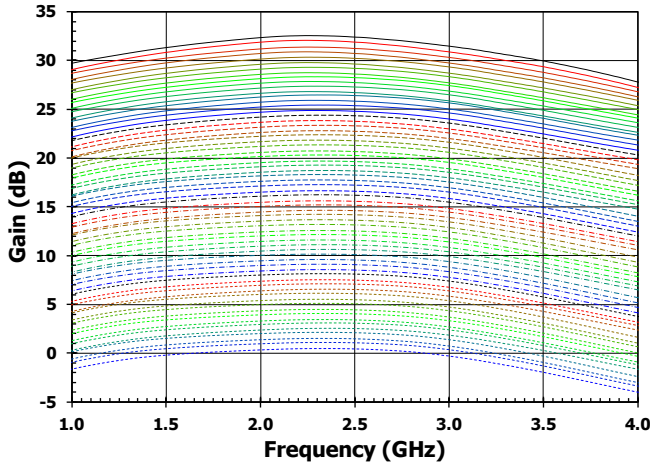

Figure 10. Gain vs. Attenuation over Temperature and Voltage [2.65 GHz]

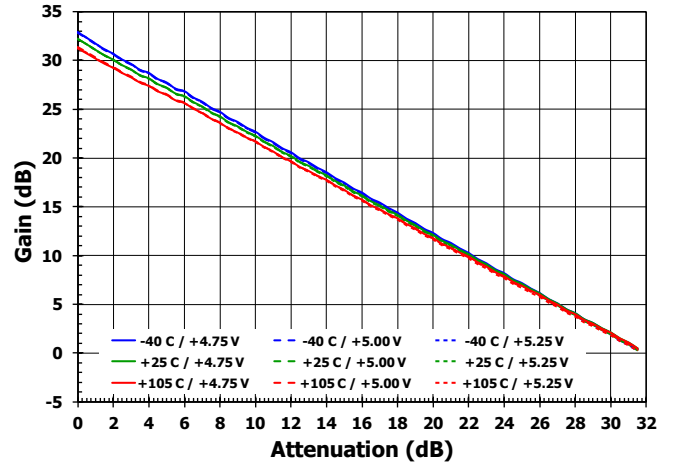

Figure 11. Worst Case Attenuator Absolute Accuracy vs. Freq [All parameters]

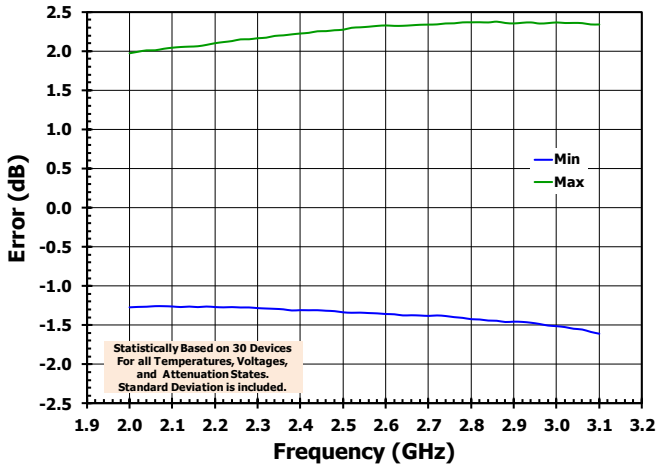

Figure 12. Attenuator Absolute Accuracy vs. Atten over Temp and Voltage [2.65 GHz]

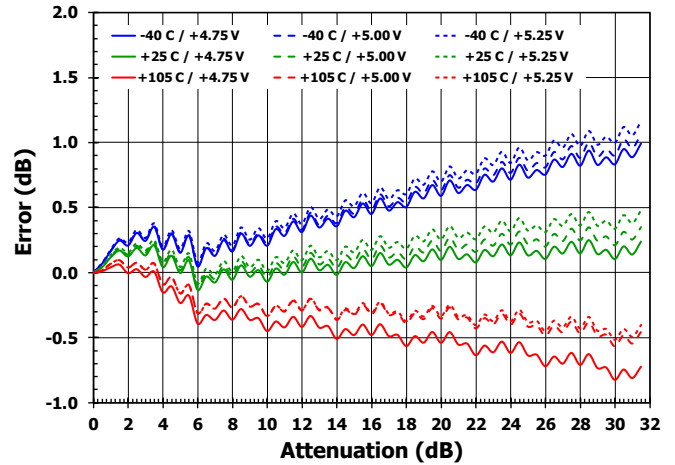

Figure 13. Worst Case Step Accuracy vs. Freq [All parameters]

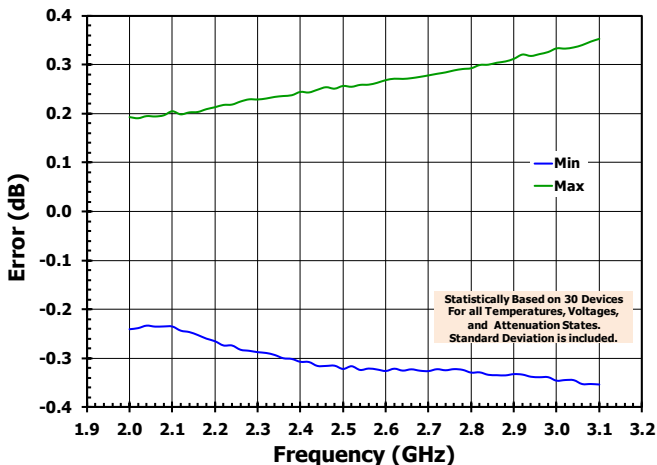
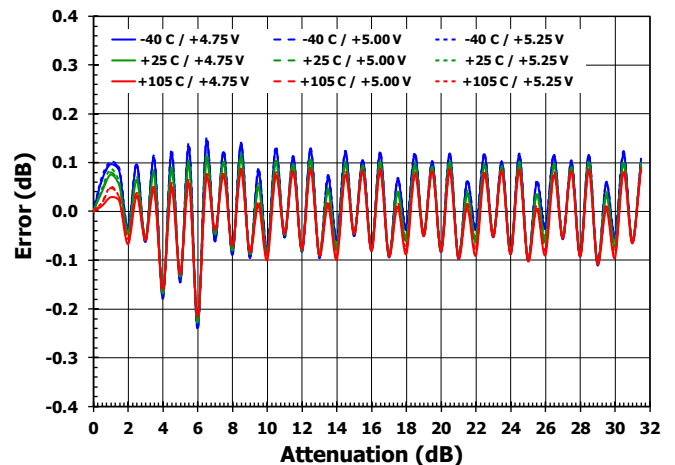

Figure 14. Step Accuracy vs. Attenuation over Temperature and Voltage [2.65 GHz]



Typical Performance Characteristics

Figure 15. Input Return Loss vs. Frequency
[+25 °C, All states]

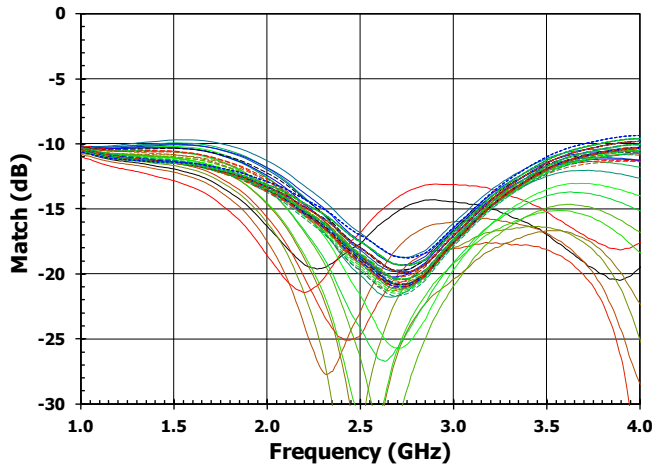

Figure 17. Output Return Loss vs. Frequency
[+25 °C, All states]

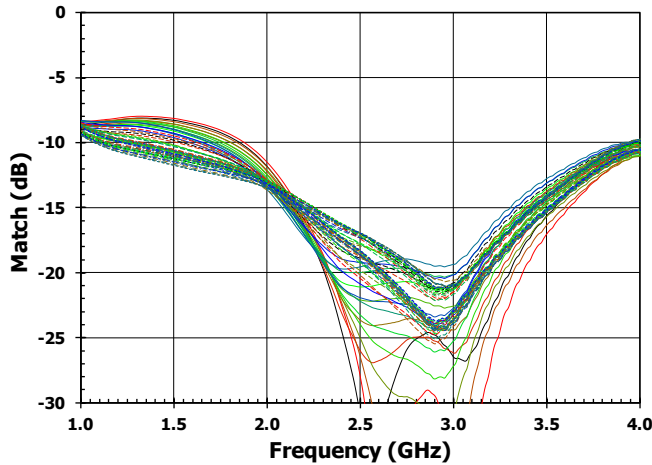

Figure 19. Reverse Isolation vs. Frequency
[+25 °C, All states]

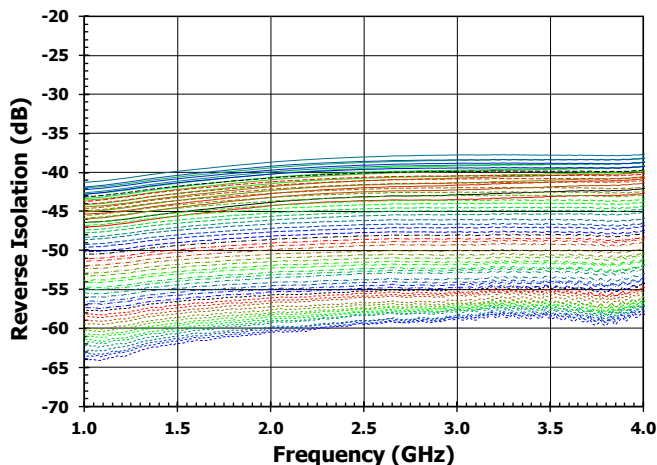

Figure 16. Input Return Loss vs. Attenuation
over Temperature and Voltage [2.65 GHz]

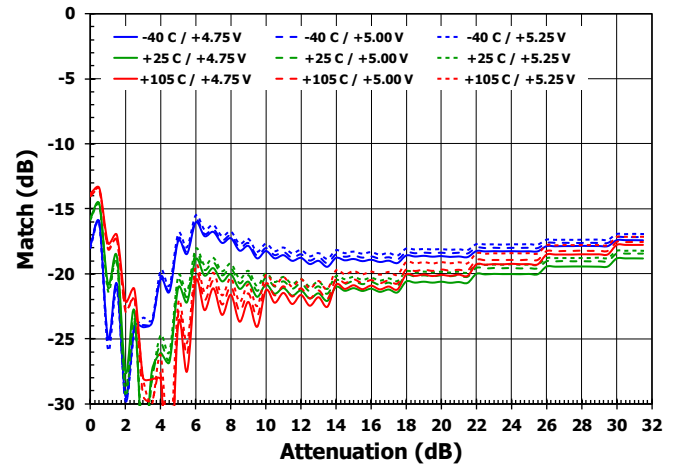

Figure 18. Output Return Loss vs. Attenuation
over Temperature and Voltage [2.65 GHz]

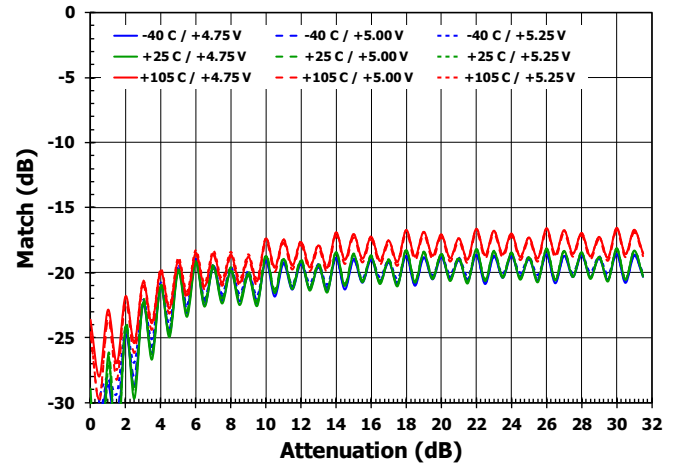
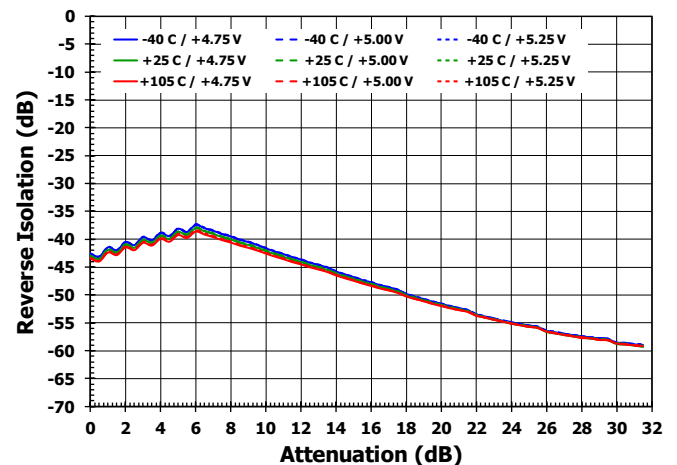

Figure 20. Reverse Isolation vs. Attenuation
over Temperature and Voltage [2.65 GHz]



Typical Performance Characteristics

Figure 21. Output IP3 vs. Attn over Temp and Voltage [2.3 GHz] (Test Note TN1)

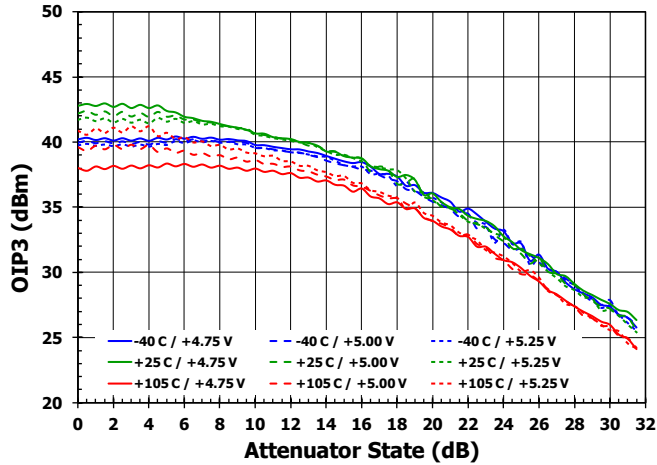

Figure 23. Output IP3 vs. Attn over Temp and Voltage [2.5 GHz] (Test Note TN1)

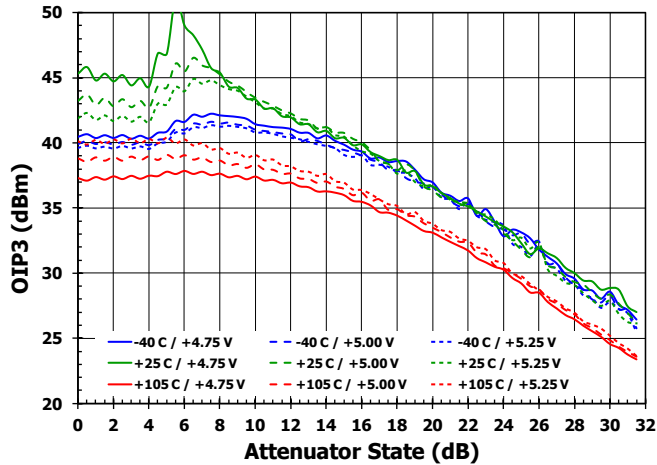

Figure 25. Output IP3 vs. Attn over Temp and Voltage [2.65 GHz] (Test Note TN1)

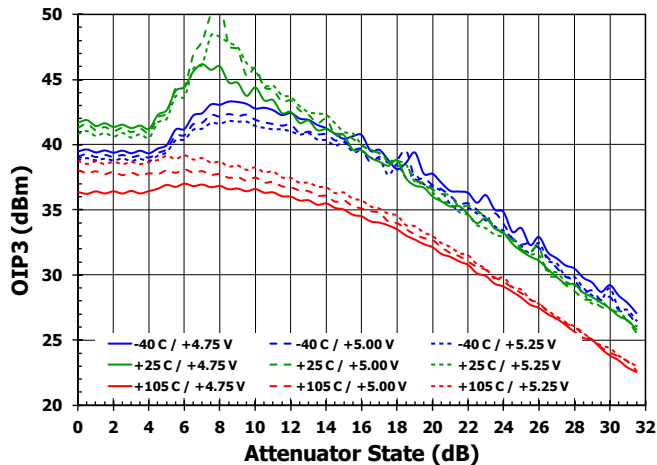

Figure 22. Output IP3 vs. Attn over Temp and Voltage [2.3 GHz] (Test Note TN2)

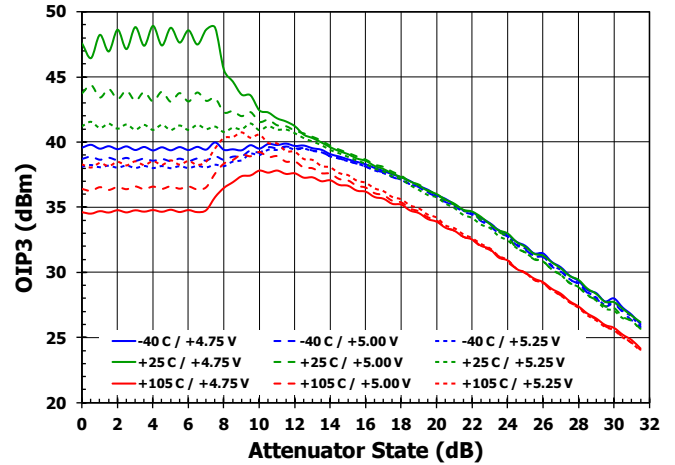

Figure 24. Output IP3 vs. Attn over Temp and Voltage [2.5 GHz] (Test Note TN2)

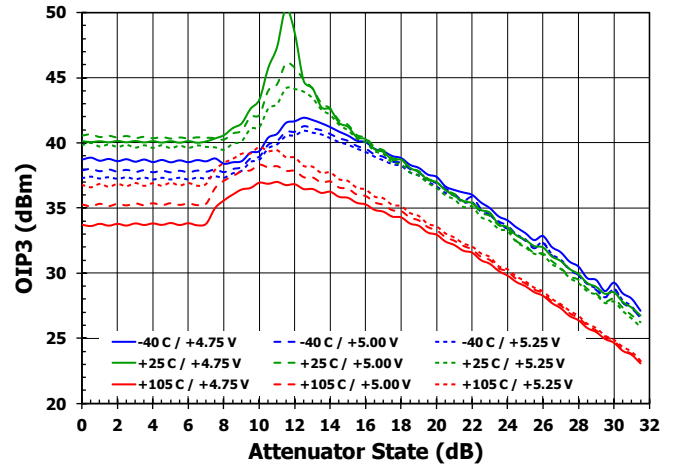
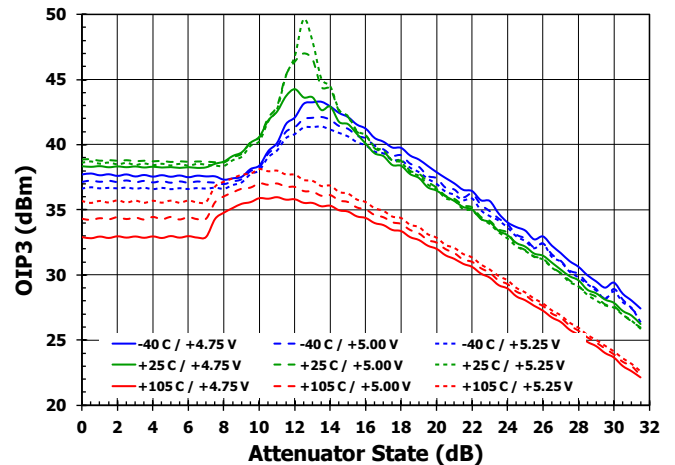

Figure 26. Output IP3 vs. Attn over Temp and Voltage [2.65 GHz] (Test Note TN2)



Typical Performance Characteristics

Figure 27. Output IP3 vs. Frequency over Temperature and Voltage [Attn = 0.0 dB]

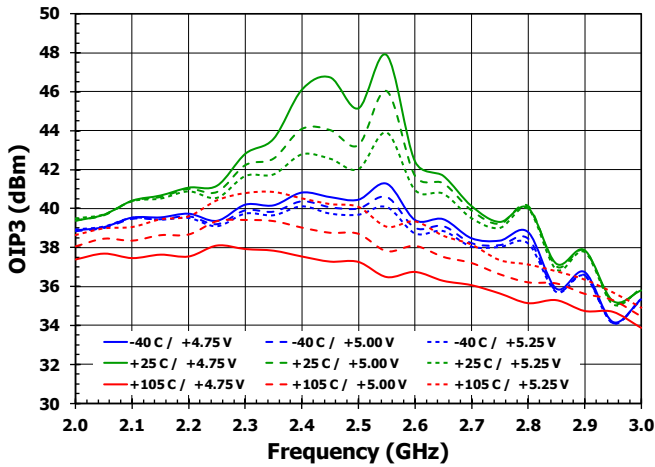

Figure 29. Output P1dB vs. Frequency over Temp and Voltage [Attn = 0.0 dB]

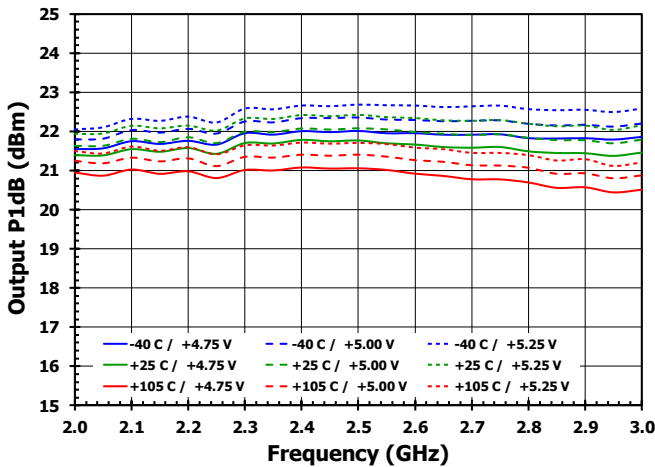

Figure 28. Output P1dB vs. Attenuation over Temperature and Voltage [2.3 GHz]

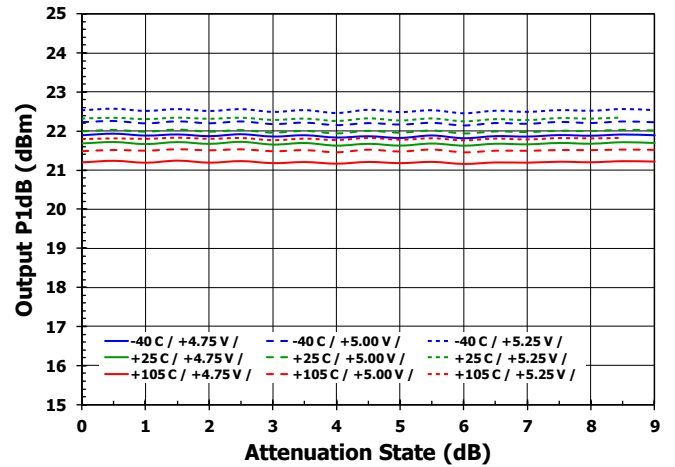

Figure 30. Output P1dB vs. Attenuation over Temp and Voltage [2.5 GHz]

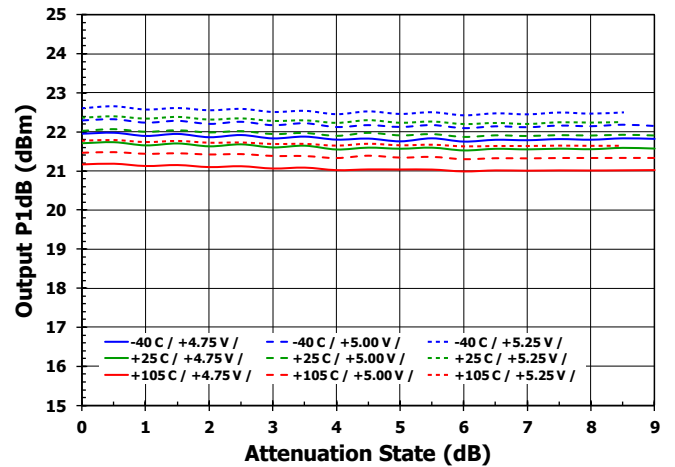
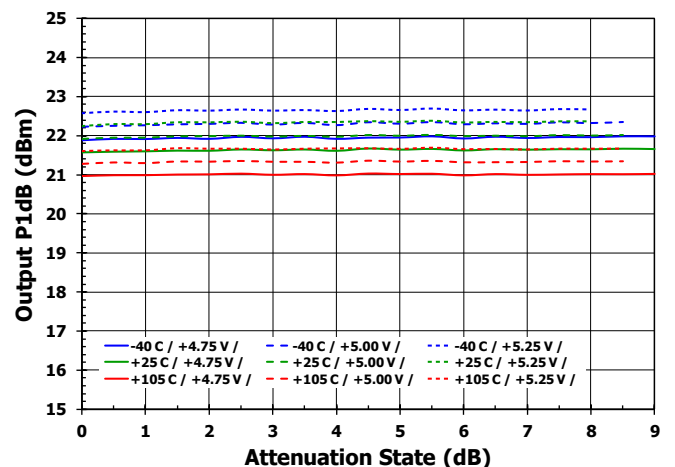

Figure 31. Output P1dB vs. Attenuation over Temp and Voltage [2.65 GHz]



Typical Performance Characteristics

Figure 32. Gain Compression vs. Pout over Temperature and Voltage [2.3 GHz]

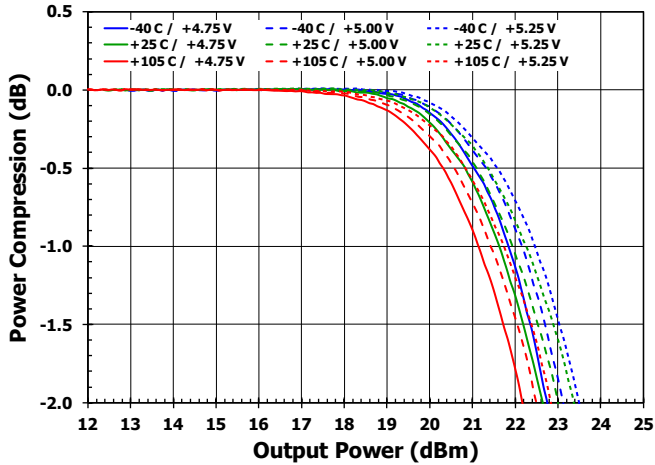

Figure 33. Phase Compression vs. Pout over Temperature and Voltage [2.3 GHz]

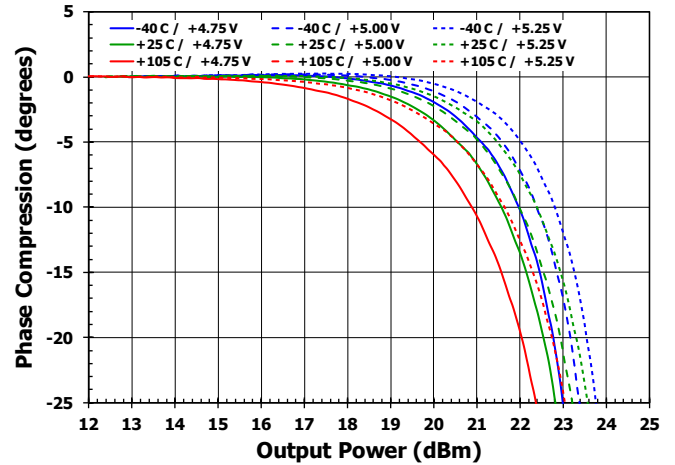

Figure 34. Gain Compression vs. Pout over Temperature and Voltage [2.5 GHz]

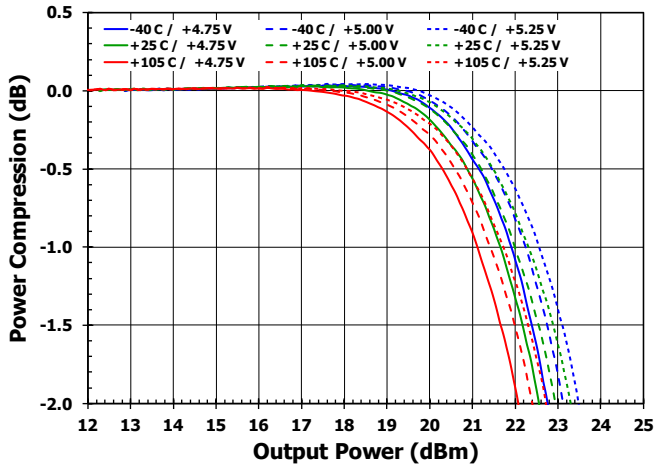

Figure 35. Phase Compression vs. Pout over Temperature and Voltage [2.5 GHz]

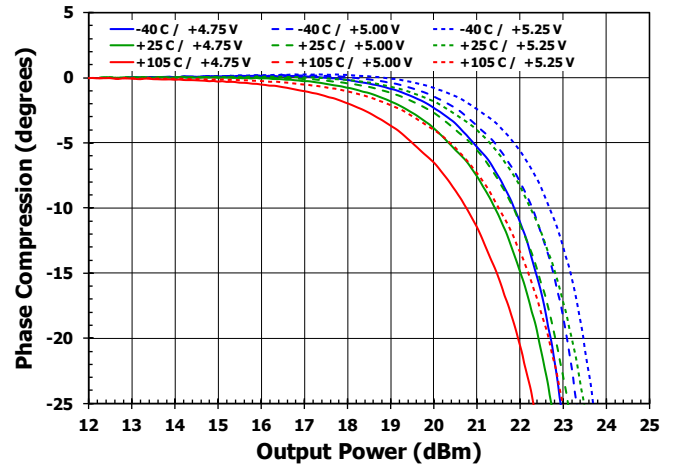

Figure 36. Gain Compression vs. Pout over Temperature and Voltage [2.65 GHz]

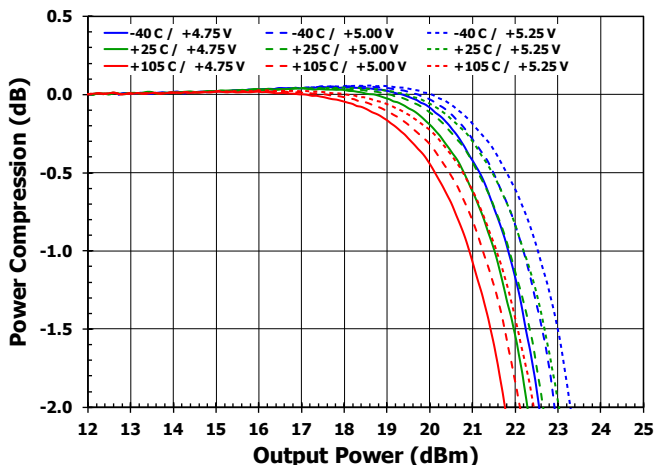
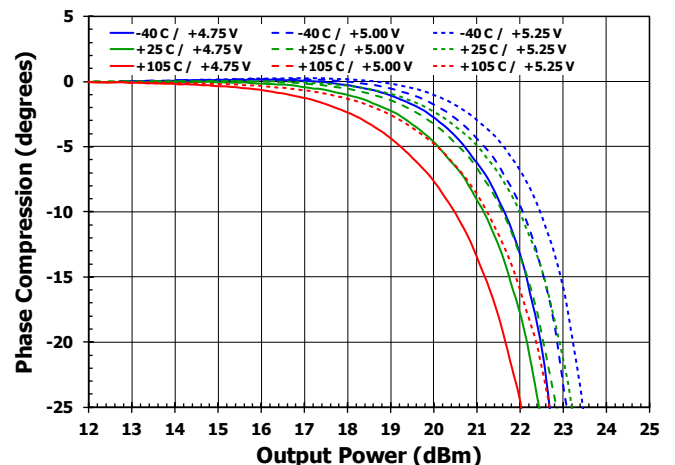

Figure 37. Phase Compression vs. Pout over Temperature and Voltage [2.65 GHz]



Typical Performance Characteristics

Figure 38. Noise Figure vs. Frequency over Temperature and Voltage [Attn = 0.0 dB]

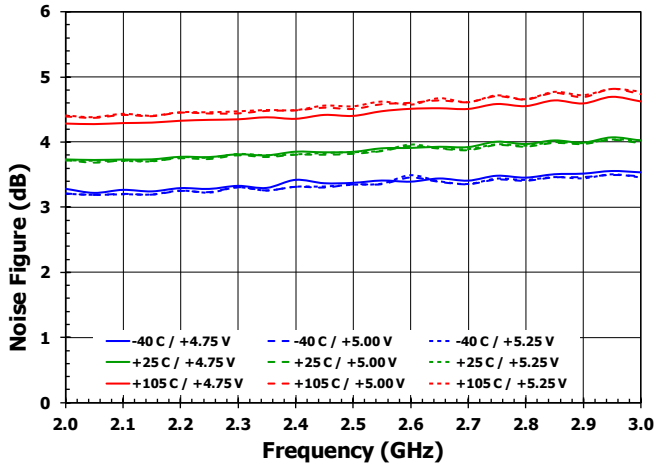

Figure 39. Noise Figure vs. Attenuation over Temperature and Voltage [2.3 GHz]

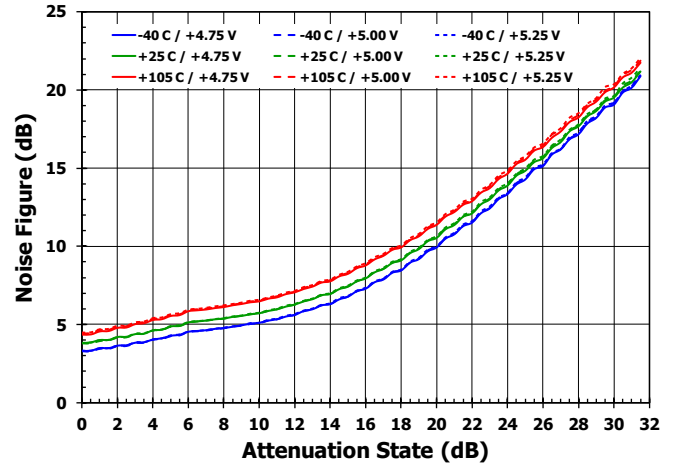

Figure 40. Noise Figure vs. Attenuation over Temperature and Voltage [2.5 GHz]

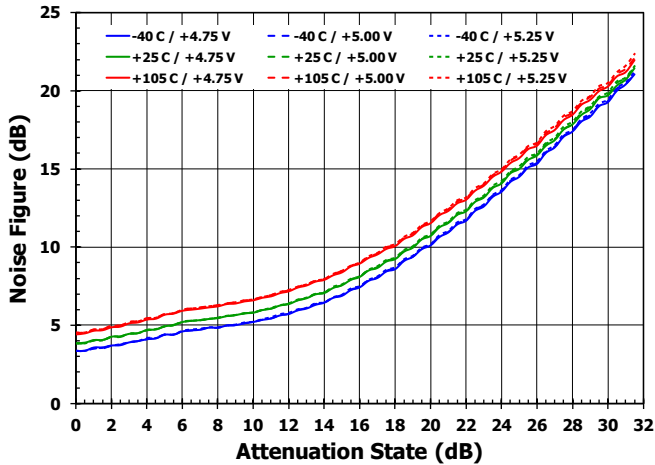
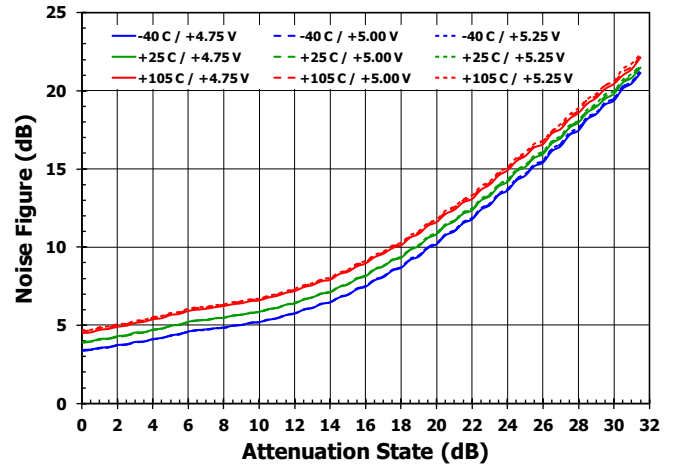

Figure 41. Noise Figure vs. Attenuation over Temperature and Voltage [2.65 GHz]



Typical Performance Characteristics

Figure 42. Switching Speed 0.0 to 31.5 dB

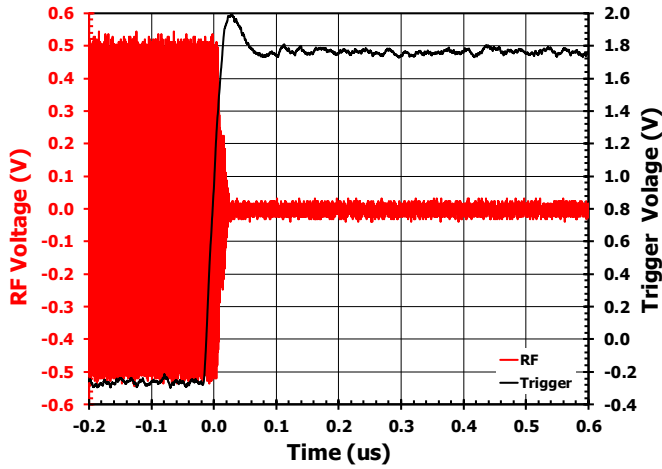

Figure 43. Switching Speed 31.5 to 0.0 dB

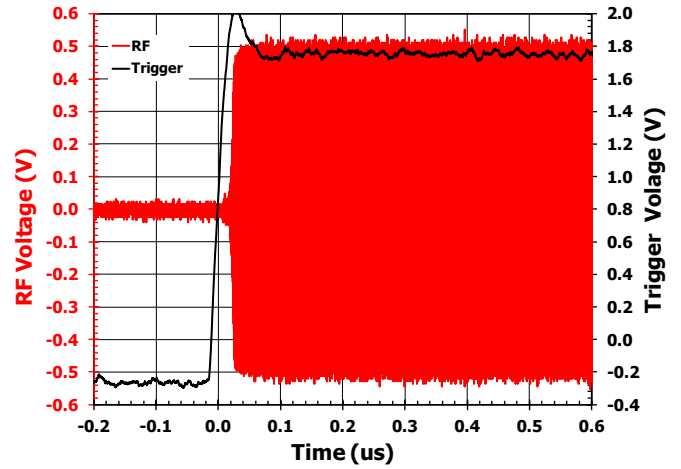

Figure 44. Switching Speed Standby Mode to Full Operation Mode

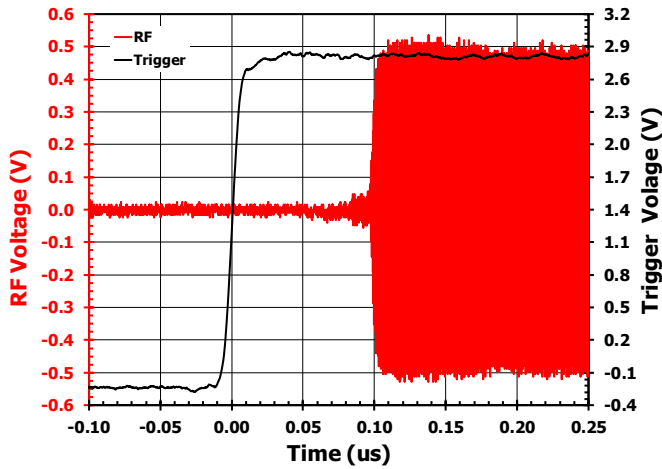
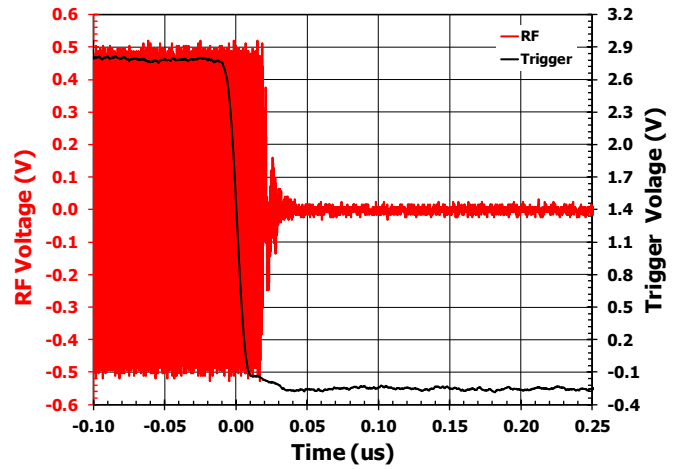
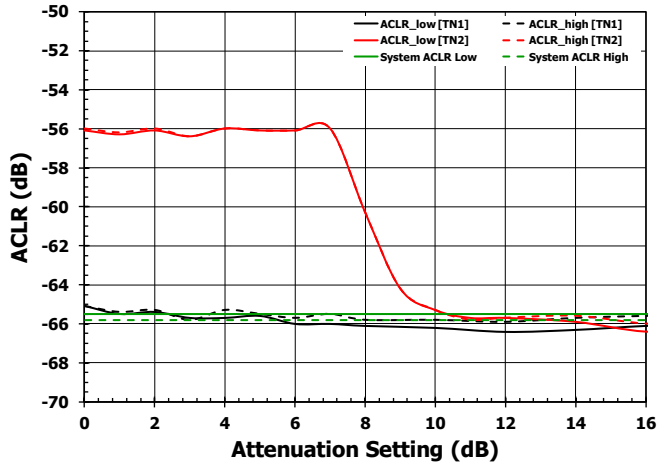
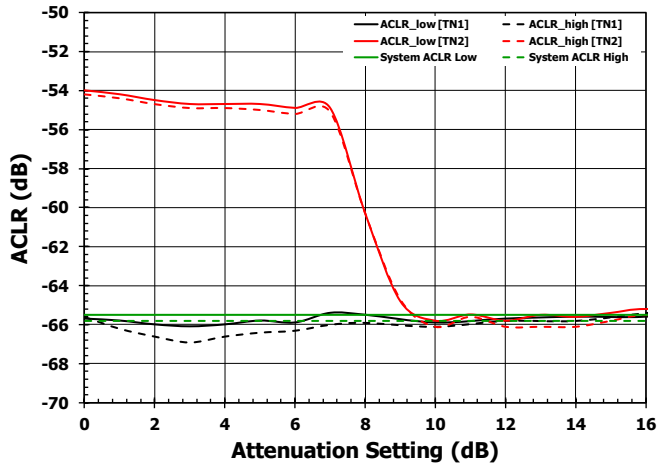
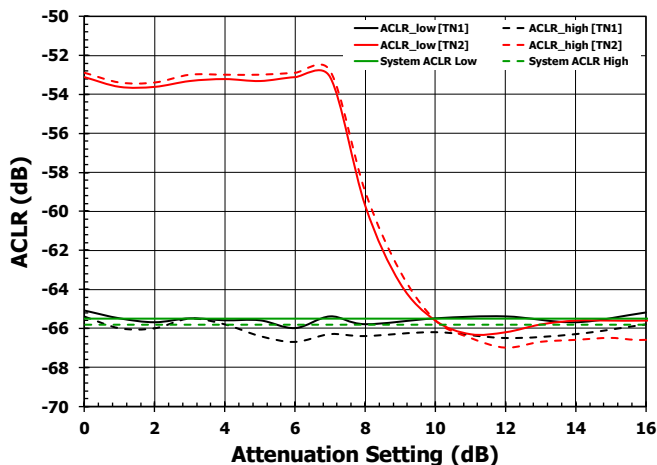
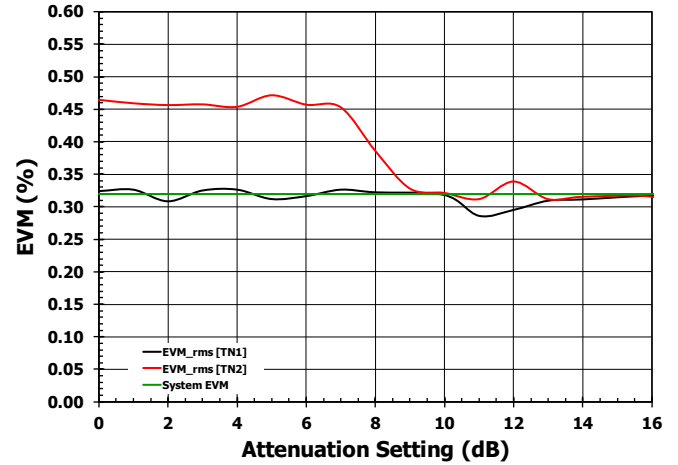
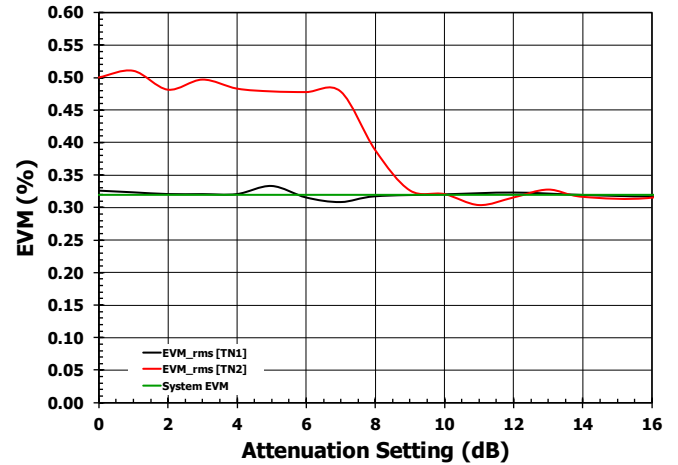
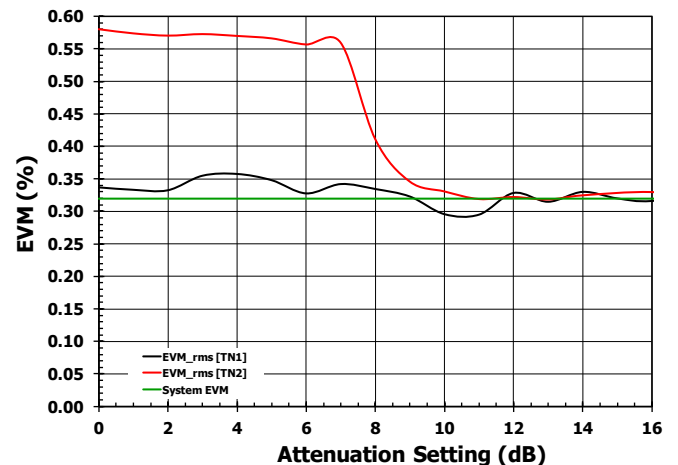

Figure 45. Switching Speed Full Operation Mode to Standby Mode



Typical Performance Characteristics

Figure 46. ACLR vs. Attn [2.3 GHz]

Figure 48. ACLR vs. Attn [2.5 GHz]

Figure 50. ACLR vs. Attn [2.65 GHz]

Figure 47. EVM (RMS) vs. Attn [2.3 GHz]

Figure 49. EVM (RMS) vs. Attn [2.5 GHz]

Figure 51. EVM (RMS) vs. Attn [2.65GHz]

Serial Port Interface

Serial data is formatted as a 6-bit word clocking data in MSB first.

Table 7. Attenuation Word Truth Table

Control Bit						Attenuator Setting
D5	D4	D3	D2	D1	D0	
1	1	1	1	1	1	0.0 dB
1	1	1	1	1	0	0.5 dB
1	1	1	1	0	1	1.0 dB
1	1	1	0	1	1	2.0 dB
1	1	0	1	1	1	4.0 dB
1	0	1	1	1	1	8.0 dB
0	1	1	1	1	1	16.0 dB
0	0	0	0	0	0	31.5 dB

Figure 52. Serial Register Timing Diagram

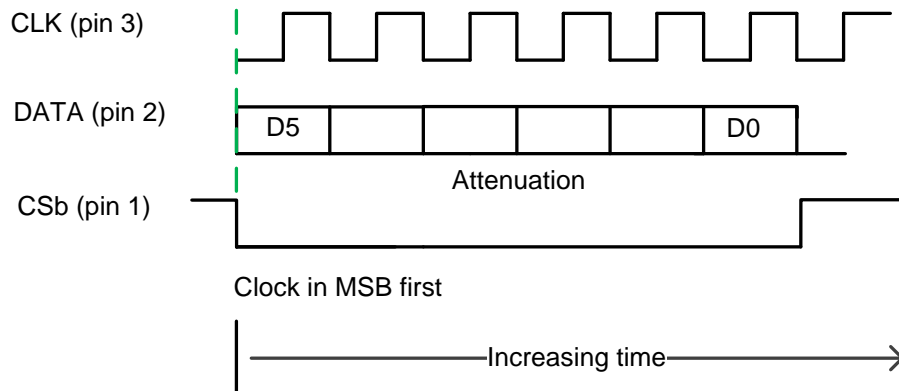
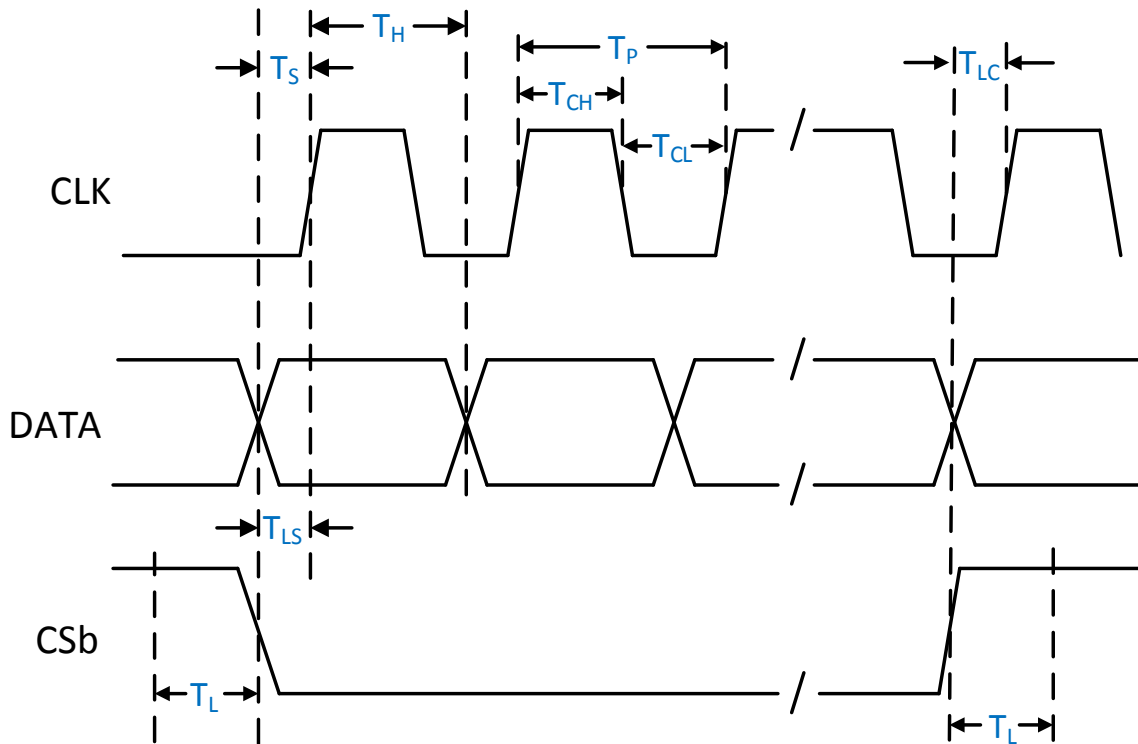

Figure 53. SPI Timing Diagram

Table 8. SPI Timing Diagram Values for Figure 53

Parameter	Symbol	Test Condition	Min	Typ	Max	Units
CLK Frequency	F_C				25	MHz
CLK High Duration Time	T_{CH}		20			ns
CLK Low Duration Time	T_{CL}		20			ns
DATA to CLK Setup Time	T_S		5			ns
CLK Period [a]	T_P		40			ns
CLK to DATA Hold Time	T_H		5			ns
CSb to CLK Setup Time	T_{LS}		5			ns
CSb Trigger Pulse Width	T_L		10			ns
CSb Trigger to CLK Setup Time [b]	T_{LC}		5			ns

a. $(T_{CH} + T_{CL}) \geq 1/F_C$

b. Once all desired DATA is clocked in, T_{LC} represents the time a CSb high needs to occur before any subsequent CLK signals.

Table 9. Standby Truth Table

/STBY (pin 14)	Condition
0 V	Amplifier OFF with SPI powered ON
V_{CC}	Full operation

Application Information

The F1456 has been optimized for use in high performance RF applications from 2100 MHz to 2950 MHz. The device maintains good performance outside of the optimized band as shown by the Typical Performance Characteristics.

Power Up Attenuation Setting

When the part is initially powered up, the default VGA setting is the 31.5 dB [000000] attenuation state.

Chip Select (CSb)

When CSb is set to logic high, the CLK input is disabled. When CSb is set to logic low, the CLK input is enabled and the DATA word can be programmed into the shift registers. The programmed word is then latched into the F1456 on the CSb rising edge (refer Figure 53). The operation of the SPI bus is independent of the /STBY pin setting (see Standby Mode section below).

Standby Mode (/STBY)

The F1456 has a power down feature for power savings which is on Pin 14. For normal operation pin 14 must be set to a logic high. When a logic low is applied to pin 14 the amplifier is placed in standby mode. The Standby mode is a high isolation state. The level of this isolation is not specified and is dependent on the device and attenuation state. In Standby mode the SPI bus is operational and the device attenuation setting can be programmed. Therefore, the device will present the desired attenuation when it is enabled.

Power Supplies

A common V_{CC} power supply should be used for all power supply pins. To minimize noise and fast transients de-coupling capacitors to all supply pins. Supply noise can degrade noise figure and fast transients can trigger ESD clamps causing them to fail. Supply voltage change or transients should have a slew rate smaller than $1\text{ V} / 20\ \mu\text{s}$. In addition, all control pins should remain at $0\text{ V} (\pm 0.3\text{ V})$ while the supply voltage ramps or while it returns to zero.

Control Pin Interface

If control signal integrity is a concern and clean signals cannot be guaranteed due to overshoot, undershoot, ringing, etc., the following circuit at the input of each control pin is recommended. This applies to SPI and control pins 1, 2, 3 and 14 as shown below. Note the recommended resistor and capacitor values do not necessarily match the EV kit BOM for the case of poor control signal integrity. For multiple devices driven by a single control line, the component values will need to be adjusted accordingly so as not to load down the control line.

Figure 54. Control Pin Interface for Signal Integrity

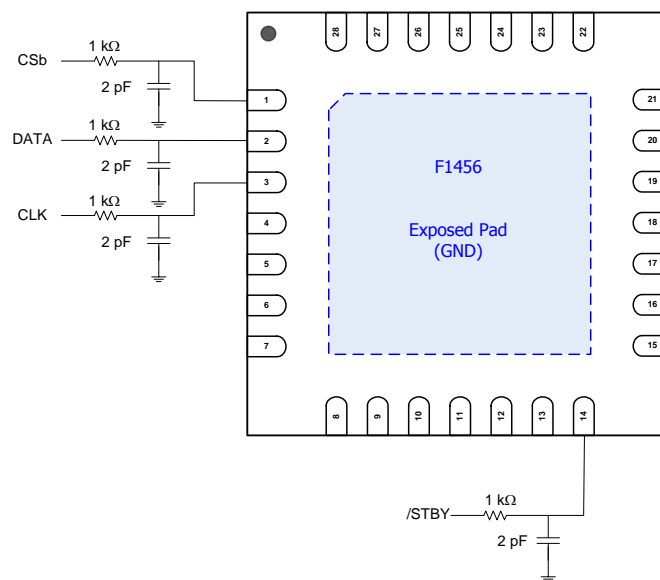

Evaluation Kit Picture

Figure 55. Top View

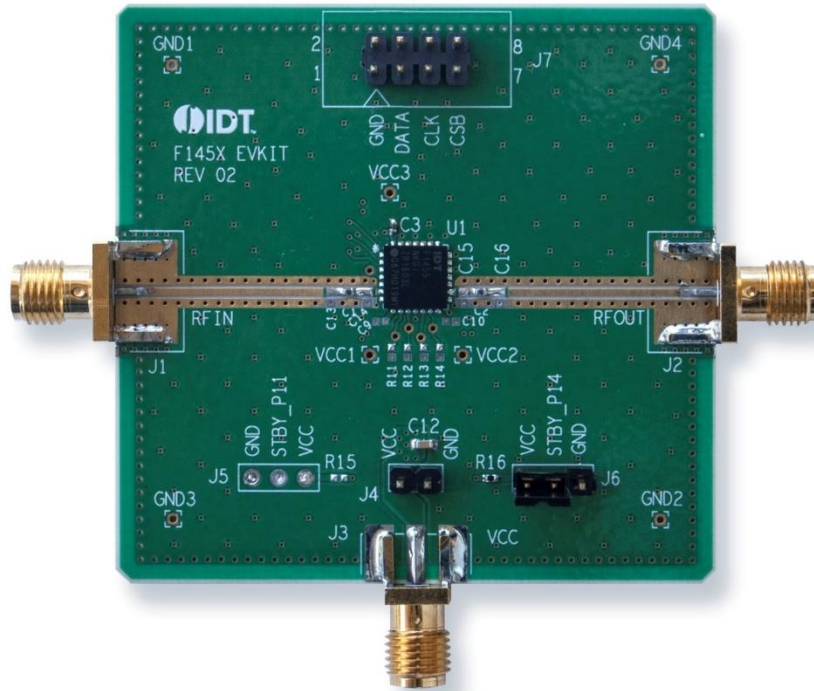
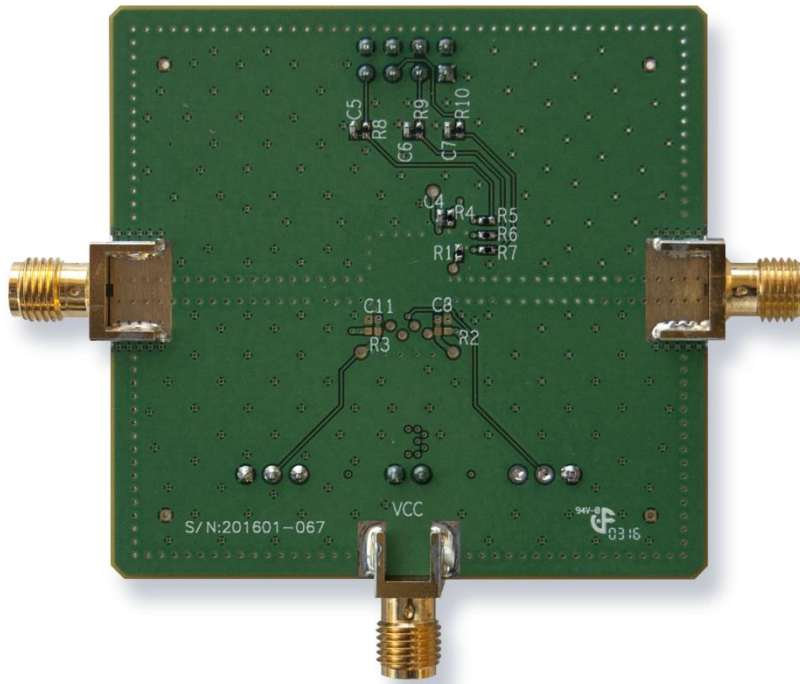
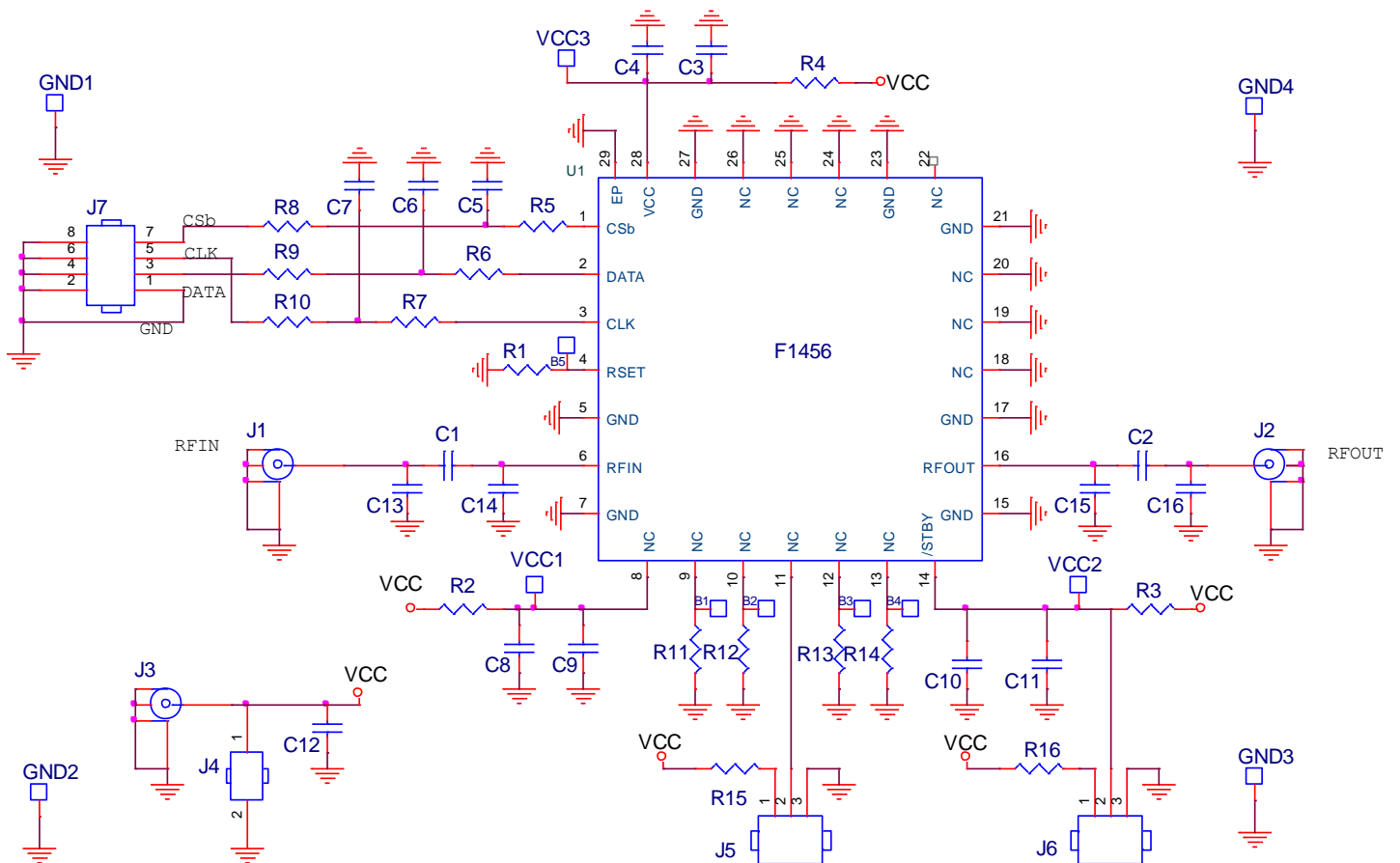

Figure 56. Bottom View



Evaluation Kit / Applications Circuit

Figure 57. Electrical Schematic



Not All Components are used. Please check the Bill of Material (BOM) table.

Table 10. Bill of Material (BOM)

Part Reference	QTY	Description	Manufacturer Part #	Manufacturer
C1, C2	2	22 pF \pm 5%, 50V, C0G Ceramic Capacitor (0402)	GRM1555C1H220J	MURATA
C3	1	100 nF \pm 10%, 16V, X7R Ceramic Capacitor (0402)	GRM155R71C104K	MURATA
C4	1	1000 pF \pm 5%, 50V, C0G Ceramic Capacitor (0402)	GRM1555C1H102J	MURATA
C5, C6, C7	3	2 pF \pm 0.1pF, 50V, C0G Ceramic Capacitor (0402)	GRM1555C1H2R0B	MURATA
C12	1	10 uF \pm 20%, 16V, X6S Ceramic Capacitor (0603)	GRM188C81C106M	MURATA
R1	1	2.2 k Ω \pm 1%, 1/10W, Resistor (0402)	ERJ-2RKF2201X	PANASONIC
R4 - R7	4	0 Ω Resistor (0402)	ERJ-2GE0R00X	PANASONIC
R8 - R10, R16	4	1 k Ω \pm 1%, 1/10W, Resistor (0402)	ERJ-2RKF1001X	PANASONIC
J4	1	CONN HEADER VERT SGL 2 X 1 POS GOLD	961102-6404-AR	3M
J6	1	CONN HEADER VERT SGL 3 X 1 POS GOLD	961103-6404-AR	3M
J7	1	CONN HEADER VERT DBL 4 X 2 POS GOLD	67997-108HLF	FCI
J1, J2	2	Edge Launch SMA (0.375 inch pitch ground, tab)	142-0701-851	Emerson Johnson
J3	1	Edge Launch SMA (0.250 inch pitch ground, round)	142-0711-821	Emerson Johnson
U1	1	VGA AMP	F1456NKGK	IDT
C8 - C11, C13 - C16, R2, R3, R11 - R15, J5		DNP		
	1	Printed Circuit Board	F145X EVKIT REV 02	

Evaluation Kit Operation

Standby

Connector J6 allows the F1456 to be put into the standby mode. Connecting J6 pin 2 (the center pin) to V_{cc} the amplifier will be placed in normal operating mode. To put the F1456 into standby mode for very low power consumption ground J6 pin 2 (the center pin). If J6 pin 2 (the center pin) is left open, then the F1456 will default to the standby mode.

Figure 58. Image of J6 connector for Standby mode control

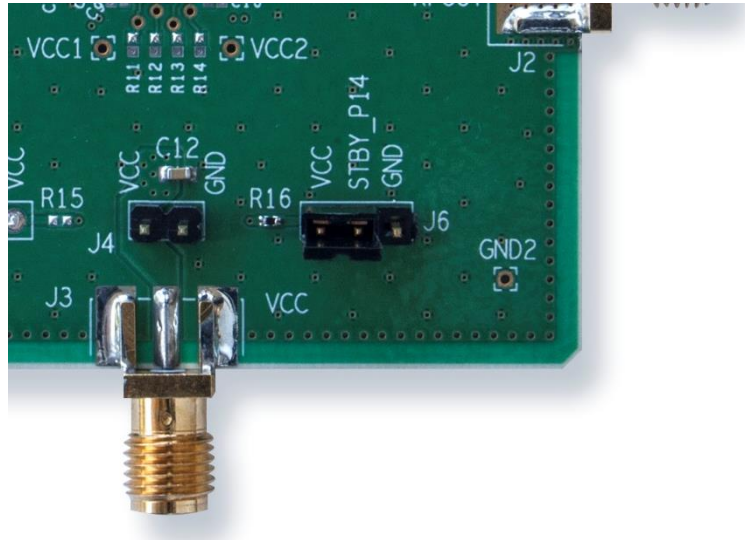

Serial Programming Pins

Connector J7 pins 1, 2, 4, 6, 8 are ground. Pin 3 is DATA, pin 5 is Clock (CLK), pin 7 is Chip Select (CSB).

Figure 59. Image of J7 connector for SPI

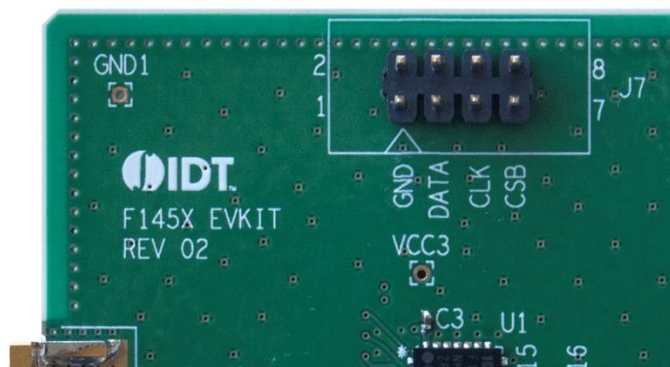

Package Drawings

Figure 60. Package Outline Drawing NKG28 PSC-4606

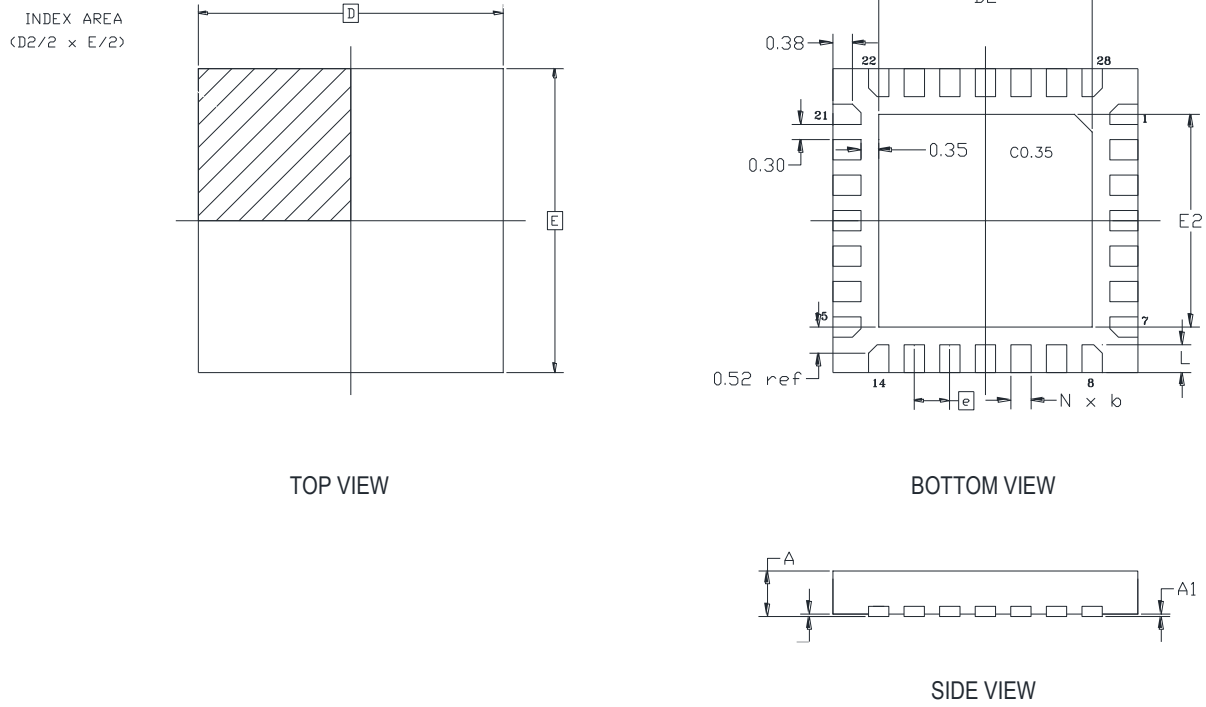

SYMBOL	DIMENSION		
	MIN	NOM	MAX
D2	4.10	4.20	4.30
E2	4.10	4.20	4.30
L	0.45	0.55	0.65
D	6.00 BSC		
E	6.00 BSC		
e	0.70 BSC		
A	0.80	0.90	1.00
A1	0.00	0.02	0.05
b	0.35	0.40	0.45
N	28		
aaa	0.15		
bbb	0.10		
ccc	0.10		
ddd	0.05		
eee	0.08		
fff	0.10		

NOTES:

1. ALL DIMENSIONING AND TOLERANCING CONFORM TO ANSI Y14.5M-1982
2. ALL DIMENSIONS ARE IN MILLIMETERS.

Recommended Land Pattern

Figure 61. Recommended Land Pattern

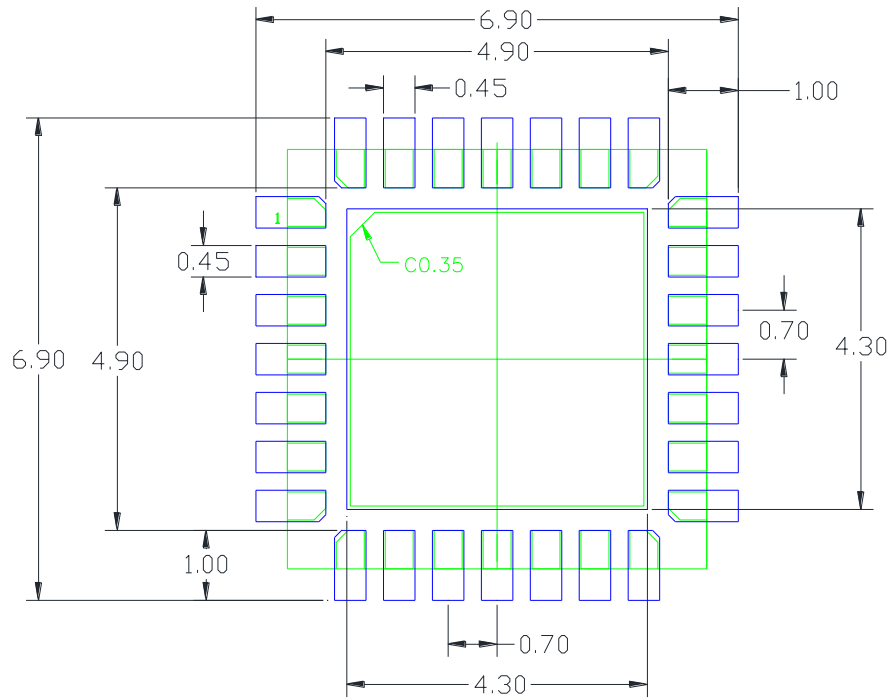

RECOMMENDED LAND PATTERN DIMENSION

NOTES:

1. ALL DIMENSIONS ARE IN mm. ANGLES IN DEGREES.
2. TOP DOWN VIEW, AS VIEWED ON PCB.
3. COMPONENT OUTLINE IS SHOWN FOR REFERENCE IN GREEN.
4. LAND PATTERN IN BLUE. NSMD PATTERN ASSUMED.
5. LAND PATTERN RECOMMENDATION PER IPC-7351B GENERIC REQUIREMENT FOR SURFACE MOUNT DESIGN AND LAND PATTERN.

Ordering Information

Orderable Part Number	Package	MSL Rating	Shipping Packaging	Temperature
F1456NKGK	6 x 6 x 0.9 mm QFPN	1	Tray	-40° to +105°C
F1456NKGK8	6 x 6 x 0.9 mm QFPN	1	Tape and Reel	-40° to +105°C
F1456EVBK	Evaluation Board			
F1456EVSK	Evaluation Solution			

Marking Diagram



1. Line 2 and 3 are the part number.
2. Line 4 "ZW" is Assembly Stepping.
3. Line 4 "yyww = 1629" has two digits for the year and week that the part was assembled.
4. Line 4 "L" denotes Assembly Site.
5. Line 5 "Q54E042PY" is the Assembly Lot number

Revision History

Revision	Revision Date	Description of Change
0	2016-November 09	Initial Release

**Corporate Headquarters**

6024 Silver Creek Valley Road
San Jose, CA 95138
www.IDT.com

Sales

1-800-345-7015 or 408-284-8200
Fax: 408-284-2775
www.IDT.com/go/sales

Tech Support

www.IDT.com/go/support

DISCLAIMER Integrated Device Technology, Inc. (IDT) reserves the right to modify the products and/or specifications described herein at any time, without notice, at IDT's sole discretion. Performance specifications and operating parameters of the described products are determined in an independent state and are not guaranteed to perform the same way when installed in customer products. The information contained herein is provided without representation or warranty of any kind, whether express or implied, including, but not limited to, the suitability of IDT's products for any particular purpose, an implied warranty of merchantability, or non-infringement of the intellectual property rights of others. This document is presented only as a guide and does not convey any license under intellectual property rights of IDT or any third parties.

IDT's products are not intended for use in applications involving extreme environmental conditions or in life support systems or similar devices where the failure or malfunction of an IDT product can be reasonably expected to significantly affect the health or safety of users. Anyone using an IDT product in such a manner does so at their own risk, absent an express, written agreement by IDT.

Integrated Device Technology, IDT and the IDT logo are trademarks or registered trademarks of IDT and its subsidiaries in the United States and other countries. Other trademarks used herein are the property of IDT or their respective third party owners. For datasheet type definitions and a glossary of common terms, visit www.idt.com/go/glossary. All contents of this document are copyright of Integrated Device Technology, Inc. All rights reserved



Компания «ЭлектроПласт» предлагает заключение долгосрочных отношений при поставках импортных электронных компонентов на взаимовыгодных условиях!

Наши преимущества:

- Оперативные поставки широкого спектра электронных компонентов отечественного и импортного производства напрямую от производителей и с крупнейших мировых складов;
- Поставка более 17-ти миллионов наименований электронных компонентов;
- Поставка сложных, дефицитных, либо снятых с производства позиций;
- Оперативные сроки поставки под заказ (от 5 рабочих дней);
- Экспресс доставка в любую точку России;
- Техническая поддержка проекта, помощь в подборе аналогов, поставка прототипов;
- Система менеджмента качества сертифицирована по Международному стандарту ISO 9001;
- Лицензия ФСБ на осуществление работ с использованием сведений, составляющих государственную тайну;
- Поставка специализированных компонентов (Xilinx, Altera, Analog Devices, Intersil, Interpoint, Microsemi, Aeroflex, Peregrine, Syfer, Eurofarad, Texas Instrument, Miteq, Cobham, E2V, MA-COM, Hittite, Mini-Circuits, General Dynamics и др.);

Помимо этого, одним из направлений компании «ЭлектроПласт» является направление «Источники питания». Мы предлагаем Вам помощь Конструкторского отдела:

- Подбор оптимального решения, техническое обоснование при выборе компонента;
- Подбор аналогов;
- Консультации по применению компонента;
- Поставка образцов и прототипов;
- Техническая поддержка проекта;
- Защита от снятия компонента с производства.



Как с нами связаться

Телефон: 8 (812) 309 58 32 (многоканальный)

Факс: 8 (812) 320-02-42

Электронная почта: org@eplast1.ru

Адрес: 198099, г. Санкт-Петербург, ул. Калинина, дом 2, корпус 4, литера А.