

---

---

## 32-bit Cortex M0+ with 5V support and PTC

---

---

### Introduction

---

The SAM C20 is a series of microcontrollers optimized for industrial automation, appliances and other 5V applications using the 32-bit ARM<sup>®</sup> Cortex<sup>®</sup>-M0+ processor, ranging from 32- to 100-pins with up to 256KB Flash and 32KB of SRAM and operate at a maximum frequency of 48MHz and reach 2.46 CoreMark<sup>®</sup>/MHz. The SAM C20 devices are designed for simple and intuitive migration with identical peripheral modules, hex compatible code, identical linear address map and pin compatible migration paths between all devices in the product series. All devices include intelligent and flexible peripherals, Event System for inter-peripheral signaling, and support for capacitive touch button, slider and wheel user interfaces.

SAM C20 devices are pin compatible to the SAM D and SAM C family of general purpose microcontrollers.

### Features

---

- Processor
  - ARM Cortex-M0+ CPU running at up to 48MHz
    - Single-cycle hardware multiplier
    - Micro Trace Buffer
    - Memory Protection Unit (MPU)
- Memories
  - 32/64/128/256KB in-system self-programmable Flash
  - 1/2/4/8KB independent self-programmable Flash for EEPROM emulation
  - 4/8/16/32KB SRAM Main Memory
- System
  - Power-on reset (POR) and brown-out detection (BOD)
  - Internal and external clock options with 48MHz to 96MHz Fractional Digital Phase Locked Loop (FDPLL96M)
  - External Interrupt Controller (EIC) (Interrupt pin debouncing is only available in SAM C21N)
  - 16 external interrupts
    - Hardware debouncing (only on the 100Pin TQFP)
  - One non-maskable interrupt
  - Two-pin Serial Wire Debug (SWD) programming, test and debugging interface
- Low Power
  - Idle and standby sleep modes
  - SleepWalking peripherals
- Peripherals
  - Hardware Divide and Square Root Accelerator (DIVAS)

- 12-channel Direct Memory Access Controller (DMAC)
- 12-channel Event System
- Up to eight 16-bit Timer/Counters (TC), configurable as either<sup>(2)</sup>:
  - One 16-bit TC with compare/capture channels
  - One 8-bit TC with compare/capture channels
  - One 32-bit TC with compare/capture channels, by using two TCs
- Two 24-bit Timer/Counters and one 16-bit Timer/Counter for Control (TCC), with extended functions:
  - Up to four compare channels with optional complementary output
  - Generation of synchronized pulse width modulation (PWM) pattern across port pins
  - Deterministic fault protection, fast decay and configurable dead-time between complementary output
  - Dithering that increase resolution with up to 5 bit and reduce quantization error
- Frequency Meter
- 32-bit Real Time Counter (RTC) with clock/calendar function
- Watchdog Timer (WDT)
- CRC-32 generator
- Up to eight Serial Communication Interfaces (SERCOM), each configurable to operate as either:
  - USART with full-duplex and single-wire half-duplex configuration
  - I<sup>2</sup>C up to 3.4MHz (Except SERCOM6 and SERCOM7)
  - SPI
  - LIN master/slave
  - RS-485
  - PMBus
- One Configurable Custom Logic (CCL)
- One 12-bit, 1Msps Analog-to-Digital Converter (ADC) with up to 12 channels
  - Differential and single-ended input
  - Automatic offset and gain error compensation
  - Oversampling and decimation in hardware to support 13-, 14-, 15- or 16-bit resolution
- Four Analog Comparators (AC) with window compare function
- Peripheral Touch Controller (PTC)
  - 256-Channel capacitive touch and proximity sensing
- I/O
  - Up to 84 programmable I/O pins
- Drop in compatible with SAM D20 and SAM D21<sup>(1)</sup>
- Packages
  - 100-pin TQFP
  - 64-pin TQFP, QFN
  - 56-pin WLCSP
  - 48-pin TQFP, QFN
  - 32-pin TQFP, QFN
- Operating Voltage
  - 2.7V – 5.5V

1. Only applicable for 32-, 48- and 64-pin TQFP and QFN packages.

2. Maximum and minimum capture is only available in SAM C21N

## Table of Contents

Introduction.....	1
Features.....	1
1. Description.....	13
2. Configuration Summary.....	14
3. Ordering Information.....	16
3.1. SAM C20E.....	16
3.2. SAM C20G.....	17
3.3. SAM C20J.....	18
3.4. SAM C20N.....	19
3.5. Device Identification.....	19
4. Block Diagram.....	21
5. Pinout.....	24
5.1. SAM C20E.....	24
5.2. SAM C20G.....	25
5.3. SAM C20J.....	26
5.4. SAM C20N.....	28
6. Signal Descriptions List.....	29
7. I/O Multiplexing and Considerations.....	31
7.1. Multiplexed Signals.....	31
7.2. Other Functions.....	34
8. Power Supply and Start-Up Considerations.....	37
8.1. Power Domain Overview.....	37
8.2. Power Supply Considerations.....	37
8.3. Power-Up.....	39
8.4. Power-On Reset and Brown-Out Detector.....	40
9. Product Mapping.....	41
10. Memories.....	43
10.1. Embedded Memories.....	43
10.2. Physical Memory Map.....	43
10.3. NVM User Row Mapping.....	44
10.4. NVM Software Calibration Area Mapping.....	45
10.5. Serial Number.....	46
11. Processor and Architecture.....	47
11.1. Cortex M0+ Processor.....	47

11.2. Nested Vector Interrupt Controller.....	49
11.3. Micro Trace Buffer.....	51
11.4. High-Speed Bus System.....	51
<b>12. PAC - Peripheral Access Controller.....</b>	<b>54</b>
12.1. Overview.....	54
12.2. Features.....	54
12.3. Block Diagram.....	54
12.4. Product Dependencies.....	54
12.5. Functional Description.....	55
12.6. Register Summary.....	59
12.7. Register Description.....	60
<b>13. Peripherals Configuration Summary.....</b>	<b>73</b>
13.1. SAM C20N.....	73
13.2. SAM C20J, G, E.....	75
<b>14. DSU - Device Service Unit.....</b>	<b>77</b>
14.1. Overview.....	77
14.2. Features.....	77
14.3. Block Diagram.....	77
14.4. Signal Description.....	77
14.5. Product Dependencies.....	78
14.6. Debug Operation.....	79
14.7. Chip Erase.....	80
14.8. Programming.....	81
14.9. Intellectual Property Protection.....	81
14.10. Device Identification.....	83
14.11. Functional Description.....	84
14.12. Register Summary.....	89
14.13. Register Description.....	91
<b>15. DIVAS – Divide and Square Root Accelerator.....</b>	<b>113</b>
15.1. Overview.....	113
15.2. Features.....	113
15.3. Block Diagram.....	113
15.4. Signal Description.....	113
15.5. Product Dependencies.....	113
15.6. Functional Description.....	114
15.7. Register Summary.....	117
15.8. Register Description.....	117
<b>16. Clock System.....</b>	<b>124</b>
16.1. Clock Distribution.....	124
16.2. Synchronous and Asynchronous Clocks.....	125
16.3. Register Synchronization.....	125
16.4. Enabling a Peripheral.....	127
16.5. On-demand, Clock Requests.....	127
16.6. Power Consumption vs. Speed.....	128

16.7. Clocks after Reset.....	128
<b>17. GCLK - Generic Clock Controller.....</b>	<b>129</b>
17.1. Overview.....	129
17.2. Features.....	129
17.3. Block Diagram.....	129
17.4. Signal Description.....	130
17.5. Product Dependencies.....	130
17.6. Functional Description.....	131
17.7. Register Summary.....	137
17.8. Register Description.....	138
<b>18. MCLK – Main Clock.....</b>	<b>146</b>
18.1. Overview.....	146
18.2. Features.....	146
18.3. Block Diagram.....	146
18.4. Signal Description.....	146
18.5. Product Dependencies.....	146
18.6. Functional Description.....	148
18.7. Register Summary - MCLK.....	153
18.8. Register Description.....	153
<b>19. RSTC – Reset Controller.....</b>	<b>165</b>
19.1. Overview.....	165
19.2. Features.....	165
19.3. Block Diagram.....	165
19.4. Signal Description.....	165
19.5. Product Dependencies.....	165
19.6. Functional Description.....	166
19.7. Register Summary.....	169
19.8. Register Description.....	169
<b>20. PM – Power Manager.....</b>	<b>170</b>
20.1. Overview.....	170
20.2. Features.....	170
20.3. Block Diagram.....	170
20.4. Signal Description.....	170
20.5. Product Dependencies.....	170
20.6. Functional Description.....	171
20.7. Register Summary.....	175
20.8. Register Description.....	175
<b>21. OSCCTRL – Oscillators Controller.....</b>	<b>177</b>
21.1. Overview.....	177
21.2. Features.....	177
21.3. Block Diagram.....	178
21.4. Signal Description.....	178
21.5. Product Dependencies.....	178
21.6. Functional Description.....	179

21.7. Register Summary.....	189
21.8. Register Description.....	190
<b>22. OSC32KCTRL – 32KHz Oscillators Controller.....</b>	<b>211</b>
22.1. Overview.....	211
22.2. Features.....	211
22.3. Block Diagram.....	212
22.4. Signal Description.....	212
22.5. Product Dependencies.....	212
22.6. Functional Description.....	214
22.7. Register Summary.....	220
22.8. Register Description.....	220
<b>23. SUPC – Supply Controller.....</b>	<b>233</b>
23.1. Overview.....	233
23.2. Features.....	233
23.3. Block Diagram.....	233
23.4. Signal Description.....	233
23.5. Product Dependencies.....	234
23.6. Functional Description.....	235
23.7. Register Summary.....	239
23.8. Register Description.....	239
<b>24. WDT – Watchdog Timer.....</b>	<b>249</b>
24.1. Overview.....	249
24.2. Features.....	249
24.3. Block Diagram.....	250
24.4. Signal Description.....	250
24.5. Product Dependencies.....	250
24.6. Functional Description.....	251
24.7. Register Summary.....	257
24.8. Register Description.....	257
<b>25. RTC – Real-Time Counter.....</b>	<b>264</b>
25.1. Overview.....	264
25.2. Features.....	264
25.3. Block Diagram.....	264
25.4. Signal Description.....	265
25.5. Product Dependencies.....	265
25.6. Functional Description.....	267
25.7. Register Summary - COUNT32.....	273
25.8. Register Description - COUNT32.....	273
25.9. Register Summary - COUNT16.....	284
25.10. Register Description - COUNT16.....	284
25.11. Register Summary - CLOCK.....	295
25.12. Register Description - CLOCK.....	295
<b>26. DMAC – Direct Memory Access Controller.....</b>	<b>307</b>
26.1. Overview.....	307

26.2. Features.....	307
26.3. Block Diagram.....	309
26.4. Signal Description.....	309
26.5. Product Dependencies.....	309
26.6. Functional Description.....	310
26.7. Register Summary.....	331
26.8. Register Description.....	332
26.9. Register Summary - SRAM.....	358
26.10. Register Description - SRAM.....	358
<b>27. EIC – External Interrupt Controller.....</b>	<b>365</b>
27.1. Overview.....	365
27.2. Features.....	365
27.3. Block Diagram.....	365
27.4. Signal Description.....	366
27.5. Product Dependencies.....	366
27.6. Functional Description.....	367
27.7. Register Summary.....	372
27.8. Register Description.....	373
<b>28. NVMCTRL – Non-Volatile Memory Controller.....</b>	<b>383</b>
28.1. Overview.....	383
28.2. Features.....	383
28.3. Block Diagram.....	383
28.4. Signal Description.....	384
28.5. Product Dependencies.....	384
28.6. Functional Description.....	385
28.7. Register Summary.....	393
28.8. Register Description.....	394
<b>29. PORT - I/O Pin Controller.....</b>	<b>405</b>
29.1. Overview.....	405
29.2. Features.....	405
29.3. Block Diagram.....	406
29.4. Signal Description.....	406
29.5. Product Dependencies.....	406
29.6. Functional Description.....	408
29.7. Register Summary.....	414
29.8. PORT Pin Groups and Register Repetition.....	416
29.9. Register Description.....	416
<b>30. EVSYS – Event System.....</b>	<b>434</b>
30.1. Overview.....	434
30.2. Features.....	434
30.3. Block Diagram.....	434
30.4. Signal Description.....	435
30.5. Product Dependencies.....	435
30.6. Functional Description.....	436
30.7. Register Summary.....	440



30.8. Register Description.....	441
<b>31. SERCOM – Serial Communication Interface.....</b>	<b>455</b>
31.1. Overview.....	455
31.2. Features.....	455
31.3. Block Diagram.....	456
31.4. Signal Description.....	456
31.5. Product Dependencies.....	456
31.6. Functional Description.....	458
<b>32. SERCOM USART – SERCOM Universal Synchronous and Asynchronous Receiver and Transmitter.....</b>	<b>464</b>
32.1. Overview.....	464
32.2. USART Features.....	464
32.3. Block Diagram.....	465
32.4. Signal Description.....	465
32.5. Product Dependencies.....	465
32.6. Functional Description.....	467
32.7. Register Summary.....	480
32.8. Register Description.....	480
<b>33. SERCOM SPI – SERCOM Serial Peripheral Interface.....</b>	<b>499</b>
33.1. Overview.....	499
33.2. Features.....	499
33.3. Block Diagram.....	500
33.4. Signal Description.....	500
33.5. Product Dependencies.....	500
33.6. Functional Description.....	502
33.7. Register Summary.....	511
33.8. Register Description.....	512
<b>34. SERCOM I<sup>2</sup>C – SERCOM Inter-Integrated Circuit.....</b>	<b>525</b>
34.1. Overview.....	525
34.2. Features.....	525
34.3. Block Diagram.....	526
34.4. Signal Description.....	526
34.5. Product Dependencies.....	526
34.6. Functional Description.....	528
34.7. Register Summary - I2C Slave.....	546
34.8. Register Description - I <sup>2</sup> C Slave.....	546
34.9. Register Summary - I2C Master.....	560
34.10. Register Description - I <sup>2</sup> C Master.....	561
<b>35. TC – Timer/Counter.....</b>	<b>577</b>
35.1. Overview.....	577
35.2. Features.....	577
35.3. Block Diagram.....	578
35.4. Signal Description.....	578

35.5. Product Dependencies.....	579
35.6. Functional Description.....	580
35.7. Register Description.....	596
<b>36. TCC – Timer/Counter for Control Applications.....</b>	<b>648</b>
36.1. Overview.....	648
36.2. Features.....	648
36.3. Block Diagram.....	649
36.4. Signal Description.....	649
36.5. Product Dependencies.....	650
36.6. Functional Description.....	651
36.7. Register Summary.....	685
36.8. Register Description.....	687
<b>37. CCL – Configurable Custom Logic.....</b>	<b>724</b>
37.1. Overview.....	724
37.2. Features.....	724
37.3. Block Diagram.....	725
37.4. Signal Description.....	725
37.5. Product Dependencies.....	725
37.6. Functional Description.....	727
37.7. Register Summary.....	737
37.8. Register Description.....	737
<b>38. ADC – Analog-to-Digital Converter.....</b>	<b>741</b>
38.1. Overview.....	741
38.2. Features.....	741
38.3. Block Diagram.....	742
38.4. Signal Description.....	742
38.5. Product Dependencies.....	742
38.6. Functional Description.....	744
38.7. Register Summary.....	754
38.8. Register Description.....	755
<b>39. AC – Analog Comparators.....</b>	<b>773</b>
39.1. Overview.....	773
39.2. Features.....	773
39.3. Block Diagram.....	774
39.4. Signal Description.....	774
39.5. Product Dependencies.....	774
39.6. Functional Description.....	776
39.7. Register Summary.....	785
39.8. Register Description.....	785
<b>40. PTC - Peripheral Touch Controller.....</b>	<b>797</b>
40.1. Overview.....	797
40.2. Features.....	797
40.3. Block Diagram.....	798
40.4. Signal Description.....	798

40.5. Product Dependencies.....	798
40.6. Functional Description.....	800
<b>41. FREQM – Frequency Meter.....</b>	<b>802</b>
41.1. Overview.....	802
41.2. Features.....	802
41.3. Block Diagram.....	802
41.4. Signal Description.....	802
41.5. Product Dependencies.....	802
41.6. Functional Description.....	804
41.7. Register Summary.....	807
41.8. Register Description.....	807
<b>42. Electrical Characteristics 85°C (SAM C20J/G/E).....</b>	<b>813</b>
42.1. Disclaimer.....	813
42.2. Absolute Maximum Ratings.....	813
42.3. General Operating Ratings.....	813
42.4. Injection Current.....	814
42.5. Supply Characteristics.....	815
42.6. Maximum Clock Frequencies.....	815
42.7. Power Consumption.....	817
42.8. Wake-Up Time.....	818
42.9. I/O Pin Characteristics.....	818
42.10. Analog Characteristics.....	820
42.11. NVM Characteristics.....	830
42.12. Oscillator Characteristics.....	831
42.13. Timing Characteristics.....	838
<b>43. Electrical Characteristics 105°C (SAM C20J/G/E).....</b>	<b>841</b>
43.1. Disclaimer.....	841
43.2. General Operating Ratings.....	841
43.3. Power Consumption.....	841
43.4. Analog Characteristics.....	842
43.5. NVM Characteristics.....	844
43.6. Oscillator Characteristics.....	844
<b>44. Electrical Characteristics 105°C (SAM C20N).....</b>	<b>848</b>
44.1. Disclaimer.....	848
44.2. General Operating Ratings.....	848
44.3. Power Consumption.....	848
44.4. Analog Characteristics.....	849
44.5. NVM Characteristics.....	856
44.6. Oscillator Characteristics.....	857
<b>45. Packaging Information.....</b>	<b>861</b>
45.1. Thermal Considerations.....	861
45.2. Package Drawings.....	862
45.3. Soldering Profile.....	872

46. Schematic Checklist.....	873
46.1. Introduction.....	873
46.2. Operation in Noisy Environment.....	873
46.3. Power Supply.....	873
46.4. External Analog Reference Connections.....	875
46.5. External Reset Circuit.....	876
46.6. Unused or Unconnected Pins.....	877
46.7. Clocks and Crystal Oscillators.....	878
46.8. Programming and Debug Ports.....	880
47. Errata.....	885
47.1. SAM C20E/G/J.....	885
47.2. SAM C20N.....	900
48. Revision History.....	905
48.1. Rev - 03/2017.....	905
48.2. Rev J - 11/2016.....	905
48.3. Rev I - 09/2016.....	906
48.4. Rev H - 05/2016.....	907
48.5. Rev G - 04/2015.....	908
48.6. Rev F - 02/2015.....	909
48.7. Rev E - 12/2015.....	910
48.8. Rev D - 09/2015.....	911
48.9. Rev C - 09/2015.....	911
48.10. Rev B - 06/2015.....	911
48.11. Rev A - 04/2015.....	911
The Microchip Web Site.....	912
Customer Change Notification Service.....	912
Customer Support.....	912
Product Identification System.....	913
Microchip Devices Code Protection Feature.....	913
Legal Notice.....	914
Trademarks.....	914
Quality Management System Certified by DNV.....	914
Worldwide Sales and Service.....	916

## 1. Description

The SAM C20 devices provide the following features: In-system programmable Flash, twelve-channel direct memory access (DMA) controller, twelve-channel Event System, programmable interrupt controller, up to 84 programmable I/O pins, 32-bit real-time clock and calendar, up to eight 16-bit Timer/Counters (TC) and three Timer/Counters for Control (TCC), where each TC can be configured to perform frequency and waveform generation, accurate program execution timing or input capture with time and frequency measurement of digital signals. The TCs can operate in 8- or 16-bit mode, selected TCs can be cascaded to form a 32-bit TC, and three timer/counters have extended functions optimized for motor, lighting and other control applications. Two TCC can operate in 24-bit mode, and the third TCC can operate in 16-bit mode. The series provide up to eight Serial Communication Modules (SERCOM) that each can be configured to act as an USART, UART, SPI, I<sup>2</sup>C up to 3.4MHz, SMBus, PMBus, RS-485 and LIN master/slave; one 12-bit, 1Msps ADC with up to 12-channels, four analog comparators with window mode, Peripheral Touch Controller supporting up to 256 channels for buttons, sliders, wheels and proximity sensing; programmable Watchdog Timer, brown-out detector and power-on reset and two-pin Serial Wire Debug (SWD) program and debug interface.

All devices have accurate and low-power external and internal oscillators. All oscillators can be used as a source for the system clock. Different clock domains can be independently configured to run at different frequencies, enabling power saving by running each peripheral at its optimal clock frequency, and thus maintaining a high CPU frequency while reducing power consumption.

The SAM C20 devices have two software-selectable sleep modes, idle and standby. In idle mode the CPU is stopped while all other functions can be kept running. In standby all clocks and functions are stopped except those selected to continue running. In this mode all RAMs and logic contents are retained. The device supports SleepWalking. This feature allows the peripheral to wake up from sleep based on predefined conditions, and thus allows some internal operation like DMA transfer and/or the CPU to wake up only when needed, e.g. when a threshold is crossed or a result is ready. The Event System supports synchronous and asynchronous events, allowing peripherals to receive, react to and send events even in standby mode.

The Flash program memory can be reprogrammed in-system through the SWD interface. The same interface can be used for non-intrusive on-chip debug of application code. A boot loader running in the device can use any communication interface to download and upgrade the application program in the Flash memory.

The SAM C20 devices are supported with a full suite of program and system development tools, including C compilers, macro assemblers, program debugger/simulators, programmers and evaluation kits.

## 2. Configuration Summary

	SAM C20N	SAM C20J	SAM C20G	SAM C20E
Pins	100	64 (56 for WLCSP)	48	32
General Purpose I/O-pins (GPIOs)	84	52	38	26
Flash	256/128KB	256/128/64/32KB	256/128/61/32KB	256/128/64/32KB
Flash RWW section	8/4KB	8/4/2/1KB	8/4/2/1KB	8/4/2/1KB
System SRAM	32/16KB	32/16/8/4KB	32/16/8/4KB	32/16/8/4KB
Timer Counter (TC) instances	8	5	5	5
Waveform output channels per TC instance	2	2	2	2
TC Maximum and Minimum Capture	Yes	No	No	No
Timer Counter for Control (TCC) instances	3	3	3	3
Waveform output channels per TCC	8/4/2	8/4/2	8/4/2	6/4/2
DMA channels	12	6	6	6
Configurable Custom Logic (CCL) (LUTs)	4	4	4	4
Serial Communication Interface (SERCOM) instances	8	4	4	4
Divide and Square Root Accelerator (DIVAS)	Yes	Yes	Yes	Yes
Analog-to-Digital Converter (ADC) channels	12	12	12	10
Analog Comparators (AC)	4	2	2	2
Real-Time Counter (RTC)	Yes	Yes	Yes	Yes
RTC alarms	1	1	1	1
RTC compare values	One 32-bit value or two 16-bit values	One 32-bit value or two 16-bit values	One 32-bit value or two 16-bit values	One 32-bit value or two 16-bit values
External Interrupt lines	16 with HW debouncing	16	16	16
Peripheral Touch Controller (PTC)	32	32	22	16

# SAM C20 Family

	SAM C20N	SAM C20J	SAM C20G	SAM C20E
Number of self-capacitance channels (Y-lines)				
Peripheral Touch Controller (PTC)	256 (16x16)	256 (16x16)	121 (11x11)	64 (8x8)
Number of mutual-capacitance channels (X x Y lines)				
Frequency Meter (FREQM) reference clock divider	Yes	Yes	Yes	Yes
Maximum CPU frequency	48MHz			
Packages	TQFP	QFN TQFP WLCSP	QFN TQFP	QFN TQFP
Oscillators	32.768kHz crystal oscillator (XOSC32K) 0.4-32MHz crystal oscillator (XOSC) 32.768kHz internal oscillator (OSC32K) 32KHz ultra-low-power internal oscillator (OSCULP32K) 48MHz high-accuracy internal oscillator (OSC48M) 96MHz Fractional Digital Phased Locked Loop (FDPLL96M)			
Event System channels	6	6	6	6
SW Debug Interface	Yes	Yes	Yes	Yes
Watchdog Timer (WDT)	Yes	Yes	Yes	Yes

## Related Links

[I/O Multiplexing and Considerations](#)

## 3. Ordering Information



### 3.1 SAM C20E

Table 3-1. SAM C20E15A Ordering Codes

Ordering Code	FLASH (bytes)	SRAM (bytes)	Package	Carrier Type	Temp
ATSAMC20E15A-AUT	32K	4K	TQFP32	Tape & Reel	85°C
ATSAMC20E15A-ANT	32K	4K	TQFP32	Tape & Reel	105°C
ATSAMC20E15A-MUT	32K	4K	QFN32	Tape & Reel	85°C
ATSAMC20E15A-MNT	32K	4K	QFN32	Tape & Reel	105°C

Table 3-2. SAM C20E16A Ordering Codes

Ordering Code	FLASH (bytes)	SRAM (bytes)	Package	Carrier Type	Temp
ATSAMC20E16A-AUT	64K	8K	TQFP32	Tape & Reel	85°C
ATSAMC20E16A-ANT	64K	8K	TQFP32	Tape & Reel	105°C
ATSAMC20E16A-MUT	64K	8K	QFN32	Tape & Reel	85°C
ATSAMC20E16A-MNT	64K	8K	QFN32	Tape & Reel	105°C



**Table 3-3. SAM C20E17A Ordering Codes**

Ordering Code	FLASH (bytes)	SRAM (bytes)	Package	Carrier Type	Temp
ATSAMC20E17A-AUT	128K	16K	TQFP32	Tape & Reel	85°C
ATSAMC20E17A-ANT	128K	16K	TQFP32	Tape & Reel	105°C
ATSAMC20E17A-MUT	128K	16K	QFN32	Tape & Reel	85°C
ATSAMC20E17A-MNT	128K	16K	QFN32	Tape & Reel	105°C

**Table 3-4. SAM C20E18A Ordering Codes**

Ordering Code	FLASH (bytes)	SRAM (bytes)	Package	Carrier Type	Temp
ATSAMC20E18A-AUT	256K	32K	TQFP32	Tape & Reel	85°C
ATSAMC20E18A-ANT	256K	32K	TQFP32	Tape & Reel	105°C
ATSAMC20E18A-MUT	256K	32K	QFN32	Tape & Reel	85°C
ATSAMC20E18A-MNT	256K	32K	QFN32	Tape & Reel	105°C

## 3.2 SAM C20G

**Table 3-5. SAM C20G15A Ordering Codes**

Ordering Code	FLASH (bytes)	SRAM (bytes)	Package	Carrier Type	Temp
ATSAM C20G15A-AUT	32K	4K	TQFP48	Tape & Reel	85°C
ATSAM C20G15A-ANT	32K	4K	TQFP48	Tape & Reel	105°C
ATSAM C20G15A-MUT	32K	4K	QFN48	Tape & Reel	85°C
ATSAM C20G15A-MNT	32K	4K	QFN48	Tape & Reel	105°C

**Table 3-6. SAM C20G16A Ordering Codes**

Ordering Code	FLASH (bytes)	SRAM (bytes)	Package	Carrier Type	Temp
ATSAMC20G16A-AUT	64K	8K	TQFP48	Tape & Reel	85°C
ATSAMC20G16A-ANT	64K	8K	TQFP48	Tape & Reel	105°C
ATSAMC20G16A-MUT	64K	8K	QFN48	Tape & Reel	85°C
ATSAMC20G16A-MNT	64K	8K	QFN48	Tape & Reel	105°C

**Table 3-7. SAM C20G17A Ordering Codes**

Ordering Code	FLASH (bytes)	SRAM (bytes)	Package	Carrier Type	Temp
ATSAMC20G17A-AUT	128K	16K	TQFP48	Tape & Reel	85°C
ATSAMC20G17A-ANT	128K	16K	TQFP48	Tape & Reel	105°C
ATSAMC20G17A-MUT	128K	16K	QFN48	Tape & Reel	85°C
ATSAMC20G17A-MNT	128K	16K	QFN48	Tape & Reel	105°C

**Table 3-8. SAM C20G18A Ordering Codes**

Ordering Code	FLASH (bytes)	SRAM (bytes)	Package	Carrier Type	Temp
ATSAMC20G18A-AUT	256K	32K	TQFP48	Tape & Reel	85°C
ATSAMC20G18A-ANT	256K	32K	TQFP48	Tape & Reel	105°C
ATSAMC20G18A-MUT	256K	32K	QFN48	Tape & Reel	85°C
ATSAMC20G18A-MNT	256K	32K	QFN48	Tape & Reel	105°C

## 3.3 SAM C20J

**Table 3-9. SAM C20J15A Ordering Codes**

Ordering Code	FLASH (bytes)	SRAM (bytes)	Package	Carrier Type	Temp
ATSAMC20J15A-AUT	32K	4K	TQFP64	Tape & Reel	85°C
ATSAMC20J15A-ANT	32K	4K	TQFP64	Tape & Reel	105°C
ATSAMC20J15A-MUT	32K	4K	QFN64	Tape & Reel	85°C
ATSAMC20J15A-MNT	32K	4K	QFN64	Tape & Reel	105°C

**Table 3-10. SAM C20J16A Ordering Codes**

Ordering Code	FLASH (bytes)	SRAM (bytes)	Package	Carrier Type	Temp
ATSAMC20J16A-AUT	64K	8K	TQFP64	Tape & Reel	85°C
ATSAMC20J16A-ANT	64K	8K	TQFP64	Tape & Reel	105°C
ATSAMC20J16A-MUT	64K	8K	QFN64	Tape & Reel	85°C
ATSAMC20J16A-MNT	64K	8K	QFN64	Tape & Reel	105°C

**Table 3-11. SAM C20J17A Ordering Codes**

Ordering Code	FLASH (bytes)	SRAM (bytes)	Package	Carrier Type	Temp
ATSAMC20J17A-AUT	128K	16K	TQFP64	Tape & Reel	85°C
ATSAMC20J17A-ANT	128K	16K	TQFP64	Tape & Reel	105°C
ATSAMC20J17A-MUT	128K	16K	QFN64	Tape & Reel	85°C
ATSAMC20J17A-MNT	128K	16K	QFN64	Tape & Reel	105°C
ATSAMC20J17A-UUT <sup>(1)</sup>	128K	16K	WLCSP56	Tape & Reel	85°C

1. Contact your local Microchip sales representative for availability.

**Table 3-12. SAM C20J18A Ordering Codes**

Ordering Code	FLASH (bytes)	SRAM (bytes)	Package	Carrier Type	Temp
ATSAMC20J18A-AUT	256K	32K	TQFP64	Tape & Reel	85°C
ATSAMC20J18A-ANT	256K	32K	TQFP64	Tape & Reel	105°C
ATSAMC20J18A-MUT	256K	32K	QFN64	Tape & Reel	85°C
ATSAMC20J18A-MNT	256K	32K	QFN64	Tape & Reel	105°C
ATSAMC20J18A-UUT <sup>(1)</sup>	256K	32K	WLCSP56	Tape & Reel	85°C

1. Contact your local Microchip sales representative for availability.

## 3.4 SAM C20N

**Table 3-13. SAM C20N17A Ordering Codes**

Ordering Code	FLASH (bytes)	SRAM (bytes)	Package	Carrier Type	Temp
ATSAMC20N17A-ANT	128K	16K	TQFP100	Tape & Reel	105°C

**Table 3-14. SAM C20N18A Ordering Codes**

Ordering Code	FLASH (bytes)	SRAM (bytes)	Package	Carrier Type	Temp
ATSAMC20N18A-ANT	256K	32K	TQFP100	Tape & Reel	105°C

## 3.5 Device Identification

The DSU - Device Service Unit peripheral provides the Device Selection bits in the Device Identification register (DID.DEVSEL) in order to identify the device by software. The SAM C20 variants have a reset value of DID=0x1101drxx, with the LSB identifying the die number ('d'), the die revision ('r') and the device selection ('xx').

**Table 3-15. SAM C20 Device Identification Values**

DEVSEL (DID[7:0])	Device
0x00	SAM C20J18A
0x01	SAM C20J17A
0x02	SAM C20J16A
0x03	SAM C20J15A
0x04	Reserved
0x05	SAM C20G18A
0x06	SAM C20G17A
0x07	SAM C20G16A
0x08	SAM C20G15A
0x09	Reserved
0x0A	SAM C20E18A
0x0B	SAM C20E17A
0x0C	SAM C20E16A
0x0D	SAM C20E15A
0x0E - 0x1F	Reserved
0x20	SAM C20N18A
0x21	SAM C20N17A
0x22-0xFF	Reserved

**Note:** The device variant (last letter of the ordering number) is independent of the die revision (DSU.DID.REVISION): The device variant denotes functional differences, whereas the die revision marks evolution of the die.

**Related Links**

[DSU - Device Service Unit](#)

[DID](#)

## 4. Block Diagram

Figure 4-1. System Block Diagram for SAM C20N



**Figure 4-2. System Block Diagram for SAM C20E/G/J**



**Note:**

1. Some products have different number of SERCOM instances, Timer/Counter instances, PTC signals and ADC signals.
2. The three TCC instances have different configurations, including the number of Waveform Output (WO) lines.

**Related Links**

[TCC Configurations](#)

[Multiplexed Signals](#)

## 5. Pinout

### 5.1 SAM C20E

#### 5.1.1 QFN32 / TQFP32





## 5.2 SAM C20G

### 5.2.1 QFN48 / TQFP48



## 5.3 SAM C20J

### 5.3.1 QFN64 / TQFP64



## 5.3.2 WLCSP56



- DIGITAL PIN
- ANALOG PIN
- OSCILLATOR
- GROUND
- INPUT SUPPLY
- REGULATED OUTPUT SUPPLY
- RESET PIN

## 5.4 SAM C20N

### 5.4.1 TQFP100



## 6. Signal Descriptions List

The following table gives details on signal names classified by peripheral.

**Table 6-1. Signal Descriptions List**

Signal Name	Function	Type	Active Level
<b>Analog Comparators - AC</b>			
AIN[7:0]	AC Analog Inputs	Analog	
CMP[2:0]	AC Comparator Outputs	Digital	
<b>Analog Digital Converter - ADCx</b>			
AIN[11:0]	ADC Analog Inputs	Analog	
VREFA	ADC Voltage External Reference A	Analog	
<b>External Interrupt Controller - EIC</b>			
EXTINT[15:0]	External Interrupts inputs	Digital	
NMI	External Non-Maskable Interrupt input	Digital	
<b>Generic Clock Generator - GCLK</b>			
GCLK_IO[7:0]	Generic Clock (source clock inputs or generic clock generator output)	Digital	
<b>Custom Control Logic - CCL</b>			
IN[11:0]	Logic Inputs	Digital	
OUT[3:0]	Logic Outputs	Digital	
<b>Power Manager - PM</b>			
RESETN	Reset input	Digital	Low
<b>Serial Communication Interface - SERCOMx</b>			
PAD[3:0]	SERCOM Inputs/Outputs Pads	Digital	
<b>Oscillators Control - OSCCTRL</b>			
XIN	Crystal or external clock Input	Analog/Digital	
XOUT	Crystal Output	Analog	
<b>32KHz Oscillators Control - OSC32KCTRL</b>			
XIN32	32KHz Crystal or external clock Input	Analog/Digital	
XOUT32	32KHz Crystal Output	Analog	
<b>Timer Counter - TCx</b>			
WO[1:0]	Waveform Outputs	Digital	
<b>Timer Counter - TCCx</b>			
WO[1:0]	Waveform Outputs	Digital	
<b>Peripheral Touch Controller - PTC</b>			
X[15:0]	PTC Input	Analog	
Y[15:0]	PTC Input	Analog	
<b>General Purpose I/O - PORT</b>			
PA25 - PA00	Parallel I/O Controller I/O Port A	Digital	

Signal Name	Function	Type	Active Level
PA28 - PA27	Parallel I/O Controller I/O Port A	Digital	
PA31 - PA30	Parallel I/O Controller I/O Port A	Digital	
PB17 - PB00	Parallel I/O Controller I/O Port B	Digital	
PB21 - PB19	Parallel I/O Controller I/O Port B	Digital	
PB25 - PB22	Parallel I/O Controller I/O Port B	Digital	
PB31 - PB30	Parallel I/O Controller I/O Port B	Digital	
PC03 - PC-00	Parallel I/O Controller I/O Port C	Digital	
PC21 - PC05	Parallel I/O Controller I/O Port C	Digital	
PC28 - PC24	Parallel I/O Controller I/O Port C	Digital	

## 7. I/O Multiplexing and Considerations

### 7.1 Multiplexed Signals

Each pin is by default controlled by the PORT as a general purpose I/O and alternatively it can be assigned to one of the peripheral functions A, B, C, D, E, F, G, H or I. To enable a peripheral function on a pin, the Peripheral Multiplexer Enable bit in the Pin Configuration register corresponding to that pin (PINCFGn.PMUXEN, n = 0-31) in the PORT must be written to one. The selection of peripheral function A to H is done by writing to the Peripheral Multiplexing Odd and Even bits in the Peripheral Multiplexing register (PMUXn.PMUXE/O) in the PORT.

**Table 7-1. PORT Function Multiplexing for SAM C20N**

Pin	I/O Pin	Supply	A			B			C			D		E		F		G		H		I	
			EIC	REF	ADC	AC	PTC	SERCOM	SERCOM-ALT	TC	TCC	COM	AC/GCLK	CCL									
1	PA00	VDDANA	EXTINT[0]								SERCOM1/PAD[0]	TC2/WO[0]								CMP[2]			
2	PA01	VDDANA	EXTINT[1]								SERCOM1/PAD[1]	TC2/WO[1]								CMP[3]			
3	PC00	VDDANA	EXTINT[8]			AIN[8]																	
4	PC01	VDDANA	EXTINT[9]			AIN[9]																	
5	PC02	VDDANA	EXTINT[10]			AIN[10]																	
6	PC03	VDDIO	EXTINT[11]			AIN[11]				SERCOM7/PAD[0]					TCC2/WO[0]								
7	PA02	VDDANA	EXTINT[2]			AIN[0]	AIN[4]	Y[0]															
8	PA03	VDDANA	EXTINT[3]	ADC/VREFA		AIN[1]		Y[1]															
9	PB04	VDDANA	EXTINT[4]				AIN[5]	Y[10]															
10	PB05	VDDANA	EXTINT[5]				AIN[6]	Y[11]															
13	PB06	VDDIO	EXTINT[6]				AIN[7]	Y[12]		SERCOM7/PAD[1]												CCL2/IN[6]	
14	PB07	VDDIO	EXTINT[7]					Y[13]		SERCOM7/PAD[3]	SERCOM7/PAD[2]											CCL2/IN[7]	
15	PB08	VDDIO	EXTINT[8]			AIN[2]		Y[14]		SERCOM7/PAD[2]	SERCOM7/PAD[3]	TC4/WO[0]										CCL2/IN[8]	
16	PB09	VDDANA	EXTINT[9]			AIN[3]		Y[15]			SERCOM4/PAD[1]	TC4/WO[1]										CCL2/OUT[2]	
17	PA04	VDDANA	EXTINT[4]			AIN[4]	AIN[0]	Y[2]			SERCOM0/PAD[0]	TC0/WO[0]										CCL0/IN[0]	
18	PA05	VDDANA	EXTINT[5]			AIN[5]	AIN[1]	Y[3]			SERCOM0/PAD[1]	TC0/WO[1]										CCL0/IN[1]	
19	PA06	VDDANA	EXTINT[6]			AIN[6]	AIN[2]	Y[4]			SERCOM0/PAD[2]	TC1/WO[0]										CCL0/IN[2]	
20	PA07	VDDANA	EXTINT[7]			AIN[7]	AIN[3]	Y[5]			SERCOM0/PAD[3]	TC1/WO[1]										CCL0/OUT[0]	
21	PC05	VDDANA	EXTINT[13]							SERCOM6/PAD[3]					TCC2/WO[1]								
22	PC06	VDDANA	EXTINT[14]							SERCOM6/PAD[0]													
23	PC07	VDDANA	EXTINT[15]							SERCOM6/PAD[1]													
26	PA08	VDDIO	NMI					X[0]/Y[16]		SERCOM0/PAD[0]	SERCOM2/PAD[0]	TC0/WO[0]	TCC0/WO[0]									CCL1/IN[3]	
27	PA09	VDDIO	EXTINT[9]					X[1]/Y[17]		SERCOM0/PAD[1]	SERCOM2/PAD[1]	TC0/WO[1]	TCC0/WO[1]									CCL1/IN[4]	
28	PA10	VDDIO	EXTINT[10]					X[2]/Y[18]		SERCOM0/PAD[2]	SERCOM2/PAD[2]	TC1/WO[0]	TCC0/WO[2]					GCLK_I0[4]				CCL1/IN[5]	
29	PA11	VDDIO	EXTINT[11]					X[3]/Y[19]		SERCOM0/PAD[3]	SERCOM2/PAD[3]	TC1/WO[1]	TCC0/WO[3]					GCLK_I0[5]				CCL1/OUT[1]	
30	PB10	VDDIO	EXTINT[10]								SERCOM4/PAD[2]	TC5/WO[0]	TCC0_WO4						GCLK_I0[4]			CCL1/IN[5]	
31	PB11	VDDIO	EXTINT[11]								SERCOM4/PAD[3]	TC5/WO[1]	TCC0_WO5						GCLK_I0[5]			CCL1/OUT[1]	
32	PB12	VDDIO	EXTINT[12]					X[12]/Y[28]		SERCOM4/PAD[0]		TC4/WO[0]	TCC0_WO6						GCLK_I0[6]				
33	PB13	VDDIO	EXTINT[13]					X[13]/Y[29]		SERCOM4/PAD[1]		TC4/WO[1]	TCC0_WO7						GCLK_I0[7]				
34	PB14	VDDIO	EXTINT[14]					X[14]/Y[30]		SERCOM4/PAD[2]		TC5/WO[0]							GCLK_I0[0]			CCL3/IN[9]	
35	PB15	VDDIO	EXTINT[15]					X[15]/Y[31]		SERCOM4/PAD[3]		TC5/WO[1]							GCLK_I0[1]			CCL3/IN[10]	
38	PC08	VDDIO	EXTINT[0]							SERCOM6/PAD[0]	SERCOM7/PAD[0]												
39	PC09	VDDIO	EXTINT[1]							SERCOM6/PAD[1]	SERCOM7/PAD[1]												
40	PC10	VDDIO	EXTINT[2]							SERCOM6/PAD[2]	SERCOM7/PAD[2]												
41	PC11	VDDIO	EXTINT[3]							SERCOM6/PAD[3]	SERCOM7/PAD[3]												
42	PC12	VDDIO	EXTINT[4]							SERCOM7/PAD[0]													
43	PC13	VDDIO	EXTINT[5]							SERCOM7/PAD[1]													
44	PC14	VDDIO	EXTINT[6]							SERCOM7/PAD[2]													
45	PC15	VDDIO	EXTINT[7]							SERCOM7/PAD[3]													
46	PA12	VDDIO	EXTINT[12]							SERCOM2/PAD[0]	SERCOM4/PAD[0]	TC2/WO[0]	TCC0_WO6							CMP[0]			
47	PA13	VDDIO	EXTINT[13]							SERCOM2/PAD[1]	SERCOM4/PAD[1]	TC2/WO[1]	TCC0_WO7							CMP[1]			
48	PA14	VDDIO	EXTINT[14]							SERCOM2/PAD[2]	SERCOM4/PAD[2]	TC3/WO[0]							GCLK_I0[0]				
49	PA15	VDDIO	EXTINT[15]							SERCOM2/PAD[3]	SERCOM4/PAD[3]	TC3/WO[1]							GCLK_I0[1]				
52	PA16	VDDIO	EXTINT[0]					X[4]/Y[20]		SERCOM1/PAD[0]	SERCOM3/PAD[0]	TC2/WO[0]	TCC1/WO[0]						GCLK_I0[2]			CCL0/IN[0]	
53	PA17	VDDIO	EXTINT[1]					X[5]/Y[21]		SERCOM1/PAD[1]	SERCOM3/PAD[1]	TC2/WO[1]	TCC1/WO[1]						GCLK_I0[3]			CCL0/IN[1]	
54	PA18	VDDIO	EXTINT[2]					X[6]/Y[22]		SERCOM1/PAD[2]	SERCOM3/PAD[2]	TC3/WO[0]	TCC1/WO[2]						CMP[0]			CCL0/IN[2]	
55	PA19	VDDIO	EXTINT[3]					X[7]/Y[23]		SERCOM1/PAD[3]	SERCOM3/PAD[3]	TC3/WO[1]	TCC1/WO[3]						CMP[1]			CCL0/OUT[0]	
56	PC16	VDDIO	EXTINT[8]							SERCOM6/PAD[0]													
57	PC17	VDDIO	EXTINT[9]							SERCOM6/PAD[1]													
58	PC18	VDDIO	EXTINT[10]							SERCOM6/PAD[2]													
59	PC19	VDDIO	EXTINT[11]							SERCOM6/PAD[3]													

Pin	I/O Pin	Supply	A	REF	B	B <sup>(1)(2)</sup>	PTC	C	D	E	F	G	H	I
			EIC		ADC0	AC		SERCOM	SERCOM-ALT	TC	TCC	COM	AC/GCLK	CCL
60	PC20	VDDIO	EXTINT[12]											CCL3/IN[9]
61	PC21	VDDIO	EXTINT[13]											CCL3/IN[10]
64	PB16	VDDIO	EXTINT[0]					SERCOM5/PAD[0]		TC6/WO[0]			GCLK_I0[2]	CCL3/IN[11]
65	PB17	VDDIO	EXTINT[1]					SERCOM5/PAD[1]		TC6/WO[1]			GCLK_I0[3]	CCL3/OUT[3]
66	PB18	VDDIO	EXTINT[2]					SERCOM5/PAD[2]	SERCOM3/PAD[2]				GCLK_I0[4]	
67	PB19	VDDIO	EXTINT[3]					SERCOM5/PAD[3]	SERCOM3/PAD[3]				GCLK_I0[5]	
68	PB20	VDDIO	EXTINT[4]					SERCOM3/PAD[0]	SERCOM2/PAD[0]				GCLK_I0[6]	
69	PB21	VDDIO	EXTINT[5]					SERCOM3/PAD[1]	SERCOM2/PAD[1]				GCLK_I0[7]	
70	PA20	VDDIO	EXTINT[4]				X[8]/Y[24]	SERCOM5/PAD[2]	SERCOM3/PAD[2]	TC7/WO[0]	TCC2/WO[0]		GCLK_I0[4]	
71	PA21	VDDIO	EXTINT[5]				X[9]/Y[25]	SERCOM5/PAD[3]	SERCOM3/PAD[3]	TC7/WO[1]	TCC2/WO[1]		GCLK_I0[5]	
72	PA22	VDDIO	EXTINT[6]				X[10]/Y[26]	SERCOM3/PAD[0]	SERCOM5/PAD[0]	TC4/WO[0]	TCC1/WO[0]		GCLK_I0[6]	CCL2/IN[6]
73	PA23	VDDIO	EXTINT[7]				X[11]/Y[27]	SERCOM3/PAD[1]	SERCOM5/PAD[1]	TC4/WO[1]	TCC1/WO[1]		GCLK_I0[7]	CCL2/IN[7]
74	PA24	VDDIO	EXTINT[12]					SERCOM3/PAD[2]	SERCOM5/PAD[2]	TC5/WO[0]	TCC2/WO[0]		CMP[2]	CCL2/IN[8]
75	PA25	VDDIO	EXTINT[13]					SERCOM3/PAD[3]	SERCOM5/PAD[3]	TC5/WO[1]	TCC2/WO[1]		CMP[3]	CCL2/OUT[2]
78	PB22	VDDIO	EXTINT[6]					SERCOM0/PAD[2]	SERCOM5/PAD[2]	TC7/WO[0]	TCC1/WO[2]		GCLK_I0[0]	CCL0/IN[0]
79	PB23	VDDIO	EXTINT[7]					SERCOM0/PAD[3]	SERCOM5/PAD[3]	TC7/WO[1]	TCC1/WO[3]		GCLK_I0[1]	CCL0/OUT[0]
80	PB24	VDDIO	EXTINT[8]					SERCOM0/PAD[0]	SERCOM4/PAD[0]				CMP[0]	
81	PB25	VDDIO	EXTINT[9]					SERCOM0/PAD[1]	SERCOM4/PAD[1]				CMP[1]	
82	PC24	VDDIO	EXTINT[0]					SERCOM0/PAD[2]	SERCOM4/PAD[2]					
83	PC25	VDDIO	EXTINT[1]					SERCOM0/PAD[3]	SERCOM4/PAD[3]					
84	PC26	VDDIO	EXTINT[2]											
85	PC27	VDDIO	EXTINT[3]						SERCOM1/PAD[0]					CCL1/IN[4]
86	PC28	VDDIO	EXTINT[4]						SERCOM1/PAD[1]					CCL1/IN[5]
87	PA27	VDDIN	EXTINT[15]										GCLK_I0[0]	
89	PA28	VDDIN	EXTINT[8]										GCLK_I0[0]	
93	PA30	VDDIN	EXTINT[10]						SERCOM1/PAD[2]	TC1/WO[0]		CORTEX_M0P/SWCLK	GCLK_I0[0]	CCL1/IN[3]
94	PA31	VDDIN	EXTINT[11]						SERCOM1/PAD[3]	TC1/WO[1]		CORTEX_M0P/SWDIO		CCL1/OUT[1]
95	PB30	VDDIN	EXTINT[14]					SERCOM1/PAD[0]	SERCOM5/PAD[0]	TC0/WO[0]			CMP[2]	
96	PB31	VDDIN	EXTINT[15]					SERCOM1/PAD[1]	SERCOM5/PAD[1]	TC0/WO[1]			CMP[3]	
97	PB00	VDDANA	EXTINT[0]				Y[6]		SERCOM5/PAD[2]	TC7/WO[0]				CCL0/IN[1]
98	PB01	VDDANA	EXTINT[1]				Y[7]		SERCOM5/PAD[3]	TC7/WO[1]				CCL0/IN[2]
99	PB02	VDDANA	EXTINT[2]				Y[8]		SERCOM5/PAD[0]	TC6/WO[0]				CCL0/OUT[0]
100	PB03	VDDANA	EXTINT[3]				Y[9]		SERCOM5/PAD[1]	TC6/WO[1]				

1. All analog pin functions are on peripheral function B. Peripheral function B must be selected to disable the digital control of the pin.
2. Only some pins can be used in SERCOM I2C mode. Refer to [SERCOM I2C Pins](#).

**Table 7-2. PORT Function Multiplexing for SAM C20E,G,J**

SAM C20E	Pin <sup>(1)</sup>	SAM C20G	SAM C20J	I/O Pin	Supply	A	REF	ADC0	AC	PTC	C	D	E	F	G	H	I
						EIC					SERCOM <sup>(2)(3)(4)</sup>	SERCOM-ALT <sup>(4)</sup>	TC	TCC	COM	AC/GCLK	CCL
1	1	1	1	PA00	VDDANA	EXTINT[0]							SERCOM1/PAD[0]	TCC2/WO[0]			CMP[2]
2	2	2	2	PA01	VDDANA	EXTINT[1]							SERCOM1/PAD[1]	TCC2/WO[1]			CMP[3]
3	3	3	3	PA02	VDDANA	EXTINT[2]		AIN[0]	AIN[4]	Y[0]							
4	4	4	4	PA03	VDDANA	EXTINT[3]	ADC/VREFA	AIN[1]	AIN[5]	Y[1]							
			5	PB04	VDDANA	EXTINT[4]				Y[10]							
			6	PB05	VDDANA	EXTINT[5]			AIN[6]	Y[11]							
			9	PB06	VDDANA	EXTINT[6]			AIN[7]	Y[12]							CCL2/IN[6]
			10	PB07	VDDANA	EXTINT[7]				Y[13]							CCL2/IN[7]
			7	11	PB08	VDDANA	EXTINT[8]	AIN[2]		Y[14]		SERCOM4/PAD[0]	TC0/WO[0]				CCL2/IN[8]
			8	12	PB09	VDDANA	EXTINT[9]	AIN[3]		Y[15]		SERCOM4/PAD[1]	TC0/WO[1]				CCL2/OUT[2]
5	9	13	13	PA04	VDDANA	EXTINT[4]		AIN[4]	AIN[0]	Y[2]		SERCOM0/PAD[0]	TCC0/WO[0]				CCL0/IN[0]
6	10	14	14	PA05	VDDANA	EXTINT[5]		AIN[5]	AIN[1]	Y[3]		SERCOM0/PAD[1]	TCC0/WO[1]				CCL0/IN[1]
7	11	15	15	PA06	VDDANA	EXTINT[6]		AIN[6]	AIN[2]	Y[4]		SERCOM0/PAD[2]	TCC1/WO[0]				CCL0/IN[2]
8	12	16	16	PA07	VDDANA	EXTINT[7]		AIN[7]	AIN[3]	Y[5]		SERCOM0/PAD[3]	TCC1/WO[1]				CCL0/OUT[0]
11	13	17	17	PA08	VDDIO	NMI		AIN[8]		X[0]/Y[16]	SERCOM0/PAD[0]	SERCOM2/PAD[0]	TCC0/WO[0]	TCC1/WO[2]			CCL1/IN[3]
12	14	18	18	PA09	VDDIO	EXTINT[9]		AIN[9]		X[1]/Y[17]	SERCOM0/PAD[1]	SERCOM2/PAD[1]	TCC0/WO[1]	TCC1/WO[3]			CCL1/IN[4]



# SAM C20 Family

SAM C20E	Pin <sup>(1)</sup>		I/O Pin	Supply	A	REF	B <sup>(2)(3)</sup>			C	D	E	F	G	H	I
	SAM C20G	SAM C20J					ADC0	AC	PTC							
13	15	19	PA10	VDDIO	EXTINT[10]		AIN[10]		X[2]/Y[18]	SERCOM0/ PAD[2]	SERCOM2/ PAD[2]	TC1/WO[0]	TCC0/ WO[2]		GCLK_IO[4]	CCL1/ IN[5]
14	16	20	PA11	VDDIO	EXTINT[11]		AIN[11]		X[3]/Y[19]	SERCOM0/ PAD[3]	SERCOM2/ PAD[3]	TC1/WO[1]	TCC0/ WO[3]		GCLK_IO[5]	CCL1/ OUT[1]
	19	23	PB10	VDDIO	EXTINT[10]						SERCOM4/ PAD[2]	TC1/WO[0]	TCC0/ WO[4]		GCLK_IO[4]	CCL1/ IN[5]
	20	24	PB11	VDDIO	EXTINT[11]						SERCOM4/ PAD[3]	TC1/WO[1]	TCC0/ WO[5]		GCLK_IO[5]	CCL1/ OUT[1]
		25	PB12	VDDIO	EXTINT[12]				X[12]/Y[28]	SERCOM4/ PAD[0]		TC0/WO[0]	TCC0/ WO[6]		GCLK_IO[6]	
		26	PB13	VDDIO	EXTINT[13]				X[13]/Y[29]	SERCOM4/ PAD[1]		TC0/WO[1]	TCC0/ WO[7]		GCLK_IO[7]	
		27	PB14	VDDIO	EXTINT[14]				X[14]/Y[30]	SERCOM4/ PAD[2]		TC1/WO[0]			GCLK_IO[0]	CCL3/ IN[9]
		28	PB15	VDDIO	EXTINT[15]				X[15]/Y[31]	SERCOM4/ PAD[3]		TC1/WO[1]			GCLK_IO[1]	CCL3/ IN[10]
	21	29	PA12	VDDIO	EXTINT[12]					SERCOM2/ PAD[0]	SERCOM4/ PAD[0]	TCC2/WO[0]	TCC0/ WO[6]		AC/CMP[0]	
	22	30	PA13	VDDIO	EXTINT[13]					SERCOM2/ PAD[1]	SERCOM4/ PAD[1]	TCC2/WO[1]	TCC0/ WO[7]		AC/CMP[1]	
15	23	31	PA14	VDDIO	EXTINT[14]					SERCOM2/ PAD[2]	SERCOM4/ PAD[2]	TC4/WO[0]	TCC0/ WO[4]		GCLK_IO[0]	
16	24	32	PA15	VDDIO	EXTINT[15]					SERCOM2/ PAD[3]	SERCOM4/ PAD[3]	TC4/WO[1]	TCC0/ WO[5]		GCLK_IO[1]	
17	25	35	PA16	VDDIO	EXTINT[0]				X[4]/Y[20]	SERCOM1/ PAD[0]	SERCOM3/ PAD[0]	TCC2/WO[0]	TCC0/ WO[6]		GCLK_IO[2]	CCL0/ IN[0]
18	26	36	PA17	VDDIO	EXTINT[1]				X[5]/Y[21]	SERCOM1/ PAD[1]	SERCOM3/ PAD[1]	TCC2/WO[1]	TCC0/ WO[7]		GCLK_IO[3]	CCL0/ IN[1]
19	27	37	PA18	VDDIO	EXTINT[2]				X[6]/Y[22]	SERCOM1/ PAD[2]	SERCOM3/ PAD[2]	TC4/WO[0]	TCC0/ WO[2]		AC/CMP[0]	CCL0/ IN[2]
20	28	38	PA19	VDDIO	EXTINT[3]				X[7]/Y[23]	SERCOM1/ PAD[3]	SERCOM3/ PAD[3]	TC4/WO[1]	TCC0/ WO[3]		AC/CMP[1]	CCL0/ OUT[0]
		39	PB16	VDDIO	EXTINT[0]					SERCOM5/ PAD[0]		TC2/WO[0]	TCC0/ WO[4]		GCLK_IO[2]	CCL3/ IN[11]
		40	PB17	VDDIO	EXTINT[1]					SERCOM5/ PAD[1]		TC2/WO[1]	TCC0/ WO[5]		GCLK_IO[3]	CCL3/ OUT[3]
	29	41	PA20	VDDIO	EXTINT[4]				X[8]/Y[24]	SERCOM5/ PAD[2]	SERCOM3/ PAD[2]	TC3/WO[0]	TCC0/ WO[6]		GCLK_IO[4]	
	30	42	PA21	VDDIO	EXTINT[5]				X[9]/Y[25]	SERCOM5/ PAD[3]	SERCOM3/ PAD[3]	TC3/WO[1]	TCC0/ WO[7]		GCLK_IO[5]	
21	31	43	PA22	VDDIO	EXTINT[6]				X[10]/Y[26]	SERCOM3/ PAD[0]	SERCOM5/ PAD[0]	TC0/WO[0]	TCC0/ WO[4]		GCLK_IO[6]	CCL2/ IN[6]
22	32	44	PA23	VDDIO	EXTINT[7]				X[11]/Y[27]	SERCOM3/ PAD[1]	SERCOM5/ PAD[1]	TC0/WO[1]	TCC0/ WO[5]		GCLK_IO[7]	CCL2/ IN[7]
23	33	45	PA24	VDDIO	EXTINT[12]					SERCOM3/ PAD[2]	SERCOM5/ PAD[2]	TC1/WO[0]	TCC1/ WO[2]		AC/CMP[2]	CCL2/ IN[8]
24	34	46	PA25	VDDIO	EXTINT[13]					SERCOM3/ PAD[3]	SERCOM5/ PAD[3]	TC1/WO[1]	TCC1/ WO[3]		AC/CMP[3]	CCL2/ OUT[2]
	37	49	PB22	VDDIN	EXTINT[6]						SERCOM5/ PAD[2]	TC3/WO[0]			GCLK_IO[0]	CCL0/ IN[0]
	38	50	PB23	VDDIN	EXTINT[7]						SERCOM5/ PAD[3]	TC3/WO[1]			GCLK_IO[1]	CCL0/ OUT[0]
25	39	51	PA27	VDDIN	EXTINT[15]										GCLK_IO[0]	
27	41	53	PA28	VDDIN	EXTINT[8]										GCLK_IO[0]	
31	45	57	PA30	VDDIN	EXTINT[10]						SERCOM1/ PAD[2]	TC1/WO[0]		CORTEX_M0P/ SWCLK	GCLK_IO[0]	CCL1/ IN[3]
32	46	58	PA31	VDDIN	EXTINT[11]						SERCOM1/ PAD[3]	TC1/WO[1]		CORTEX_M0P/ SWDIO		CCL1/ OUT[1]
		59	PB30	VDDIN	EXTINT[14]						SERCOM5/ PAD[0]	TCC0/WO[0]	TCC1/ WO[2]		AC/CMP[2]	
		60	PB31	VDDIN	EXTINT[15]						SERCOM5/ PAD[1]	TCC0/WO[1]	TCC1/ WO[3]		AC/CMP[3]	
		61	PB00	VDDANA	EXTINT[0]				Y[6]		SERCOM5/ PAD[2]	TC3/WO[0]				CCL0/ IN[1]
		62	PB01	VDDANA	EXTINT[1]				Y[7]		SERCOM5/ PAD[3]	TC3/WO[1]				CCL0/ IN[2]
	47	63	PB02	VDDANA	EXTINT[2]				Y[8]		SERCOM5/ PAD[0]	TC2/WO[0]				CCL0/ OUT[0]
	48	64	PB03	VDDANA	EXTINT[3]				Y[9]		SERCOM5/ PAD[1]	TC2/WO[1]				

1. Use the SAM C21J pinout muxing for the WLCSP56 package.

2. All analog pin functions are on peripheral function B. Peripheral function B must be selected to disable the digital control of the pin.
3. Only some pins can be used in SERCOM I2C mode. Refer to [SERCOM I2C Pins](#).
4. SERCOM4 and SERCOM5 are not supported on SAM C20E

**Related Links**

[SERCOM I2C Pins](#)

## 7.2 Other Functions

### 7.2.1 Oscillator Pinout

The oscillators are not mapped to the normal PORT functions and their multiplexing are controlled by registers in the Oscillators Controller (OSCCTRL) and in the 32K Oscillators Controller (OSC32KCTRL).

**Table 7-3. Oscillator Pinout**

Oscillator	Supply	Signal	I/O pin
XOSC	VDDIO	XIN	PA14
		XOUT	PA15
XOSC32K	VDDANA	XIN32	PA00
		XOUT32	PA01

### 7.2.2 Serial Wire Debug Interface Pinout

Only the SWCLK pin is mapped to the normal PORT functions. A debugger cold-plugging or hot-plugging detection will automatically switch the SWDIO port to the SWDIO function.

**Table 7-4. Serial Wire Debug Interface Pinout**

Signal	Supply	I/O pin
SWCLK	VDDIN	PA30
SWDIO	VDDIN	PA31

### 7.2.3 SERCOM I<sup>2</sup>C Pins

**Table 7-5. SERCOM Pins Supporting I<sup>2</sup>C**

Device	Pins Supporting I <sup>2</sup> C
SAM C20E	PA08, PA09, PA16, PA17, PA22, PA23
SAM C20G	PA08, PA09, PA12, PA13, PA16, PA17, PA22, PA23
SAM C20J	PA08, PA09, PA12, PA13, PA16, PA17, PA22, PA23, PB12, PB13, PB16, PB17, PB30, PB31
SAM C20N	PA08, PA09, PA16, PA17, PB12, PB13, PB16, PB17

## 7.2.4 GPIO Clusters

**Table 7-6. GPIO Clusters**

Package	Cluster	GPIO	Supplies Pin connected to the cluster	
100 pins	1	PB31 PB30 PA31 PA30 PA28 PA27	VDDIN (92)	GND (90)
	2	PC28 PC27 PC26 PC25 PC24 PB25 PB24 PB23 PB22	VDDIO (77)	GND( 76 )
	3	PA25 PA24 PA23 PA22 PA21 PA20 PB21 PB20 PB19 PB18 PB17 PB16	VDDIO(63+77)	GND(62+76)
	4	PC21 PC20 PC19 PC18 PC17 PC16 PA19 PA18 PA17 PA16	VDDIO(51+63)	GND(50+62)
	5	PA15 PA14 PA13 PA12 PC14 PC13 PC12 PC11 PC10 PC09 PC08	VDDIO(36+51)	GND(37+50)
	6	PB15 PB13 PB12 PB11 PB10 PA11 PA10 PA09 PA08	VDDIO(25+36)	GND(24+37)
	7	PC07 PC06 PC05 PA07 PA06 PA05 PA04 PB09 PB05 PB04 PA03 PA02 PC02 PC01 PC00 PA01 PA00 PB03 PB02 PB01 PB00	VDDANA (12)	GNDANA (11)
	8	PC15	VDDIO(25)	GND(37+50)
	9	PB14	VDDIO(25)	GND(24+37)
	10	PB08 PB07 PB06 PC03	VDDIO(25)	GNDANA (11)
64 pins	1	PB31 PB30 PA31 PA30 PA28 PA27	VDDIN (56)	GND (54)
	2	PB23 PB22	VDDIO (48)	GND (54+47)
	3	PA25 PA24 PA23 PA22 PA21 PA20 PB17 PB16 PA19 PA18 PA17 PA16	VDDIO (48+34)	GND (47+33)
	4	PA15 PA14 PA13 PA12 PB15 PB14 PB13 PB12 PB11 PB10	VDDIO (34+21)	GND (33+22)
	5	PA11 PA10 PA08 PA09	VDDIO (21)	GND (22)
	6	PA07 PA06 PA05 PA04 PB09 PB08 PB07 PB06 PB05 PB04 PA03 PA02 PA01 PA00 PB03 PB02 PB01 PB00	VDDANA (8)	GNDANA (7)
48 pins	1	PA31 PA30 PA28 PA27	VDDIN (44)	GND (42)
	2	PB23 PB22	VDDIO (36)	GND (42+35)
	3	PA25 PA24 PA23 PA22 PA21 PA20 PA19 PA18 PA17 PA16 PA15 PA14 PA13 PA12 PB11 PB10	VDDIO (36+17)	GND (35+18)
	4	PA11 PA10 PA08 PA09	VDDIO (17)	GND (18)
	5	PA07 PA06 PA05 PA04 PB09 PB08 PA03 PA02 PA01 PA00 PB03 PB02	VDDANA (6)	GNDANA (5)

Package	Cluster	GPIO	Supplies Pin connected to the cluster	
32 pins	1	PA31 PA30 PA28 PA27	VDDIN (30)	GND (28)
	2	PA25 PA24 PA23 PA22 PA19 PA18 PA17 PA16 PA15 PA14 PA11 PA10 PA08 PA09	VDDIO (9)	GND (28+10)
	3	PA07 PA06 PA05 PA04 PA03 PA02 PA01 PA00	VDDANA (9)	GND (28+10)

## 7.2.5 TCC Configurations

The SAM C20 has three instances of the Timer/Counter for Control applications (TCC) peripheral, , TCC[2:0]. The following table lists the features for each TCC instance.

**Table 7-7. TCC Configuration Summary**

TCC#	Channels (CC_NUM)	Waveform Output (WO_NUM)	Counter size	Fault	Dithering	Output matrix	Dead Time Insertion (DTI)	SWAP	Pattern generation
0	4	8	24-bit	Yes	Yes	Yes	Yes	Yes	Yes
1	2	4	24-bit	Yes	Yes				Yes
2	2	2	16-bit	Yes					

**Note:** The number of CC registers (CC\_NUM) for each TCC corresponds to the number of compare/capture channels, so that a TCC can have more Waveform Outputs (WO\_NUM) than CC registers.

## 8. Power Supply and Start-Up Considerations

### 8.1 Power Domain Overview



## 8.2 Power Supply Considerations

### 8.2.1 Power Supplies

The SAM C20 has several different power supply pins:

- VDDIO: Powers I/O lines and XOSC. Voltage is 2.70V to 5.50V.
- VDDIN: Powers I/O lines and the OSC48M, TOSC and internal regulator. Voltage is 2.70V to 5.50V.
- VDDANA: Powers I/O lines and the ADC, AC, PTC, OSCULP32K, OSC32K and XOSC32K. Voltage is 2.70V to 5.50V.
- VDDCORE: Internal regulated voltage output. Powers the core, memories, peripherals, and FDPLL96M. Voltage is 1.2V typical.

The same voltage must be applied to both VDDIN and VDDANA. This common voltage is referred to as  $V_{DD}$  in the datasheet. VDDIO must always be less than or equal to VDDIN.

The ground pins, GND, are common to VDDCORE, VDDIO and VDDIN. The ground pin for VDDANA is GNDANA.

For decoupling recommendations for the different power supplies, refer to the schematic checklist.

## 8.2.2 Voltage Regulator

The SAM C20 voltage regulator has two different modes:

- Normal mode: This is the default mode when CPU and peripherals are running
- Low Power (LP) mode: This is the default mode used when the chip is in standby mode.

## 8.2.3 Typical Powering Schematics

The SAM C20 uses a single supply from 2.70V to 5.50V or dual supply mode where VDDIO is supplied separately from VDDIN.

The following figures show the recommended power supply connections.

**Figure 8-1. Power Supply Connection for single supply mode only**



## Power Supply Connection for dual supply mode



### 8.2.4 Power-Up Sequence

#### 8.2.4.1 Minimum Rise Rate

The integrated power-on reset (POR) circuitry monitoring the VDDIN power supply requires a minimum rise rate.

#### 8.2.4.2 Maximum Rise Rate

The rise rate of the power supply must not exceed the values described in Electrical Characteristics.

## 8.3 Power-Up

This section summarizes the power-up sequence of the SAM C20. The behavior after power-up is controlled by the Power Manager.

### 8.3.1 Starting of Clocks

After power-up, the device is set to its initial state and kept in reset, until the power has stabilized throughout the device. Once the power has stabilized, the device will use a 4MHz clock. This clock is derived from the 48MHz Internal Oscillator (OSC48M), which is configured to provide a 4MHz clock and used as a clock source for generic clock generator 0. Generic clock generator 0 is the main clock for the Power Manager (PM).

Some synchronous system clocks are active, allowing software execution.

Refer to the “Clock Mask Register” in the Power Manager for the list of default peripheral clocks running. Synchronous system clocks that are running are by default not divided and receive a 4MHz clock through generic clock generator 0. Other generic clocks are disabled.

### 8.3.2 I/O Pins

After power-up, the I/O pins are tri-stated.

### 8.3.3 Fetching of Initial Instructions

After reset has been released, the CPU starts fetching PC and SP values from the reset address, which is 0x00000000. This address points to the first executable address in the internal flash. The code read from the internal flash is free to configure the clock system and clock sources. Refer to the ARM Architecture Reference Manual for more information on CPU startup (<http://www.arm.com>).

## 8.4 Power-On Reset and Brown-Out Detector

The SAM C20 embeds three features to monitor, warn and/or reset the device:

- POR: Power-on reset on VDDIN and VDDIO
- BODVDD: Brown-out detector on VDDIN
- BODCORE: Voltage Regulator Internal Brown-out detector on VDDCORE. The Voltage Regulator Internal BOD is calibrated in production and its calibration configuration is stored in the NVM User Row. This configuration should not be changed if the user row is written to assure the correct behavior of the BODCORE.

### 8.4.1 Power-On Reset on VDDIN

POR monitors VDDIN. It is always activated and monitors voltage at startup and also during all the sleep modes. If VDDIN goes below the threshold voltage, the entire chip is reset.

### 8.4.2 Power-On Reset on VDDIO

POR monitors VDDIO. It is always activated and monitors voltage at startup and also during all the sleep modes. If VDDIO goes below the threshold voltage, all IOs supplied by VDDIO are reset.

### 8.4.3 Brown-Out Detector on VDDIN

BODVDD monitors VDDIN.

### 8.4.4 Brown-Out Detector on VDDCORE

Once the device has started up, BODCORE monitors the internal VDDCORE.



## 9. Product Mapping

Figure 9-1. SAM C20N Product Mapping



**Figure 9-2. SAM C20 E/G/J Product Mapping**



## 10. Memories

### 10.1 Embedded Memories

- Internal high-speed flash with Read-While-Write capability on section of the array
- Internal high-speed RAM, single-cycle access at full speed

### 10.2 Physical Memory Map

The High-Speed bus is implemented as a bus matrix. All High-Speed bus addresses are fixed, and they are never remapped in any way, even during boot. The 32-bit physical address space is mapped as follow:

**Table 10-1. SAM C20 Physical Memory Map<sup>(1)</sup>**

Memory	Start address	Size	Size	Size	Size
		SAM C20x18	SAM C20x17	SAM C20x16	SAM C20x15
Embedded Flash	0x00000000	256Kbytes	128Kbytes	64Kbytes	32Kbytes
Embedded RWW section	0x00400000	8Kbytes	4Kbytes	2Kbytes	1Kbytes
Embedded high-speed SRAM	0x20000000	32Kbytes	16Kbytes	8Kbytes	4Kbytes
AHB-APB Bridge A	0x40000000	64Kbytes	64Kbytes	64Kbytes	64Kbytes
AHB-APB Bridge B	0x41000000	64Kbytes	64Kbytes	64Kbytes	64Kbytes
AHB-APB Bridge C	0x42000000	64Kbytes	64Kbytes	64Kbytes	64Kbytes
AHB-APB Bridge D	0x43000000	64Kbytes	-	-	-
AHB DIVAS	0x48000000	64Kbytes	64Kbytes	64Kbytes	64Kbytes
IOBUS	0x60000000	64Kbytes	64Kbytes	64Kbytes	64Kbytes

Note: 1. x = G, J, E or N. The N-series (100-pin devices) does not include x16 and x15 option.

**Table 10-2. Flash Memory Parameters<sup>(1)</sup>**

Device	Flash size (FLASH_PM)	Number of pages (FLASH_P)	Page size (FLASH_W)
SAM C20x18	256Kbytes	4096	64 bytes
SAM C20x17	128Kbytes	2046	64 bytes
SAM C20x16	64Kbytes	1024	64 bytes
SAM C20x15	32Kbytes	512	64 bytes

Note: 1. x = G, J, E or N. The N-series (100-pin devices) does not include x16 and x15 device.

**Table 10-3. RWW Section Parameters<sup>(1)</sup>**

Device	Flash size (FLASH_PM)	Number of pages (FLASH_P)	Page size (FLASH_W)
SAM C20x18	8Kbytes	128	64 bytes
SAM C20x17	4Kbytes	64	64 bytes
SAM C20x16	2Kbytes	32	64 bytes
SAM C20x15	1Kbytes	16	64 bytes

Note: 1. x = G, J, E or N. The N-series (100-pin devices) does not include x16 and x15 option.

## 10.3 NVM User Row Mapping

The first two 32-bit words of the NVM User Row contains calibration data that are automatically read at device power on.

The NVM User Row can be read at address 0x804000.

To write the NVM User Row, refer to the NVMCTRL - Non-Volatile Memory Controller.

Note that when writing to the user row the values do not get loaded by the other modules on the device until a device reset occurs.

**Table 10-4. NVM User Row Mapping**

Bit Position	Name	Usage	Production setting	Related Peripheral Register
2:0	BOOTPROT	Used to select one of eight different bootloader sizes.	7	NVMCTRL
3	Reserved	-	1	-
6:4	EEPROM	Used to select one of eight different EEPROM sizes.	7	NVMCTRL
7	Reserved	-	1	-
13:8	BODVDD Level	BODVDD Threshold Level at power on.	8	SUPC.BODVDD
14	BODVDD Disable	BODVDD Disable at power on.	0	SUPC.BODVDD
16:15	BODVDD Action	BODVDD Action at power on.	1	SUPC.BODVDD
25:17	Reserved	Voltage Regulator Internal BOD (BODCORE) configuration. These bits are written in production and must not be changed.	0xA8	-
26	WDT Enable	WDT Enable at power on.	0	WDT.CTRLA
27	WDT Always-On	WDT Always-On at power on.	0	WDT.CTRLA
31:28	WDT Period	WDT Period at power on.	0xB	WDT.CONFIG

Bit Position	Name	Usage	Production setting	Related Peripheral Register
35:32	WDT Window	WDT Window mode time-out at power on.	0xB	WDT.CONFIG
39:36	WDT EWOFFSET	WDT Early Warning Interrupt Time Offset at power on.	0xB	WDT.EWCTRL
40	WDT WEN	WDT Timer Window Mode Enable at power on.	0	WDT.CTRLA
41	BODVDD Hysteresis	BODVDD Hysteresis configuration at power on.	0	SUPC.BODVDD
42	Reserved	Voltage Regulator Internal BOD (BODCORE) configuration. These bits are written in production and must not be changed.	0	-
47:43	Reserved	-	0x1F	-
63:48	LOCK	NVM Region Lock Bits.	0xFFFF	NVMCTRL

**Related Links**

[NVMCTRL – Non-Volatile Memory Controller](#)

[CTRLA](#)

[CONFIG](#)

[EWCTRL](#)

[BODVDD](#)

## 10.4 NVM Software Calibration Area Mapping

The NVM Software Calibration Area contains calibration data that are measured and written during production test. These calibration values should be read by the application software and written back to the corresponding register.

The NVM Software Calibration Area can be read at address 0x806020.

The NVM Software Calibration Area can not be written.

**Table 10-5. NVM Software Calibration Area Mapping**

Bit Position	Name	Description
2:0	ADC0 LINEARITY	ADC0 Linearity Calibration. Should be written to the CALIB register.
5:3	ADC0 BIASCAL	ADC0 Bias Calibration. Should be written to the CALIB register.
11:6	Reserved	
18:12	OSC32K CAL	OSC32K Calibration. Should be written to OSC32K register.
40:19	CAL48M 5V	OSC48M Calibration: VDD range 3.6V to 5.5V. Should be written to the CAL48M register.

Bit Position	Name	Description
62:41	CAL48M 3V3	OSC48M Calibration: VDD range 2.7V to 3.6V. Should be written to the CAL48M register.
63	Reserved	

## Related Links

[CAL48M](#)

## 10.5 Serial Number

Each device has a unique 128-bit serial number which is a concatenation of four 32-bit words contained at the following addresses:

Word 0: 0x0080A00C

Word 1: 0x0080A040

Word 2: 0x0080A044

Word 3: 0x0080A048

The uniqueness of the serial number is guaranteed only when using all 128 bits.

## 11. Processor and Architecture

### 11.1 Cortex M0+ Processor

The SAM C20 implements the ARM® Cortex™-M0+ processor, based on the ARMv6 Architecture and Thumb®-2 ISA. The Cortex M0+ is 100% instruction set compatible with its predecessor, the Cortex-M0 core, and upward compatible to Cortex-M3 and M4 cores. The implemented ARM Cortex-M0+ is revision r0p1. For more information refer to <http://www.arm.com>.

#### 11.1.1 Cortex M0+ Configuration

**Table 11-1. Cortex M0+ Configuration**

Features	Cortex-M0+ options	SAM C20 configuration
Interrupts	External interrupts 0-32	32
Data endianness	Little-endian or big-endian	Little-endian
SysTick timer	Present or absent	Present
Number of watchpoint comparators	0, 1, 2	2
Number of breakpoint comparators	0, 1, 2, 3, 4	4
Halting debug support	Present or absent	Present
Multiplier	Fast or small	Fast (single cycle)
Single-cycle I/O port	Present or absent	Present
Wake-up interrupt controller	Supported or not supported	Not supported
Vector Table Offset Register	Present or absent	Present
Unprivileged/Privileged support	Present or absent	Present
Memory Protection Unit	Not present or 8-region	8-region
Reset all registers	Present or absent	Absent
Instruction fetch width	16-bit only or mostly 32-bit	32-bit

The ARM Cortex-M0+ core has two bus interfaces:

- Single 32-bit AMBA-3 AHB-Lite system interface that provides connections to peripherals and all system memory, which includes flash and RAM.
- Single 32-bit I/O port bus interfacing to the PORT and DIVAS with 1-cycle loads and stores.

#### 11.1.2 Cortex-M0+ Peripherals

- System Control Space (SCS)
  - The processor provides debug through registers in the SCS. Refer to the Cortex-M0+ Technical Reference Manual for details (<http://www.arm.com>).
- Nested Vectored Interrupt Controller (NVIC)
  - External interrupt signals connect to the NVIC, and the NVIC prioritizes the interrupts. Software can set the priority of each interrupt. The NVIC and the Cortex-M0+ processor core are closely coupled, providing low latency interrupt processing and efficient processing of late

arriving interrupts. Refer to [Nested Vector Interrupt Controller](#) and the Cortex-M0+ Technical Reference Manual for details (<http://www.arm.com>).

- System Timer (SysTick)
  - The System Timer is a 24-bit timer clocked by CLK\_CPU that extends the functionality of both the processor and the NVIC. Refer to the Cortex-M0+ Technical Reference Manual for details (<http://www.arm.com>).
- System Control Block (SCB)
  - The System Control Block provides system implementation information, and system control. This includes configuration, control, and reporting of the system exceptions. Refer to the Cortex-M0+ Devices Generic User Guide for details (<http://www.arm.com>).
- Micro Trace Buffer (MTB)
  - The CoreSight MTB-M0+ (MTB) provides a simple execution trace capability to the Cortex-M0+ processor. Refer to section [Micro Trace Buffer](#) and the CoreSight MTB-M0+ Technical Reference Manual for details (<http://www.arm.com>).
- Memory Protection Unit (MPU)
  - The Memory Protection Unit divides the memory map into a number of regions, and defines the location, size, access permissions and memory attributes of each region. Refer to the Cortex-M0+ Devices Generic User Guide for details (<http://www.arm.com>).

### 11.1.3 Cortex-M0+ Address Map

**Table 11-2. Cortex-M0+ Address Map**

Address	Peripheral
0xE000E000	System Control Space (SCS)
0xE000E010	System Timer (SysTick)
0xE000E100	Nested Vectored Interrupt Controller (NVIC)
0xE000ED00	System Control Block (SCB)
0x41008000	Micro Trace Buffer (MTB)

#### Related Links

[Product Mapping](#)

### 11.1.4 I/O Interface

#### 11.1.4.1 Overview

Because accesses to the AMBA® AHB-Lite™ and the single cycle I/O interface can be made concurrently, the Cortex-M0+ processor can fetch the next instructions while accessing the I/Os. This enables single cycle I/O accesses to be sustained for as long as needed.

#### 11.1.4.2 Description

Direct access to PORT registers and DIVAS registers.



## 11.2 Nested Vector Interrupt Controller

### 11.2.1 Overview

The Nested Vectored Interrupt Controller (NVIC) in the SAM C20 supports 32 interrupt lines with four different priority levels. For more details, refer to the Cortex-M0+ Technical Reference Manual (<http://www.arm.com>).

### 11.2.2 Interrupt Line Mapping

Each of the interrupt lines is connected to one peripheral instance, as shown in the table below. Each peripheral can have one or more interrupt flags, located in the peripheral's Interrupt Flag Status and Clear (INTFLAG) register.

The interrupt flag is set when the interrupt condition occurs. Each interrupt in the peripheral can be individually enabled by writing a one to the corresponding bit in the peripheral's Interrupt Enable Set (INTENSET) register, and disabled by writing a one to the corresponding bit in the peripheral's Interrupt Enable Clear (INTENCLR) register.

An interrupt request is generated from the peripheral when the interrupt flag is set and the corresponding interrupt is enabled.

The interrupt requests for one peripheral are ORed together on system level, generating one interrupt request for each peripheral. An interrupt request will set the corresponding interrupt pending bit in the NVIC interrupt pending registers (SETPEND/CLRPEND bits in ISPR/ICPR).

For the NVIC to activate the interrupt, it must be enabled in the NVIC interrupt enable register (SETENA/CLRENA bits in ISER/ICER). The NVIC interrupt priority registers IPR0-IPR7 provide a priority field for each interrupt.

**Table 11-3. Interrupt Line Mapping**

Peripheral Source	NVIC Line
EIC NMI – External Interrupt Controller	NMI
PM – Power Manager MCLK - Main Clock OSCCTRL - Oscillators Controller OSC32KCTRL - 32kHz Oscillators Controller SUPC - Supply Controller PAC - Protection Access Controller	0
WDT – Watchdog Timer	1
RTC – Real Time Clock	2
EIC – External Interrupt Controller	3
FREQM – Frequency Meter	4
Reserved	5
NVMCTRL – Non-Volatile Memory Controller	6
DMAC - Direct Memory Access Controller	7

Peripheral Source	NVIC Line
EVSYS – Event System	8
SERCOM0 – Serial Communication Controller 0	9
SERCOM6 – Serial Communication Controller 6	
SERCOM1 – Serial Communication Controller 1	10
SERCOM7 – Serial Communication Controller 7	
SERCOM2 – Serial Communication Controller 2	11
SERCOM3 – Serial Communication Controller 3	12
SERCOM4 – Serial Communication Controller 4	13
SERCOM5 – Serial Communication Controller 5	14
Reserved	15
Reserved	16
TCC0 – Timer Counter for Control 0	17
TCC1 – Timer Counter for Control 1	18
TCC2 – Timer Counter for Control 2	19
TC0 – Timer Counter 0	20
TC5 – Timer Counter 5	
TC1 – Timer Counter 1	21
TC6 – Timer Counter 6	
TC2 – Timer Counter 2	22
TC7 – Timer Counter 7	
TC3 – Timer Counter 3	23
TC4 – Timer Counter 4	24
ADC0 – Analog-to-Digital Converter 0	25
Reserved	26
AC – Analog Comparator	27
Reserved	28
Reserved	29
PTC – Peripheral Touch Controller	30
Reserved	31

## 11.3 Micro Trace Buffer

### 11.3.1 Features

- Program flow tracing for the Cortex-M0+ processor
- MTB SRAM can be used for both trace and general purpose storage by the processor
- The position and size of the trace buffer in SRAM is configurable by software
- CoreSight compliant

### 11.3.2 Overview

When enabled, the MTB records changes in program flow, reported by the Cortex-M0+ processor over the execution trace interface shared between the Cortex-M0+ processor and the CoreSight MTB-M0+. This information is stored as trace packets in the SRAM by the MTB. An off-chip debugger can extract the trace information using the Debug Access Port to read the trace information from the SRAM. The debugger can then reconstruct the program flow from this information.

The MTB simultaneously stores trace information into the SRAM, and gives the processor access to the SRAM. The MTB ensures that trace write accesses have priority over processor accesses.

The execution trace packet consists of a pair of 32-bit words that the MTB generates when it detects the processor PC value changes non-sequentially. A non-sequential PC change can occur during branch instructions or during exception entry. See the CoreSight MTB-M0+ Technical Reference Manual for more details on the MTB execution trace packet format.

Tracing is enabled when the MASTER.EN bit in the Master Trace Control Register is 1. There are various ways to set the bit to 1 to start tracing, or to 0 to stop tracing. See the CoreSight Cortex-M0+ Technical Reference Manual for more details on the Trace start and stop and for a detailed description of the MTB's MASTER register. The MTB can be programmed to stop tracing automatically when the memory fills to a specified watermark level or to start or stop tracing by writing directly to the MASTER.EN bit. If the watermark mechanism is not being used and the trace buffer overflows, then the buffer wraps around overwriting previous trace packets.

The base address of the MTB registers is 0x41008000; this address is also written in the CoreSight ROM Table. The offset of each register from the base address is fixed and as defined by the CoreSight MTB-M0+ Technical Reference Manual. The MTB has 4 programmable registers to control the behavior of the trace features:

- POSITION: Contains the trace write pointer and the wrap bit,
- MASTER: Contains the main trace enable bit and other trace control fields,
- FLOW: Contains the WATERMARK address and the AUTOSTOP and AUTOHALT control bits,
- BASE: Indicates where the SRAM is located in the processor memory map. This register is provided to enable auto discovery of the MTB SRAM location, by a debug agent.

See the CoreSight MTB-M0+ Technical Reference Manual for a detailed description of these registers.

## 11.4 High-Speed Bus System

### 11.4.1 Features

High-Speed Bus Matrix has the following features:

- Symmetric crossbar bus switch implementation
- Allows concurrent accesses from different masters to different slaves

- 32-bit data bus
- Operation at a 1-to-1 clock frequency with the bus masters

## 11.4.2 Configuration

**Figure 11-1. Master-Slave Relation High-Speed Bus Matrix<sup>(1)</sup>**



1. The AHB-APB bridge D is only available on SAM C20N.

**Table 11-4. Bus Matrix Masters**

Bus Matrix Masters	Master ID
CM0+ - Cortex M0+ Processor	0
DSU - Device Service Unit	1
DMAC - Direct Memory Access Controller / Data Access	2

**Table 11-5. Bus Matrix Slaves**

Bus Matrix Slaves	Slave ID
Internal Flash Memory	0
SRAM Port 4 - CM0+ Access	1
SRAM Port 6 - DSU Access	2
AHB-APB Bridge A	3
AHB-APB Bridge B	4
AHB-APB Bridge C	5
SRAM Port 5 - DMAC Data Access	6
DIVAS - Divide Accelerator	7

**Table 11-6. SRAM Port Connections**

SRAM Port Connection	Port ID	Connection Type
CM0+ - Cortex M0+ Processor	0	Bus Matrix
DSU - Device Service Unit	1	Bus Matrix
DMAC - Direct Memory Access Controller - Data Access	2	Bus Matrix
DMAC - Direct Memory Access Controller - Fetch Access 0	3	Direct
DMAC - Direct Memory Access Controller - Fetch Access 1	4	Direct
DMAC - Direct Memory Access Controller - Write-Back Access 0	5	Direct
DMAC - Direct Memory Access Controller - Write-Back Access 1	6	Direct
Reserved	7	Direct
Reserved	8	Direct
MTB - Micro Trace Buffer	9	Direct

### 11.4.3 SRAM Quality of Service

To ensure that masters with latency requirements get sufficient priority when accessing RAM, the different masters can be configured to have a given priority for different type of access.

The Quality of Service (QoS) level is independently selected for each master accessing the RAM. For any access to the RAM the RAM also receives the QoS level. The QoS levels and their corresponding bit values for the QoS level configuration is shown in below.

**Table 11-7. Quality of Service Level Configuration**

Value	Name	Description
0x0	DISABLE	Background (no sensitive operation)
0x1	LOW	Sensitive Bandwidth
0x2	MEDIUM	Sensitive Latency
0x3	HIGH	Critical Latency

If a master is configured with QoS level DISABLE (0x0) or LOW (0x1) there will be minimum latency of one cycle for the RAM access.

The priority order for concurrent accesses are decided by two factors. First, the QoS level for the master and second, a static priority given by [Table 11-6](#). The lowest port ID has the highest static priority.

The MTB has fixed QoS level HIGH (0x3) and the DSU has fixed QoS level LOW (0x1).

The CPU QoS level can be written/read at address 0x41007110, bits [1:0]. Its reset value is 0x0.

Refer to different master QOSCTRL registers for configuring QoS for the other masters (DMAC).

## 12. PAC - Peripheral Access Controller

### 12.1 Overview

The Peripheral Access Controller provides an interface for the locking and unlocking of peripheral registers within the device. It reports all violations that could happen when accessing a peripheral: write protected access, illegal access, enable protected access, access when clock synchronization or software reset is on-going. These errors are reported in a unique interrupt flag for a peripheral. The PAC module also reports errors occurring at the slave bus level, when an access to a non-existing address is detected.

### 12.2 Features

- Manages write protection access and reports access errors for the peripheral modules or bridges

### 12.3 Block Diagram

Figure 12-1. PAC Block Diagram



### 12.4 Product Dependencies

In order to use this peripheral, other parts of the system must be configured correctly, as described below.

#### 12.4.1 IO Lines

Not applicable.

#### 12.4.2 Power Management

The PAC can continue to operate in any sleep mode where the selected source clock is running. The PAC interrupts can be used to wake up the device from sleep modes. The events can trigger other operations in the system without exiting sleep modes.

#### Related Links

## PM – Power Manager

### 12.4.3 Clocks

The PAC bus clock (CLK\_PAC\_APB) can be enabled and disabled in the Main Clock module. The default state of CLK\_PAC\_APB can be found in the related links.

#### Related Links

[MCLK – Main Clock](#)

[Peripheral Clock Masking](#)

### 12.4.4 DMA

Not applicable.

### 12.4.5 Interrupts

The interrupt request line is connected to the Interrupt Controller. Using the PAC interrupt requires the Interrupt Controller to be configured first.

**Table 12-1. Interrupt Lines**

Instances	NVIC Line
PAC	PACERR

#### Related Links

[Nested Vector Interrupt Controller](#)

### 12.4.6 Events

The events are connected to the Event System, which may need configuration.

#### Related Links

[EVSYS – Event System](#)

### 12.4.7 Debug Operation

When the CPU is halted in debug mode, write protection of all peripherals is disabled and the PAC continues normal operation.

### 12.4.8 Register Access Protection

All registers with write-access can be write-protected optionally by the Peripheral Access Controller (PAC), except for the following registers:

- Write Control (WRCTRL) register
- AHB Slave Bus Interrupt Flag Status and Clear (INTFLAGAHB) register
- Peripheral Interrupt Flag Status and Clear n (INTFLAG A/B/C...) registers

Optional write-protection by the Peripheral Access Controller (PAC) is denoted by the "PAC Write-Protection" property in each individual register description.

PAC write-protection does not apply to accesses through an external debugger.

## 12.5 Functional Description

### 12.5.1 Principle of Operation

The Peripheral Access Control module allows the user to set a write protection on peripheral modules and generate an interrupt in case of a peripheral access violation. The peripheral's protection can be set,

cleared or locked at the user discretion. A set of Interrupt Flag and Status registers informs the user on the status of the violation in the peripherals. In addition, slaves bus errors can be also reported in the cases where reserved area is accessed by the application.

## 12.5.2 Basic Operation

### 12.5.2.1 Initialization

After reset, the PAC is enabled.

### 12.5.2.2 Initialization, Enabling and Resetting

The PAC is always enabled after reset.

Only a hardware reset will reset the PAC module.

### 12.5.2.3 Operations

The PAC module allows the user to set, clear or lock the write protection status of all peripherals on all Peripheral Bridges.

If a peripheral register violation occurs, the Peripheral Interrupt Flag n registers (INTFLAGn) are updated to inform the user on the status of the violation in the peripherals connected to the Peripheral Bridge n (n = A,B,C ...). The corresponding Peripheral Write Control Status n register (STATUSn) gives the state of the write protection for all peripherals connected to the corresponding Peripheral Bridge n. Refer to the [Peripheral Access Errors](#) for details.

The PAC module also report the errors occurring at slave bus level when an access to reserved area is detected. AHB Slave Bus Interrupt Flag register (INTFLAGAHB) informs the user on the status of the violation in the corresponding slave. Refer to the [AHB Slave Bus Errors](#) for details.

### 12.5.2.4 Peripheral Access Errors

The following events will generate a Peripheral Access Error:

- Protected write: To avoid unexpected writes to a peripheral's registers, each peripheral can be write protected. Only the registers denoted as "PAC Write-Protection" in the module's datasheet can be protected. If a peripheral is not write protected, write data accesses are performed normally. If a peripheral is write protected and if a write access is attempted, data will not be written and peripheral returns an access error. The corresponding interrupt flag bit in the INTFLAGn register will be set.
- Illegal access: Access to an unimplemented register within the module.
- Synchronized write error: For write-synchronized registers an error will be reported if the register is written while a synchronization is ongoing.

When any of the INTFLAGn registers bit are set, an interrupt will be requested if the PAC interrupt enable bit is set.

### 12.5.2.5 Write Access Protection Management

Peripheral access control can be enabled or disabled by writing to the WRCTRL register.

The data written to the WRCTRL register is composed of two fields; WRCTRL.PERID and WRCTRL.KEY. The WRCTRL.PERID is an unique identifier corresponding to a peripheral. The WRCTRL.KEY is a key value that defines the operation to be done on the control access bit. These operations can be "clear protection", "set protection" and "set and lock protection bit".

The "clear protection" operation will remove the write access protection for the peripheral selected by WRCTRL.PERID. Write accesses are allowed for the registers in this peripheral.



The “set protection” operation will set the write access protection for the peripheral selected by WRCTRL.PERID. Write accesses are not allowed for the registers with write protection property in this peripheral.

The “set and lock protection” operation will set the write access protection for the peripheral selected by WRCTRL.PERID and locks the access rights of the selected peripheral registers. The write access protection will only be cleared by a hardware reset.

The peripheral access control status can be read from the corresponding STATUSn register.

## 12.5.2.6 Write Access Protection Management Errors

Only word-wise writes to the WRCTRL register will effectively change the access protection. Other type of accesses will have no effect and will cause a PAC write access error. This error is reported in the INTFLAGn.PAC bit corresponding to the PAC module.

PAC also offers an additional safety feature for correct program execution with an interrupt generated on double write clear protection or double write set protection. If a peripheral is write protected and a subsequent set protection operation is detected then the PAC returns an error, and similarly for a double clear protection operation.

In addition, an error is generated when writing a “set and lock” protection to a write-protected peripheral or when a write access is done to a locked set protection. This can be used to ensure that the application follows the intended program flow by always following a write protect with an unprotect and conversely. However in applications where a write protected peripheral is used in several contexts, e.g. interrupt, care should be taken so that either the interrupt can not happen while the main application or other interrupt levels manipulates the write protection status or when the interrupt handler needs to unprotect the peripheral based on the current protection status by reading the STATUS register.

The errors generated while accessing the PAC module registers (eg. key error, double protect error...) will set the INTFLAGn.PAC flag.

## 12.5.2.7 AHB Slave Bus Errors

The PAC module reports errors occurring at the AHB Slave bus level. These errors are generated when an access is performed at an address where no slave (bridge or peripheral) is mapped . These errors are reported in the corresponding bits of the INTFLAGAHB register.

## 12.5.2.8 Generating Events

The PAC module can also generate an event when any of the Interrupt Flag registers bit are set. To enable the PAC event generation, the control bit EVCTRL.ERREO must be set a '1'.

## 12.5.3 DMA Operation

Not applicable.

## 12.5.4 Interrupts

The PAC has the following interrupt source:

- Error (ERR): Indicates that a peripheral access violation occurred in one of the peripherals controlled by the PAC module, or a bridge error occurred in one of the bridges reported by the PAC
  - This interrupt is a synchronous wake-up source.

Each interrupt source has an interrupt flag associated with it. The interrupt flag in the Interrupt Flag Status and Clear (INTFLAGAHB and INTFLAGn) registers is set when the interrupt condition occurs. Each interrupt can be individually enabled by writing a '1' to the corresponding bit in the Interrupt Enable Set (INTENSET) register, and disabled by writing a '1' to the corresponding bit in the Interrupt Enable Clear (INTENCLR) register. An interrupt request is generated when the interrupt flag is set and the corresponding interrupt is enabled. The interrupt request remains active until the interrupt flag is cleared,

the interrupt is disabled, or the PAC is reset. All interrupt requests from the peripheral are ORed together on system level to generate one combined interrupt request to the NVIC. The user must read the INTFLAGAHB and INTFLAGn registers to determine which interrupt condition is present.

Note that interrupts must be globally enabled for interrupt requests to be generated.

## Related Links

[Nested Vector Interrupt Controller](#)

[Sleep Mode Controller](#)

### 12.5.5 Events

The PAC can generate the following output event:

- Error (ERR): Generated when one of the interrupt flag registers bits is set

Writing a '1' to an Event Output bit in the Event Control Register (EVCTRL.ERREO) enables the corresponding output event. Writing a '0' to this bit disables the corresponding output event.

### 12.5.6 Sleep Mode Operation

In Sleep mode, the PAC is kept enabled if an available bus master (CPU, DMA) is running. The PAC will continue to catch access errors from the module and generate interrupts or events.

### 12.5.7 Synchronization

Not applicable.

## 12.6 Register Summary

Offset	Name	Bit Pos.								
0x00	WRCTRL	7:0	PERID[7:0]							
0x01		15:8	PERID[15:8]							
0x02		23:16	KEY[7:0]							
0x03		31:24								
0x04	EVCTRL	7:0								ERREO
0x05	Reserved									
...										
0x07										
0x08	INTENCLR	7:0								ERR
0x09	INTENSET	7:0								ERR
0x0A	Reserved									
...										
0x0E										
0x0F										
0x10	INTFLAGAHB	7:0	DIVAS	LPRAMDMAC	HPB2	HPB0	HPB1	HSRAMDSU	HSRAMCM0P	FLASH
0x11		15:8								HPB3
0x12		23:16								
0x13		31:24								
0x14	INTFLAGA	7:0	GCLK	SUPC	OSC32KCTR L	OSCCTRL	RSTC	MCLK	PM	PAC
0x15		15:8					FREQM	EIC	RTC	WDT
0x16		23:16								
0x17		31:24								
0x18	INTFLAGB	7:0				MTB	DMAC	NVMCTRL	DSU	PORT
0x19		15:8								
0x1A		23:16								
0x1B		31:24								
0x1C	INTFLAGC	7:0		SERCOM5	SERCOM4	SERCOM3	SERCOM2	SERCOM1	SERCOM0	EVSYS
0x1D		15:8	TC3	TC2	TC1	TC0	TCC2	TCC1	TCC0	
0x1E		23:16	CCL	PTC		AC			ADC0	TC4
0x1F		31:24								
0x20	INTFLAGD	7:0				TC7	TC6	TC5	SERCOM7	SERCOM6
0x21		15:8								
0x22		23:16								
0x23		31:24								
0x24	Reserved									
...										
0x32										
0x33										
0x34	STATUSA	7:0	GCLK	SUPC	OSC32KCTR L	OSCCTRL	RSTC	MCLK	PM	PAC
0x35		15:8					FREQM	EIC	RTC	WDT
0x36		23:16								
0x37		31:24								
0x38	STATUSB	7:0				MTB	DMAC	NVMCTRL	DSU	PORT
0x39		15:8								

Offset	Name	Bit Pos.								
0x3A		23:16								
0x3B		31:24								
0x3C	STATUSC	7:0		SERCOM5	SERCOM4	SERCOM3	SERCOM2	SERCOM1	SERCOM0	EVSYS
0x3D		15:8	TC3	TC2	TC1	TC0	TCC2	TCC1	TCC0	
0x3E		23:16	CCL	PTC		AC			ADC0	TC4
0x3F		31:24								
0x40	STATUSD	7:0				TC7	TC6	TC5	SERCOM7	SERCOM6
0x41		15:8								
0x42		23:16								
0x43		31:24								

## 12.7 Register Description

Registers can be 8, 16, or 32 bits wide. Atomic 8-, 16- and 32-bit accesses are supported. In addition, the 8-bit quarters and 16-bit halves of a 32-bit register, and the 8-bit halves of a 16-bit register can be accessed directly.

Some registers are optionally write-protected by the Peripheral Access Controller (PAC). Optional PAC write-protection is denoted by the "PAC Write-Protection" property in each individual register description. For details, refer to the related links.

### 12.7.1 Write Control

**Name:** WRCTRL  
**Offset:** 0x00 [ID-00000a18]  
**Reset:** 0x00000000  
**Property:** –

Bit	31	30	29	28	27	26	25	24
Access								
Reset								
Bit	23	22	21	20	19	18	17	16
Access	KEY[7:0]							
Reset	0	0	0	0	0	0	0	0
Bit	15	14	13	12	11	10	9	8
Access	PERID[15:8]							
Reset	0	0	0	0	0	0	0	0
Bit	7	6	5	4	3	2	1	0
Access	PERID[7:0]							
Reset	0	0	0	0	0	0	0	0

### Bits 23:16 – KEY[7:0]: Peripheral Access Control Key

These bits define the peripheral access control key:

Value	Name	Description
0x0	OFF	No action
0x1	CLEAR	Clear the peripheral write control
0x2	SET	Set the peripheral write control
0x3	LOCK	Set and lock the peripheral write control until the next hardware reset

### Bits 15:0 – PERID[15:0]: Peripheral Identifier

The PERID represents the peripheral whose control is changed using the WRCTRL.KEY. The Peripheral Identifier is calculated following formula:

$$PERID = 32 * BridgeNumber + N$$

Where BridgeNumber represents the Peripheral Bridge Number (0 for Peripheral Bridge A, 1 for Peripheral Bridge B, etc). N represents the peripheral index from the respective Bridge Number:

**Table 12-2. PERID Values**

Periph. Bridge Name	BridgeNumber	PERID Values
A	0	0+N
B	1	32+N
C	2	64+N
D	3	96+N
E	4	128+N

## 12.7.2 Event Control

**Name:** EVCTRL  
**Offset:** 0x04 [ID-0000a18]  
**Reset:** 0x00  
**Property:** -

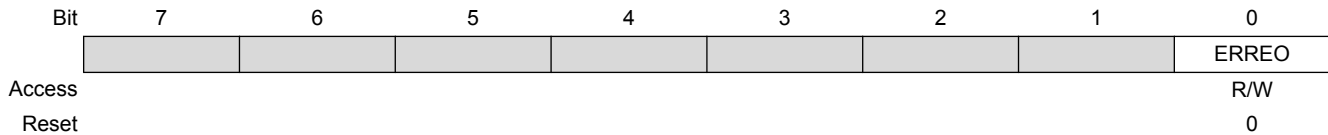

### Bit 0 – ERREO: Peripheral Access Error Event Output

This bit indicates if the Peripheral Access Error Event Output is enabled or disabled. When enabled, an event will be generated when one of the interrupt flag registers bits (INTFLAGAHB, INTFLAGn) is set:

Value	Description
0	Peripheral Access Error Event Output is disabled.
1	Peripheral Access Error Event Output is enabled.

### 12.7.3 Interrupt Enable Clear

This register allows the user to disable an interrupt without doing a read-modify-write operation. Changes in this register will also be reflected in the Interrupt Enable Set register (INTENSET).

**Name:** INTENCLR  
**Offset:** 0x08 [ID-0000a18]  
**Reset:** 0x00  
**Property:** PAC Write-Protection



### Bit 0 – ERR: Peripheral Access Error Interrupt Disable

This bit indicates that the Peripheral Access Error Interrupt is disabled and an interrupt request will be generated when one of the interrupt flag registers bits (INTFLAGAHB, INTFLAGn) is set:

Writing a '0' to this bit has no effect.

Writing a '1' to this bit will clear the Peripheral Access Error interrupt Enable bit and disables the corresponding interrupt request.

Value	Description
0	Peripheral Access Error interrupt is disabled.
1	Peripheral Access Error interrupt is enabled.

### 12.7.4 Interrupt Enable Set

This register allows the user to enable an interrupt without doing a read-modify-write operation. Changes in this register will also be reflected in the Interrupt Enable Set register (INTENCLR).

**Name:** INTENSET  
**Offset:** 0x09 [ID-0000a18]  
**Reset:** 0x00  
**Property:** PAC Write-Protection

Bit	7	6	5	4	3	2	1	0
								ERR
Access								R/W
Reset								0

### Bit 0 – ERR: Peripheral Access Error Interrupt Enable

This bit indicates that the Peripheral Access Error Interrupt is enabled and an interrupt request will be generated when one of the interrupt flag registers bits (INTFLAGAHB, INTFLAGn) is set:

Writing a '0' to this bit has no effect.

Writing a '1' to this bit will set the Peripheral Access Error interrupt Enable bit and enables the corresponding interrupt request.

Value	Description
0	Peripheral Access Error interrupt is disabled.
1	Peripheral Access Error interrupt is enabled.

### 12.7.5 AHB Slave Bus Interrupt Flag Status and Clear

This flag is cleared by writing a '1' to the flag.

This flag is set when an access error is detected by the SLAVE n, and will generate an interrupt request if INTENCLR/SET.ERR is '1'.

Writing a '0' to this bit has no effect.

Writing a '1' to this bit will clear the corresponding INTFLAGAHB interrupt flag.

**Name:** INTFLAGAHB  
**Offset:** 0x10 [ID-0000a18]  
**Reset:** 0x000000  
**Property:** –

Bit	31	30	29	28	27	26	25	24
Access								
Reset								
Bit	23	22	21	20	19	18	17	16
Access								
Reset								
Bit	15	14	13	12	11	10	9	8
								HPB3
Access								R/W
Reset								0
Bit	7	6	5	4	3	2	1	0
	DIVAS	LPRAMDMAC	HPB2	HPB0	HPB1	HSRAMDSU	HSRAMCM0P	FLASH
Access	R/W	R/W	R/W	R/W	R/W	R/W	R/W	R/W
Reset	0	0	0	0	0	0	0	0

**Bit 8 – HPB3: Interrupt Flag for SLAVE HPB3**

**Bit 7 – DIVAS: Interrupt Flag for SLAVE DIVAS**

**Bit 6 – LPRAMDMAC: Interrupt Flag for SLAVE LPRAMDMAC**

**Bit 5 – HPB2: Interrupt Flag for SLAVE HPB2**

**Bit 4 – HPB0: Interrupt Flag for SLAVE HPB0**

**Bit 3 – HPB1: Interrupt Flag for SLAVE HPB1**

**Bit 2 – HSRAMDSU: Interrupt Flag for SLAVE HSRAMDSU**

**Bit 1 – HSRAMCM0P: Interrupt Flag for SLAVE HSRAMCM0P**

**Bit 0 – FLASH: Interrupt Flag for SLAVE FLASH**

### 12.7.6 Peripheral Interrupt Flag Status and Clear A

This flag is cleared by writing a one to the flag.

This flag is set when a Peripheral Access Error occurs while accessing the peripheral associated with the respective INTFLAGA bit, and will generate an interrupt request if INTENCLR/SET.ERR is one.

Writing a zero to this bit has no effect.

Writing a one to this bit will clear the corresponding INTFLAGA interrupt flag.

**Name:** INTFLAGA  
**Offset:** 0x14 [ID-00000a18]  
**Reset:** 0x000000  
**Property:** –



Bit	31	30	29	28	27	26	25	24
Access								
Reset								
Bit	23	22	21	20	19	18	17	16
Access								
Reset								
Bit	15	14	13	12	11	10	9	8
					FREQM	EIC	RTC	WDT
Access					R/W	R/W	R/W	R/W
Reset					0	0	0	0
Bit	7	6	5	4	3	2	1	0
	GCLK	SUPC	OSC32KCTRL	OSCCTRL	RSTC	MCLK	PM	PAC
Access	R/W	R/W	R/W	R/W	R/W	R/W	R/W	R/W
Reset	0	0	0	0	0	0	0	0

**Bit 11 – FREQM: Interrupt Flag for FREQM**

**Bit 10 – EIC: Interrupt Flag for EIC**

**Bit 9 – RTC: Interrupt Flag for RTC**

**Bit 8 – WDT: Interrupt Flag for WDT**

**Bit 7 – GCLK: Interrupt Flag for GCLK**

**Bit 6 – SUPC: Interrupt Flag for SUPC**

**Bit 5 – OSC32KCTRL: Interrupt Flag for OSC32KCTRL**

**Bit 4 – OSCCTRL: Interrupt Flag for OSCCTRL**

**Bit 3 – RSTC: Interrupt Flag for RSTC**

**Bit 2 – MCLK: Interrupt Flag for MCLK**

**Bit 1 – PM: Interrupt Flag for PM**

**Bit 0 – PAC: Interrupt Flag for PAC**

### 12.7.7 Peripheral Interrupt Flag Status and Clear B

This flag is cleared by writing a '1' to the flag.

This flag is set when a Peripheral Access Error occurs while accessing the peripheral associated with the respective INTFLAGB bit, and will generate an interrupt request if INTENCLR/SET.ERR is '1'.

Writing a '0' to this bit has no effect.

Writing a '1' to this bit will clear the corresponding INTFLAGB interrupt flag.

**Name:** INTFLAGB  
**Offset:** 0x18 [ID-00000a18]  
**Reset:** 0x000000  
**Property:** –



**Bit 4 – MTB: Interrupt Flag for MTB**

**Bit 3 – DMAC: Interrupt Flag for DMAC**

**Bit 2 – NVMCTRL: Interrupt Flag for NVMCTRL**

**Bit 1 – DSU: Interrupt Flag for DSU**

**Bit 0 – PORT: Interrupt Flag for PORT**

### 12.7.8 Peripheral Interrupt Flag Status and Clear C

This flag is cleared by writing a one to the flag.

This flag is set when a Peripheral Access Error occurs while accessing the peripheral associated with the respective INTFLAGC bit, and will generate an interrupt request if INTENCLR/SET.ERR is one.

Writing a zero to this bit has no effect.

Writing a one to this bit will clear the corresponding INTFLAGC interrupt flag.

**Name:** INTFLAGC  
**Offset:** 0x1C [ID-00000a18]  
**Reset:** 0x000000  
**Property:** –

Bit	31	30	29	28	27	26	25	24
Access								
Reset								
Bit	23	22	21	20	19	18	17	16
	CCL	PTC		AC			ADC0	TC4
Access	R/W	R/W		R/W			R/W	R/W
Reset	0	0		0			0	0
Bit	15	14	13	12	11	10	9	8
	TC3	TC2	TC1	TC0	TCC2	TCC1	TCC0	
Access	R/W	R/W	R/W	R/W	R/W	R/W	R/W	
Reset	0	0	0	0	0	0	0	
Bit	7	6	5	4	3	2	1	0
		SERC0M5	SERC0M4	SERC0M3	SERC0M2	SERC0M1	SERC0M0	EVSYS
Access		R/W	R/W	R/W	R/W	R/W	R/W	R/W
Reset		0	0	0	0	0	0	0

**Bit 23 – CCL: Interrupt Flag for CCL**

**Bit 22 – PTC: Interrupt Flag for PTC**

**Bit 20 – AC: Interrupt Flag for AC**

**Bit 17 – ADC0: Interrupt Flag for ADC**

**Bits 12, 13, 14, 15, 16 – TC: Interrupt Flag for TC<sub>n</sub> [n = 4..0]**

**Bits 9, 10, 11 – TCC: Interrupt Flag for TCC<sub>n</sub> [n = 2..0]**

**Bits 1, 2, 3, 4, 5, 6 – SERCOM: Interrupt Flag for SERCOM<sub>n</sub> [n = 5..0]**

**Bit 0 – EVSYS: Interrupt Flag for EVSYS**

## 12.7.9 Peripheral Interrupt Flag Status and Clear D

This flag is cleared by writing a one to the flag.

This flag is set when a Peripheral Access Error occurs while accessing the peripheral associated with the respective INTFLAGD bit, and will generate an interrupt request if INTENCLR/SET.ERR is one.

Writing a zero to this bit has no effect.

Writing a one to this bit will clear the corresponding INTFLAGD interrupt flag.

**Name:** INTFLAGD

**Offset:** 0x20 [ID-00000a18]

**Reset:** 0x000000

**Property:** –

Bit	31	30	29	28	27	26	25	24
Access								
Reset								
Bit	23	22	21	20	19	18	17	16
Access								
Reset								
Bit	15	14	13	12	11	10	9	8
Access								
Reset								
Bit	7	6	5	4	3	2	1	0
				TC7	TC6	TC5	SERC0M7	SERC0M6
Access				R/W	R/W	R/W	R/W	R/W
Reset				0	0	0	0	0

**Bits 2, 3, 4 – TC5, TC6, TC7: Interrupt Flag for TCn [n = 7..5]**

**Bits 0, 1 – SERCOM6, SERCOM7: Interrupt Flag for SERCOMn [n = 7..6]**

### 12.7.10 Peripheral Write Protection Status A

Writing to this register has no effect.

Reading STATUS register returns peripheral write protection status:

Value	Description
0	Peripheral is not write protected.
1	Peripheral is write protected.

**Name:** STATUSA

**Offset:** 0x34 [ID-00000a18]

**Reset:** 0x000000

**Property:** –

Bit	31	30	29	28	27	26	25	24
Access								
Reset								
Bit	23	22	21	20	19	18	17	16
Access								
Reset								
Bit	15	14	13	12	11	10	9	8
					FREQM	EIC	RTC	WDT
Access					R	R	R	R
Reset					0	0	0	0
Bit	7	6	5	4	3	2	1	0
	GCLK	SUPC	OSC32KCTRL	OSCCTRL	RSTC	MCLK	PM	PAC
Access	R	R	R	R	R	R	R	R
Reset	0	0	0	0	0	0	0	0

**Bit 11 – FREQM: Peripheral FREQM Write Protection Status**

**Bit 10 – EIC: Peripheral EIC Write Protection Status**

**Bit 9 – RTC: Peripheral RTC Write Protection Status**

**Bit 8 – WDT: Peripheral WDT Write Protection Status**

**Bit 7 – GCLK: Peripheral GCLK Write Protection Status**

**Bit 6 – SUPC: Peripheral SUPC Write Protection Status**

**Bit 5 – OSC32KCTRL: Peripheral OSC32KCTRL Write Protection Status**

**Bit 4 – OSCCTRL: Peripheral OSCCTRL Write Protection Status**

**Bit 3 – RSTC: Peripheral RSTC Write Protection Status**

**Bit 2 – MCLK: Peripheral MCLK Write Protection Status**

**Bit 1 – PM: Peripheral PM Write Protection Status**

**Bit 0 – PAC: Peripheral PAC Write Protection Status**

## 12.7.11 Peripheral Write Protection Status B

Writing to this register has no effect.

Reading STATUS register returns peripheral write protection status:

Value	Description
0	Peripheral is not write protected.
1	Peripheral is write protected.

**Name:** STATUSB  
**Offset:** 0x38 [ID-00000a18]  
**Reset:** 0x000000  
**Property:** –



**Bit 4 – MTB: Peripheral MTB Write Protection Status**

**Bit 3 – DMAC: Peripheral DMAC Write Protection Status**

**Bit 2 – NVMCTRL: Peripheral NVMCTRL Write Protection Status**

**Bit 1 – DSU: Peripheral DSU Write Protection Status**

**Bit 0 – PORT: Peripheral PORT Write Protection Status**

### 12.7.12 Peripheral Write Protection Status C

Writing to this register has no effect.

Reading STATUS register returns peripheral write protection status:

Value	Description
0	Peripheral is not write protected.
1	Peripheral is write protected.

**Name:** STATUSC  
**Offset:** 0x3C [ID-00000a18]  
**Reset:** 0x000000  
**Property:** –

Bit	31	30	29	28	27	26	25	24
Access								
Reset								
Bit	23	22	21	20	19	18	17	16
	CCL	PTC		AC			ADC0	TC4
Access	R	R		R			R	R
Reset	0	0		0			0	0
Bit	15	14	13	12	11	10	9	8
	TC3	TC2	TC1	TC0	TCC2	TCC1	TCC0	
Access	R	R	R	R	R	R	R	
Reset	0	0	0	0	0	0	0	
Bit	7	6	5	4	3	2	1	0
		SERCOM5	SERCOM4	SERCOM3	SERCOM2	SERCOM1	SERCOM0	EVSYS
Access		R	R	R	R	R	R	R
Reset		0	0	0	0	0	0	0

**Bit 23 – CCL: Peripheral CCL Write Protection Status**

**Bit 22 – PTC: Peripheral PTC Write Protection Status**

**Bit 20 – AC: Peripheral AC Write Protection Status**

**Bit 17 – ADC0: Peripheral ADC0 Write Protection Status**

**Bits 12, 13, 14, 15, 16 – TC: Peripheral TCn Write Protection Status [n = 4..0]**

**Bits 9, 10, 11 – TCC: Peripheral TCCn [n = 2..0] Write Protection Status TCCn [n = 2..0]**

**Bits 1, 2, 3, 4, 5, 6 – SERCOM: Peripheral SERCOMn Write Protection Status [n = 5..0]**

**Bit 0 – EVSYS: Peripheral EVSYS Write Protection Status**

### 12.7.13 Peripheral Write Protection Status D

Writing to this register has no effect.

Reading STATUS register returns peripheral write protection status:

Value	Description
0	Peripheral is not write protected.
1	Peripheral is write protected.

**Name:** STATUSD  
**Offset:** 0x40 [ID-00000a18]  
**Reset:** 0x000000  
**Property:** –



**Bits 2, 3, 4 – TC5, TC6, TC7: Peripheral TCn Write Protection Status [n = 7..5]**

**Bits 0, 1 – SERCOM6, SERCOM7: Peripheral SERCOMn Write Protection Status [n = 7..6]**



## 13. Peripherals Configuration Summary

### 13.1 SAM C20N

**Table 13-1. Peripherals Configuration Summary SAM C20 N**

Peripheral Name	Base Address	IRQ Line	AHB Clock		APB Clock		Generic Clock		PAC		Events		DMA	
			Index	Enabled at Reset	Index	Enabled at Reset	Index	Index	Prot at Reset	User	Generator	Index	Sleep Walking	
AHB-APB Bridge A	0x40000000		0	Y										N/A
PAC	0x40000000	0	10	Y	0	Y		0	N		85 : ACCERR			N/A
PM	0x40000400	0			1	Y		1	N					N/A
MCLK	0x40000800	0			2	Y		2	N					Y
RSTC	0x40000C00				3	Y		3	N					N/A
OSCCTRL	0x40001000	0			4	Y	0: FDPLL96M clk source 1: FDPLL96M 32kHz	4	N		0: XOSC_FAIL			Y
OSC32KCTRL	0x40001400	0			5	Y		5	N		1: XOSC32K_FAIL			Y
SUPC	0x40001800	0			6	Y		6	N					N/A
GCLK	0x40001C00				7	Y		7	N					N/A
WDT	0x40002000	1			8	Y		8	N					Y
RTC	0x40002400	2			9	Y		9	N		2: CMP0/ALARM0 3: CMP1 4: OVF5-1 5:12: PER0-7			Y
EIC	0x40002800	3, NMI			10	Y	2	10	N		13-28: EXTINT0-15			Y
FREQM	0x40002C00	4			11	Y	3: Measure 4: Reference	11	N					N/A
AHB-APB Bridge B	0x41000000		1	Y										N/A
PORT	0x41000000				0	Y		0	N	1-4 : EV0-3				Y
DSU	0x41002000		3	Y	1	Y		1	Y					N/A
NVMCTRL	0x41004000	6	5	Y	2	Y	39	2	N					Y
DMAC	0x41006000	7	7	Y				3	N	5-8: CH0-3	30-33: CH0-3			Y
MTB	0x41008000								N	45: START 46: STOP				N/A
AHB-APB Bridge C	0x42000000		2	Y										N/A
EVSYS	0x42000000	8			0	N	6-17: one per CHANNEL	0	N					Y
SERCOM0	0x42000400	9			1	N	19: CORE 18: SLOW	1	N				2: RX 3: TX	Y
SERCOM1	0x42000800	10			2	N	20: CORE 18: SLOW	2	N				4: RX 5: TX	Y
SERCOM2	0x42000C00	11			3	N	21: CORE 18: SLOW	3	N				6: RX 7: TX	Y
SERCOM3	0x42001000	12			4	N	22: CORE 18: SLOW	4	N				8: RX 9: TX	Y
SERCOM4	0x42001400	13			5	N	23: CORE	5	N				10: RX	Y

# SAM C20 Family

Peripheral Name	Base Address	IRQ Line	AHB Clock		APB Clock		Generic Clock	PAC		Events		DMA	
			Index	Enabled at Reset	Index	Enabled at Reset	Index	Index	Prot at Reset	User	Generator	Index	Sleep Walking
							18: SLOW					11: TX	
SERCOM5	0x42001800	14			6	N	25: CORE 24: SLOW	6	N			12: RX 13: TX	Y
TCC0	0x42002400	17			9	N	28	9	N	9-10: EV0-1 11-14: MC0-3	34: OVF 35: TRG 36: CNT 37-40: MC0-3	16: OVF 17-20: MC0-3	Y
TCC1	0x42002800	18			10	N	28	10	N	15-16: EV0-1 17-18: MC0-1	41: OVF 42: TRG 43: CNT 44-45: MC0-1	21: OVF 22-23: MC0-1	Y
TCC2	0x42002C00	19			11	N	29	11	N	19-20: EV0-1 21-22: MC0-1	46: OVF 47: TRG 48: CNT 49-50: MC0-1	24: OVF 25-26: MC0-1	Y
TC0	0x42003000	20			12	N	30	12	N	23: EVU	51: OVF 52-53: MC0-1	27: OVF 28-29: MC0-1	Y
TC1	0x42003400	21			13	N	30	13	N	24: EVU	54: OVF 55-56: MC0-1	30: OVF 31-32: MC0-1	Y
TC2	0x42003800	22			14	N	31	14	N	25: EVU	57: OVF 58-59: MC0-1	33: OVF 34-35: MC0-1	Y
TC3	0x42003C00	23			15	N	31	15	N	26: EVU	60: OVF 61-62: MC0-1	36: OVF 37-38: MC0-1	Y
TC4	0x42004000	24			16	N	32	16	N	27: EVU	63: OVF 64-65: MC0-1	39: OVF 40-41: MC0-1	Y
ADC0	0x42004400	25			17	N	33	17	N	28: START 29: SYNC	66: RESRDY 67: WINMON	42: RESRDY	Y
AC	0x42005000	27			20	N	40	20	N	34-37: SOC0-3	72-75: COMP0-3 76-77: WIN0-1		Y
PTC	0x42005800	30			22	N	37	22	N	39: STCONV	79: EOC 80: WCOMP	EOC: 46 WCOMP: 47 SEQ: 48	
CCL	0x42005C00				23	N	38	23	N	40-43 : LUTIN0-3	81-84: LUTOUT0-3		Y
AHB-APB Bridge D	0x43000000		13	Y	0								N/A
SERCOM6	0x43000000	9			0	N	41: CORE 18: SLOW	0	N			49: RX 50: TX	Y
SERCOM7	0x43000400	10			1	N	42: CORE 18: SLOW	1	N			51: RX 52: TX	Y
TC5	0x43000800	20			2	N	43	2	N	47: EVU	87: OVF 88-89: MC0-1	53: OVF 54-55: MC0-1	Y
TC6	0x43000C00	21			3	N	44	3	N	48:EVU	90: OVF 91-92: MC0-1	56: OVF 57-58: MC0-1	Y

# SAM C20 Family

Peripheral Name	Base Address	IRQ Line	AHB Clock		APB Clock		Generic Clock	PAC		Events		DMA	
			Index	Enabled at Reset	Index	Enabled at Reset	Index	Index	Prot at Reset	User	Generator	Index	Sleep Walking
TC7	0x43001000	22			4	N	45	4	N	49:EVU	93: OVF 94-95: MCO-1	59: OVF 60-61: MCO-1	Y
DIVAS	0x48000000		12	Y									N/A

## 13.2 SAM C20J, G, E

Table 13-2. Peripherals Configuration Summary SAM C20 J, G, E

Peripheral Name	Base Address	IRQ Line	AHB Clock		APB Clock		Generic Clock	PAC		Events		DMA	
			Index	Enabled at Reset	Index	Enabled at Reset	Index	Index	Prot at Reset	User	Generator	Index	Sleep Walking
AHB-APB Bridge A	0x40000000		0	Y									N/A
PAC	0x44000000	0	10	Y	0	Y		0	N		85 : ACCERR		N/A
PM	0x40000400	0			1	Y		1	N				N/A
MCLK	0x40000800	0			2	Y		2	N				Y
RSTC	0x40000C00				3	Y		3	N				N/A
OSCCTRL	0x40001000	0			4	Y	0: FDPLL96M clk source 1: FDPLL96M 32kHz	4	N		0: XOSC_FAIL		Y
OSC32KCTRL	0x40001400	0			5	Y		5	N		1: XOSC32K_FAIL		Y
SUPC	0x40001800	0			6	Y		6	N				N/A
GCLK	0x40001C00				7	Y		7	N				N/A
WDT	0x40002000	1			8	Y		8	N				Y
RTC	0x40002400	2			9	Y		9	N		2: CMP0/ALARM0 3: CMP1 4: OVF 5-12: PER0-7		Y
EIC	0x40002800	3, NMI			10	Y	2	10	N		13-28: EXTINT0-15		Y
FREQM	0x40002C00	4			11	Y	3: Measure 4: Reference	11	N				N/A
AHB-APB Bridge B	0x41000000		1	Y									N/A
PORT	0x41000000				0	Y		0	N	1-4 : EV0-3			Y
DSU	0x41002000		3	Y	1	Y		1	Y				N/A
NVMCTRL	0x41004000	6	5	Y	2	Y	39	2	N				Y
DMAC	0x41006000	7	7	Y				3	N	5-8: CH0-3	30-33: CH0-3		Y
MTB	0x41008000								N	44: START 45: STOP			N/A
AHB-APB Bridge C	0x42000000		2	Y									N/A
EVSYS	0x42000000	8			0	N	6-17: one per CHANNEL	0	N				Y
SERCOM0	0x42000400	9			1	N	19: CORE 18: SLOW	1	N			2: RX 3: TX	Y
SERCOM1	0x42000800	10			2	N	20: CORE 18: SLOW	2	N			4: RX 5: TX	Y
SERCOM2	0x42000C00	11			3	N	21: CORE 18: SLOW	3	N			6: RX 7: TX	Y

# SAM C20 Family

Peripheral Name	Base Address	IRQ Line	AHB Clock		APB Clock		Generic Clock	PAC		Events		DMA	Sleep Walking
			Index	Enabled at Reset	Index	Enabled at Reset	Index	Index	Prot at Reset	User	Generator	Index	
SERCOM3	0x42001000	12			4	N	22: CORE 18: SLOW	4	N			8: RX 9: TX	Y
SERCOM4	0x42001400	13			5	N	23: CORE 18: SLOW	5	N			10: RX 11: TX	Y
SERCOM5	0x42001800	14			6	N	25: CORE 24: SLOW	6	N			12: RX 13: TX	Y
TCC0	0x42002400	17			9	N	28	9	N	9-10: EV0-1 11-14: MC0-3	34: OVF 35: TRG 36: CNT 37-40: MC0-3	16: OVF 17-20: MC0-3	Y
TCC1	0x42002800	18			10	N	28	10	N	15-16: EV0-1 17-18: MC0-1	41: OVF 42: TRG 43: CNT 44-45: MC0-1	21: OVF 22-23: MC0-1	Y
TCC2	0x42002C00	19			11	N	29	11	N	19-20: EV0-1 21-22: MC0-1	46: OVF 47: TRG 48: CNT 49-50: MC0-1	24: OVF 25-26: MC0-1	Y
TC0	0x42003000	20			12	N	30	12	N	23: EVU	51: OVF 52-53: MC0-1	27: OVF 28-29: MC0-1	Y
TC1	0x42003400	21			13	N	30	13	N	24: EVU	54: OVF 55-56: MC0-1	30: OVF 21-32: MC0-1	Y
TC2	0x42003800	22			14	N	31	14	N	25: EVU	57: OVF 58-59: MC0-1	33: OVF 23-35: MC0-1	Y
TC3	0x42003C00	23			15	N	31	15	N	26: EVU	60: OVF 61-62: MC0-1	36: OVF 37-38: MC0-1	Y
TC4	0x42004000	24			16	N	32	16	N	27: EVU	63: OVF 64-65: MC0-1	39: OVF 40-41: MC0-1	Y
ADC0	0x42004400	25			17	N	33	17	N	28: START 29: SYNC	66: RESRDY 67: WINMON	42: RESRDY	Y
AC	0x42005000	27			20	N	34	20	N	34-37: SOC0-3	72-75: COMP0-3 76-77: WIN0-1		Y
PTC	0x42005800	30			22	N	37	22	N	39: STCONV	79: EOC 80: WCOMP	EOC: 46 WCOMP: 47 SEQ: 48	
CCL	0x42005C00				23	N	38	23	N	40-43 : LUTIN0-3	781-84: LUTOUT0-3		Y
DIVAS	0x48000000		12	Y									N/A

## 14. DSU - Device Service Unit

### 14.1 Overview

The Device Service Unit (DSU) provides a means of detecting debugger probes. It enables the ARM Debug Access Port (DAP) to have control over multiplexed debug pads and CPU reset. The DSU also provides system-level services to debug adapters in an ARM debug system. It implements a CoreSight Debug ROM that provides device identification as well as identification of other debug components within the system. Hence, it complies with the ARM Peripheral Identification specification. The DSU also provides system services to applications that need memory testing, as required for IEC60730 Class B compliance, for example. The DSU can be accessed simultaneously by a debugger and the CPU, as it is connected on the High-Speed Bus Matrix. For security reasons, some of the DSU features will be limited or unavailable when the device is protected by the NVMCTRL security bit.

#### Related Links

[System Services Availability when Accessed Externally and Device is Protected NVMCTRL – Non-Volatile Memory Controller Security Bit](#)

### 14.2 Features

- CPU reset extension
- Debugger probe detection (Cold- and Hot-Plugging)
- Chip-Erase command and status
- 32-bit cyclic redundancy check (CRC32) of any memory accessible through the bus matrix
- ARM® CoreSight™ compliant device identification
- Two debug communications channels
- Debug access port security filter
- Onboard memory built-in self-test (MBIST)

### 14.3 Block Diagram

Figure 14-1. DSU Block Diagram

### 14.4 Signal Description

The DSU uses three signals to function.

Signal Name	Type	Description
RESET	Digital Input	External reset
SWCLK	Digital Input	SW clock
SWDIO	Digital I/O	SW bidirectional data pin

#### Related Links

[I/O Multiplexing and Considerations](#)

## 14.5 Product Dependencies

In order to use this peripheral, other parts of the system must be configured correctly, as described below.

### 14.5.1 IO Lines

The SWCLK pin is by default assigned to the DSU module to allow debugger probe detection and to stretch the CPU reset phase. For more information, refer to [Debugger Probe Detection](#). The Hot-Plugging feature depends on the PORT configuration. If the SWCLK pin function is changed in the PORT or if the PORT\_MUX is disabled, the Hot-Plugging feature is disabled until a power-reset or an external reset.

### 14.5.2 Power Management

The DSU will continue to operate in any sleep mode where the selected source clock is running.

#### Related Links

[PM – Power Manager](#)

### 14.5.3 Clocks

The DSU bus clocks (CLK\_DSU\_APB and CLK\_DSU\_AHB) can be enabled and disabled by the Main Clock Controller.

#### Related Links

[PM – Power Manager](#)

[MCLK – Main Clock](#)

[Peripheral Clock Masking](#)

### 14.5.4 DMA

### 14.5.5 Interrupts

Not applicable.

### 14.5.6 Events

Not applicable.

### 14.5.7 Register Access Protection

Registers with write-access can be optionally write-protected by the Peripheral Access Controller (PAC), except for the following:

- Debug Communication Channel 0 register (DCC0)
- Debug Communication Channel 1 register (DCC1)

**Note:** Optional write-protection is indicated by the "PAC Write-Protection" property in the register description.

When the CPU is halted in debug mode, all write-protection is automatically disabled. Write-protection does not apply for accesses through an external debugger.

#### Related Links

[PAC - Peripheral Access Controller](#)

### 14.5.8 Analog Connections

Not applicable.

## 14.6 Debug Operation

### 14.6.1 Principle of Operation

The DSU provides basic services to allow on-chip debug using the ARM Debug Access Port and the ARM processor debug resources:

- CPU reset extension
- Debugger probe detection

For more details on the ARM debug components, refer to the ARM Debug Interface v5 Architecture Specification.

### 14.6.2 CPU Reset Extension

“CPU reset extension” refers to the extension of the reset phase of the CPU core after the external reset is released. This ensures that the CPU is not executing code at startup while a debugger is connects to the system. The debugger is detected on a  $\overline{\text{RESET}}$  release event when SWCLK is low. At startup, SWCLK is internally pulled up to avoid false detection of a debugger if the SWCLK pin is left unconnected. When the CPU is held in the reset extension phase, the CPU Reset Extension bit of the Status A register (STATUSA.CRSTEXT) is set. To release the CPU, write a '1' to STATUSA.CRSTEXT. STATUSA.CRSTEXT will then be set to '0'. Writing a '0' to STATUSA.CRSTEXT has no effect. For security reasons, it is not possible to release the CPU reset extension when the device is protected by the NVMCTRL security bit. Trying to do so sets the Protection Error bit (PERR) of the Status A register (STATUSA.PERR).

**Figure 14-2. Typical CPU Reset Extension Set and Clear Timing Diagram**



#### Related Links

[NVMCTRL – Non-Volatile Memory Controller Security Bit](#)

### 14.6.3 Debugger Probe Detection

#### 14.6.3.1 Cold Plugging

Cold-Plugging is the detection of a debugger when the system is in reset. Cold-Plugging is detected when the CPU reset extension is requested, as described above.

#### 14.6.3.2 Hot Plugging

Hot-Plugging is the detection of a debugger probe when the system is not in reset. Hot-Plugging is not possible under reset because the detector is reset when POR or  $\overline{\text{RESET}}$  are asserted. Hot-Plugging is

active when a SWCLK falling edge is detected. The SWCLK pad is multiplexed with other functions and the user must ensure that its default function is assigned to the debug system. If the SWCLK function is changed, the Hot-Plugging feature is disabled until a power-reset or external reset occurs. Availability of the Hot-Plugging feature can be read from the Hot-Plugging Enable bit of the Status B register (STATUSB.HPE).

**Figure 14-3. Hot-Plugging Detection Timing Diagram**



The presence of a debugger probe is detected when either Hot-Plugging or Cold-Plugging is detected. Once detected, the Debugger Present bit of the Status B register (STATUSB.DBGPRES) is set. For security reasons, Hot-Plugging is not available when the device is protected by the NVMCTRL security bit.

This detection requires that pads are correctly powered. Thus, at cold startup, this detection cannot be done until POR is released. If the device is protected, Cold-Plugging is the only way to detect a debugger probe, and so the external reset timing must be longer than the POR timing. If external reset is deasserted before POR release, the user must retry the procedure above until it gets connected to the device.

### Related Links

[NVMCTRL – Non-Volatile Memory Controller Security Bit](#)

## 14.7 Chip Erase

Chip-Erase consists of removing all sensitive information stored in the chip and clearing the NVMCTRL security bit. Therefore, all volatile memories and the Flash memory (including the EEPROM emulation area) will be erased. The Flash auxiliary rows, including the user row, will not be erased.

When the device is protected, the debugger must first reset the device in order to be detected. This ensures that internal registers are reset after the protected state is removed. The Chip-Erase operation is triggered by writing a '1' to the Chip-Erase bit in the Control register (CTRL.CE). This command will be discarded if the DSU is protected by the Peripheral Access Controller (PAC). Once issued, the module clears volatile memories prior to erasing the Flash array. To ensure that the Chip-Erase operation is completed, check the Done bit of the Status A register (STATUSA.DONE).

The Chip-Erase operation depends on clocks and power management features that can be altered by the CPU. For that reason, it is recommended to issue a Chip-Erase after a Cold-Plugging procedure to ensure that the device is in a known and safe state.

The recommended sequence is as follows:

1. Issue the Cold-Plugging procedure (refer to [Cold Plugging](#)). The device then:
  - 1.1. Detects the debugger probe.



- 1.2. Holds the CPU in reset.
2. Issue the Chip-Erase command by writing a '1' to CTRL.CE. The device then:
  - 2.1. Clears the system volatile memories.
  - 2.2. Erases the whole Flash array (including the EEPROM emulation area, not including auxiliary rows).
  - 2.3. Erases the lock row, removing the NVMCTRL security bit protection.
3. Check for completion by polling STATUSA.DONE (read as '1' when completed).
4. Reset the device to let the NVMCTRL update the fuses.

## 14.8 Programming

Programming the Flash or RAM memories is only possible when the device is not protected by the NVMCTRL security bit. The programming procedure is as follows:

1. At power up,  $\overline{\text{RESET}}$  is driven low by a debugger. The on-chip regulator holds the system in a POR state until the input supply is above the POR threshold (refer to Power-On Reset (POR) characteristics). The system continues to be held in this static state until the internally regulated supplies have reached a safe operating state.
2. The PM starts, clocks are switched to the slow clock (Core Clock, System Clock, Flash Clock and any Bus Clocks that do not have clock gate control). Internal resets are maintained due to the external reset.
3. The debugger maintains a low level on SWCLK.  $\overline{\text{RESET}}$  is released, resulting in a debugger Cold-Plugging procedure.
4. The debugger generates a clock signal on the SWCLK pin, the Debug Access Port (DAP) receives a clock.
5. The CPU remains in Reset due to the Cold-Plugging procedure; meanwhile, the rest of the system is released.
6. A Chip-Erase is issued to ensure that the Flash is fully erased prior to programming.
7. The debugger then configures the NVIC to catch the Cortex-M4 core reset vector fetch. For more information on how to program the NVIC, refer to the ARMv7-M Architecture Reference Manual.
8. Release the "CPU reset extension" phase by writing a '1' to the Status A register CPU Reset Phase Extension bit (STATUSA.CRSTEXT).
9. Programming is available through the AHB-AP.
10. After the operation is completed, the chip can be restarted either by asserting  $\overline{\text{RESET}}$  or toggling power. Make sure that the SWCLK pin is high when releasing  $\overline{\text{RESET}}$  to prevent extending the CPU reset.

### Related Links

[Electrical Characteristics 85°C \(SAM C20J/G/E\)](#)  
[NVMCTRL – Non-Volatile Memory Controller](#)  
[Security Bit](#)

## 14.9 Intellectual Property Protection

Intellectual property protection consists of restricting access to internal memories from external tools when the device is protected, and this is accomplished by setting the NVMCTRL security bit. This protected state can be removed by issuing a Chip-Erase (refer to [Chip Erase](#)). When the device is protected, read/write accesses using the AHB-AP are limited to the DSU address range and DSU

commands are restricted. When issuing a Chip-Erase, sensitive information is erased from volatile memory and Flash.

The DSU implements a security filter that monitors the AHB transactions inside the DAP. If the device is protected, then AHB-AP read/write accesses outside the DSU external address range are discarded, causing an error response that sets the ARM AHB-AP sticky error bits (refer to the ARM Debug Interface v5 Architecture Specification on <http://www.arm.com>).

The DSU is intended to be accessed either:

- Internally from the CPU, without any limitation, even when the device is protected
- Externally from a debug adapter, with some restrictions when the device is protected

For security reasons, DSU features have limitations when used from a debug adapter. To differentiate external accesses from internal ones, the first 0x100 bytes of the DSU register map has been mirrored at offset 0x100:

- The first 0x100 bytes form the internal address range
- The next 0x100 bytes form the external address range

When the device is protected, the DAP can only issue MEM-AP accesses in the DSU range 0x0100-0x2000.

The DSU operating registers are located in the 0x0000-0x00FF area and remapped in 0x0100-0x01FF to differentiate accesses coming from a debugger and the CPU. If the device is protected and an access is issued in the region 0x0100-0x01FF, it is subject to security restrictions. For more information, refer to the [Table 14-1](#).

**Figure 14-4. APB Memory Mapping**



Some features not activated by APB transactions are not available when the device is protected:

**Table 14-1. Feature Availability Under Protection**

Features	Availability when the device is protected
CPU Reset Extension	Yes
Clear CPU Reset Extension	No
Debugger Cold-Plugging	Yes
Debugger Hot-Plugging	No

**Related Links**

[NVMCTRL – Non-Volatile Memory Controller](#)  
[Security Bit](#)

## 14.10 Device Identification

Device identification relies on the ARM CoreSight component identification scheme, which allows the chip to be identified as a SAM device implementing a DSU. The DSU contains identification registers to differentiate the device.

### 14.10.1 CoreSight Identification

A system-level ARM CoreSight ROM table is present in the device to identify the vendor and the chip identification method. Its address is provided in the MEM-AP BASE register inside the ARM Debug Access Port. The CoreSight ROM implements a 64-bit conceptual ID composed as follows from the PID0 to PID7 CoreSight ROM Table registers:

**Figure 14-5. Conceptual 64-bit Peripheral ID**



**Table 14-2. Conceptual 64-Bit Peripheral ID Bit Descriptions**

Field	Size	Description	Location
JEP-106 CC code	4	Continuation code: 0x0	PID4
JEP-106 ID code	7	Device ID: 0x1F	PID1+PID2
4KB count	4	Indicates that the CoreSight component is a ROM: 0x0	PID4
RevAnd	4	Not used; read as 0	PID3
CUSMOD	4	Not used; read as 0	PID3
PARTNUM	12	Contains 0xCD0 to indicate that DSU is present	PID0+PID1
REVISION	4	DSU revision (starts at 0x0 and increments by 1 at both major and minor revisions). Identifies DSU identification method	PID3

Field	Size	Description	Location
		variants. If 0x0, this indicates that device identification can be completed by reading the Device Identification register (DID)	

For more information, refer to the ARM Debug Interface Version 5 Architecture Specification.

## 14.10.2 Chip Identification Method

The DSU DID register identifies the device by implementing the following information:

- Processor identification
- Product family identification
- Product series identification
- Device select

## 14.11 Functional Description

### 14.11.1 Principle of Operation

The DSU provides memory services such as CRC32 or MBIST that require almost the same interface. Hence, the Address, Length and Data registers (ADDR, LENGTH, DATA) are shared. These shared registers must be configured first; then a command can be issued by writing the Control register. When a command is ongoing, other commands are discarded until the current operation is completed. Hence, the user must wait for the STATUSA.DONE bit to be set prior to issuing another one.

### 14.11.2 Basic Operation

#### 14.11.2.1 Initialization

The module is enabled by enabling its clocks. For more details, refer to [Clocks](#). The DSU registers can be PAC write-protected.

#### Related Links

[PAC - Peripheral Access Controller](#)

#### 14.11.2.2 Operation From a Debug Adapter

Debug adapters should access the DSU registers in the external address range 0x100 – 0x2000. If the device is protected by the NVMCTRL security bit, accessing the first 0x100 bytes causes the system to return an error. Refer to [Intellectual Property Protection](#).

#### Related Links

[NVMCTRL – Non-Volatile Memory Controller Security Bit](#)

#### 14.11.2.3 Operation From the CPU

There are no restrictions when accessing DSU registers from the CPU. However, the user should access DSU registers in the internal address range (0x0 – 0x100) to avoid external security restrictions. Refer to [Intellectual Property Protection](#).

### 14.11.3 32-bit Cyclic Redundancy Check CRC32

The DSU unit provides support for calculating a cyclic redundancy check (CRC32) value for a memory area (including Flash and AHB RAM).

When the CRC32 command is issued from:

- The internal range, the CRC32 can be operated at any memory location
- The external range, the CRC32 operation is restricted; DATA, ADDR, and LENGTH values are forced (see below)

**Table 14-3. AMOD Bit Descriptions when Operating CRC32**

AMOD[1:0]	Short name	External range restrictions
0	ARRAY	CRC32 is restricted to the full Flash array area (EEPROM emulation area not included) DATA forced to 0xFFFFFFFF before calculation (no seed)
1	EEPROM	CRC32 of the whole EEPROM emulation area DATA forced to 0xFFFFFFFF before calculation (no seed)
2-3	Reserved	

The algorithm employed is the industry standard CRC32 algorithm using the generator polynomial 0xEDB88320 (reversed representation).

### 14.11.3.1 Starting CRC32 Calculation

CRC32 calculation for a memory range is started after writing the start address into the Address register (ADDR) and the size of the memory range into the Length register (LENGTH). Both must be word-aligned.

The initial value used for the CRC32 calculation must be written to the Data register (DATA). This value will usually be 0xFFFFFFFF, but can be, for example, the result of a previous CRC32 calculation if generating a common CRC32 of separate memory blocks.

Once completed, the calculated CRC32 value can be read out of the Data register. The read value must be complemented to match standard CRC32 implementations or kept non-inverted if used as starting point for subsequent CRC32 calculations.

If the device is in protected state by the NVMCTRL security bit, it is only possible to calculate the CRC32 of the whole flash array when operated from the external address space. In most cases, this area will be the entire onboard non-volatile memory. The Address, Length and Data registers will be forced to predefined values once the CRC32 operation is started, and values written by the user are ignored. This allows the user to verify the contents of a protected device.

The actual test is started by writing a '1' in the 32-bit Cyclic Redundancy Check bit of the Control register (CTRL.CRC). A running CRC32 operation can be canceled by resetting the module (writing '1' to CTRL.SWRST).

#### Related Links

[NVMCTRL – Non-Volatile Memory Controller Security Bit](#)

### 14.11.3.2 Interpreting the Results

The user should monitor the Status A register. When the operation is completed, STATUSA.DONE is set. Then the Bus Error bit of the Status A register (STATUSA.BERR) must be read to ensure that no bus error occurred.

### 14.11.4 Debug Communication Channels

The Debug Communication Channels (DCC0 and DCC1) consist of a pair of registers with associated handshake logic, accessible by both CPU and debugger even if the device is protected by the NVMCTRL security bit. The registers can be used to exchange data between the CPU and the debugger, during run

time as well as in debug mode. This enables the user to build a custom debug protocol using only these registers.

The DCC0 and DCC1 registers are accessible when the protected state is active. When the device is protected, however, it is not possible to connect a debugger while the CPU is running (STATUSA.CRSTEXT is not writable and the CPU is held under Reset).

Two Debug Communication Channel status bits in the Status B registers (STATUS.DCCDx) indicate whether a new value has been written in DCC0 or DCC1. These bits, DCC0D and DCC1D, are located in the STATUSB registers. They are automatically set on write and cleared on read.

**Note:** The DCC0 and DCC1 registers are shared with the on-board memory testing logic (MBIST). Accordingly, DCC0 and DCC1 must not be used while performing MBIST operations.

## Related Links

[NVMCTRL – Non-Volatile Memory Controller Security Bit](#)

### 14.11.5 Testing of On-Board Memories MBIST

The DSU implements a feature for automatic testing of memory also known as MBIST (memory built-in self test). This is primarily intended for production test of on-board memories. MBIST cannot be operated from the external address range when the device is protected by the NVMCTRL security bit. If an MBIST command is issued when the device is protected, a protection error is reported in the Protection Error bit in the Status A register (STATUSA.PERR).

#### 1. Algorithm

The algorithm used for testing is a type of March algorithm called "March LR". This algorithm is able to detect a wide range of memory defects, while still keeping a linear run time. The algorithm is:

- 1.1. Write entire memory to '0', in any order.
- 1.2. Bit for bit read '0', write '1', in descending order.
- 1.3. Bit for bit read '1', write '0', read '0', write '1', in ascending order.
- 1.4. Bit for bit read '1', write '0', in ascending order.
- 1.5. Bit for bit read '0', write '1', read '1', write '0', in ascending order.
- 1.6. Read '0' from entire memory, in ascending order.

The specific implementation used has a run time which depends on the CPU clock frequency and the number of bytes tested in the RAM. The detected faults are:

- Address decoder faults
- Stuck-at faults
- Transition faults
- Coupling faults
- Linked Coupling faults

#### 2. Starting MBIST

To test a memory, you need to write the start address of the memory to the ADDR.ADDR bit field, and the size of the memory into the Length register.

For best test coverage, an entire physical memory block should be tested at once. It is possible to test only a subset of a memory, but the test coverage will then be somewhat lower.

The actual test is started by writing a '1' to CTRL.MBIST. A running MBIST operation can be canceled by writing a '1' to CTRL.SWRST.

#### 3. Interpreting the Results

The tester should monitor the STATUSA register. When the operation is completed, STATUSA.DONE is set. There are two different modes:

- ADDR.AMOD=0: exit-on-error (default)  
In this mode, the algorithm terminates either when a fault is detected or on successful completion. In both cases, STATUSA.DONE is set. If an error was detected, STATUSA.FAIL will be set. User then can read the DATA and ADDR registers to locate the fault.
- ADDR.AMOD=1: pause-on-error  
In this mode, the MBIST algorithm is paused when an error is detected. In such a situation, only STATUSA.FAIL is asserted. The state machine waits for user to clear STATUSA.FAIL by writing a '1' in STATUSA.FAIL to resume. Prior to resuming, user can read the DATA and ADDR registers to locate the fault.

#### 4. Locating Faults

If the test stops with STATUSA.FAIL set, one or more bits failed the test. The test stops at the first detected error. The position of the failing bit can be found by reading the following registers:

- ADDR: Address of the word containing the failing bit
- DATA: contains data to identify which bit failed, and during which phase of the test it failed. The DATA register will in this case contains the following bit groups:

**Figure 14-6. DATA bits Description When MBIST Operation Returns an Error**



- bit\_index: contains the bit number of the failing bit
- phase: indicates which phase of the test failed and the cause of the error, as listed in the following table.

**Table 14-4. MBIST Operation Phases**

Phase	Test actions
0	Write all bits to zero. This phase cannot fail.
1	Read '0', write '1', increment address
2	Read '1', write '0'
3	Read '0', write '1', decrement address
4	Read '1', write '0', decrement address
5	Read '0', write '1'

Phase	Test actions
6	Read '1', write '0', decrement address
7	Read all zeros. bit_index is not used

**Table 14-5. AMOD Bit Descriptions for MBIST**

AMOD[1:0]	Description
0x0	Exit on Error
0x1	Pause on Error
0x2, 0x3	Reserved

**Related Links**

[NVMCTRL – Non-Volatile Memory Controller](#)

[Security Bit](#)

[Product Mapping](#)

**14.11.6 System Services Availability when Accessed Externally and Device is Protected**

External access: Access performed in the DSU address offset 0x200-0x1FFF range.

Internal access: Access performed in the DSU address offset 0x000-0x100 range.

**Table 14-6. Available Features when Operated From The External Address Range and Device is Protected**

Features	Availability From The External Address Range and Device is Protected
Chip-Erase command and status	Yes
CRC32	Yes, only full array or full EEPROM
CoreSight Compliant Device identification	Yes
Debug communication channels	Yes
Testing of onboard memories (MBIST)	No
STATUSA.CRSTEXT clearing	No (STATUSA.PERR is set when attempting to do so)



## 14.12 Register Summary

Offset	Name	Bit Pos.									
0x00	CTRL	7:0				CE	MBIST		CRC	SWRST	
0x01	STATUSA	7:0				PERR	FAIL	BERR	CRSTEXT	DONE	
0x02	STATUSB	7:0				HPE	DCCDx	DCCDx	DBGPRES	PROT	
0x03	Reserved										
0x04	ADDR	7:0	ADDR[5:0]						AMOD[1:0]		
0x05		15:8	ADDR[13:6]								
0x06		23:16	ADDR[21:14]								
0x07		31:24	ADDR[29:22]								
0x08	LENGTH	7:0	LENGTH[5:0]								
0x09		15:8	LENGTH[13:6]								
0x0A		23:16	LENGTH[21:14]								
0x0B		31:24	LENGTH[29:22]								
0x0C	DATA	7:0	DATA[7:0]								
0x0D		15:8	DATA[15:8]								
0x0E		23:16	DATA[23:16]								
0x0F		31:24	DATA[31:24]								
0x10	DCC0	7:0	DATA[7:0]								
0x11		15:8	DATA[15:8]								
0x12		23:16	DATA[23:16]								
0x13		31:24	DATA[31:24]								
0x14	DCC1	7:0	DATA[7:0]								
0x15		15:8	DATA[15:8]								
0x16		23:16	DATA[23:16]								
0x17		31:24	DATA[31:24]								
0x18	DID	7:0	DEVSEL[7:0]								
0x19		15:8	DIE[3:0]				REVISION[3:0]				
0x1A		23:16	FAMILY[0:0]		SERIES[5:0]						
0x1B		31:24	PROCESSOR[3:0]				FAMILY[4:1]				
0x1C ... 0x0FFF	Reserved										
0x1000	ENTRY0	7:0							FMT	EPRES	
0x1001		15:8	ADDOFF[3:0]								
0x1002		23:16	ADDOFF[11:4]								
0x1003		31:24	ADDOFF[19:12]								
0x1004	ENTRY1	7:0							FMT	EPRES	
0x1005		15:8	ADDOFF[3:0]								
0x1006		23:16	ADDOFF[11:4]								
0x1007		31:24	ADDOFF[19:12]								
0x1008	END	7:0	END[7:0]								
0x1009		15:8	END[15:8]								
0x100A		23:16	END[23:16]								
0x100B		31:24	END[31:24]								
0x100C	Reserved										

Offset	Name	Bit Pos.							
...									
0x1FCB									
0x1FCC	MEMTYPE	7:0							SMEMP
0x1FCD		15:8							
0x1FCE		23:16							
0x1FCF		31:24							
0x1FD0	PID4	7:0	FKBC[3:0]			JEPCC[3:0]			
0x1FD1		15:8							
0x1FD2		23:16							
0x1FD3		31:24							
0x1FD4	Reserved								
...									
0x1FDF									
0x1FE0	PID0	7:0	PARTNBL[7:0]						
0x1FE1		15:8							
0x1FE2		23:16							
0x1FE3		31:24							
0x1FE4	PID1	7:0	JEPIDCL[3:0]			PARTNBH[3:0]			
0x1FE5		15:8							
0x1FE6		23:16							
0x1FE7		31:24							
0x1FE8	PID2	7:0	REVISION[3:0]			JEPU	JEPIDCH[2:0]		
0x1FE9		15:8							
0x1FEA		23:16							
0x1FEB		31:24							
0x1FEC	PID3	7:0	REVAND[3:0]			CUSMOD[3:0]			
0x1FED		15:8							
0x1FEE		23:16							
0x1FEF		31:24							
0x1FF0	CID0	7:0	PREAMBLEB0[7:0]						
0x1FF1		15:8							
0x1FF2		23:16							
0x1FF3		31:24							
0x1FF4	CID1	7:0	CCLASS[3:0]			PREAMBLE[3:0]			
0x1FF5		15:8							
0x1FF6		23:16							
0x1FF7		31:24							
0x1FF8	CID2	7:0	PREAMBLEB2[7:0]						
0x1FF9		15:8							
0x1FFA		23:16							
0x1FFB		31:24							
0x1FFC	CID3	7:0	PREAMBLEB3[7:0]						
0x1FFD		15:8							
0x1FFE		23:16							
0x1FFF		31:24							

## 14.13 Register Description

Registers can be 8, 16, or 32 bits wide. Atomic 8-, 16- and 32-bit accesses are supported. In addition, the 8-bit quarters and 16-bit halves of a 32-bit register, and the 8-bit halves of a 16-bit register can be accessed directly.

Some registers are optionally write-protected by the Peripheral Access Controller (PAC). Optional PAC write-protection is denoted by the "PAC Write-Protection" property in each individual register description. For details, refer to [Register Access Protection](#).

### 14.13.1 Control

**Name:** CTRL  
**Offset:** 0x0000 [ID-00001c14]  
**Reset:** 0x00  
**Property:** PAC Write-Protection

	7	6	5	4	3	2	1	0
Bit				CE	MBIST			SWRST
Access				W	W			W
Reset				0	0			0

#### Bit 4 – CE: Chip-Erase

Writing a '0' to this bit has no effect.

Writing a '1' to this bit starts the Chip-Erase operation.

#### Bit 3 – MBIST: Memory Built-In Self-Test

Writing a '0' to this bit has no effect.

Writing a '1' to this bit starts the memory BIST algorithm.

#### Bit 1 – CRC: 32-bit Cyclic Redundancy Check

Writing a '0' to this bit has no effect.

Writing a '1' to this bit starts the cyclic redundancy check algorithm.

#### Bit 0 – SWRST: Software Reset

Writing a '0' to this bit has no effect.

Writing a '1' to this bit resets the module.

### 14.13.2 Status A

**Name:** STATUSA  
**Offset:** 0x0001 [ID-00001c14]  
**Reset:** 0x00  
**Property:** PAC Write-Protection

Bit	7	6	5	4	3	2	1	0
				PERR	FAIL	BERR	CRSTEXT	DONE
Access				R/W	R/W	R/W	R/W	R/W
Reset				0	0	0	0	0

**Bit 4 – PERR: Protection Error**

Writing a '0' to this bit has no effect.

Writing a '1' to this bit clears the Protection Error bit.

This bit is set when a command that is not allowed in protected state is issued.

**Bit 3 – FAIL: Failure**

Writing a '0' to this bit has no effect.

Writing a '1' to this bit clears the Failure bit.

This bit is set when a DSU operation failure is detected.

**Bit 2 – BERR: Bus Error**

Writing a '0' to this bit has no effect.

Writing a '1' to this bit clears the Bus Error bit.

This bit is set when a bus error is detected.

**Bit 1 – CRSTEXT: CPU Reset Phase Extension**

Writing a '0' to this bit has no effect.

Writing a '1' to this bit clears the CPU Reset Phase Extension bit.

This bit is set when a debug adapter Cold-Plugging is detected, which extends the CPU reset phase.

**Bit 0 – DONE: Done**

Writing a '0' to this bit has no effect.

Writing a '1' to this bit clears the Done bit.

This bit is set when a DSU operation is completed.

### 14.13.3 Status B

**Name:** STATUSB

**Offset:** 0x0002 [ID-00001c14]

**Reset:** 0x1X

**Property:** PAC Write-Protection

Bit	7	6	5	4	3	2	1	0
				HPE	DCCDx	DCCDx	DBGPRES	PROT
Access				R	R	R	R	R
Reset				1	0	0	x	x

**Bit 4 – HPE: Hot-Plugging Enable**

Writing a '0' to this bit has no effect.

Writing a '1' to this bit has no effect.

This bit is set when Hot-Plugging is enabled.

This bit is cleared when Hot-Plugging is disabled. This is the case when the SWCLK function is changed. Only a power-reset or a external reset can set it again.

### **Bits 3,2 – DCCDx: Debug Communication Channel x Dirty [x=1..0]**

Writing a '0' to this bit has no effect.

Writing a '1' to this bit has no effect.

This bit is set when DCCx is written.

This bit is cleared when DCCx is read.

### **Bit 1 – DBGPRES: Debugger Present**

Writing a '0' to this bit has no effect.

Writing a '1' to this bit has no effect.

This bit is set when a debugger probe is detected.

This bit is never cleared.

### **Bit 0 – PROT: Protected**

Writing a '0' to this bit has no effect.

Writing a '1' to this bit has no effect.

This bit is set at power-up when the device is protected.

This bit is never cleared.

## **14.13.4 Address**

**Name:** ADDR

**Offset:** 0x0004 [ID-00001c14]

**Reset:** 0x00000000

**Property:** PAC Write-Protection

Bit	31	30	29	28	27	26	25	24
	ADDR[29:22]							
Access	R/W	R/W	R/W	R/W	R/W	R/W	R/W	R/W
Reset	0	0	0	0	0	0	0	0
Bit	23	22	21	20	19	18	17	16
	ADDR[21:14]							
Access	R/W	R/W	R/W	R/W	R/W	R/W	R/W	R/W
Reset	0	0	0	0	0	0	0	0
Bit	15	14	13	12	11	10	9	8
	ADDR[13:6]							
Access	R/W	R/W	R/W	R/W	R/W	R/W	R/W	R/W
Reset	0	0	0	0	0	0	0	0
Bit	7	6	5	4	3	2	1	0
	ADDR[5:0]						AMOD[1:0]	
Access	R/W	R/W	R/W	R/W	R/W	R/W	R/W	R/W
Reset	0	0	0	0	0	0	0	0

**Bits 31:2 – ADDR[29:0]: Address**

Initial word start address needed for memory operations.

**Bits 1:0 – AMOD[1:0]: Access Mode**

The functionality of these bits is dependent on the operation mode.

Bit description when operating CRC32: refer to [32-bit Cyclic Redundancy Check CRC32](#)

Bit description when testing onboard memories (MBIST): refer to [Testing of On-Board Memories MBIST](#)

### 14.13.5 Length

**Name:** LENGTH

**Offset:** 0x0008 [ID-00001c14]

**Reset:** 0x00000000

**Property:** PAC Write-Protection

Bit	31	30	29	28	27	26	25	24
LENGTH[29:22]								
Access	R/W	R/W	R/W	R/W	R/W	R/W	R/W	R/W
Reset	0	0	0	0	0	0	0	0
Bit	23	22	21	20	19	18	17	16
LENGTH[21:14]								
Access	R/W	R/W	R/W	R/W	R/W	R/W	R/W	R/W
Reset	0	0	0	0	0	0	0	0
Bit	15	14	13	12	11	10	9	8
LENGTH[13:6]								
Access	R/W	R/W	R/W	R/W	R/W	R/W	R/W	R/W
Reset	0	0	0	0	0	0	0	0
Bit	7	6	5	4	3	2	1	0
LENGTH[5:0]								
Access	R/W	R/W	R/W	R/W	R/W	R/W		
Reset	0	0	0	0	0	0		

**Bits 31:2 – LENGTH[29:0]: Length**  
 Length in words needed for memory operations.

### 14.13.6 Data

**Name:** DATA  
**Offset:** 0x000C [ID-00001c14]  
**Reset:** 0x00000000  
**Property:** PAC Write-Protection

Bit	31	30	29	28	27	26	25	24
DATA[31:24]								
Access	R/W	R/W	R/W	R/W	R/W	R/W	R/W	R/W
Reset	0	0	0	0	0	0	0	0
Bit	23	22	21	20	19	18	17	16
DATA[23:16]								
Access	R/W	R/W	R/W	R/W	R/W	R/W	R/W	R/W
Reset	0	0	0	0	0	0	0	0
Bit	15	14	13	12	11	10	9	8
DATA[15:8]								
Access	R/W	R/W	R/W	R/W	R/W	R/W	R/W	R/W
Reset	0	0	0	0	0	0	0	0
Bit	7	6	5	4	3	2	1	0
DATA[7:0]								
Access	R/W	R/W	R/W	R/W	R/W	R/W	R/W	R/W
Reset	0	0	0	0	0	0	0	0

**Bits 31:0 – DATA[31:0]: Data**

Memory operation initial value or result value.

### 14.13.7 Debug Communication Channel 0

**Name:** DCC0  
**Offset:** 0x0010 [ID-00001c14]  
**Reset:** 0x00000000  
**Property:** -



Bit	31	30	29	28	27	26	25	24
DATA[31:24]								
Access	R/W	R/W	R/W	R/W	R/W	R/W	R/W	R/W
Reset	0	0	0	0	0	0	0	0
Bit	23	22	21	20	19	18	17	16
DATA[23:16]								
Access	R/W	R/W	R/W	R/W	R/W	R/W	R/W	R/W
Reset	0	0	0	0	0	0	0	0
Bit	15	14	13	12	11	10	9	8
DATA[15:8]								
Access	R/W	R/W	R/W	R/W	R/W	R/W	R/W	R/W
Reset	0	0	0	0	0	0	0	0
Bit	7	6	5	4	3	2	1	0
DATA[7:0]								
Access	R/W	R/W	R/W	R/W	R/W	R/W	R/W	R/W
Reset	0	0	0	0	0	0	0	0

**Bits 31:0 – DATA[31:0]: Data**

Data register.

### 14.13.8 Debug Communication Channel 1

**Name:** DCC1

**Offset:** 0x0014 [ID-00001c14]

**Reset:** 0x00000000

**Property:** -

Bit	31	30	29	28	27	26	25	24
DATA[31:24]								
Access	R/W	R/W	R/W	R/W	R/W	R/W	R/W	R/W
Reset	0	0	0	0	0	0	0	0
Bit	23	22	21	20	19	18	17	16
DATA[23:16]								
Access	R/W	R/W	R/W	R/W	R/W	R/W	R/W	R/W
Reset	0	0	0	0	0	0	0	0
Bit	15	14	13	12	11	10	9	8
DATA[15:8]								
Access	R/W	R/W	R/W	R/W	R/W	R/W	R/W	R/W
Reset	0	0	0	0	0	0	0	0
Bit	7	6	5	4	3	2	1	0
DATA[7:0]								
Access	R/W	R/W	R/W	R/W	R/W	R/W	R/W	R/W
Reset	0	0	0	0	0	0	0	0

**Bits 31:0 – DATA[31:0]: Data**

Data register.

**14.13.9 Device Identification**

The information in this register is related to the *Ordering Information*.

- Name:** DID
- Offset:** 0x0018 [ID-00001c14]
- Reset:** see related links
- Property:** PAC Write-Protection

Bit	31	30	29	28	27	26	25	24
	PROCESSOR[3:0]				FAMILY[4:1]			
Access	R	R	R	R	R	R	R	R
Reset	p	p	p	p	f	f	f	f
Bit	23	22	21	20	19	18	17	16
	FAMILY[0:0]		SERIES[5:0]					
Access	R		R	R	R	R	R	R
Reset	f		s	s	s	s	s	s
Bit	15	14	13	12	11	10	9	8
	DIE[3:0]				REVISION[3:0]			
Access	R	R	R	R	R	R	R	R
Reset	d	d	d	d	r	r	r	r
Bit	7	6	5	4	3	2	1	0
	DEVSEL[7:0]							
Access	R	R	R	R	R	R	R	R
Reset	x	x	x	x	x	x	x	x

**Bits 31:28 – PROCESSOR[3:0]: Processor**

The value of this field defines the processor used on the device.

**Bits 27:23 – FAMILY[4:0]: Product Family**

The value of this field corresponds to the Product Family part of the ordering code.

**Bits 21:16 – SERIES[5:0]: Product Series**

The value of this field corresponds to the Product Series part of the ordering code.

**Bits 15:12 – DIE[3:0]: Die Number**

Identifies the die family.

**Bits 11:8 – REVISION[3:0]: Revision Number**

Identifies the die revision number. 0x0=rev.A, 0x1=rev.B etc.

**Note:** The device variant (last letter of the ordering number) is independent of the die revision (DSU.DID.REVISION): The device variant denotes functional differences, whereas the die revision marks evolution of the die.

**Bits 7:0 – DEVSEL[7:0]: Device Selection**

This bit field identifies a device within a product family and product series. Refer to the Ordering Information for device configurations and corresponding values for Flash memory density, pin count and device variant.

### 14.13.10 CoreSight ROM Table Entry 0

**Name:** ENTRY0  
**Offset:** 0x1000 [ID-00001c14]  
**Reset:** 0xXXXXXX00X  
**Property:** PAC Write-Protection

Bit	31	30	29	28	27	26	25	24
	ADDOFF[19:12]							
Access	R	R	R	R	R	R	R	R
Reset	x	x	x	x	x	x	x	x
Bit	23	22	21	20	19	18	17	16
	ADDOFF[11:4]							
Access	R	R	R	R	R	R	R	R
Reset	x	x	x	x	x	x	x	x
Bit	15	14	13	12	11	10	9	8
	ADDOFF[3:0]							
Access	R	R	R	R				
Reset	x	x	x	x				
Bit	7	6	5	4	3	2	1	0
							FMT	EPRES
Access							R	R
Reset							1	x

**Bits 31:12 – ADDOFF[19:0]: Address Offset**

The base address of the component, relative to the base address of this ROM table.

**Bit 1 – FMT: Format**

Always reads as '1', indicating a 32-bit ROM table.

**Bit 0 – EPRES: Entry Present**

This bit indicates whether an entry is present at this location in the ROM table.

This bit is set at power-up if the device is not protected indicating that the entry is not present.

This bit is cleared at power-up if the device is not protected indicating that the entry is present.

**14.13.11 CoreSight ROM Table Entry 1**

**Name:** ENTRY1

**Offset:** 0x1004 [ID-00001c14]

**Reset:** 0XXXXXX00X

**Property:** PAC Write-Protection

Bit	31	30	29	28	27	26	25	24
	ADDOFF[19:12]							
Access	R	R	R	R	R	R	R	R
Reset	x	x	x	x	x	x	x	x
Bit	23	22	21	20	19	18	17	16
	ADDOFF[11:4]							
Access	R	R	R	R	R	R	R	R
Reset	x	x	x	x	x	x	x	x
Bit	15	14	13	12	11	10	9	8
	ADDOFF[3:0]							
Access	R	R	R	R				
Reset	x	x	x	x				
Bit	7	6	5	4	3	2	1	0
							FMT	EPRES
Access							R	R
Reset							1	x

**Bits 31:12 – ADDOFF[19:0]: Address Offset**

The base address of the component, relative to the base address of this ROM table.

**Bit 1 – FMT: Format**

Always read as '1', indicating a 32-bit ROM table.

**Bit 0 – EPRES: Entry Present**

This bit indicates whether an entry is present at this location in the ROM table.

This bit is set at power-up if the device is not protected indicating that the entry is not present.

This bit is cleared at power-up if the device is not protected indicating that the entry is present.

**14.13.12 CoreSight ROM Table End**

**Name:** END  
**Offset:** 0x1008 [ID-00001c14]  
**Reset:** 0x00000000  
**Property:** -

Bit	31	30	29	28	27	26	25	24
	END[31:24]							
Access	R	R	R	R	R	R	R	R
Reset	0	0	0	0	0	0	0	0
Bit	23	22	21	20	19	18	17	16
	END[23:16]							
Access	R	R	R	R	R	R	R	R
Reset	0	0	0	0	0	0	0	0
Bit	15	14	13	12	11	10	9	8
	END[15:8]							
Access	R	R	R	R	R	R	R	R
Reset	0	0	0	0	0	0	0	0
Bit	7	6	5	4	3	2	1	0
	END[7:0]							
Access	R	R	R	R	R	R	R	R
Reset	0	0	0	0	0	0	0	0

**Bits 31:0 – END[31:0]: End Marker**  
 Indicates the end of the CoreSight ROM table entries.

### 14.13.13 CoreSight ROM Table Memory Type

**Name:** MEMTYPE  
**Offset:** 0x1FCC [ID-00001c14]  
**Reset:** 0x0000000X  
**Property:** -



**Bit 0 – SMEMP: System Memory Present**

This bit indicates whether system memory is present on the bus that connects to the ROM table.

This bit is set at power-up if the device is not protected, indicating that the system memory is accessible from a debug adapter.

This bit is cleared at power-up if the device is protected, indicating that the system memory is not accessible from a debug adapter.

**14.13.14 Peripheral Identification 4**

**Name:** PID4  
**Offset:** 0x1FD0 [ID-00001c14]  
**Reset:** 0x00000000  
**Property:** -

	Bit	31	30	29	28	27	26	25	24
Access									
Reset									
	Bit	23	22	21	20	19	18	17	16
Access									
Reset									
	Bit	15	14	13	12	11	10	9	8
Access									
Reset									
	Bit	7	6	5	4	3	2	1	0
		FKBC[3:0]				JEPCC[3:0]			
Access		R	R	R	R	R	R	R	R
Reset		0	0	0	0	0	0	0	0

**Bits 7:4 – FKBC[3:0]: 4KB Count**

These bits will always return zero when read, indicating that this debug component occupies one 4KB block.

**Bits 3:0 – JEPCC[3:0]: JEP-106 Continuation Code**

These bits will always return zero when read.

**14.13.15 Peripheral Identification 0**

**Name:** PID0  
**Offset:** 0x1FE0 [ID-00001c14]  
**Reset:** 0x00000000  
**Property:** -



Bit	31	30	29	28	27	26	25	24
Access								
Reset								
Bit	23	22	21	20	19	18	17	16
Access								
Reset								
Bit	15	14	13	12	11	10	9	8
Access								
Reset								
Bit	7	6	5	4	3	2	1	0
	PARTNBL[7:0]							
Access	R	R	R	R	R	R	R	R
Reset	0	0	0	0	0	0	0	0

**Bits 7:0 – PARTNBL[7:0]: Part Number Low**

These bits will always return 0xD0 when read, indicating that this device implements a DSU module instance.

**14.13.16 Peripheral Identification 1**

**Name:** PID1  
**Offset:** 0x1FE4 [ID-00001c14]  
**Reset:** 0x000000FC  
**Property:** -

Bit	31	30	29	28	27	26	25	24
Access								
Reset								
Bit	23	22	21	20	19	18	17	16
Access								
Reset								
Bit	15	14	13	12	11	10	9	8
Access								
Reset								
Bit	7	6	5	4	3	2	1	0
	JEPIDCL[3:0]				PARTNBH[3:0]			
Access	R	R	R	R	R	R	R	R
Reset	1	1	1	1	1	1	0	0

**Bits 7:4 – JEPIDCL[3:0]: Low part of the JEP-106 Identity Code**  
 These bits will always return 0xF when read (JEP-106 identity code is 0x1F).

**Bits 3:0 – PARTNBH[3:0]: Part Number High**  
 These bits will always return 0xC when read, indicating that this device implements a DSU module instance.

### 14.13.17 Peripheral Identification 2

**Name:** PID2  
**Offset:** 0x1FE8 [ID-00001c14]  
**Reset:** 0x00000009  
**Property:** -

Bit	31	30	29	28	27	26	25	24
Access								
Reset								
Bit	23	22	21	20	19	18	17	16
Access								
Reset								
Bit	15	14	13	12	11	10	9	8
Access								
Reset								
Bit	7	6	5	4	3	2	1	0
	REVISION[3:0]				JEPU		JEPIDCH[2:0]	
Access	R	R	R	R	R	R	R	R
Reset	0	0	0	0	1	0	0	1

**Bits 7:4 – REVISION[3:0]: Revision Number**

Revision of the peripheral. Starts at 0x0 and increments by one at both major and minor revisions.

**Bit 3 – JEPU: JEP-106 Identity Code is used**

This bit will always return one when read, indicating that JEP-106 code is used.

**Bits 2:0 – JEPIDCH[2:0]: JEP-106 Identity Code High**

These bits will always return 0x1 when read, (JEP-106 identity code is 0x1F).

**14.13.18 Peripheral Identification 3**

**Name:** PID3  
**Offset:** 0x1FEC [ID-00001c14]  
**Reset:** 0x00000000  
**Property:** -

Bit	31	30	29	28	27	26	25	24
Access								
Reset								
Bit	23	22	21	20	19	18	17	16
Access								
Reset								
Bit	15	14	13	12	11	10	9	8
Access								
Reset								
Bit	7	6	5	4	3	2	1	0
	REVAND[3:0]				CUSMOD[3:0]			
Access	R	R	R	R	R	R	R	R
Reset	0	0	0	0	0	0	0	0

**Bits 7:4 – REVAND[3:0]: Revision Number**  
 These bits will always return 0x0 when read.

**Bits 3:0 – CUSMOD[3:0]: ARM CUSMOD**  
 These bits will always return 0x0 when read.

### 14.13.19 Component Identification 0

**Name:** CID0  
**Offset:** 0x1FF0 [ID-00001c14]  
**Reset:** 0x0000000D  
**Property:** -

Bit	31	30	29	28	27	26	25	24
Access								
Reset								
Bit	23	22	21	20	19	18	17	16
Access								
Reset								
Bit	15	14	13	12	11	10	9	8
Access								
Reset								
Bit	7	6	5	4	3	2	1	0
	PREAMBLEB0[7:0]							
Access	R	R	R	R	R	R	R	R
Reset	0	0	0	0	1	1	0	1

**Bits 7:0 – PREAMBLEB0[7:0]: Preamble Byte 0**  
 These bits will always return 0x0000000D when read.

### 14.13.20 Component Identification 1

**Name:** CID1  
**Offset:** 0x1FF4 [ID-00001c14]  
**Reset:** 0x00000010  
**Property:** -

Bit	31	30	29	28	27	26	25	24
Access								
Reset								
Bit	23	22	21	20	19	18	17	16
Access								
Reset								
Bit	15	14	13	12	11	10	9	8
Access								
Reset								
Bit	7	6	5	4	3	2	1	0
	CCLASS[3:0]				PREAMBLE[3:0]			
Access	R	R	R	R	R	R	R	R
Reset	0	0	0	1	0	0	0	0

**Bits 7:4 – CCLASS[3:0]: Component Class**

These bits will always return 0x1 when read indicating that this ARM CoreSight component is ROM table (refer to the ARM Debug Interface v5 Architecture Specification at <http://www.arm.com>).

**Bits 3:0 – PREAMBLE[3:0]: Preamble**

These bits will always return 0x00 when read.

### 14.13.21 Component Identification 2

**Name:** CID2  
**Offset:** 0x1FF8 [ID-00001c14]  
**Reset:** 0x00000005  
**Property:** -



**Bits 7:0 – PREAMBLEB2[7:0]: Preamble Byte 2**  
 These bits will always return 0x00000005 when read.

### 14.13.22 Component Identification 3

**Name:** CID3  
**Offset:** 0x1FFC [ID-00001c14]  
**Reset:** 0x000000B1  
**Property:** -



**Bits 7:0 – PREAMBLEB3[7:0]: Preamble Byte 3**

These bits will always return 0x000000B1 when read.



## 15. DIVAS – Divide and Square Root Accelerator

### 15.1 Overview

The Divide and Square Root Accelerator (DIVAS) is a programmable 32-bit signed or unsigned hardware divider and a 32-bit unsigned square root hardware engine. The DIVAS is connected to the high-speed bus matrix and may also be accessed using the low-latency CPU local bus (IOBUS; ARM® single-cycle I/O port). The DIVAS takes dividend and divisor values and returns the quotient and remainder when it is used as divider. The DIVAS takes unsigned input value and returns its square root and remainder when it is used as square root function.

### 15.2 Features

- Division accelerator for Cortex-M0+ systems
- 32-bit signed or unsigned integer division
- 32-bit unsigned square root
- 32-bit division in 2-16 cycles
- Programmable leading zero optimization
- Result includes quotient and remainder
- Result includes square root and remainder
- Busy and Divide-by-zero status
- Automatic start of operation when divisor or square root input is loaded

### 15.3 Block Diagram

Figure 15-1. DIVAS Block Diagram



### 15.4 Signal Description

Not applicable

### 15.5 Product Dependencies

In order to use this peripheral, other parts of the system must be configured correctly, as described below.

## 15.5.1 I/O Lines

Not applicable

## 15.5.2 Power Management

The DIVAS will not operate in any sleep mode .

## 15.5.3 Clocks

The DIVAS bus clock (CLK\_DIVAS\_AHB) can be enabled and disabled in the power manager, and the default state of CLK\_DIVAS\_AHB can be found in the Peripheral Clock Masking section in the Power Manager chapter.

## 15.5.4 DMA

Not applicable

## 15.5.5 Interrupts

Not applicable

## 15.5.6 Events

Not applicable

## 15.5.7 Debug Operation

Not applicable

## 15.5.8 Register Access Protection

Certain registers cannot be modified while DIVAS is busy. The following registers are write-protected while busy:

- Control A ([CTRLA](#))
- Dividend ([DIVIDEND](#))
- Divisor ([DIVISOR](#))
- Square Root Input ([SQRNUM](#))

Accessing these registers while protected will result in an error.

## 15.5.9 Analog Connections

Not applicable

## 15.5.10 CPU Local Bus

The CPU local bus (IOBUS) is an interface that connects the CPU directly to the DIVAS. It is a single-cycle bus interface, and does not support wait states. It supports byte, half word and word sizes. This bus is generally used for low latency. All registers can be read and written using this bus.

Since the IOBUS cannot wait for DIVAS to complete operation, the Quotient and Remainder registers must be only be read via the IOBUS while the Busy bit in the Status register (STATUS.BUSY) is zero to prevent incorrect data from being read.

## 15.6 Functional Description

### 15.6.1 Principle of Operation

The Divide and Square Root Accelerator (DIVAS) supports signed or unsigned hardware division of 32-bit values and unsigned square root of 32-bit value. It is accessible from the CPU via both the AHB bus and

IOBUS. When the dividend and divide registers are programmed, the division starts and the result will be stored in the Result and Remainder registers. The Busy and Divide-by-zero status can be read from STATUS register.

When the square root input register (**SQRNUM**) is programmed, the square root function starts and the result will be stored in the Result and Remainder registers. The Busy status can be read from STATUS register.

## 15.6.2 Basic Operation

### 15.6.2.1 Initialization

The DIVAS configuration cannot be modified while a divide operation is ongoing. The following bits must be written prior to starting a division:

- Sign selection bit in Control A register (**CTRLA.SIGNED**)
- Leading zero mode bit in Control A register (**CTRLA.DLZ**)

### 15.6.2.2 Performing Division

First write the dividend to DIVIDEND register. Writing the divisor to DIVISOR register starts the division and sets the busy bit in the Status register (**STATUS.BUSY**). When the division has completed, the **STATUS.BUSY** bit is cleared and the result will be stored in **RESULT** and **REMAINDER** registers.

The **RESULT** and **REMAINDER** registers can be read directly via the high-speed bus without checking first **STATUS.BUSY**. Wait states will be inserted on the high-speed bus until the operation is complete. The IOBUS does not support wait states. For accesses via the IOBUS, the **STATUS.BUSY** bit must be polled before reading the result from the **RESULT** and **REMAINDER** registers.

### 15.6.2.3 Operand Size

#### Divide

The DIVAS can perform 32-bit signed and unsigned division and the operation follows the equation as below.

$$RESULT[31:0] = DIVIDEND[31:0] / DIVISOR[31:0]$$

$$REMAINDER[31:0] = DIVIDEND[31:0] \% DIVISOR[31:0]$$

DIVAS completes 32-bit division in 2-16 cycles.

#### Square Root

The DIVAS can perform 32-bit unsigned division and the operation follows the equation as below.

$$RESULT[31:0] = \sqrt{SQRNUM[31:0]}$$

$$REMAINDER[31:0] = SQRNUM[31:0] - RESULT[31:0]^2$$

### 15.6.2.4 Signed Division

When **CTRLA.SIGNED** is one, both the input and the result will be in 2's complement format. The results of signed division are such that the remainder and dividend have the same sign and the quotient is negative if the dividend and divisor have opposite signs. 16-bit results are sign extended to 32-bits. Note that when the maximum negative number is divided by the minimum negative number, the resulting quotient overflows the signed integer range and will return the maximum negative number with no indication of the overflow. This occurs for 0x80000000 / 0xFFFFFFFF in 32-bit operation and 0x8000 / 0xFFFF in 16-bit operation.

## 15.6.2.5 Divide By Zero

A divide by zero fault occurs if the DIVISOR is programmed to zero. QUOTIENT will be zero and the REMAINDER is equal to DIVIDEND. Divide by zero sets the Divide-by-zero bit in the Status register (STATUS.DBZ) to one. STATUS.DBZ must be cleared by writing a one to it.

## 15.6.2.6 Leading Zero Optimization

Leading zero optimization can reduce the time it takes to complete a division by skipping leading zeros in the DIVIDEND (or leading ones in signed mode). Leading zero optimization is enabled by default and can be disabled by the Disable Leading Zero bit in the Control A register (CTRLA.DLZ). When CTRLA.DLZ is zero, 16-bit division completes in 2-8 cycles and 32-bit division completes in 2-16 cycles, depending on the dividend value. If deterministic timing is required, setting CTRLA.DLZ to one forces 16-bit division to always take 8 cycles and 32-bit division to always take 16 cycles.

## 15.6.2.7 Unsigned Square Root

When the square root input register ([SQRNUM](#)) is programmed, the square root function starts and the result will be stored in the Result and Remainder registers. The Busy status can be read from STATUS register.

## 15.7 Register Summary

Offset	Name	Bit Pos.								
0x00	<b>CTRLA</b>	7:0							DLZ	SIGNED
0x01	Reserved									
...										
0x03										
0x04	<b>STATUS</b>	7:0							DBZ	BUSY
0x05	Reserved									
...										
0x07										
0x08	<b>DIVIDEND</b>	7:0	DIVIDEND[7:0]							
0x09		15:8	DIVIDEND[15:8]							
0x0A		23:16	DIVIDEND[23:16]							
0x0B		31:24	DIVIDEND[31:24]							
0x0C	<b>DIVISOR</b>	7:0	DIVISOR[7:0]							
0x0D		15:8	DIVISOR[15:8]							
0x0E		23:16	DIVISOR[23:16]							
0x0F		31:24	DIVISOR[31:24]							
0x10	<b>RESULT</b>	7:0	RESULT[7:0]							
0x11		15:8	RESULT[15:8]							
0x12		23:16	RESULT[23:16]							
0x13		31:24	RESULT[31:24]							
0x14	<b>REMAINDER</b>	7:0	REMAINDER[7:0]							
0x15		15:8	REMAINDER[15:8]							
0x16		23:16	REMAINDER[23:16]							
0x17		31:24	REMAINDER[31:24]							
0x18	<b>SQRNUM</b>	7:0	SQRNUM[7:0]							
0x19		15:8	SQRNUM[15:8]							
0x1A		23:16	SQRNUM[23:16]							
0x1B		31:24	SQRNUM[31:24]							

## 15.8 Register Description

Registers can be 8, 16, or 32 bits wide. Atomic 8-, 16-, and 32-bit accesses are supported. In addition, the 8-bit quarters and 16-bit halves of a 32-bit register, and the 8-bit halves of a 16-bit register can be accessed directly.

### 15.8.1 Control A

**Name:** CTRLA  
**Offset:** 0x00  
**Reset:** 0x00  
**Property:** -

Bit	7	6	5	4	3	2	1	0
							DLZ	SIGNED
Access							R/W	R/W
Reset							0	0

### Bit 1 – DLZ: Disable Leading Zero Optimization

Value	Description
0	Enable leading zero optimization; 32-bit division takes 2-16 cycles.
1	Disable leading zero optimization; 32-bit division takes 16 cycles.

### Bit 0 – SIGNED: Signed Division Enable

Value	Description
0	Unsigned division.
1	Signed division.

## 15.8.2 Status

**Name:** STATUS  
**Offset:** 0x04  
**Reset:** 0x00  
**Property:** -

Bit	7	6	5	4	3	2	1	0
							DBZ	BUSY
Access							R/W	R/W
Reset							0	0

### Bit 1 – DBZ: Disable-By-Zero

Writing a zero to this bit has no effect.

Writing a one to this bit clears DBZ to zero.

Value	Description
0	A divide-by-zero fault has not occurred
1	A divide-by-zero fault has occurred

### Bit 0 – BUSY: DIVAS Accelerator Busy

This bit is set when a value is written to the [DIVISOR](#) or [SQRNUM](#) registers.

This bit is cleared when either division or square root function completes and results are ready in the [RESULT](#) and [REMAINDER](#) registers.

Value	Description
0	DIVAS is idle
1	DIVAS is busy with an ongoing division

## 15.8.3 Dividend

**Name:** DIVIDEND  
**Offset:** 0x08  
**Reset:** 0x0000  
**Property:** -

Bit	31	30	29	28	27	26	25	24
DIVIDEND[31:24]								
Access	R/W	R/W	R/W	R/W	R/W	R/W	R/W	R/W
Reset	0	0	0	0	0	0	0	0
Bit	23	22	21	20	19	18	17	16
DIVIDEND[23:16]								
Access	R/W	R/W	R/W	R/W	R/W	R/W	R/W	R/W
Reset	0	0	0	0	0	0	0	0
Bit	15	14	13	12	11	10	9	8
DIVIDEND[15:8]								
Access	R/W	R/W	R/W	R/W	R/W	R/W	R/W	R/W
Reset	0	0	0	0	0	0	0	0
Bit	7	6	5	4	3	2	1	0
DIVIDEND[7:0]								
Access	R/W	R/W	R/W	R/W	R/W	R/W	R/W	R/W
Reset	0	0	0	0	0	0	0	0

**Bits 31:0 – DIVIDEND[31:0]: Dividend Value**

Holds the 32-bit dividend for the divide operation. If the Signed bit in Control A register (CTRLA.SIGNED) is zero, DIVIDEND is unsigned. If CTRLA.SIGNED = 1, DIVIDEND is signed two's complement. Refer to [Performing Division](#), [Operand Size](#) and [Signed Division](#).

### 15.8.4 Divisor

**Name:** DIVISOR  
**Offset:** 0x0C  
**Reset:** 0x0000  
**Property:** -

Bit	31	30	29	28	27	26	25	24
DIVISOR[31:24]								
Access	R/W	R/W	R/W	R/W	R/W	R/W	R/W	R/W
Reset	0	0	0	0	0	0	0	0
Bit	23	22	21	20	19	18	17	16
DIVISOR[23:16]								
Access	R/W	R/W	R/W	R/W	R/W	R/W	R/W	R/W
Reset	0	0	0	0	0	0	0	0
Bit	15	14	13	12	11	10	9	8
DIVISOR[15:8]								
Access	R/W	R/W	R/W	R/W	R/W	R/W	R/W	R/W
Reset	0	0	0	0	0	0	0	0
Bit	7	6	5	4	3	2	1	0
DIVISOR[7:0]								
Access	R/W	R/W	R/W	R/W	R/W	R/W	R/W	R/W
Reset	0	0	0	0	0	0	0	0

**Bits 31:0 – DIVISOR[31:0]: Divisor Value**

Holds the 32-bit divisor for the divide operation. If the Signed bit in Control A register (CTRLA.SIGNED) is zero, DIVISOR is unsigned. If CTRLA.SIGNED = 1, DIVISOR is signed two's complement. Writing the DIVISOR register will start the divide function. Refer to [Performing Division](#), [Operand Size](#) and [Signed Division](#).

**15.8.5 Result**

**Name:** RESULT  
**Offset:** 0x10  
**Reset:** 0x0000  
**Property:** -



Bit	31	30	29	28	27	26	25	24
RESULT[31:24]								
Access	R	R	R	R	R	R	R	R
Reset	0	0	0	0	0	0	0	0
Bit	23	22	21	20	19	18	17	16
RESULT[23:16]								
Access	R	R	R	R	R	R	R	R
Reset	0	0	0	0	0	0	0	0
Bit	15	14	13	12	11	10	9	8
RESULT[15:8]								
Access	R	R	R	R	R	R	R	R
Reset	0	0	0	0	0	0	0	0
Bit	7	6	5	4	3	2	1	0
RESULT[7:0]								
Access	R	R	R	R	R	R	R	R
Reset	0	0	0	0	0	0	0	0

**Bits 31:0 – RESULT[31:0]: Result of Operation**

Holds the 32-bit result of the last performed operation. For a divide operation this is the quotient. If the Signed bit in Control A register (CTRLA.SIGNED) is zero, the quotient is unsigned. If CTRLA.SIGNED = 1, the quotient is signed two's complement. For a square root operation this is the square root. Refer to [Performing Division](#), [Operand Size](#) and [Signed Division](#).

**15.8.6 Remainder**

**Name:** REMAINDER  
**Offset:** 0x14  
**Reset:** 0x0000  
**Property:** -

Bit	31	30	29	28	27	26	25	24
	REMAINDER[31:24]							
Access	R	R	R	R	R	R	R	R
Reset	0	0	0	0	0	0	0	0
Bit	23	22	21	20	19	18	17	16
	REMAINDER[23:16]							
Access	R	R	R	R	R	R	R	R
Reset	0	0	0	0	0	0	0	0
Bit	15	14	13	12	11	10	9	8
	REMAINDER[15:8]							
Access	R	R	R	R	R	R	R	R
Reset	0	0	0	0	0	0	0	0
Bit	7	6	5	4	3	2	1	0
	REMAINDER[7:0]							
Access	R	R	R	R	R	R	R	R
Reset	0	0	0	0	0	0	0	0

**Bits 31:0 – REMAINDER[31:0]: Remainder of Operation**

Holds the 32-bit remainder of the last performed operation. For a divide operation this is the division remainder. If the Signed bit in Control A register (CTRLA.SIGNED) is zero, the quotient is unsigned. If CTRLA.SIGNED = 1, the quotient is signed two's complement. For a square root operation this is the square root remainder. Refer to [Performing Division](#), [Operand Size](#) and [Signed Division](#).

**15.8.7 Square Root Input**

**Name:** SQRNUM  
**Offset:** 0x18  
**Reset:** 0x0000  
**Property:** -

Bit	31	30	29	28	27	26	25	24
SQRNUM[31:24]								
Access	R/W	R/W	R/W	R/W	R/W	R/W	R/W	R/W
Reset	0	0	0	0	0	0	0	0
Bit	23	22	21	20	19	18	17	16
SQRNUM[23:16]								
Access	R/W	R/W	R/W	R/W	R/W	R/W	R/W	R/W
Reset	0	0	0	0	0	0	0	0
Bit	15	14	13	12	11	10	9	8
SQRNUM[15:8]								
Access	R/W	R/W	R/W	R/W	R/W	R/W	R/W	R/W
Reset	0	0	0	0	0	0	0	0
Bit	7	6	5	4	3	2	1	0
SQRNUM[7:0]								
Access	R/W	R/W	R/W	R/W	R/W	R/W	R/W	R/W
Reset	0	0	0	0	0	0	0	0

**Bits 31:0 – SQRNUM[31:0]: Square Root Input**

Holds the 32-bit unsigned input for the square root operation. Writing the SQRNUM register will start the square root function. Refer to [Unsigned Square Root](#).

## 16. Clock System

This chapter only aims to summarize the clock distribution and terminology in the SAM C20 device. It will not explain every detail of its configuration. For in-depth documentation, see the referenced module chapters.

### 16.1 Clock Distribution

Figure 16-1. Clock distribution



The clock system on the SAM C20 consists of:

- Clock sources, controlled by OSCCTRL and OSC32KCTRL
  - A Clock source is the base clock signal used in the system. Example clock sources are the internal 48MHz oscillator (OSC48M), External crystal oscillator (XOSC) and the Digital phase locked loop (FDPLL96M).
- Generic Clock Controller (GCLK) which controls the clock distribution system, made up of:
  - Generic Clock generators: A programmable prescaler, that can use any of the system clock sources as its source clock. The Generic Clock Generator 0, also called GCLK\_MAIN, is the clock feeding the Power Manager used to generate synchronous clocks.
  - Generic Clocks: Typically the clock input of a peripheral on the system. The generic clocks, through the Generic Clock Multiplexer, can use any of the Generic Clock generators as its clock source. Multiple instances of a peripheral will typically have a separate generic clock for each instance.
- Main Clock controller (MCLK)
  - The MCLK controls synchronous clocks on the system. This includes the CPU, bus clocks (APB, AHB) as well as the synchronous (to the CPU) user interfaces of the peripherals. It contains clock masks that can turn on/off the user interface of a peripheral as well as prescalers for the CPU and bus clocks.

The figure below shows an example where SERCOM0 is clocked by the OSC48M. The OSC48M is enabled, the Generic Clock Generator 1 uses the OSCLL48M as its clock source, and the generic clock 19, also called GCLK\_SERCOM0\_CORE, that is connected to SERCOM0 uses generator 1 as its source. The SERCOM0 interface, clocked by CLK\_SERCOM0\_APB, has been unmasked in the APBC Mask register in the MCLK.

**Figure 16-2. Example of SERCOM clock**



## 16.2 Synchronous and Asynchronous Clocks

As the CPU and the peripherals can be clocked from different clock sources, possibly with widely different clock speeds, some peripheral accesses by the CPU needs to be synchronized between the different clock domains. In these cases the peripheral includes a SYNCBUSY status register that can be used to check if a sync operation is in progress. As the nature of the synchronization might vary between different peripherals, detailed description for each peripheral can be found in the sub-chapter “synchronization” for each peripheral where this is necessary.

In the datasheet references to synchronous clocks are referring to the CPU and bus clocks, while asynchronous clocks are clock generated by generic clocks.

## 16.3 Register Synchronization

### 16.3.1 Overview

All peripherals are composed of one digital bus interface, which is connected to the APB or AHB bus and clocked using a corresponding synchronous clock, and one core clock, which is clocked using a generic clock. Access between these clock domains must be synchronized. As this mechanism is implemented in hardware the synchronization process takes place even if the different clocks domains are clocked from the same source and on the same frequency. All registers in the bus interface are accessible without synchronization. All core registers in the generic clock domain must be synchronized when written. Some core registers must be synchronized when read. Registers that need synchronization has this denoted in each individual register description.

### 16.3.2 General Write-Synchronization

Inside the same module, each core register, denoted by the Write-Synchronized property, use its own synchronization mechanism so that writing to different core registers can be done without waiting for the end of synchronization of previous core register access.

However a second write access to the same core register, while synchronization is on going, is discarded and an error is reported through the PAC. To write again to the same core register in the same module, user must wait for the end of synchronization.

For each core register, that can be written, a synchronization status bit is associated

**Example:**

REGA, REGB are 8-bit core registers. REGC is 16-bit core register.

Offset	Register
0x00	REGA
0x01	REGB
0x02	REGC
0x03	

Since synchronization is per register, user can write REGA (8-bit access) then immediately write REGB (8-bit access) without error.

User can write REGC (16-bit access) without affecting REGA or REGB. But if user writes REGC in two consecutive 8-bit accesses, second write will be discarded and generate an error.

When user makes a 32-bit access to offset 0x00, all registers are written but REGA, REGB, REGC can be updated at a different time because of independent write synchronization

### 16.3.3 General Read-Synchronization

Before any read of a core register, the user must check that the related bit in SYNCBUSY register is cleared.

Read access to core register is always immediate but the return value is reliable only if a synchronization of this core register is not going.

### 16.3.4 Completion of Synchronization

The user can either poll SYNCBUSY register or use the Synchronization Ready interrupt (if available) to check when the synchronization is complete.

### 16.3.5 Enable Write-Synchronization

Writing to the Enable bit in the Control register (CTRL.ENABLE) will also trigger write-synchronization and set SYNCBUSY.ENABLE. CTRL.ENABLE will read its new value immediately after being written. The Synchronisation Ready interrupt (if available) cannot be used for Enable write-synchronization.

### 16.3.6 Software Reset Write-Synchronization

Writing a one to the Software Reset bit in CTRL (CTRL.SWRST) will also trigger write-synchronization and set SYNCBUSY.SWRST. When writing a one to the CTRL.SWRST bit it will immediately read as one. CTRL.SWRST and SYNCBUSY.SWRST will be cleared by hardware when the peripheral has been reset. Writing a zero to the CTRL.SWRST bit has no effect. The Synchronisation Ready interrupt (if available) cannot be used for Software Reset write-synchronization.

### 16.3.7 Synchronization Delay

The synchronization will delay the write or read access duration by a delay  $D$ , given by the equation:

$$5 \cdot P_{GCLK} + 2 \cdot P_{APB} < D < 6 \cdot P_{GCLK} + 3 \cdot P_{APB}$$

Where  $P_{GCLK}$  is the period of the generic clock and  $P_{APB}$  is the period of the peripheral bus clock. A normal peripheral bus register access duration is  $2 \cdot P_{APB}$ .

## 16.4 Enabling a Peripheral

To enable a peripheral clocked by a generic clock, the following parts of the system needs to be configured:

- A running clock source.
- A clock from the Generic Clock Generator must be configured to use one of the running clock sources, and the generator must be enabled.
- The generic clock, through the Generic Clock Multiplexer, that connects to the peripheral needs to be configured with a running clock from the Generic Clock Generator, and the generic clock must be enabled.
- The user interface of the peripheral needs to be unmasked in the PM. If this is not done the peripheral registers will read as all 0's and any writes to the peripheral will be discarded.

## 16.5 On-demand, Clock Requests

Figure 16-3. Clock request routing



All the clock sources in the system can be run in an on-demand mode, where the clock source is in a stopped state when no peripherals are requesting the clock source. Clock requests propagate from the peripheral, via the GCLK, to the clock source. If one or more peripheral is using a clock source, the clock source will be started/kept running. As soon as the clock source is no longer needed and no peripheral have an active request the clock source will be stopped until requested again. For the clock request to reach the clock source, the peripheral, the generic clock and the clock from the Generic Clock Generator in-between must be enabled. The time taken from a clock request being asserted to the clock source being ready is dependent on the clock source startup time, clock source frequency as well as the divider used in the Generic Clock Generator. The total startup time from a clock request to the clock is available for the peripheral is:

```

Delay_start_max = Clock source startup time + 2 * clock source periods + 2 * divided clock
source periods
Delay_start_min = Clock source startup time + 1 * clock source period + 1 * divided clock
source period
Delay_start_min = Clock source startup time + 1 * clock source period + 1 *
divided clock source period
  
```

The delay for shutting down the clock source when there is no longer an active request is:

```

Delay_stop_min = 1 * divided clock source period + 1 * clock source period
Delay_stop_max = 2 * divided clock source periods + 2 * clock source periods
  
```

The On-Demand principle can be disabled individually for each clock source by clearing the ONDEMAND bit located in each clock source controller. The clock is always running whatever is the clock request. This has the effect to remove the clock source startup time at the cost of the power consumption.

In standby mode, the clock request mechanism is still working if the modules are configured to run in standby mode (RUNSTDBY bit).

## 16.6 Power Consumption vs. Speed

Due to the nature of the asynchronous clocking of the peripherals there are some considerations that needs to be taken if either targeting a low-power or a fast-acting system. If clocking a peripheral with a very low clock, the active power consumption of the peripheral will be lower. At the same time the synchronization to the synchronous (CPU) clock domain is dependent on the peripheral clock speed, and will be longer with a slower peripheral clock; giving lower response time and more time waiting for the synchronization to complete.

## 16.7 Clocks after Reset

On any reset the synchronous clocks start to their initial state:

- OSC48M is enabled and divided by 12
- GCLK\_MAIN uses OSC48M as source
- CPU and BUS clocks are undivided

On a power reset the GCLK starts to their initial state:

- All generic clock generators disabled except:
  - The generator 0 (GCLK\_MAIN) using OSC48M as source, with no division
- All generic clocks disabled

On a user reset the GCLK starts to their initial state, except for:

- Generic clocks that are write-locked (WRTLOCK is written to one prior to reset)

On any reset the clock sources are reset to their initial state except the 32KHz clock sources which are reset only by a power reset.



## 17. GCLK - Generic Clock Controller

### 17.1 Overview

Depending on the application, peripherals may require specific clock frequencies to operate correctly. The Generic Clock controller (GCLK) features 9 Generic Clock Generators 0..8 that can provide a wide range of clock frequencies.

Generators can be set to use different external and internal oscillators as source. The clock of each Generator can be divided. The outputs from the Generators are used as sources for the Peripheral Channels, which provide the Generic Clock (GCLK\_PERIPH) to the peripheral modules, as shown in [Figure 17-2](#). The number of Peripheral Clocks depends on how many peripherals the device has.

**Note:** The Generator 0 is always the direct source of the GCLK\_MAIN signal.

### 17.2 Features

- Provides a device-defined, configurable number of Peripheral Channel clocks
- Wide frequency range:
  - Various clock sources
  - Embedded dividers

### 17.3 Block Diagram

The generation of Peripheral Clock signals (GCLK\_PERIPH) and the Main Clock (GCLK\_MAIN) can be seen in [Device Clocking Diagram](#).

**Figure 17-1. Device Clocking Diagram**



The GCLK block diagram is shown below:

Figure 17-2. Generic Clock Controller Block Diagram



## 17.4 Signal Description

Table 17-1. GCLK Signal Description

Signal Name	Type	Description
GCLK_IO[3:0]	Digital I/O	Clock source for Generators when input Generic Clock signal when output

**Note:** One signal can be mapped on several pins.

### Related Links

[I/O Multiplexing and Considerations](#)

## 17.5 Product Dependencies

In order to use this peripheral, other parts of the system must be configured correctly, as described below.

### 17.5.1 I/O Lines

Using the GCLK I/O lines requires the I/O pins to be configured.

### Related Links

[PORT - I/O Pin Controller](#)

### 17.5.2 Power Management

The GCLK can operate in sleep modes, if required. Refer to the sleep mode description in the Power Manager (PM) section.

### Related Links

[PM – Power Manager](#)

## 17.5.3 Clocks

The GCLK bus clock (CLK\_GCLK\_APB) can be enabled and disabled in the Main Clock Controller.

### Related Links

[Peripheral Clock Masking](#)

[OSC32KCTRL – 32KHz Oscillators Controller](#)

## 17.5.4 DMA

Not applicable.

## 17.5.5 Interrupts

Not applicable.

## 17.5.6 Events

Not applicable.

## 17.5.7 Debug Operation

When the CPU is halted in debug mode the GCLK continues normal operation. If the GCLK is configured in a way that requires it to be periodically serviced by the CPU through interrupts or similar, improper operation or data loss may result during debugging.

## 17.5.8 Register Access Protection

All registers with write-access can be optionally write-protected by the Peripheral Access Controller (PAC).

**Note:** Optional write-protection is indicated by the "PAC Write-Protection" property in the register description.

When the CPU is halted in debug mode, all write-protection is automatically disabled. Write-protection does not apply for accesses through an external debugger.

### Related Links

[PAC - Peripheral Access Controller](#)

## 17.5.9 Analog Connections

Not applicable.

## 17.6 Functional Description

### 17.6.1 Principle of Operation

The GCLK module is comprised of nine Generic Clock Generators (Generators) sourcing up to 64 Peripheral Channels and the Main Clock signal GCLK\_MAIN.

A clock source selected as input to a Generator can either be used directly, or it can be prescaled in the Generator. A generator output is used by one or more Peripheral Channels to provide a peripheral generic clock signal (GCLK\_PERIPH) to the peripherals.

### 17.6.2 Basic Operation

#### 17.6.2.1 Initialization

Before a Generator is enabled, the corresponding clock source should be enabled. The Peripheral clock must be configured as outlined by the following steps:

1. The Generator must be enabled ( $\text{GENCTRLn.GENEN}=1$ ) and the division factor must be set ( $\text{GENCTRLn.DIVSEL}$  and  $\text{GENCTRLn.DIV}$ ) by performing a single 32-bit write to the Generator Control register ( $\text{GENCTRLn}$ ).
2. The Generic Clock for a peripheral must be configured by writing to the respective Peripheral Channel Control register ( $\text{PCHCTRLm}$ ). The Generator used as the source for the Peripheral Clock must be written to the GEN bit field in the Peripheral Channel Control register ( $\text{PCHCTRLm.GEN}$ ).

**Note:** Each Generator  $n$  is configured by one dedicated register  $\text{GENCTRLn}$ .

**Note:** Each Peripheral Channel  $m$  is configured by one dedicated register  $\text{PCHCTRLm}$ .

### 17.6.2.2 Enabling, Disabling, and Resetting

The GCLK module has no enable/disable bit to enable or disable the whole module.

The GCLK is reset by setting the Software Reset bit in the Control A register ( $\text{CTRLA.SWRST}$ ) to 1. All registers in the GCLK will be reset to their initial state, except for Peripheral Channels and associated Generators that have their Write Lock bit set to 1 ( $\text{PCHCTRLm.WRTLOCK}$ ). For further details, refer to [Configuration Lock](#).

### 17.6.2.3 Generic Clock Generator

Each Generator ( $\text{GCLK\_GEN}$ ) can be set to run from one of nine different clock sources except  $\text{GCLK\_GEN}[1]$ , which can be set to run from one of eight sources.  $\text{GCLK\_GEN}[1]$  is the only Generator that can be selected as source to others Generators.

Each generator  $\text{GCLK\_GEN}[x]$  can be connected to one specific pin  $\text{GCLK\_IO}[x]$ . A pin  $\text{GCLK\_IO}[x]$  can be set either to act as source to  $\text{GCLK\_GEN}[x]$  or to output the clock signal generated by  $\text{GCLK\_GEN}[x]$ .

The selected source can be divided. Each Generator can be enabled or disabled independently.

Each  $\text{GCLK\_GEN}$  clock signal can then be used as clock source for Peripheral Channels. Each Generator output is allocated to one or several Peripherals.

$\text{GCLK\_GEN}[0]$  is used as  $\text{GCLK\_MAIN}$  for the synchronous clock controller inside the Main Clock Controller. Refer to the Main Clock Controller description for details on the synchronous clock generation.

**Figure 17-3. Generic Clock Generator**



#### Related Links

[MCLK – Main Clock](#)

### 17.6.2.4 Enabling a Generator

A Generator is enabled by writing a '1' to the Generator Enable bit in the Generator Control register ( $\text{GENCTRLn.GENEN}=1$ ).

## 17.6.2.5 Disabling a Generator

A Generator is disabled by writing a '0' to GENCTRLn.GENEN. When GENCTRLn.GENEN=0, the GCLK\_GEN[n] clock is disabled and gated.

## 17.6.2.6 Selecting a Clock Source for the Generator

Each Generator can individually select a clock source by setting the Source Select bit group in the Generator Control register (GENCTRLn.SRC).

Changing from one clock source, for example A, to another clock source, B, can be done on the fly: If clock source B is not ready, the Generator will continue using clock source A. As soon as source B is ready, the Generator will switch to it. During the switching operation, the Generator maintains clock requests to both clock sources A and B, and will release source A as soon as the switch is done. The according bit in SYNCBUSY register (SYNCBUSY.GENCTRLn) will remain '1' until the switch operation is completed.

The available clock sources are device dependent (usually the oscillators, RC oscillators, DPLL, and DFLL). Only Generator 1 can be used as a common source for all other generators.

## 17.6.2.7 Changing the Clock Frequency

The selected source for a Generator can be divided by writing a division value in the Division Factor bit field of the Generator Control register (GENCTRLn.DIV). How the actual division factor is calculated is depending on the Divide Selection bit (GENCTRLn.DIVSEL).

If GENCTRLn.DIVSEL=0 and GENCTRLn.DIV is either 0 or 1, the output clock will be undivided.

**Note:** The number of available DIV bits may vary from Generator to Generator.

## 17.6.2.8 Duty Cycle

When dividing a clock with an odd division factor, the duty-cycle will not be 50/50. Setting the Improve Duty Cycle bit of the Generator Control register (GENCTRLn.IDC) will result in a 50/50 duty cycle.

## 17.6.2.9 External Clock

The output clock (GCLK\_GEN) of each Generator can be sent to I/O pins (GCLK\_IO).

If the Output Enable bit in the Generator Control register is set (GENCTRLn.OE = 1) and the generator is enabled (GENCTRLn.GENEN=1), the Generator requests its clock source and the GCLK\_GEN clock is output to an I/O pin.

**Note:** The I/O pin (GCLK\_IO[n]) must first be configured as output by writing the corresponding PORT registers.

If GENCTRLn.OE is 0, the according I/O pin is set to an Output Off Value, which is selected by GENCTRLn.OOV: If GENCTRLn.OOV is '0', the output clock will be low. If this bit is '1', the output clock will be high.

In Standby mode, if the clock is output (GENCTRLn.OE=1), the clock on the I/O pin is frozen to the OOV value if the Run In Standby bit of the Generic Control register (GENCTRLn.RUNSTDBY) is zero. If GENCTRLn.RUNSTDBY is '1', the GCLKGEN clock is kept running and output to the I/O pin.

## 17.6.3 Peripheral Clock

Figure 17-4. Peripheral Clock



### 17.6.3.1 Enabling a Peripheral Clock

Before a Peripheral Clock is enabled, one of the Generators must be enabled (GENCTRLn.GENEN) and selected as source for the Peripheral Channel by setting the Generator Selection bits in the Peripheral Channel Control register (PCHCTRLm.GEN). Any available Generator can be selected as clock source for each Peripheral Channel.

When a Generator has been selected, the peripheral clock is enabled by setting the Channel Enable bit in the Peripheral Channel Control register, PCHCTRLm.CHEN = 1. The PCHCTRLm.CHEN bit must be synchronized to the generic clock domain. PCHCTRLm.CHEN will continue to read as its previous state until the synchronization is complete.

### 17.6.3.2 Disabling a Peripheral Clock

A Peripheral Clock is disabled by writing PCHCTRLm.CHEN=0. The PCHCTRLm.CHEN bit must be synchronized to the Generic Clock domain. PCHCTRLm.CHEN will stay in its previous state until the synchronization is complete. The Peripheral Clock is gated when disabled.

#### Related Links

[PCHCTRLm](#)

### 17.6.3.3 Selecting the Clock Source for a Peripheral

When changing a peripheral clock source by writing to PCHCTRLm.GEN, the peripheral clock must be disabled before re-enabling it with the new clock source setting. This prevents glitches during the transition:

1. Disable the Peripheral Channel by writing PCHCTRLm.CHEN=0
2. Assert that PCHCTRLm.CHEN reads '0'
3. Change the source of the Peripheral Channel by writing PCHCTRLm.GEN
4. Re-enable the Peripheral Channel by writing PCHCTRLm.CHEN=1

#### Related Links

[PCHCTRLm](#)

### 17.6.3.4 Configuration Lock

The peripheral clock configuration can be locked for further write accesses by setting the Write Lock bit in the Peripheral Channel Control register (PCHCTRLm.WRTLOCK=1). All writing to the PCHCTRLm register will be ignored. It can only be unlocked by a Power Reset.

The Generator source of a locked Peripheral Channel will be locked, too: The corresponding GENCTRLn register is locked, and can be unlocked only by a Power Reset.

There is one exception concerning the Generator 0. As it is used as GCLK\_MAIN, it cannot be locked. It is reset by any Reset and will start up in a known configuration. The software reset (CTRLA.SWRST) can not unlock the registers.

In case of an external Reset, the Generator source will be disabled. Even if the WRTLOCK bit is written to '1' the peripheral channels are disabled (PCHCTRLm.CHEN set to '0') until the Generator source is enabled again. Then, the PCHCTRLm.CHEN are set to '1' again.

**Related Links**

[CTRLA](#)

**17.6.4 Additional Features**

**17.6.4.1 Peripheral Clock Enable after Reset**

The Generic Clock Controller must be able to provide a generic clock to some specific peripherals after a Reset. That means that the configuration of the Generators and Peripheral Channels after Reset is device-dependent.

Refer to GENCTRLn.SRC for details on GENCTRLn reset.

Refer to PCHCTRLm.SRC for details on PCHCTRLm reset.

**17.6.5 Sleep Mode Operation**

**17.6.5.1 SleepWalking**

The GCLK module supports the SleepWalking feature.

If the system is in a sleep mode where the Generic Clocks are stopped, a peripheral that needs its clock in order to execute a process must request it from the Generic Clock Controller.

The Generic Clock Controller receives this request, determines which Generic Clock Generator is involved and which clock source needs to be awakened. It then wakes up the respective clock source, enables the Generator and Peripheral Channel stages successively, and delivers the clock to the peripheral.

The RUNSTDBY bit in the Generator Control register controls clock output to pin during standby sleep mode. If the bit is cleared, the Generator output is not available on pin. When set, the GCLK can continuously output the generator output to GCLK\_IO. Refer to [External Clock](#) for details.

**Related Links**

[PM – Power Manager](#)

**17.6.5.2 Minimize Power Consumption in Standby**

The following table identifies when a Clock Generator is off in Standby Mode, minimizing the power consumption:

**Table 17-2. Clock Generator n Activity in Standby Mode**

Request for Clock n present	GENCTRLn.RUNSTDBY	GENCTRLn.OE	Clock Generator n
yes	-	-	active
no	1	1	active
no	1	0	OFF

Request for Clock n present	GENCTRLn.RUNSTDBY	GENCTRLn.OE	Clock Generator n
no	0	1	OFF
no	0	0	OFF

### 17.6.5.3 Entering Standby Mode

There may occur a delay when the device is put into Standby, until the power is turned off. This delay is caused by running Clock Generators: if the Run in Standby bit in the Generator Control register (GENCTRLn.RUNSTDBY) is '0', GCLK must verify that the clock is turned off properly. The duration of this verification is frequency-dependent.

#### Related Links

[PM – Power Manager](#)

### 17.6.6 Synchronization

Due to asynchronicity between the main clock domain and the peripheral clock domains, some registers need to be synchronized when written or read.

An exception is the Channel Enable bit in the Peripheral Channel Control registers (PCHCTRLm.CHEN). When changing this bit, the bit value must be read-back to ensure the synchronization is complete and to assert glitch free internal operation. Note that changing the bit value under ongoing synchronization will *not* generate an error.

The following registers are synchronized when written:

- Generic Clock Generator Control register (GENCTRLn)
- Control A register (CTRLA)

Required write-synchronization is denoted by the "Write-Synchronized" property in the register description.

#### Related Links

[CTRLA](#)

[Register Synchronization](#)

[PCHCTRLm](#)



## 17.7 Register Summary

Offset	Name	Bit Pos.									
0x00	CTRLA	7:0								SWRST	
0x01 ... 0x03	Reserved										
0x04	SYNCBUSY	7:0	GENCTRLx	GENCTRLx	GENCTRLx	GENCTRLx	GENCTRLx	GENCTRLx		SWRST	
0x05		15:8						GENCTRLx	GENCTRLx	GENCTRLx	
0x06		23:16									
0x07		31:24									
0x08 ... 0x1F	Reserved										
0x20	GENCTRLn0	7:0				SRC[4:0]					
0x21		15:8			RUNSTDBY	DIVSEL	OE	OOV	IDC	GENEN	
0x22		23:16	DIV[7:0]								
0x23		31:24	DIV[15:8]								
0x24	GENCTRLn1	7:0				SRC[4:0]					
0x25		15:8			RUNSTDBY	DIVSEL	OE	OOV	IDC	GENEN	
0x26		23:16	DIV[7:0]								
0x27		31:24	DIV[15:8]								
0x28	GENCTRLn2	7:0				SRC[4:0]					
0x29		15:8			RUNSTDBY	DIVSEL	OE	OOV	IDC	GENEN	
0x2A		23:16	DIV[7:0]								
0x2B		31:24	DIV[15:8]								
0x2C	GENCTRLn3	7:0				SRC[4:0]					
0x2D		15:8			RUNSTDBY	DIVSEL	OE	OOV	IDC	GENEN	
0x2E		23:16	DIV[7:0]								
0x2F		31:24	DIV[15:8]								
0x30	GENCTRLn4	7:0				SRC[4:0]					
0x31		15:8			RUNSTDBY	DIVSEL	OE	OOV	IDC	GENEN	
0x32		23:16	DIV[7:0]								
0x33		31:24	DIV[15:8]								
0x34	GENCTRLn5	7:0				SRC[4:0]					
0x35		15:8			RUNSTDBY	DIVSEL	OE	OOV	IDC	GENEN	
0x36		23:16	DIV[7:0]								
0x37		31:24	DIV[15:8]								
0x38	GENCTRLn6	7:0				SRC[4:0]					
0x39		15:8			RUNSTDBY	DIVSEL	OE	OOV	IDC	GENEN	
0x3A		23:16	DIV[7:0]								
0x3B		31:24	DIV[15:8]								
0x3C	GENCTRLn7	7:0				SRC[4:0]					
0x3D		15:8			RUNSTDBY	DIVSEL	OE	OOV	IDC	GENEN	
0x3E		23:16	DIV[7:0]								
0x3F		31:24	DIV[15:8]								
0x40	GENCTRLn8	7:0				SRC[4:0]					

Offset	Name	Bit Pos.								
0x41		15:8			RUNSTDBY	DIVSEL	OE	OOV	IDC	GENEN
0x42		23:16	DIV[7:0]							
0x43		31:24	DIV[15:8]							
0x44 ... 0x7F	Reserved									
0x80	PCHCTRLm	7:0	WRTLOCK	CHEN				GEN[3:0]		
0x81		15:8								
0x82		23:16								
0x83		31:24								

## 17.8 Register Description

Registers can be 8, 16, or 32 bits wide. Atomic 8-, 16- and 32-bit accesses are supported. In addition, the 8-bit quarters and 16-bit halves of a 32-bit register, and the 8-bit halves of a 16-bit register can be accessed directly.

Some registers are optionally write-protected by the Peripheral Access Controller (PAC). Optional PAC write-protection is denoted by the "PAC Write-Protection" property in each individual register description. For details, refer to [Register Access Protection](#).

Some registers are synchronized when read and/or written. Synchronization is denoted by the "Write-Synchronized" or the "Read-Synchronized" property in each individual register description. For details, refer to [Synchronization](#).

### 17.8.1 Control A

**Name:** CTRLA

**Offset:** 0x00 [ID-000008c2]

**Reset:** 0x00

**Property:** PAC Write-Protection, Write-Synchronized

Bit	7	6	5	4	3	2	1	0
								SWRST
Access								R/W
Reset								0

#### Bit 0 – SWRST: Software Reset

Writing a zero to this bit has no effect.

Setting this bit to 1 will reset all registers in the GCLK to their initial state after a Power Reset, except for generic clocks and associated Generators that have their WRTLOCK bit in PCHCTRLm set to 1.

Refer to GENCTRL Reset Value for details on GENCTRL register reset.

Refer to PCHCTRL Reset Value for details on PCHCTRL register reset.

Due to synchronization, there is a waiting period between setting CTRLA.SWRST and a completed Reset. CTRLA.SWRST and SYNCBUSY.SWRST will both be cleared when the reset is complete.

Value	Description
0	There is no Reset operation ongoing.
1	A Reset operation is ongoing.

## 17.8.2 Synchronization Busy

**Name:** SYNCBUSY  
**Offset:** 0x04 [ID-000008c2]  
**Reset:** 0x00000000  
**Property:** –

Bit	31	30	29	28	27	26	25	24
Access								
Reset								
Bit	23	22	21	20	19	18	17	16
Access								
Reset								
Bit	15	14	13	12	11	10	9	8
						GENCTRLx	GENCTRLx	GENCTRLx
Access						R	R	R
Reset						0	0	0
Bit	7	6	5	4	3	2	1	0
	GENCTRLx	GENCTRLx	GENCTRLx	GENCTRLx	GENCTRLx	GENCTRLx		SWRST
Access	R	R	R	R	R	R		R
Reset	0	0	0	0	0	0		0

### Bits 2,3,4,5,6,7,8,9,10 – GENCTRLx: Generator Control x Synchronization Busy

This bit is cleared when the synchronization of the Generator Control n register (GENCTRLn) between clock domains is complete, or when clock switching operation is complete.

This bit is set when the synchronization of the Generator Control n register (GENCTRLn) between clock domains is started.

### Bit 0 – SWRST: Software Reset Synchronization Busy

This bit is cleared when the synchronization of the CTRLA.SWRST register bit between clock domains is complete.

This bit is set when the synchronization of the CTRLA.SWRST register bit between clock domains is started.

## 17.8.3 Generator Control

GENCTRLn controls the settings of Generic Generator n (n=0..8).

**Name:** GENCTRLn  
**Offset:** 0x20 + n\*0x04 [n=0..8]  
**Reset:** 0x00000106 for Generator n=0, else 0x00000000  
**Property:** PAC Write-Protection, Write-Synchronized

	Bit	31	30	29	28	27	26	25	24
		DIV[15:8]							
Access		R/W	R/W	R/W	R/W	R/W	R/W	R/W	R/W
Reset		0	0	0	0	0	0	0	0
	Bit	23	22	21	20	19	18	17	16
		DIV[7:0]							
Access		R/W	R/W	R/W	R/W	R/W	R/W	R/W	R/W
Reset		0	0	0	0	0	0	0	0
	Bit	15	14	13	12	11	10	9	8
				RUNSTDBY	DIVSEL	OE	OOV	IDC	GENEN
Access									
Reset									
	Bit	7	6	5	4	3	2	1	0
					SRC[4:0]				
Access					R/W	R/W	R/W	R/W	R/W
Reset					0	0	0	0	0

### Bits 31:16 – DIV[15:0]: Division Factor

These bits represent a division value for the corresponding Generator. The actual division factor is dependent on the state of DIVSEL. The number of relevant DIV bits for each Generator can be seen in this table. Written bits outside of the specified range will be ignored.

**Table 17-3. Division Factor Bits**

Generic Clock Generator	Division Factor Bits
Generator 0	8 division factor bits - DIV[7:0]
Generator 1	16 division factor bits - DIV[15:0]
Generator 2	5 division factor bits - DIV[4:0]
Generator 3 - 8	8 division factor bits - DIV[7:0]

### Bit 13 – RUNSTDBY: Run in Standby

This bit is used to keep the Generator running in Standby as long as it is configured to output to a dedicated GCLK\_IO pin. If GENCTRLn.OE is zero, this bit has no effect and the generator will only be running if a peripheral requires the clock.

Value	Description
0	The Generator is stopped in Standby and the GCLK_IO pin state (one or zero) will be dependent on the setting in GENCTRL.OOV.
1	The Generator is kept running and output to its dedicated GCLK_IO pin during Standby mode.

## Bit 12 – DIVSEL: Divide Selection

This bit determines how the division factor of the clock source of the Generator will be calculated from DIV. If the clock source should not be divided, DIVSEL must be 0 and the GENCTRLn.DIV value must be either 0 or 1.

Value	Description
0	The Generator clock frequency equals the clock source frequency divided by GENCTRLn.DIV.
1	The Generator clock frequency equals the clock source frequency divided by $2^{(\text{GENCTRLn.DIV}+1)}$ .

## Bit 11 – OE: Output Enable

This bit is used to output the Generator clock output to the corresponding pin (GCLK\_IO), as long as GCLK\_IO is not defined as the Generator source in the GENCTRLn.SRC bit field.

Value	Description
0	No Generator clock signal on pin GCLK_IO.
1	The Generator clock signal is output on the corresponding GCLK_IO, unless GCLK_IO is selected as a generator source in the GENCTRLn.SRC bit field.

## Bit 10 – OOV: Output Off Value

This bit is used to control the clock output value on pin (GCLK\_IO) when the Generator is turned off or the OE bit is zero, as long as GCLK\_IO is not defined as the Generator source in the GENCTRLn.SRC bit field.

Value	Description
0	The GCLK_IO will be LOW when generator is turned off or when the OE bit is zero.
1	The GCLK_IO will be HIGH when generator is turned off or when the OE bit is zero.

## Bit 9 – IDC: Improve Duty Cycle

This bit is used to improve the duty cycle of the Generator output to 50/50 for odd division factors.

Value	Description
0	Generator output clock duty cycle is not balanced to 50/50 for odd division factors.
1	Generator output clock duty cycle is 50/50.

## Bit 8 – GENEN: Generator Enable

This bit is used to enable and disable the Generator.

Value	Description
0	Generator is disabled.
1	Generator is enabled.

## Bits 4:0 – SRC[4:0]: Generator Clock Source Selection

These bits select the Generator clock source, as shown in this table.

**Table 17-4. Generator Clock Source Selection**

Value	Name	Description
0x00	XOSC	XOSC oscillator output
0x01	GCLK_IN	Generator input pad (GCLK_IO)
0x02	GCLK_GEN1	Generic clock generator 1 output

Value	Name	Description
0x03	OSCULP32K	OSCULP32K oscillator output
0x04	OSC32K	OSC32K oscillator output
0x05	XOSC32K	XOSC32K oscillator output
0x06	OSC48M	OSC48M oscillator output
0x07	DPLL96M	DPLL96M output
0x08-0x1F	Reserved	Reserved for future use

A Power Reset will reset all GENCTRLn registers. the Reset values of the GENCTRLn registers are shown in table below.

**Table 17-5. GENCTRLn Reset Value after a Power Reset**

GCLK Generator	Reset Value after a Power Reset
0	0x00000106
others	0x00000000

A User Reset will reset the associated GENCTRL register unless the Generator is the source of a locked Peripheral Channel (PCHCTRLm.WRTLOCK=1). The reset values of the GENCTRL register are as shown in the table below.

**Table 17-6. GENCTRLn Reset Value after a User Reset**

GCLK Generator	Reset Value after a User Reset
0	0x00000106
others	No change if the generator is used by a Peripheral Channel m with PCHCTRLm.WRTLOCK=1 else 0x00000000

#### 17.8.4 Peripheral Channel Control

PCHCTRLm controls the settings of Peripheral Channel number m (m=0..40).

**Name:** PCHCTRLm  
**Offset:** 0x80 [ID-000008c2]  
**Reset:** 0x00000000  
**Property:** PAC Write-Protection



**Bit 7 – WRTLOCK: Write Lock**

After this bit is set to '1', further writes to the PCHCTRLm register will be discarded. The control register of the corresponding Generator n (GENCTRLn), as assigned in PCHCTRLm.GEN, will also be locked. It can only be unlocked by a Power Reset.

Note that Generator 0 cannot be locked.

Value	Description
0	The Peripheral Channel register and the associated Generator register are not locked
1	The Peripheral Channel register and the associated Generator register are locked

**Bit 6 – CHEN: Channel Enable**

This bit is used to enable and disable a Peripheral Channel.

Value	Description
0	The Peripheral Channel is disabled
1	The Peripheral Channel is enabled

**Bits 3:0 – GEN[3:0]: Generator Selection**

This bit field selects the Generator to be used as the source of a peripheral clock, as shown in the table below:

**Table 17-7. Generator Selection**

Value	Description
0x0	Generic Clock Generator 0
0x1	Generic Clock Generator 1
0x2	Generic Clock Generator 2
0x3	Generic Clock Generator 3
0x4	Generic Clock Generator 4

Value	Description
0x5	Generic Clock Generator 5
0x6	Generic Clock Generator 6
0x7	Generic Clock Generator 7
0x8	Generic Clock Generator 8
0x9 - 0xF	Reserved

**Table 17-8. Reset Value after a User Reset or a Power Reset**

Reset	PCHCTRLm.GEN	PCHCTRLm.CHEN	PCHCTRLm.WRTLOCK
Power Reset	0x0	0x0	0x0
User Reset	If WRTLOCK = 0 : 0x0  If WRTLOCK = 1: no change	If WRTLOCK = 0 : 0x0  If WRTLOCK = 1: no change	No change

A Power Reset will reset all the PCHCTRLm registers.

A User Reset will reset a PCHCTRL if WRTLOCK=0, or else, the content of that PCHCTRL remains unchanged.

PCHCTRL register Reset values are shown in the table PCHCTRLm Mapping.

**Table 17-9. PCHCTRLm Mapping**

index(m)	Name	Description
0	GCLK_DPLL	FDPLL96M input clock source for reference
1	GCLK_DPLL_32K	FDPLL96M 32kHz clock for FDPLL96M internal clock timer
2	GCLK_EIC	EIC
3	GCLK_FREQM_MSR	FREQM Measure
4	GCLK_FREQM_REF	FREQM Reference
5	-	Reserved
6	GCLK_EVSYS_CHANNEL_0	EVSYS_CHANNEL_0
7	GCLK_EVSYS_CHANNEL_1	EVSYS_CHANNEL_1
8	GCLK_EVSYS_CHANNEL_2	EVSYS_CHANNEL_2
9	GCLK_EVSYS_CHANNEL_3	EVSYS_CHANNEL_3
10	GCLK_EVSYS_CHANNEL_4	EVSYS_CHANNEL_4
11	GCLK_EVSYS_CHANNEL_5	EVSYS_CHANNEL_5
12 - 17	-	Reserved
18	GCLK_SERCOM[0,1,2,3]_SLOW	SERCOM[0,1,2,3]_SLOW
19	GCLK_SERCOM0_CORE	SERCOM0_CORE



index(m)	Name	Description
20	GCLK_SERCOM1_CORE	SERCOM1_CORE
21	GCLK_SERCOM2_CORE	SERCOM2_CORE
22	GCLK_SERCOM3_CORE	SERCOM3_CORE
23		
24	GCLK_SERCOM5_SLOW	
25	GCLK_SERCOM5_CORE	SERCOM5_CORE
26	-	Reserved
27	-	Reserved
28	GCLK_TCC0, GCLK_TCC1	TCC0,TCC1
29	GCLK_TCC2	TCC2
30	GCLK_TC0, GCLK_TC1	TC0,TC1
31	GCLK_TC2, GCLK_TC3	TC2,TC3
32	GCLK_TC4	TC4
33	GCLK_ADC0	ADC0
34	-	Reserved
35	-	Reserved
36	-	Reserved
37	GCLK_PTC	PTC
38	GCLK_CCL	CCL
39	-	Reserved
40	GCLK_AC	AC
41	GCLK_SERCOM6_CORE	SERCOM6_CORE
42	GCLK_SERCOM7_CORE	SERCOM7_CORE
43	GCLK_TC5	TC5
44	GCLK_TC6	TC6
45	GCLK_TC7	TC7

## 18. MCLK – Main Clock

### 18.1 Overview

The Main Clock (MCLK) controls the synchronous clock generation of the device.

Using a clock provided by the Generic Clock Module (GCLK\_MAIN), the Main Clock Controller provides synchronous system clocks to the CPU and the modules connected to the AHBx and the APBx bus. The synchronous system clocks are divided into a number of clock domains. Each clock domain can run at different frequencies, enabling the user to save power by running peripherals at a relatively low clock frequency, while maintaining high CPU performance or vice versa. In addition, the clock can be masked for individual modules, enabling the user to minimize power consumption.

### 18.2 Features

- Generates CPU, AHB, and APB system clocks
  - Clock source and division factor from GCLK
  - Clock prescaler with 1x to 128x division
- Safe run-time clock switching from GCLK
- Module-level clock gating through maskable peripheral clocks

### 18.3 Block Diagram

Figure 18-1. MCLK Block Diagram



### 18.4 Signal Description

Not applicable.

### 18.5 Product Dependencies

In order to use this peripheral, other parts of the system must be configured correctly, as described below.

#### 18.5.1 I/O Lines

Not applicable.

## 18.5.2 Power Management

The MCLK will operate in all sleep modes if a synchronous clock is required in these modes.

### Related Links

[PM – Power Manager](#)

## 18.5.3 Clocks

The MCLK bus clock (CLK\_MCLK\_APB) can be enabled and disabled in the Main Clock module, and the default state of CLK\_MCLK\_APB can be found in the Peripheral Clock Masking section. If this clock is disabled, it can only be re-enabled by a reset.

The Generic Clock GCLK\_MAIN is required to generate the Main Clocks. GCLK\_MAIN is configured in the Generic Clock Controller, and can be re-configured by the user if needed.

### Related Links

[GCLK - Generic Clock Controller](#)

[Peripheral Clock Masking](#)

### 18.5.3.1 Main Clock

The main clock GCLK\_MAIN is the common source for the synchronous clocks. This is fed into the common 8-bit prescaler that is used to generate synchronous clocks to the CPU, AHBx, and APBx modules.

### 18.5.3.2 CPU Clock

The CPU clock (CLK\_CPU) is routed to the CPU. Halting the CPU clock inhibits the CPU from executing instructions.

### 18.5.3.3 APBx and AHBx Clock

The APBx clocks (CLK\_APBx) and the AHBx clocks (CLK\_AHBx) are the root clock source used by modules requiring a clock on the APBx and the AHBx bus. These clocks are always synchronous to the CPU clock, and can run even when the CPU clock is turned off in sleep mode. A clock gater is inserted after the common APB clock to gate any APBx clock of a module on APBx bus, as well as the AHBx clock.

### 18.5.3.4 Clock Domains

The device has these synchronous clock domains:

- CPU synchronous clock domain (CPU Clock Domain). Frequency is  $f_{CPU}$ .

See also the related links for the clock domain partitioning.

### Related Links

[Peripheral Clock Masking](#)

## 18.5.4 DMA

Not applicable.

## 18.5.5 Interrupts

The interrupt request line is connected to the Interrupt Controller. Using the MCLK interrupt requires the Interrupt Controller to be configured first.

## 18.5.6 Events

Not applicable.

## 18.5.7 Debug Operation

When the CPU is halted in debug mode, the MCLK continues normal operation. In sleep mode, the clocks generated from the MCLK are kept running to allow the debugger accessing any module. As a consequence, power measurements are incorrect in debug mode.

## 18.5.8 Register Access Protection

All registers with write-access can be write-protected optionally by the Peripheral Access Controller (PAC), except for the following registers:

- Interrupt Flag register (INTFLAG)

Optional write-protection by the Peripheral Access Controller (PAC) is denoted by the "PAC Write-Protection" property in each individual register description.

PAC write-protection does not apply to accesses through an external debugger.

### Related Links

[PAC - Peripheral Access Controller](#)

## 18.5.9 Analog Connections

Not applicable.

## 18.6 Functional Description

### 18.6.1 Principle of Operation

The GCLK\_MAIN clock signal from the GCLK module is the source for the main clock, which in turn is the common root for the synchronous clocks for the CPU, APBx, and AHBx modules. The GCLK\_MAIN is divided by an 8-bit prescaler. Each of the derived clocks can run from any divided or undivided main clock, ensuring synchronous clock sources for each clock domain. The clock domain (CPU) can be changed on the fly to respond to variable load in the application. The clocks for each module in a clock domain can be masked individually to avoid power consumption in inactive modules. Depending on the sleep mode, some clock domains can be turned off.

### 18.6.2 Basic Operation

#### 18.6.2.1 Initialization

After a Reset, the default clock source of the GCLK\_MAIN clock is started and calibrated before the CPU starts running. The GCLK\_MAIN clock is selected as the main clock without any prescaler division.

By default, only the necessary clocks are enabled.

### Related Links

[Peripheral Clock Masking](#)

#### 18.6.2.2 Enabling, Disabling, and Resetting

The MCLK module is always enabled and cannot be reset.

#### 18.6.2.3 Selecting the Main Clock Source

Refer to the Generic Clock Controller description for details on how to configure the clock source of the GCLK\_MAIN clock.

### Related Links

[GCLK - Generic Clock Controller](#)

## 18.6.2.4 Selecting the Synchronous Clock Division Ratio

The main clock GCLK\_MAIN feeds an 8-bit prescaler, which can be used to generate the synchronous clocks. By default, the synchronous clocks run on the undivided main clock. The user can select a prescaler division for the CPU clock domain by writing the Division (DIV) bits in the CPU Clock Division register CPUDIV, resulting in a CPU clock domain frequency determined by this equation:

$$f_{CPU} = \frac{f_{main}}{CPUDIV}$$

If the application attempts to write forbidden values in CPUDIV register, registers are written but these bad values are not used and a violation is reported to the PAC module.

Division bits (DIV) can be written without halting or disabling peripheral modules. Writing DIV bits allows a new clock setting to be written to all synchronous clocks belonging to the corresponding clock domain at the same time.

**Figure 18-2. Synchronous Clock Selection and Prescaler**



## 18.6.2.5 Clock Ready Flag

There is a slight delay between writing to CPUDIV until the new clock settings become effective.

During this interval, the Clock Ready flag in the Interrupt Flag Status and Clear register (`INTFLAG.CKRDY`) will return zero when read. If `CKRDY` in the `INTENSET` register is set to '1', the Clock Ready interrupt will be triggered when the new clock setting is effective. The clock settings (`CLKCFG`) must not be re-written while `INTFLAG.CKRDY` reads '0'. The system may become unstable or hang, and a violation is reported to the PAC module.

### Related Links

[PAC - Peripheral Access Controller](#)

## 18.6.2.6 Peripheral Clock Masking

It is possible to disable/enable the AHB or APB clock for a peripheral by writing the corresponding bit in the Clock Mask registers (`APBxMASK`) to '0'/'1'. The default state of the peripheral clocks is shown here.

**Table 18-1. Peripheral Clock Default State**

CPU Clock Domain	
Peripheral Clock	Default State
CLK_AC_APB	Disabled
CLK_ADC0_APB	Disabled

CPU Clock Domain	
Peripheral Clock	Default State
CLK_BRIDGE_A_AHB	Enabled
CLK_BRIDGE_B_AHB	Enabled
CLK_BRIDGE_C_AHB	Enabled
CLK_BRIDGE_D_AHB	Enabled
CLK_CCL_APB	Disabled
CLK_DIVAS_AHB	Enabled
CLK_DMAC_AHB	Enabled
CLK_DMAC_APB	Enabled
CLK_DSU_AHB	Enabled
CLK_DSU_APB	Enabled
CLK_EIC_APB	Enabled
CLK_EVSYSP_APB	Disabled
CLK_FREQM_APB	Enabled
CLK_GCLK_AHB	Enabled
CLK_HAMATRIX_APB	Disabled
CLK_MCLK_APB	Enabled
CLK_MTB_APB	Enabled
CLK_NVMCTRL_AHB	Enabled
CLK_NVMCTRL_APB	Enabled
CLK_OSCCTRL_APB	Enabled
CLK_OSC32CTRL_APB	Enabled
CLK_PAC_AHB	Enabled
CLK_PAC_APB	Enabled
CLK_PORT_APB	Enabled
CLK_PTC_APB	Disabled
CLK_SERCOM0_APB	Disabled
CLK_SERCOM1_AHB	Disabled
CLK_SERCOM2_APB	Disabled
CLK_SERCOM3_APB	Disabled
CLK_SERCOM4_APB	Disabled
CLK_SERCOM5_APB	Disabled

CPU Clock Domain	
Peripheral Clock	Default State
CLK_SERCOM6_APB	Disabled
CLK_SERCOM7_APB	Disabled
CLK_TCC0_APB	Disabled
CLK_TCC1_APB	Disabled
CLK_TCC2_APB	Disabled
CLK_TC0_APB	Disabled
CLK_TC1_APB	Disabled
CLK_TC2_APB	Disabled
CLK_TC3_APB	Disabled
CLK_TC4_APB	Disabled
CLK_TC5_APB	Disabled
CLK_TC6_APB	Disabled
CLK_TC7_APB	Disabled
CLK_WDT_APB	Enabled

Backup Clock Domain	
Peripheral Clock	Default State
CLK_OSC32KCTRL_APB	Enabled
CLK_PM_APB	Enabled
CLK_SUPC_APB	Enabled
CLK_RSTC_APB	Enabled
CLK_RTC_APB	Enabled

When the APB clock is not provided to a module, its registers cannot be read or written. The module can be re-enabled later by writing the corresponding mask bit to '1'.

A module may be connected to several clock domains (for instance, AHB and APB), in which case it will have several mask bits.

Note that clocks should only be switched off if it is certain that the module will not be used: Switching off the clock for the NVM Controller (NVMCTRL) will cause a problem if the CPU needs to read from the Flash Memory. Switching off the clock to the MCLK module (which contains the mask registers) or the corresponding APBx bridge, will make it impossible to write the mask registers again. In this case, they can only be re-enabled by a system reset.

### 18.6.3 DMA Operation

Not applicable.

## 18.6.4 Interrupts

The peripheral has the following interrupt sources:

- Clock Ready (CKRDY): indicates that CPU clocks are ready. This interrupt is a synchronous wake-up source.

Each interrupt source has an interrupt flag associated with it. The interrupt flag in the Interrupt Flag Status and Clear (**INTFLAG**) register is set when the interrupt condition occurs. Each interrupt can be enabled individually by writing a '1' to the corresponding enabling bit in the Interrupt Enable Set (**INTENSET**) register, and disabled by writing a '1' to the corresponding clearing bit in the Interrupt Enable Clear (**INTENCLR**) register.

An interrupt request is generated when the interrupt flag is set and the corresponding interrupt is enabled. The interrupt request remains active until the interrupt flag is cleared, the interrupt is disabled or the peripheral is reset. An interrupt flag is cleared by writing a '1' to the corresponding bit in the **INTFLAG** register. Each peripheral can have one interrupt request line per interrupt source or one common interrupt request line for all the interrupt sources. If the peripheral has one common interrupt request line for all the interrupt sources, the user must read the **INTFLAG** register to determine which interrupt condition is present.

### Related Links

[Overview](#)

[Sleep Mode Controller](#)

[PM – Power Manager](#)

## 18.6.5 Events

Not applicable.

## 18.6.6 Sleep Mode Operation

In IDLE sleep mode, the MCLK is still running on the selected main clock.

In STANDBY sleep mode, the MCLK is frozen if no synchronous clock is required.



## 18.7 Register Summary - MCLK

Offset	Name	Bit Pos.									
0x00	CTRLA	7:0									
0x01	INTENCLR	7:0								CKRDY	
0x02	INTENSET	7:0								CKRDY	
0x03	INTFLAG	7:0								CKRDY	
0x04	Reserved										
0x05	CPUDIV	7:0	CPUDIV[7:0]								
0x06 ... 0x0F	Reserved										
0x10	AHBMASK	7:0	DMAC	HSRAM	NVMCTRL	HMATRIXHS	DSU	APBC	APBB	APBA	
0x11		15:8					PAC				
0x12		23:16									
0x13		31:24									
0x14	APBAMASK	7:0	GCLK	SUPC	OSC32KCTRL	OSCCTRL	RSTC	MCLK	PM	PAC	
0x15		15:8					FREQM	EIC	RTC	WDT	
0x16		23:16									
0x17		31:24									
0x18	APBBMASK	7:0			HMATRIXHS			NVMCTRL	DSU	PORT	
0x19		15:8									
0x1A		23:16									
0x1B		31:24									
0x1C	APBCMASK	7:0		SERCOM5	SERCOM4	SERCOM3	SERCOM2	SERCOM1	SERCOM0	EVSYS	
0x1D		15:8	TC3	TC2	TC1	TC0	TCC2	TCC1	TCC0		
0x1E		23:16	CCL	PTC		AC			ADC0	TC4	
0x1F		31:24									
0x20	APBDMASK	7:0				TC7	TC6	TC5	SERCOM7	SERCOM6	
0x21		15:8									
0x22		23:16									
0x23		31:24									

## 18.8 Register Description

Registers can be 8, 16, or 32 bits wide. Atomic 8-, 16-, and 32-bit accesses are supported. In addition, the 8-bit quarters and 16-bit halves of a 32-bit register, and the 8-bit halves of a 16-bit register can be accessed directly.

Some registers can be write-protected optionally by the Peripheral Access Controller (PAC). This is denoted by the property "PAC Write-Protection" in each individual register description. Refer to the [Register Access Protection](#) for details.

### 18.8.1 Control A

All bits in this register are reserved.

**Name:** CTRLA  
**Offset:** 0x00 [ID-00001086]  
**Reset:** 0x00  
**Property:** PAC Write-Protection



### 18.8.2 Interrupt Enable Clear

This register allows the user to disable an interrupt without doing a read-modify-write operation. Changes in this register will also be reflected in the Interrupt Enable Set (INTENSET) register.

**Name:** INTENCLR  
**Offset:** 0x01 [ID-00001086]  
**Reset:** 0x00  
**Property:** PAC Write-Protection



#### Bit 0 – CKRDY: Clock Ready Interrupt Enable

Writing a '0' to this bit has no effect.

Writing a '1' to this bit will clear the Clock Ready Interrupt Enable bit and the corresponding interrupt request.

Value	Description
0	The Clock Ready interrupt is enabled and will generate an interrupt request when the Clock Ready Interrupt Flag is set.
1	The Clock Ready interrupt is disabled.

### 18.8.3 Interrupt Enable Set

This register allows the user to enable an interrupt without doing a read-modify-write operation. Changes in this register will also be reflected in the Interrupt Enable Clear (INTENCLR) register.

**Name:** INTENSET  
**Offset:** 0x02 [ID-00001086]  
**Reset:** 0x00  
**Property:** PAC Write-Protection

Bit	7	6	5	4	3	2	1	0
								CKRDY
Access								R/W
Reset								0

**Bit 0 – CKRDY: Clock Ready Interrupt Enable**

Writing a '0' to this bit has no effect.

Writing a '1' to this bit will set the Clock Ready Interrupt Enable bit and enable the Clock Ready interrupt.

Value	Description
0	The Clock Ready interrupt is disabled.
1	The Clock Ready interrupt is enabled.

### 18.8.4 Interrupt Flag Status and Clear

**Name:** INTFLAG

**Offset:** 0x03 [ID-00001086]

**Reset:** 0x01

**Property:** –

Bit	7	6	5	4	3	2	1	0
								CKRDY
Access								R/W
Reset								1

**Bit 0 – CKRDY: Clock Ready**

This flag is cleared by writing a '1' to the flag.

This flag is set when the synchronous CPU, APBx, and AHBx clocks have frequencies as indicated in the CLKCFG registers and will generate an interrupt if [INTENCLR/SET.CKRDY](#) is '1'.

Writing a '0' to this bit has no effect.

Writing a '1' to this bit clears the Clock Ready interrupt flag.

### 18.8.5 CPU Clock Division

**Name:** CPUDIV

**Offset:** 0x05 [ID-00001086]

**Reset:** 0x01

**Property:** PAC Write-Protection

Bit	7	6	5	4	3	2	1	0
	CPUDIV[7:0]							
Access	R/W	R/W	R/W	R/W	R/W	R/W	R/W	R/W
Reset	0	0	0	0	0	0	0	1

**Bits 7:0 – CPUDIV[7:0]: CPU Clock Division Factor**

These bits define the division ratio of the main clock prescaler related to the CPU clock domain.

Frequencies must never exceed the specified maximum frequency for each clock domain.

Value	Name	Description
0x01	DIV1	Divide by 1
0x02	DIV2	Divide by 2
0x04	DIV4	Divide by 4
0x08	DIV8	Divide by 8
0x10	DIV16	Divide by 16
0x20	DIV32	Divide by 32
0x40	DIV64	Divide by 64
0x80	DIV128	Divide by 128
others	-	Reserved

## 18.8.6 AHB Mask

**Name:** AHBMASK  
**Offset:** 0x10 [ID-00001086]  
**Reset:** 0x000003CFF  
**Property:** PAC Write-Protection

Bit	31	30	29	28	27	26	25	24
Access			R	R	R	R	R	R
Reset			0	0	0	0	0	0
Bit	23	22	21	20	19	18	17	16
Access	R	R	R	R	R	R	R	R
Reset	0	0	0	0	0	0	0	0
Bit	15	14	13	12	11	10	9	8
						PAC		
Access	R	R	R	R	R	R/W		
Reset	0	0	0	0	1	1		
Bit	7	6	5	4	3	2	1	0
	DMAC	HSRAM	NVMCTRL	HMATRIXHS	DSU	APBC	APBB	APBA
Access	R/W	R/W	R/W	R/W	R/W	R/W	R/W	R/W
Reset	1	1	1	1	1	1	1	1

### Bit 13 – APBD: APBD AHB Clock Enable

Value	Description
0	The AHB clock for the APBD is stopped.
1	The AHB clock for the APBD is enabled.

### Bit 12 – DIVAS: DIVAS AHB Clock Enable

Value	Description
0	The AHB clock for the DIVAS is stopped.
1	The AHB clock for the DIVAS is enabled.

## Bit 10 – PAC: PAC AHB Clock Enable

Value	Description
0	The AHB clock for the PAC is stopped.
1	The AHB clock for the PAC is enabled.

## Bit 7 – DMAC: DMAC AHB Clock Enable

Value	Description
0	The AHB clock for the DMAC is stopped.
1	The AHB clock for the DMAC is enabled.

## Bit 6 – HSRAM: HSRAM AHB Clock Enable

Value	Description
0	The AHB clock for the HSRAM is stopped.
1	The AHB clock for the HSRAM is enabled.

## Bit 5 – NVMCTRL: NVMCTRL AHB Clock Enable

Value	Description
0	The AHB clock for the NVMCTRL is stopped.
1	The AHB clock for the NVMCTRL is enabled.

## Bit 4 – HMATRIXHS: HMATRIXHS AHB Clock Enable

Value	Description
0	The AHB clock for the HMATRIXHS is stopped.
1	The AHB clock for the HMATRIXHS is enabled.

## Bit 3 – DSU: DSU AHB Clock Enable

Value	Description
0	The AHB clock for the DSU is stopped.
1	The AHB clock for the DSU is enabled.

## Bit 2 – APBC: APBC AHB Clock Enable

Value	Description
0	The AHB clock for the APBC is stopped.
1	The AHB clock for the APBC is enabled.

## Bit 1 – APBB: APBB AHB Clock Enable

Value	Description
0	The AHB clock for the APBB is stopped.
1	The AHB clock for the APBB is enabled.

## Bit 0 – APBA: APBA AHB Clock Enable

Value	Description
0	The AHB clock for the APBA is stopped.
1	The AHB clock for the APBA is enabled.

## 18.8.7 APBA Mask

**Name:** APBAMASK  
**Offset:** 0x14 [ID-00001086]  
**Reset:** 0x00000FFF  
**Property:** PAC Write-Protection

Bit	31	30	29	28	27	26	25	24
Access								
Reset								
Bit	23	22	21	20	19	18	17	16
Access								
Reset								
Bit	15	14	13	12	11	10	9	8
					FREQM	EIC	RTC	WDT
Access					R/W	R/W	R/W	R/W
Reset					1	1	1	1
Bit	7	6	5	4	3	2	1	0
	GCLK	SUPC	OSC32KCTRL	OSCCTRL	RSTC	MCLK	PM	PAC
Access	R/W	R/W	R/W	R/W	R/W	R/W	R/W	R/W
Reset	1	1	1	1	1	1	1	1

### Bit 11 – FREQM: FREQM APBA Clock Enable

Value	Description
0	The APBA clock for the FREQM is stopped.
1	The APBA clock for the FREQM is enabled.

### Bit 10 – EIC: EIC APBA Clock Enable

Value	Description
0	The APBA clock for the EIC is stopped.
1	The APBA clock for the EIC is enabled.

### Bit 9 – RTC: RTC APBA Clock Enable

Value	Description
0	The APBA clock for the RTC is stopped.
1	The APBA clock for the RTC is enabled.

### Bit 8 – WDT: WDT APBA Clock Enable

Value	Description
0	The APBA clock for the WDT is stopped.
1	The APBA clock for the WDT is enabled.

## Bit 7 – GCLK: GCLK APBA Clock Enable

Value	Description
0	The APBA clock for the GCLK is stopped.
1	The APBA clock for the GCLK is enabled.

## Bit 6 – SUPC: SUPC APBA Clock Enable

Value	Description
0	The APBA clock for the SUPC is stopped.
1	The APBA clock for the SUPC is enabled.

## Bit 5 – OSC32KCTRL: OSC32KCTRL APBA Clock Enable

Value	Description
0	The APBA clock for the OSC32KCTRL is stopped.
1	The APBA clock for the OSC32KCTRL is enabled.

## Bit 4 – OSCCTRL: OSCCTRL APBA Clock Enable

Value	Description
0	The APBA clock for the OSCCTRL is stopped.
1	The APBA clock for the OSCCTRL is enabled.

## Bit 3 – RSTC: RSTC APBA Clock Enable

Value	Description
0	The APBA clock for the RSTC is stopped.
1	The APBA clock for the RSTC is enabled.

## Bit 2 – MCLK: MCLK APBA Clock Enable

Value	Description
0	The APBA clock for the MCLK is stopped.
1	The APBA clock for the MCLK is enabled.

## Bit 1 – PM: PM APBA Clock Enable

Value	Description
0	The APBA clock for the PM is stopped.
1	The APBA clock for the PM is enabled.

## Bit 0 – PAC: PAC APBA Clock Enable

Value	Description
0	The APBA clock for the PAC is stopped.
1	The APBA clock for the PAC is enabled.

### 18.8.8 APBB Mask

**Name:** APBBMASK  
**Offset:** 0x18 [ID-00001086]  
**Reset:** 0x00000007  
**Property:** PAC Write-Protection



### Bit 5 – HMATRIXHS: HMATRIXHS APBB Clock Enable

Value	Description
0	The APBB clock for the HMATRIXHS is stopped
1	The APBB clock for the HMATRIXHS is enabled

### Bit 2 – NVMCTRL: NVMCTRL APBB Clock Enable

Value	Description
0	The APBB clock for the NVMCTRL is stopped
1	The APBB clock for the NVMCTRL is enabled

### Bit 1 – DSU: DSU APBB Clock Enable

Value	Description
0	The APBB clock for the DSU is stopped
1	The APBB clock for the DSU is enabled

### Bit 0 – PORT: PORT APBB Clock Enable

Value	Description
0	The APBB clock for the PORT is stopped.
1	The APBB clock for the PORT is enabled.

## 18.8.9 APBC Mask



**Name:** APBCMASK  
**Offset:** 0x1C  
**Reset:** 0x00000000  
**Property:** PAC Write-Protection

Bit	31	30	29	28	27	26	25	24
Access								
Reset								
Bit	23	22	21	20	19	18	17	16
Access	R/W	R/W		R/W			R/W	R/W
Reset	0	0		0			0	0
Bit	15	14	13	12	11	10	9	8
Access	R/W	R/W	R/W	R/W	R/W	R/W	R/W	
Reset	0	0	0	0	0	0	0	
Bit	7	6	5	4	3	2	1	0
Access		R/W	R/W	R/W	R/W	R/W	R/W	R/W
Reset		0	0	0	0	0	0	0

**Bit 23 – CCL: CCL APBC Clock Enable**

Value	Description
0	The APBC clock for the CCL is stopped.
1	The APBC clock for the CCL is enabled.

**Bit 22 – PTC: PTC APBC Mask Clock Enable**

Value	Description
0	The APBC clock for the PTC is stopped.
1	The APBC clock for the PTC is enabled.

**Bit 20 – AC: AC APBC Clock Enable**

Value	Description
0	The APBC clock for the AC is stopped.
1	The APBC clock for the AC is enabled.

**Bit 17 – ADC0: ADC0 APBC Clock Enable**

Value	Description
0	The APBC clock for the ADC0 is stopped.
1	The APBC clock for the ADC0 is enabled.

**Bit 16 – TC4: TC4 APBC Mask Clock Enable**

## Bit 15 – TC3: TC3 APBC Mask Clock Enable

Value	Description
0	The APBC clock for the TC3 is stopped.
1	The APBC clock for the TC3 is enabled.

## Bit 14 – TC2: TC2 APBC Mask Clock Enable

Value	Description
0	The APBC clock for the TC2 is stopped.
1	The APBC clock for the TC2 is enabled.

## Bit 13 – TC1: TC1 APBC Mask Clock Enable

Value	Description
0	The APBC clock for the TC1 is stopped.
1	The APBC clock for the TC1 is enabled.

## Bit 12 – TC0: TC0 APBC Mask Clock Enable

Value	Description
0	The APBC clock for the TC0 is stopped.
1	The APBC clock for the TC0 is enabled.

## Bit 11 – TCC2: TCC2 APBC Mask Clock Enable

Value	Description
0	The APBC clock for the TCC2 is stopped.
1	The APBC clock for the TCC2 is enabled.

## Bit 10 – TCC1: TCC1 APBC Mask Clock Enable

Value	Description
0	The APBC clock for the TCC1 is stopped.
1	The APBC clock for the TCC1 is enabled.

## Bit 9 – TCC0: TCC0 APBC Mask Clock Enable

Value	Description
0	The APBC clock for the TCC0 is stopped.
1	The APBC clock for the TCC0 is enabled.

## Bit 6 – SERCOM5: SERCOM5 APBC Mask Clock Enable

Value	Description
0	The APBC clock for the SERCOM5 is stopped.
1	The APBC clock for the SERCOM5 is enabled.

## Bit 5 – SERCOM4: SERCOM4 APBC Mask Clock Enable

Value	Description
0	The APBC clock for the SERCOM4 is stopped.
1	The APBC clock for the SERCOM4 is enabled.

## Bit 4 – SERCOM3: SERCOM3 APBC Mask Clock Enable

Value	Description
0	The APBC clock for the SERCOM3 is stopped.
1	The APBC clock for the SERCOM3 is enabled.

## Bit 3 – SERCOM2: SERCOM2 APBC Mask Clock Enable

Value	Description
0	The APBC clock for the SERCOM2 is stopped.
1	The APBC clock for the SERCOM2 is enabled.

## Bit 2 – SERCOM1: SERCOM1 APBC Mask Clock Enable

Value	Description
0	The APBC clock for the SERCOM1 is stopped.
1	The APBC clock for the SERCOM1 is enabled.

## Bit 1 – SERCOM0: SERCOM0 APBC Mask Clock Enable

Value	Description
0	The APBC clock for the SERCOM0 is stopped.
1	The APBC clock for the SERCOM0 is enabled.

## Bit 0 – EVSYS: EVSYS APBC Clock Enable

Value	Description
0	The APBC clock for the EVSYS is stopped.
1	The APBC clock for the EVSYS is enabled.

### 18.8.10 APBD Mask

**Name:** APBDMASK  
**Offset:** 0x20  
**Reset:** 0x00000000  
**Property:** PAC Write-Protection

Bit	31	30	29	28	27	26	25	24
Access								
Reset								
Bit	23	22	21	20	19	18	17	16
Access								
Reset								
Bit	15	14	13	12	11	10	9	8
Access								
Reset								
Bit	7	6	5	4	3	2	1	0
				TC7	TC6	TC5	SERCOM7	SERCOM6
Access				R/W	R/W	R/W	R/W	R/W
Reset				0	0	0	0	0

**Bit 4 – TC7: TC7 APBD Mask Clock Enable**

Value	Description
0	The APBD clock for the TC7 is stopped.
1	The APBD clock for the TC7 is enabled.

**Bit 3 – TC6: TC6 APBD Mask Clock Enable**

Value	Description
0	The APBD clock for the TC6 is stopped.
1	The APBD clock for the TC6 is enabled.

**Bit 2 – TC5: TC5 APBD Mask Clock Enable**

Value	Description
0	The APBD clock for the TC5 is stopped.
1	The APBD clock for the TC5 is enabled.

**Bit 1 – SERCOM7: SERCOM7 APBD Mask Clock Enable**

Value	Description
0	The APBD clock for the SERCOM7 is stopped.
1	The APBD clock for the SERCOM7 is enabled.

**Bit 0 – SERCOM6: SERCOM6 APBD Mask Clock Enable**

Value	Description
0	The APBD clock for the SERCOM6 is stopped.
1	The APBD clock for the SERCOM6 is enabled.

## 19. RSTC – Reset Controller

### 19.1 Overview

The Reset Controller (RSTC) manages the reset of the microcontroller. It issues a microcontroller reset, sets the device to its initial state and allows the reset source to be identified by software.

### 19.2 Features

- Reset the microcontroller and set it to an initial state according to the reset source
- Reset cause register for reading the reset source from the application code
- Multiple reset sources
  - Power supply reset sources: POR, BODCORE, BODVDD
  - User reset sources: External reset ( $\overline{\text{RESET}}$ ), Watchdog reset, and System Reset Request

### 19.3 Block Diagram

Figure 19-1. Reset System



### 19.4 Signal Description

Signal Name	Type	Description
$\overline{\text{RESET}}$	Digital input	External reset

One signal can be mapped on several pins.

#### Related Links

[I/O Multiplexing and Considerations](#)

### 19.5 Product Dependencies

In order to use this peripheral, other parts of the system must be configured correctly, as described below.

## 19.5.1 I/O Lines

Not applicable.

## 19.5.2 Power Management

The Reset Controller module is always on.

## 19.5.3 Clocks

The RSTC bus clock (CLK\_RSTC\_APB) can be enabled and disabled in the Main Clock Controller.

### Related Links

[MCLK – Main Clock](#)

[Peripheral Clock Masking](#)

## 19.5.4 DMA

Not applicable.

## 19.5.5 Interrupts

Not applicable.

## 19.5.6 Events

Not applicable.

## 19.5.7 Debug Operation

When the CPU is halted in debug mode, the RSTC continues normal operation.

## 19.5.8 Register Access Protection

All registers with write-access can be optionally write-protected by the Peripheral Access Controller (PAC).

**Note:** Optional write-protection is indicated by the "PAC Write-Protection" property in the register description.

When the CPU is halted in debug mode, all write-protection is automatically disabled. Write-protection does not apply for accesses through an external debugger.

## 19.5.9 Analog Connections

Not applicable.

## 19.6 Functional Description

### 19.6.1 Principle of Operation

The Reset Controller collects the various Reset sources and generates Reset for the device.

### 19.6.2 Basic Operation

#### 19.6.2.1 Initialization

After a power-on Reset, the RSTC is enabled and the Reset Cause (RCAUSE) register indicates the POR source.

#### 19.6.2.2 Enabling, Disabling, and Resetting

The RSTC module is always enabled.

### 19.6.2.3 Reset Causes and Effects

The latest Reset cause is available in RCAUSE register, and can be read during the application boot sequence in order to determine proper action.

These are the groups of Reset sources:

- Power supply Reset: Resets caused by an electrical issue. It covers POR and BODs Resets
- User Reset: Resets caused by the application. It covers external Resets, system Reset requests and watchdog Resets

The following table lists the parts of the device that are reset, depending on the Reset type.

**Table 19-1. Effects of the Different Reset Causes**

	Power Supply Reset		User Reset		Backup Reset
	POR, BODVDD	BODCORE	External Reset	WDT Reset, System Reset Request	RTC, BBPS
RTC, OSC32KCTRL, RSTC, CTRLA.IORET bit of PM	Y	N	N	N	N
GCLK with WRTLOCK	Y	Y	N	N	Y
Debug logic	Y	Y	Y	N	Y
Others	Y	Y	Y	Y	N

The external Reset is generated when pulling the  $\overline{\text{RESET}}$  pin low.

The POR, BODCORE, and BODVDD Reset sources are generated by their corresponding module in the Supply Controller Interface (SUPC).

The WDT Reset is generated by the Watchdog Timer.

The System Reset Request is a Reset generated by the CPU when asserting the SYSRESETREQ bit located in the Reset Control register of the CPU (for details refer to the ARM<sup>®</sup> Cortex<sup>™</sup> Technical Reference Manual on <http://www.arm.com>).

#### Related Links

[SUPC – Supply Controller](#)

### 19.6.3 Additional Features

Not applicable.

### 19.6.4 DMA Operation

Not applicable.

### 19.6.5 Interrupts

Not applicable.

### 19.6.6 Events

Not applicable.

## 19.6.7 Sleep Mode Operation

The RSTC module is active in all sleep modes.



## 19.7 Register Summary

Offset	Name	Bit Pos.								
0x00	RCAUSE	7:0		SYST	WDT	EXT		BODVDD	BODCORE	POR

## 19.8 Register Description

Registers can be 8, 16, or 32 bits wide. Atomic 8-, 16- and 32-bit accesses are supported. In addition, the 8-bit quarters and 16-bit halves of a 32-bit register, and the 8-bit halves of a 16-bit register can be accessed directly.

Some registers are optionally write-protected by the Peripheral Access Controller (PAC). Optional PAC write-protection is denoted by the "PAC Write-Protection" property in each individual register description. For details, refer to [Register Access Protection](#).

### 19.8.1 Reset Cause

When a Reset occurs, the bit corresponding to the Reset source is set to '1' and all other bits are written to '0'.

**Name:** RCAUSE  
**Offset:** 0x00 [ID-0000052b]  
**Reset:** Latest Reset Source  
**Property:** –

Bit	7	6	5	4	3	2	1	0
		SYST	WDT	EXT		BODVDD	BODCORE	POR
Access		R	R	R		R	R	R
Reset		x	x	x		x	x	x

#### Bit 6 – SYST: System Reset Request

This bit is set if a System Reset Request has occurred. Refer to the Cortex processor documentation for more details.

#### Bit 5 – WDT: Watchdog Reset

This bit is set if a Watchdog Timer Reset has occurred.

#### Bit 4 – EXT: External Reset

This bit is set if an external Reset has occurred.

#### Bit 2 – BODVDD: Brown Out VDD Detector Reset

This bit is set if a BODVDD Reset has occurred.

#### Bit 1 – BODCORE: Brown Out CORE Detector Reset

This bit is set if a BODCORE Reset has occurred.

#### Bit 0 – POR: Power On Reset

This bit is set if a POR has occurred.

## 20. PM – Power Manager

### 20.1 Overview

The Power Manager (PM) controls the sleep modes of the device.

Various sleep modes are provided in order to fit power consumption requirements. This enables the PM to stop unused modules in order to save power. In active mode, the CPU is executing application code. When the device enters a sleep mode, program execution is stopped and some modules and clock domains are automatically switched off by the PM according to the sleep mode. The application code decides which sleep mode to enter and when. Interrupts from enabled peripherals and all enabled reset sources can restore the device from a sleep mode to active mode.

### 20.2 Features

- Power management control
  - Sleep modes: Idle, Standby

### 20.3 Block Diagram

Figure 20-1. PM Block Diagram



### 20.4 Signal Description

Not applicable.

### 20.5 Product Dependencies

In order to use this peripheral, other parts of the system must be configured correctly, as described below.

#### 20.5.1 I/O Lines

Not applicable.

#### 20.5.2 Clocks

The PM bus clock (CLK\_PM\_APB) can be enabled and disabled in the Main Clock module. If this clock is disabled, it can only be re-enabled by a system reset.

#### 20.5.3 DMA

Not applicable.

## 20.5.4 Interrupts

The interrupt request line is connected to the interrupt controller. Using the PM interrupt requires the interrupt controller to be configured first.

## 20.5.5 Events

Not applicable.

## 20.5.6 Debug Operation

When the CPU is halted in debug mode, the PM continues normal operation. If standby sleep mode is requested by the system while in debug mode, the power domains are not turned off. As a consequence, power measurements while in debug mode are not relevant.

Hot plugging in standby mode is supported.

## 20.5.7 Register Access Protection

Registers with write-access can be write-protected optionally by the peripheral access controller (PAC).

Optional PAC Write-Protection is denoted by the "PAC Write-Protection" property in each individual register description.

Write-protection does not apply to accesses through an external debugger.

## 20.5.8 Analog Connections

Not applicable.

## 20.6 Functional Description

### 20.6.1 Terminology

The following is a list of terms used to describe the Power Management features of this microcontroller.

#### 20.6.1.1 Sleep Modes

The device can be set in a sleep mode. In sleep mode, the CPU is stopped and the peripherals are either active or idle, according to the sleep mode depth:

- Idle sleep mode: The CPU is stopped. Synchronous clocks are stopped except when requested. The logic is retained.
- Standby sleep mode: The CPU is stopped as well as the peripherals.

### 20.6.2 Principle of Operation

In active mode, all clock domains and power domains are active, allowing software execution and peripheral operation. The PM Sleep Mode Controller allows to save power by choosing between different sleep modes depending on application requirements, see [Sleep Mode Controller](#).

The PM Power Domain Controller allows to reduce the power consumption in standby mode even further.

### 20.6.3 Basic Operation

#### 20.6.3.1 Initialization

After a power-on reset, the PM is enabled, the device is in ACTIVE mode.

#### 20.6.3.2 Enabling, Disabling and Resetting

The PM is always enabled and can not be reset.

## 20.6.3.3 Sleep Mode Controller

A Sleep mode is entered by executing the Wait For Interrupt instruction (WFI). The Sleep Mode bits in the Sleep Configuration register (SLEEPCFG.SLEEPMODE) select the level of the sleep mode.

**Note:** A small latency happens between the store instruction and actual writing of the SLEEPCFG register due to bridges. Software must ensure that the SLEEPCFG register reads the desired value before issuing a WFI instruction.

**Table 20-1. Sleep Mode Entry and Exit Table**

Mode	Mode Entry	Wake-Up Sources
IDLE	SLEEPCFG.SLEEPMODE = IDLE	Synchronous <sup>(2)</sup> (APB, AHB), asynchronous <sup>(1)</sup>
STANDBY	SLEEPCFG.SLEEPMODE = STANDBY	Synchronous <sup>(3)</sup> , Asynchronous

**Note:**

1. Asynchronous: interrupt generated on generic clock, external clock, or external event.
2. Synchronous: interrupt generated on the APB clock.
3. Synchronous interrupt only for peripherals configured to run in standby.

**Note:** The type of wake-up sources (synchronous or asynchronous) is given in each module interrupt section.

The sleep modes (idle, standby) and their effect on the clocks activity, the regulator and the NVM state are described in the table and the sections below.

**Table 20-2. Sleep Mode Overview**

Mode	CPU clock	AHB clock	APB clock	Main clock	GCLK clocks	Oscillators		Regulator	RAM
						ONDEMAND = 0	ONDEMAND = 1		
IDLE	Stop	Stop <sup>(2)</sup>	Stop <sup>(2)</sup>	Run	Run <sup>(1)</sup>	Run	Run if requested	Main	Normal
STANDBY	Stop	Stop <sup>(2)</sup>	Stop <sup>(2)</sup>	Stop	Stop <sup>(2)</sup>	Run if requested or RUNSTDBY=1	Run if requested	LPVREG <sup>(3)</sup>	Low power <sup>(4)</sup>

**Note:**

1. Running if requested by peripheral.
2. Running during SleepWalking.
3. Regulator state is programmable by using STDBYCFG.VREGSMOD bits.
4. RAM state is programmable by using STDBYCFG.BBIASHS bit.

**IDLE Mode**

The IDLE mode allows power optimization with the fastest wake-up time.

The CPU is stopped. To further reduce power consumption, the user can disable the clocking of modules and clock sources by configuring the SLEEPCFG bit group to IDLE. The peripheral will be halted regardless of the bit settings of the mask registers in the MCLK (MCLK.AHBMASK, MCLK.APBxMASK).

- Entering IDLE mode: The IDLE mode is entered by executing the WFI instruction. Additionally, if the SLEEPONEXIT bit in the ARM Cortex System Control register (SCR) is set, the IDLE mode will also be entered when the CPU exits the lowest priority ISR. This mechanism can be useful for applications that only require the processor to run when an interrupt occurs. Before entering the IDLE mode, the user must configure the Sleep Configuration register.

- Exiting IDLE mode: The processor wakes the system up when it detects any non-masked interrupt with sufficient priority to cause exception entry. The system goes back to the ACTIVE mode. The CPU and affected modules are restarted.

Regulator operates in normal mode.

## STANDBY Mode

The STANDBY mode is the lowest power configuration while keeping the state of the logic and the content of the RAM.

In this mode, all clocks are stopped except those which are kept running if requested by a running peripheral or have the ONDEMAND bit written to "0". For example, the RTC can operate in STANDBY mode. In this case, its GCLK clock source will also be enabled.

All features that don't require CPU intervention are supported in STANDBY mode. Here are examples:

- Autonomous peripherals features.
- Features relying on Event System allowing autonomous communication between peripherals.
- Features relying on on-demand clock.
- DMA transfers.
- Entering STANDBY mode: This mode is entered by executing the WFI instruction with the SLEEP\_CFG register written to STANDBY. The SLEEPONEXIT feature is also available as in IDLE mode.
- Exiting STANDBY mode: Any peripheral able to generate an asynchronous interrupt can wake up the system. For example, a peripheral running on a GCLK clock can trigger an interrupt. When the enabled asynchronous wake-up event occurs and the system is woken up, the device will either execute the interrupt service routine or continue the normal program execution according to the Priority Mask Register (PRIMASK) configuration of the CPU.

Depending on the configuration of these modules, the current consumption of the device in STANDBY mode can be slightly different.

The regulator operates in low-power mode (LP VREG) by default and can switch automatically to the main regulator if a task required by a peripheral requires more power. It returns automatically in the low power mode as soon as the task is completed.

## 20.6.4 Advanced Features

### 20.6.4.1 RAM Automatic Low Power Mode

The RAM is by default put in low power mode (back-biased) if the device is in standby sleep mode.

This behavior can be changed by configuring the Back Bias bit in the Standby Configuration register (STDBY\_CFG.BBIASHS), refer to the table below for details.

**Note:** In standby sleep mode, the RAM is put in low-power mode by default. This means that the RAM is back-biased, and the DMAC cannot access it. The DMAC can only access the RAM when it is not back biased (PM.STDBY\_CFG.BBIASHS=0x0).

**Table 20-3. RAM Back-Biasing Mode**

STBY_CFG.BBIASHS	RAM	
0x0	No Back Biasing	RAM is not back-biased if the device is in standby sleep mode.
0x1	Standby Back Biasing mode	RAM is back-biased if the device is in standby sleep mode.

## 20.6.4.2 Regulator Automatic Low Power Mode

In standby mode, the PM selects either the main or the low power voltage regulator to supply the VDDCORE. By default the low power voltage regulator is used.

If a sleepwalking task is working on either asynchronous clocks (generic clocks) or synchronous clock (APB/AHB clocks), the main voltage regulator is used. This behavior can be changed by writing the Voltage Regulator Standby Mode bits in the Standby Configuration register (STDBYCFG.VREGSMOD). Refer to the following table for details.

**Table 20-4. Regulator State in Sleep Mode**

Sleep Mode	STDBYCFG.VREGSMOD	SleepWalking	Regulator state for VDDCORE
Active	-	-	main voltage regulator
Idle	-	-	main voltage regulator
Standby	0x0: AUTO	NO	low power regulator
		YES	main voltage regulator
	0x1: PERFORMANCE	-	main voltage regulator
	0x2: LP	-	low power regulator

## 20.6.5 DMA Operation

Not applicable.

## 20.6.6 Interrupts

Not applicable.

## 20.6.7 Events

Not applicable.

## 20.6.8 Sleep Mode Operation

The Power Manager is always active.

## 20.7 Register Summary

Offset	Name	Bit Pos.								
0x01	SLEEPCFG	7:0						SLEEPMODE[2:0]		
0x02	Reserved									
...										
0x07										
0x08	STDBYCFG	7:0	VREGSMOD[1:0]							
0x09		15:8					BBIASHS			

## 20.8 Register Description

Registers can be 8, 16, or 32 bits wide. Atomic 8-, 16- and 32-bit accesses are supported. In addition, the 8-bit quarters and 16-bit halves of a 32-bit register, and the 8-bit halves of a 16-bit register can be accessed directly.

Some registers are optionally write-protected by the Peripheral Access Controller (PAC). Optional PAC write-protection is denoted by the "PAC Write-Protection" property in each individual register description. For details, refer to [Register Access Protection](#).

### 20.8.1 Sleep Configuration

**Name:** SLEEPCFG  
**Offset:** 0x01 [ID-00000a2f]  
**Reset:** 0x00  
**Property:** PAC Write-Protection

Bit	7	6	5	4	3	2	1	0
						SLEEPMODE[2:0]		
Access						R/W	R/W	R/W
Reset						0	0	0

#### Bits 2:0 – SLEEPMODE[2:0]: Sleep Mode

**Note:** A small latency happens between the store instruction and actual writing of the SLEEPCFG register due to bridges. Software has to make sure the SLEEPCFG register reads the wanted value before issuing Wait For Interrupt (WFI) instruction.

Value	Name	Definition
0x0	Reserved	Reserved
0x1	Reserved	Reserved
0x2	IDLE	CPU, AHBx and APBx clocks are OFF
0x3	Reserved	Reserved
0x4	STANDBY	ALL clocks are OFF, unless requested by sleepwalking peripheral
0x5 - 0x7	Reserved	Reserved

## 20.8.2 Standby Configuration

**Name:** STDBYCFG  
**Offset:** 0x08 [ID-00000a2f]  
**Reset:** 0x0400  
**Property:** PAC Write-Protection



### Bit 10 – BBIASHS: Back Bias for HMCGRAMCHS

Refer to [RAM Automatic Low Power Mode](#) for details.

Value	Description
0	No Back Biasing Mode
1	Standby Back Biasing Mode

### Bits 7:6 – VREGSMOD[1:0]: VREG Switching Mode

Refer to for [Regulator Automatic Low Power Mode](#) details.

Value	Name	Description
0x0	AUTO	Automatic Mode
0x1	PERFORMANCE	Performance oriented
0x2	LP	Low Power consumption oriented
0x9	Reserved	Reserved



## 21. OSCCTRL – Oscillators Controller

### 21.1 Overview

The Oscillators Controller (OSCCTRL) provides a user interface to the XOSC, OSC48M and FDPLL96M.

Through the interface registers, it is possible to enable, disable, calibrate, and monitor the OSCCTRL sub-peripherals.

All sub-peripheral statuses are collected in the Status register (STATUS). They can additionally trigger interrupts upon status changes via the INTENSET, INTENCLR, and INTFLAG registers.

#### Related Links

[INTENCLR](#)

[INTENSET](#)

[INTFLAG](#)

[STATUS](#)

### 21.2 Features

- 0.4-32MHz Crystal Oscillator (XOSC)
  - Tunable gain control
  - Programmable start-up time
  - Crystal or external input clock on XIN I/O
  - Clock failure detection with safe clock switch
  - Clock failure event output
- 48MHz Internal Oscillator (OSC48M)
  - Fast start-up
  - Programmable start-up time
  - 4-bit linear divider available
- Fractional Digital Phase Locked Loop (FDPLL96M)
  - 48MHz to 96MHz output frequency
  - 32kHz to 2MHz reference clock
  - A selection of sources for the reference clock
  - Adjustable proportional integral controller
  - Fractional part used to achieve 1/16th of reference clock step

## 21.3 Block Diagram

Figure 21-1. OSCCTRL Block Diagram



## 21.4 Signal Description

Signal	Description	Type
XIN	Multipurpose Crystal Oscillator or external clock generator input	Analog input
XOUT	Multipurpose Crystal Oscillator output	Analog output

The I/O lines are automatically selected when XOSC is enabled.

## 21.5 Product Dependencies

In order to use this peripheral, other parts of the system must be configured correctly, as described below.

### 21.5.1 I/O Lines

I/O lines are configured by OSCCTRL when XOSC is enabled, and need no user configuration.

### 21.5.2 Power Management

The OSCCTRL can continue to operate in any sleep mode where the selected source clock is running. The OSCCTRL interrupts can be used to wake up the device from sleep modes. The events can trigger other operations in the system without exiting sleep modes.

#### Related Links

[PM – Power Manager](#)

### 21.5.3 Clocks

The OSCCTRL gathers controls for all device oscillators and provides clock sources to the Generic Clock Controller (GCLK). The available clock sources are: XOSC, OSC48M and FDPLL96M.

The OSCCTRL bus clock (CLK\_OSCCTRL\_APB) can be enabled and disabled in the Main Clock module (MCLK).

The OSC48M control logic uses the oscillator output, which is also asynchronous to the user interface clock (CLK\_OSCCTRL\_APB). Due to this asynchronicity, writes to certain registers will require synchronization between the clock domains. Refer to [Synchronization](#) for further details.

## Related Links

[MCLK – Main Clock](#)

[Peripheral Clock Masking](#)

### 21.5.4 DMA

Not applicable.

### 21.5.5 Interrupts

The interrupt request line is connected to the Interrupt Controller. Using the OSCCTRL interrupts requires the interrupt controller to be configured first.

## Related Links

[Nested Vector Interrupt Controller](#)

[INTFLAG](#)

[Sleep Mode Controller](#)

### 21.5.6 Events

The events of this peripheral are connected to the Event System.

## Related Links

[EVSYS – Event System](#)

### 21.5.7 Debug Operation

When the CPU is halted in debug mode the OSCCTRL continues normal operation. If the OSCCTRL is configured in a way that requires it to be periodically serviced by the CPU through interrupts or similar, improper operation or data loss may result during debugging.

### 21.5.8 Register Access Protection

All registers with write-access can be write-protected optionally by the Peripheral Access Controller (PAC), except for the following registers:

- Interrupt Flag Status and Clear register (INTFLAG)

**Note:** Optional write-protection is indicated by the "PAC Write-Protection" property in the register description.

When the CPU is halted in debug mode, all write-protection is automatically disabled. Write-protection does not apply for accesses through an external debugger.

### 21.5.9 Analog Connections

The 0.4-32MHz crystal must be connected between the XIN and XOUT pins, along with any required load capacitors.

## 21.6 Functional Description

### 21.6.1 Principle of Operation

XOSC, OSC48M and FDPLL96M are configured via OSCCTRL control registers. Through this interface, the sub-peripherals are enabled, disabled, or have their calibration values updated.

The Status register gathers different status signals coming from the sub-peripherals controlled by the OSCCTRL. The status signals can be used to generate system interrupts, and in some cases wake up the system from standby mode, provided the corresponding interrupt is enabled.

## 21.6.2 External Multipurpose Crystal Oscillator (XOSC) Operation

The XOSC can operate in two different modes:

- External clock, with an external clock signal connected to the XIN pin
- Crystal oscillator, with an external 0.4-32MHz crystal

The XOSC can be used as a clock source for generic clock generators. This is configured by the Generic Clock Controller.

At reset, the XOSC is disabled, and the XIN/XOUT pins can be used as General Purpose I/O (GPIO) pins or by other peripherals in the system. When XOSC is enabled, the operating mode determines the GPIO usage. When in crystal oscillator mode, the XIN and XOUT pins are controlled by the OSCCTRL, and GPIO functions are overridden on both pins. When in external clock mode, only the XIN pin will be overridden and controlled by the OSCCTRL, while the XOUT pin can still be used as a GPIO pin.

The XOSC is enabled by writing a '1' to the Enable bit in the External Multipurpose Crystal Oscillator Control register (XOSCCTRL.ENABLE).

To enable XOSC as an external crystal oscillator, the XTAL Enable bit (XOSCCTRL.XTALEN) must be written to '1'. If XOSCCTRL.XTALEN is zero, the external clock input on XIN will be enabled.

When in crystal oscillator mode (XOSCCTRL.XTALEN=1), the External Multipurpose Crystal Oscillator Gain (XOSCCTRL.GAIN) must be set to match the external crystal oscillator frequency. If the External Multipurpose Crystal Oscillator Automatic Amplitude Gain Control (XOSCCTRL.AMPGC) is '1', the oscillator amplitude will be automatically adjusted, and in most cases result in a lower power consumption.

The XOSC will behave differently in different sleep modes, based on the settings of XOSCCTRL.RUNSTDBY, XOSCCTRL.ONDEMAND, and XOSCCTRL.ENABLE. If XOSCCTRL.ENABLE=0, the XOSC will be always stopped. For XOSCCTRL.ENABLE=1, this table is valid:

**Table 21-1. XOSC Sleep Behavior**

CPU Mode	XOSCCTRL.RUNSTDBY	XOSCCTRL.ONDEMAND	Sleep Behavior
Active or Idle	-	0	Always run
Active or Idle	-	1	Run if requested by peripheral
Standby	1	0	Always run
Standby	1	1	Run if requested by peripheral
Standby	0	-	Run if requested by peripheral

After a hard reset, or when waking up from a sleep mode where the XOSC was disabled, the XOSC will need a certain amount of time to stabilize on the correct frequency. This start-up time can be configured by changing the Oscillator Start-Up Time bit group (XOSCCTRL.STARTUP) in the External Multipurpose Crystal Oscillator Control register. During the start-up time, the oscillator output is masked to ensure that no unstable clock propagates to the digital logic.

The External Multipurpose Crystal Oscillator Ready bit in the Status register (STATUS.XOSCRDY) is set once the external clock or crystal oscillator is stable and ready to be used as a clock source. An interrupt is generated on a zero-to-one transition on STATUS.XOSCRDY if the External Multipurpose Crystal Oscillator Ready bit in the Interrupt Enable Set register (INTENSET.XOSCRDY) is set.

## Related Links

[GCLK - Generic Clock Controller](#)

### 21.6.3 Clock Failure Detection Operation

The Clock Failure Detector (CFD) allows the user to monitor the external clock or crystal oscillator signal provided by the external oscillator (XOSC). The CFD detects failing operation of the XOSC clock with reduced latency, and allows to switch to a safe clock source in case of clock failure. The user can also switch from the safe clock back to XOSC in case of recovery. The safe clock is derived from the OSC48M oscillator with a configurable prescaler. This allows to configure the safe clock in order to fulfill the operative conditions of the microcontroller.

In sleep modes, CFD operation is automatically disabled when the external oscillator is not requested to run by a peripheral. See the Sleep Behavior table above when this is the case.

The user interface registers allow to enable, disable, and configure the CFD. The Status register provides status flags on failure and clock switch conditions. The CFD can optionally trigger an interrupt or an event when a failure is detected.

#### Clock Failure Detection

The CFD is reset only at power-on (POR). The CFD does not monitor the XOSC clock when the oscillator is disabled (XOSCCTRL.ENABLE=0).

Before starting CFD operation, the user must start and enable the safe clock source (OSC48M oscillator).

CFD operation is started by writing a '1' to the CFD Enable bit in the External Oscillator Control register (XOCTRL.CFDEN). After starting or restarting the XOSC, the CFD does not detect failure until the start-up time has elapsed. The start-up time is configured by the Oscillator Start-Up Time in the External Multipurpose Crystal Oscillator Control register (XOSCCTRL.STARTUP). Once the XOSC Start-Up Time is elapsed, the XOSC clock is constantly monitored.

During a period of 4 safe clocks (monitor period), the CFD watches for a clock activity from the XOSC. There must be at least one rising and one falling XOSC clock edge during 4 safe clock periods to meet non-failure conditions. If no or insufficient activity is detected, the failure status is asserted: The Clock Failure Detector status bit in the Status register (STATUS.CLKFAIL) and the Clock Failure Detector interrupt flag bit in the Interrupt Flag register (INTFLAG.CLKFAIL) are set. If the CLKFAIL bit in the Interrupt Enable Set register (INTENSET.CLKFAIL) is set, an interrupt is generated as well. If the Event Output enable bit in the Event Control register (EVCTRL.CFDEO) is set, an output event is generated, too.

After a clock failure was issued the monitoring of the XOSC clock is continued, and the Clock Failure Detector status bit in the Status register (STATUS.CLKFAIL) reflects the current XOSC activity.

#### Clock Switch

When a clock failure is detected, the XOSC clock is replaced by the safe clock in order to maintain an active clock during the XOSC clock failure. The safe clock source is the OSC48M oscillator clock. The safe clock source can be scaled down by a configurable prescaler to ensure that the safe clock frequency does not exceed the operating conditions selected by the application. When the XOSC clock is switched to the safe clock, the Clock Switch bit in the Status register (STATUS.CLKSW) is set.

When the CFD has switched to the safe clock, the XOSC is not disabled. If desired, the application must take the necessary actions to disable the oscillator. The application must also take the necessary actions to configure the system clocks to continue normal operations.

In the case the application can recover the XOSC, the application can switch back to the XOSC clock by writing a '1' to Switch Back Enable bit in the Clock Failure Control register (XOSCCTRL.SWBACK). Once the XOSC clock is switched back, the Switch Back bit (XOSCCTRL.SWBACK) is cleared by hardware.

### Prescaler

The CFD has an internal configurable prescaler to generate the safe clock from the OSC48M oscillator. The prescaler size allows to scale down the OSC48M oscillator so the safe clock frequency is not higher than the XOSC clock frequency monitored by the CFD. The division factor is  $2^P$ , with P being the value of the CFD Prescaler bits in the CFD Prescaler Register (CFDPRESC.CFDPRESC).

#### Example

For an external crystal oscillator at 0.4MHz and the OSC48M frequency at 16MHz, the CFDPRESC.CFDPRESC value should be set scale down by more than factor  $16/0.4=80$ , e.g. to 128, for a safe clock of adequate frequency.

### Event

If the Event Output Enable bit in the Event Control register (EVCTRL.CFDEO) is set, the CFD clock failure will be output on the Event Output. When the CFD is switched to the safe clock, the CFD clock failure will not be output on the Event Output.

### Sleep Mode

The CFD is halted depending on configuration of the XOSC and the peripheral clock request. For further details, refer to the Sleep Behavior table above. The CFD interrupt can be used to wake up the device from sleep modes.

## 21.6.4 48MHz Internal Oscillator (OSC48M) Operation

The OSC48M is an internal oscillator operating in open-loop mode and generating 48MHz frequency. The OSC48M frequency is selected by writing to the Division Factor field in the OSC48MDIV register (OSC48MDIV.DIV). OSC48M is enabled by writing '1' to the Oscillator Enable bit in the OSC48M Control register (OSC48MCTRL.ENABLE), and disabled by writing a '0' to this bit.

After enabling OSC48M, the OSC48M clock is output as soon as the oscillator is ready (STATUS.OSC48MRDY=1). User must ensure that the OSC48M is fully disabled before enabling it by reading STATUS.OSC48MRDY=0.

After reset, OSC48M is enabled and serves as the default clock source at 4MHz.

OSC48M will behave differently in different sleep modes based on the settings of OSC48MCTRL.RUNSTDBY, OSC48MCTRL.ONDEMAND, and OSC48MCTRL.ENABLE. If OSC48MCTRL.ENABLE=0, the OSC48M will be always stopped. For OSC48MCTRL.ENABLE=1, this table is valid:

**Table 21-2. OSC48M Sleep Behavior**

CPU Mode	OSC48MCTRL.RUNSTDBY	OSC48MCTRL.ONDEMAND	Sleep Behavior
Active or Idle	-	0	Always run
Active or Idle	-	1	Run if requested by peripheral
Standby	1	0	Always run

CPU Mode	OSC48MCTRL.RUN STDBY	OSC48MCTRL.OND EMAND	Sleep Behavior
Standby	1	1	Run if requested by peripheral
Standby	0	-	Run if requested by peripheral

After a hard reset, or when waking up from a sleep mode where the OSC48M was disabled, the OSC48M will need a certain amount of time to stabilize on the correct frequency. This start-up time can be configured by changing the Oscillator Start-Up Delay bit group (OSC48MSTUP.STARTUP) in the OSC48M Startup register. During the start-up time, the oscillator output is masked to ensure that no unstable clock propagates to the digital logic. The OSC48M Ready bit in the Status register (STATUS.OSC48MRDY) is set when the oscillator is stable and ready to be used as a clock source. An interrupt is generated on a zero-to-one transition on STATUS.OSC48MRDY if the OSC48M Ready bit in the Interrupt Enable Set register (INTENSET.OSC48MRDY) is set.

Faster start-up times are achievable by selecting shorter delays. However, the oscillator frequency may not stabilize within tolerances when short delays are used. If a fast start-up time is desired at the expense of initial accuracy, the division factor should be set to two or higher (OSC48MDIV.DIV > 0).

The OSC48M is used as a clock source for the generic clock generators.

#### Related Links

[GCLK - Generic Clock Controller](#)

### 21.6.5 Digital Phase Locked Loop (DPLL) Operation

The task of the DPLL is to maintain coherence between the input (reference) signal and the respective output frequency, CLK\_DPLL, via phase comparison. The DPLL controller supports three independent sources of reference clocks:

- XOSC32K: this clock is provided by the 32K External Crystal Oscillator (XOSC32K).
- XOSC: this clock is provided by the External Multipurpose Crystal Oscillator (XOSC).
- GCLK: this clock is provided by the Generic Clock Controller.

When the controller is enabled, the relationship between the reference clock frequency and the output clock frequency is:

$$f_{CK} = f_{CKR} \times \left( LDR + 1 + \frac{LDRFRAC}{16} \right) \times \frac{1}{2^{PRESC}}$$

Where  $f_{CK}$  is the frequency of the DPLL output clock, LDR is the loop divider ratio integer part, LDRFRAC is the loop divider ratio fractional part,  $f_{CKR}$  is the frequency of the selected reference clock, and PRESC is the output prescaler value.

**Figure 21-2. DPLL Block Diagram**



When the controller is disabled, the output clock is low. If the Loop Divider Ratio Fractional part bit field in the DPLL Ratio register (DPLLCTRLB.LDRFRAC) is zero, the DPLL works in integer mode. Otherwise, the fractional mode is activated. Note that the fractional part has a negative impact on the jitter of the DPLL.

Example (integer mode only): assuming  $F_{CKR} = 32\text{kHz}$  and  $F_{CK} = 48\text{MHz}$ , the multiplication ratio is 1500. It means that LDR shall be set to 1499.

Example (fractional mode): assuming  $F_{CKR} = 32\text{kHz}$  and  $F_{CK} = 48.006\text{MHz}$ , the multiplication ratio is 1500.1875 ( $1500 + 3/16$ ). Thus LDR is set to 1499 and LDRFRAC to 3.

### Related Links

[GCLK - Generic Clock Controller](#)

[OSC32KCTRL – 32KHz Oscillators Controller](#)

## 21.6.5.1 Basic Operation

### Initialization, Enabling, Disabling, and Resetting

The DPLL is enabled by writing a '1' to the Enable bit in the DPLL Control A register (DPLLCTRLA.ENABLE). The DPLL is disabled by writing a zero to this bit.

The DPLLSYNCBUSY.ENABLE is set when the DPLLCTRLA.ENABLE bit is modified. It is cleared when the DPLL output clock CK has sampled the bit at the high level after enabling the DPLL. When disabling the DPLL, DPLLSYNCBUSY.ENABLE is cleared when the output clock is no longer running.

### Figure 21-3. Enable Synchronization Busy Operation

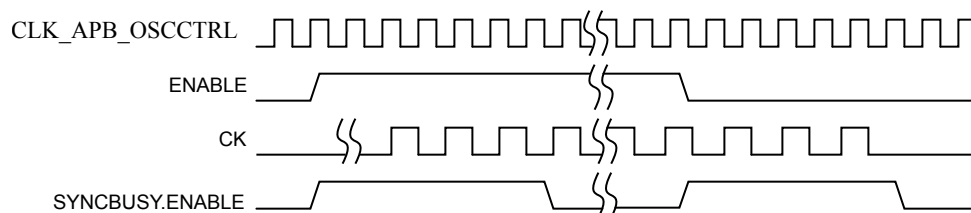

The frequency of the DPLL output clock CK is stable when the module is enabled and when the Lock bit in the DPLL Status register is set (DPLLSTATUS.LOCK).

When the Lock Time bit field in the DPLL Control B register (DPLLCTRLB.LTIME) is non-zero, a user defined lock time is used to validate the lock operation. In this case the lock time is constant. If DPLLCTRLB.LTIME=0, the lock signal is linked with the status bit of the DPLL, and the lock time varies depending on the filter selection and the final target frequency.



When the Wake Up Fast bit (DPLLCTRLB.WUF) is set, the wake up fast mode is activated. In this mode the clock gating cell is enabled at the end of the startup time. At this time the final frequency is not stable, as it is still during the acquisition period, but it allows to save several milliseconds. After first acquisition, the Lock Bypass bit (DPLLCTRLB.LBYPASS) indicates if the lock signal is discarded from the control of the clock gater (CG) generating the output clock CLK\_DPLL.

**Table 21-3. CLK\_DPLL Behavior from Startup to First Edge Detection**

WUF	LTIME	CLK_DPLL Behavior
0	0	Normal Mode: First Edge when lock is asserted
0	Not Equal To Zero	Lock Timer Timeout mode: First Edge when the timer down-counts to 0.
1	X	Wake Up Fast Mode: First Edge when CK is active (startup time)

**Table 21-4. CLK\_DPLL Behavior after First Edge Detection**

LBYPASS	CLK_DPLL Behavior
0	Normal Mode: the CLK_DPLL is turned off when lock signal is low.
1	Lock Bypass Mode: the CLK_DPLL is always running, lock is irrelevant.

**Figure 21-4. CK and CLK\_DPLL Output from DPLL Off Mode to Running Mode**



### Reference Clock Switching

When a software operation requires reference clock switching, the recommended procedure is to turn the DPLL into the standby mode, modify the DPLLCTRLB.REFCLK to select the desired reference source, and activate the DPLL again.

### Output Clock Prescaler

The DPLL controller includes an output prescaler. This prescaler provides three selectable output clocks CK, CKDIV2 and CKDIV4. The Prescaler bit field in the DPLL Prescaler register (DPLLPRESC.PRESC) is used to select a new output clock prescaler. When the prescaler field is modified, the DPLLSYNCBUSY.DPLLPRESC bit is set. It will be cleared by hardware when the synchronization is over.

Figure 21-5. Output Clock Switching Operation



**Loop Divider Ratio Updates**

The DPLL Controller supports on-the-fly update of the DPLL Ratio Control (DPLLRATIO) register, allowing to modify the loop divider ratio and the loop divider ratio fractional part when the DPLL is enabled.

STATUS.DPLLLDRTO is set when the DPLLRATIO register has been modified and the DPLL analog cell has successfully sampled the updated value. At that time the DPLLSTATUS.LOCK bit is cleared and set again by hardware when the output frequency reached a stable state.

Figure 21-6. RATIOCTRL register update operation



**Digital Filter Selection**

The PLL digital filter (PI controller) is automatically adjusted in order to provide a good compromise between stability and jitter. Nevertheless a software operation can override the filter setting using the Filter bit field in the DPLL Control B register (DPLLCTRLB.FILTER). The Low Power Enable bit (DPLLCTRLB.LPEN) can be used to bypass the Time to Digital Converter (TDC) module.

**21.6.6 DMA Operation**

Not applicable.

**21.6.7 Interrupts**

The OSCCTRL has the following interrupt sources:

- XOSCRDY - Multipurpose Crystal Oscillator Ready: A 0-to-1 transition on the STATUS.XOSCRDY bit is detected

- CLKFAIL - Clock Failure. A 0-to-1 transition on the STATUS.CLKFAIL bit is detected
- OSC48MRDY - 48MHz Internal Oscillator Ready: A 0-to-1 transition on the STATUS.OSC48MRDY bit is detected
- DPLL-related:
  - DPLLLOCKR - DPLL Lock Rise: A 0-to-1 transition of the STATUS.DPLLLOCKR bit is detected
  - DPLLLOCKF - DPLL Lock Fall: A 0-to-1 transition of the STATUS.DPLLLOCKF bit is detected
  - DPLLLTTO - DPLL Lock Timer Time-out: A 0-to-1 transition of the STATUS.DPLLLTTO bit is detected
  - DPLLLDRTO - DPLL Loop Divider Ratio Update Complete. A 0-to-1 transition of the STATUS.DPLLLDRTO bit is detected

All these interrupts are synchronous wake-up source.

Each interrupt source has an interrupt flag associated with it. The interrupt flag in the Interrupt Flag Status and Clear register (INTFLAG) is set when the interrupt condition occurs.

Each interrupt can be individually enabled by writing a '1' to the corresponding bit in the Interrupt Enable Set register (INTENSET), and disabled by writing a '1' to the corresponding bit in the Interrupt Enable Clear register (INTENCLR).

An interrupt request is generated when the interrupt flag is set and the corresponding interrupt is enabled. The interrupt request remains active until the interrupt flag is cleared, the interrupt is disabled, or the OSCCTRL is reset. See the INTFLAG register for details on how to clear interrupt flags.

The OSCCTRL has one common interrupt request line for all the interrupt sources. The user must read the INTFLAG register to determine which interrupt condition is present. Refer to the INTFLAG register for details.

**Note:** The interrupts must be globally enabled for interrupt requests to be generated.

## 21.6.8 Events

The CFD can generate the following output event:

- Clock Failure (CLKFAIL): Generated when the Clock Failure status bit is set in the Status register (STATUS.CLKFAIL). The CFD event is not generated when the Clock Switch bit (STATUS.CLKSW) in the Status register is set.

Writing a '1' to an Event Output bit in the Event Control register (EVCTRL.CFDEO) enables the CFD output event. Writing a '0' to this bit disables the CFD output event. Refer to the Event System chapter for details on configuring the event system.

## 21.6.9 Synchronization

### OSC48M

Due to the multiple clock domains, values in the OSC48M control registers need to be synchronized to other clock domains.

When executing an operation that requires synchronization, the relevant synchronization bit in the Synchronization Busy register (OSC48MSYNCBUSY) will be set immediately, and cleared when synchronization is complete.

The following registers need synchronization when written:

- OSC48M Divider register (OSC48MDIV)

## **DPLL96M**

Due to the multiple clock domains, some registers in the DPLL96M must be synchronized when accessed.

When executing an operation that requires synchronization, the relevant synchronization bit in the Synchronization Busy register (DPLLSYNCBUSY) will be set immediately, and cleared when synchronization is complete.

The following bits need synchronization when written:

- Enable bit in control register A (DPLLCTRLA.ENABLE)
- DPLL Ratio register (DPLLRATIO)
- DPLL Prescaler register (DPLLPRESC)

## **Related Links**

[Register Synchronization](#)

## 21.7 Register Summary

Offset	Name	Bit Pos.								
0x00	INTENCLR	7:0				OSC48MRDY			CLKFAIL	XOSCRDY
0x01		15:8					DPLLLDRTO	DPLLLTO	DPLLLCKF	DPLLLCKR
0x02		23:16								
0x03		31:24								
0x04	INTENSET	7:0				OSC48MRDY			CLKFAIL	XOSCRDY
0x05		15:8					DPLLLDRTO	DPLLLTO	DPLLLCKF	DPLLLCKR
0x06		23:16								
0x07		31:24								
0x08	INTFLAG	7:0				OSC48MRDY			CLKFAIL	XOSCRDY
0x09		15:8					DPLLLDRTO	DPLLLTO	DPLLLCKF	DPLLLCKR
0x0A		23:16								
0x0B		31:24								
0x0C	STATUS	7:0				OSC48MRDY		CLKSW	CLKFAIL	XOSCRDY
0x0D		15:8					DPLLLDRTO	DPLLLTO	DPLLLCKF	DPLLLCKR
0x0E		23:16								
0x0F		31:24								
0x10	XOSCCTRL	7:0	ONDEMAND	RUNSTDBY		SWBACK	CFDEN	XTALEN	ENABLE	
0x11		15:8	STARTUP[3:0]				AMPGC	GAIN[2:0]		
0x12	CFDPRESC	7:0					CFDPRESC[2:0]			
0x13	EVCTRL	7:0								CFDEO
0x14	OSC48MCTRL	7:0	ONDEMAND	RUNSTDBY					ENABLE	
0x15	OSC48MDIV	7:0					DIV[3:0]			
0x16	OSC48MSTUP	7:0					STARTUP[2:0]			
0x17	Reserved									
0x18	OSC48MSYNCBUS Y	7:0						OSC48MDIV		
0x19		15:8								
0x1A		23:16								
0x1B		31:24								
0x1C	DPLLCTRLA	7:0	ONDEMAND	RUNSTDBY					ENABLE	
0x1D	Reserved									
...										
0x1F										
0x20	DPLLRATIO	7:0	LDR[7:0]							
0x21		15:8	LDR[11:8]							
0x22		23:16	LDRFRAC[3:0]							
0x23		31:24								
0x24	DPLLCTRLB	7:0			REFCLK[1:0]	WUF	LPEN	FILTER[1:0]		
0x25		15:8			LBYPASS		LTIME[2:0]			
0x26		23:16	DIV[7:0]							
0x27		31:24	DIV[10:8]							
0x28	DPLLPRESC	7:0								PRESC[1:0]
0x29	Reserved									
...										
0x2B										

Offset	Name	Bit Pos.								
0x2C	DPLLSYNCBUSY	7:0					DPLLPRESC	DPLLRATIO	ENABLE	
0x2D	Reserved									
0x2F										
0x30	DPLLSTATUS	7:0							CLKRDY	LOCK
0x31	Reserved									
0x37										
0x38			7:0					FCAL[5:0]		
0x39	CAL48M								FRANGE[1:0]	
0x3A			15:8							
0x3B			23:16					TCAL[5:0]		
0x3B										
		31:24								

## 21.8 Register Description

Registers can be 8, 16, or 32 bits wide. Atomic 8-, 16-, and 32-bit accesses are supported. In addition, the 8-bit quarters and 16-bit halves of a 32-bit register and the 8-bit halves of a 16-bit register can be accessed directly.

Some registers are optionally write-protected by the Peripheral Access Controller (PAC). Write-protection is denoted by the "PAC Write-Protection" property in each individual register description. Refer to the [Register Access Protection](#) section and the [PAC - Peripheral Access Controller](#) chapter for details.

Some registers require synchronization when read and/or written. Synchronization is denoted by the "Read-Synchronized" or "Write.Synchronized" property in each individual register description. Refer to the Synchronization section for details.

### 21.8.1 Interrupt Enable Clear

This register allows the user to disable an interrupt without doing a read-modify-write operation. Changes in this register will also be reflected in the Interrupt Enable Set register (INTENSET).

**Name:** INTENCLR  
**Offset:** 0x00 [ID-00001eee]  
**Reset:** 0x00000000  
**Property:** PAC Write-Protection

Bit	31	30	29	28	27	26	25	24
Access								
Reset								
Bit	23	22	21	20	19	18	17	16
Access								
Reset								
Bit	15	14	13	12	11	10	9	8
					DPLLLDRTO	DPLLLTO	DPLLLCKF	DPLLLCKR
Access					R/W	R/W	R/W	R/W
Reset					0	0	0	0
Bit	7	6	5	4	3	2	1	0
				OSC48MRDY			CLKFAIL	XOSCRDY
Access				R/W			R/W	R/W
Reset				0			0	0

**Bit 11 – DPLLLDRTO: DPLL Loop Divider Ratio Update Complete Interrupt Enable**

Writing '0' to this bit has no effect.

Writing '1' to this bit will clear the DPLL Loop Divider Ratio Update Complete Interrupt Enable bit, which disables the DPLL Loop Divider Ratio Update Complete interrupt.

Value	Description
0	The DPLL Loop Divider Ratio Update Complete interrupt is disabled.
1	The DPLL Loop Divider Ratio Update Complete interrupt is enabled, and an interrupt request will be generated when the DPLL Loop Divider Ratio Update Complete Interrupt flag is set.

**Bit 10 – DPLLLTO: DPLL Lock Timeout Interrupt Enable**

Writing '0' to this bit has no effect.

Writing '1' to this bit will clear the DPLL Lock Timeout Interrupt Enable bit, which disables the DPLL Lock Timeout interrupt.

Value	Description
0	The DPLL Lock Timeout interrupt is disabled.
1	The DPLL Lock Timeout interrupt is enabled, and an interrupt request will be generated when the DPLL Lock Timeout Interrupt flag is set.

**Bit 9 – DPLLLCKF: DPLL Lock Fall Interrupt Enable**

Writing '0' to this bit has no effect.

Writing '1' to this bit will clear the DPLL Lock Fall Interrupt Enable bit, which disables the DPLL Lock Fall interrupt.

Value	Description
0	The DPLL Lock Fall interrupt is disabled.
1	The DPLL Lock Fall interrupt is enabled, and an interrupt request will be generated when the DPLL Lock Fall Interrupt flag is set.

## Bit 8 – DPLLLCKR: DPLL Lock Rise Interrupt Enable

Writing '0' to this bit has no effect.

Writing '1' to this bit will clear the DPLL Lock Rise Interrupt Enable bit, which disables the DPLL Lock Rise interrupt.

Value	Description
0	The DPLL Lock Rise interrupt is disabled.
1	The DPLL Lock Rise interrupt is enabled, and an interrupt request will be generated when the DPLL Lock Rise Interrupt flag is set.

## Bit 4 – OSC48MRDY: OSC48M Ready Interrupt Enable

Writing '0' to this bit has no effect.

Writing '1' to this bit will clear the OSC48M Ready Interrupt Enable bit, which disables the OSC48M Ready interrupt.

Value	Description
0	The OSC48M Ready interrupt is disabled.
1	The OSC48M Ready interrupt is enabled, and an interrupt request will be generated when the OSC48M Ready Interrupt flag is set.

## Bit 1 – CLKFAIL: Clock Failure Interrupt Enable

Writing '0' to this bit has no effect.

Writing '1' to this bit will clear the XOSC Clock Failure Interrupt Enable bit, which disables the XOSC Clock Failure interrupt.

Value	Description
0	The XOSC Clock Failure interrupt is disabled.
1	The XOSC Clock Failure interrupt is enabled, and an interrupt request will be generated when the XOSC Clock Failure Interrupt flag is set.

## Bit 0 – XOSCRDY: XOSC Ready Interrupt Enable

Writing '0' to this bit has no effect.

Writing '1' to this bit will clear the XOSC Ready Interrupt Enable bit, which disables the XOSC Ready interrupt.

Value	Description
0	The XOSC Ready interrupt is disabled.
1	The XOSC Ready interrupt is enabled, and an interrupt request will be generated when the XOSC Ready Interrupt flag is set.

### 21.8.2 Interrupt Enable Set

This register allows the user to disable an interrupt without doing a read-modify-write operation. Changes in this register will also be reflected in the Interrupt Enable Clear register (INTENCLR).

**Name:** INTENSET  
**Offset:** 0x04 [ID-00001eee]  
**Reset:** 0x00000000  
**Property:** PAC Write-Protection



Bit	31	30	29	28	27	26	25	24
Access								
Reset								
Bit	23	22	21	20	19	18	17	16
Access								
Reset								
Bit	15	14	13	12	11	10	9	8
					DPLLLDRTO	DPLLLTO	DPLLLCKF	DPLLLCKR
Access					R/W	R/W	R/W	R/W
Reset					0	0	0	0
Bit	7	6	5	4	3	2	1	0
				OSC48MRDY			CLKFAIL	XOSCRDY
Access				R/W			R/W	R/W
Reset				0			0	0

**Bit 11 – DPLLLDRTO: DPLL Loop Divider Ratio Update Complete Interrupt Enable**

Writing '0' to this bit has no effect.

Writing '1' to this bit will set the DPLL Loop Ratio Update Complete Interrupt Enable bit, which enables the DPLL Loop Ratio Update Complete interrupt.

Value	Description
0	The DPLL Loop Divider Ratio Update Complete interrupt is disabled.
1	The DPLL Loop Ratio Update Complete interrupt is enabled, and an interrupt request will be generated when the DPLL Loop Ratio Update Complete Interrupt flag is set.

**Bit 10 – DPLLLTO: DPLL Lock Timeout Interrupt Enable**

Writing '0' to this bit has no effect.

Writing '1' to this bit will set the DPLL Lock Timeout Interrupt Enable bit, which enables the DPLL Lock Timeout interrupt.

Value	Description
0	The DPLL Lock Timeout interrupt is disabled.
1	The DPLL Lock Timeout interrupt is enabled, and an interrupt request will be generated when the DPLL Lock Timeout Interrupt flag is set.

**Bit 9 – DPLLLCKF: DPLL Lock Fall Interrupt Enable**

Writing '0' to this bit has no effect.

Writing '1' to this bit will set the DPLL Lock Fall Interrupt Enable bit, which enables the DPLL Lock Fall interrupt.

Value	Description
0	The DPLL Lock Fall interrupt is disabled.
1	The DPLL Lock Fall interrupt is enabled, and an interrupt request will be generated when the DPLL Lock Fall Interrupt flag is set.

## Bit 8 – DPLLLCKR: DPLL Lock Rise Interrupt Enable

Writing '0' to this bit has no effect.

Writing '1' to this bit will set the DPLL Lock Rise Interrupt Enable bit, which enables the DPLL Lock Rise interrupt.

Value	Description
0	The DPLL Lock Rise interrupt is disabled.
1	The DPLL Lock Rise interrupt is enabled, and an interrupt request will be generated when the DPLL Lock Rise Interrupt flag is set.

## Bit 4 – OSC48MRDY: OSC48M Ready Interrupt Enable

Writing '0' to this bit has no effect.

Writing '1' to this bit will set the OSC48M Ready Interrupt Enable bit, which enables the OSC48M Ready interrupt.

Value	Description
0	The OSC48M Ready interrupt is disabled.
1	The OSC48M Ready interrupt is enabled, and an interrupt request will be generated when the OSC48M Ready Interrupt flag is set.

## Bit 1 – CLKFAIL: XOSC Clock Failure Interrupt Enable

Writing '0' to this bit has no effect.

Writing '1' to this bit will set the XOSC Clock Failure Interrupt Enable bit, which enables the XOSC Clock Failure Interrupt.

Value	Description
0	The XOSC Clock Failure Interrupt is disabled.
1	The XOSC Clock Failure Interrupt is enabled, and an interrupt request will be generated when the XOSC Clock Failure Interrupt flag is set.

## Bit 0 – XOSCRDY: XOSC Ready Interrupt Enable

Writing '0' to this bit has no effect.

Writing '1' to this bit will set the XOSC Ready Interrupt Enable bit, which enables the XOSC Ready interrupt.

Value	Description
0	The XOSC Ready interrupt is disabled.
1	The XOSC Ready interrupt is enabled, and an interrupt request will be generated when the XOSC Ready Interrupt flag is set.

### 21.8.3 Interrupt Flag Status and Clear

**Name:** INTFLAG  
**Offset:** 0x08 [ID-00001eee]  
**Reset:** 0x00000000  
**Property:** -

Bit	31	30	29	28	27	26	25	24
Access								
Reset								
Bit	23	22	21	20	19	18	17	16
Access								
Reset								
Bit	15	14	13	12	11	10	9	8
					DPLLLDRTO	DPLLLTO	DPLLLCKF	DPLLLCKR
Access					R/W	R/W	R/W	R/W
Reset					0	0	0	0
Bit	7	6	5	4	3	2	1	0
				OSC48MRDY			CLKFAIL	XOSCRDY
Access				R/W			R/W	R/W
Reset				0			0	0

**Bit 11 – DPLLLDRTO: DPLL Loop Divider Ratio Update Complete**

This flag is cleared by writing '1' to it.

This flag is set on 0-to-1 transition of the DPLL Loop Divider Ratio Update Complete bit in the Status register (STATUS.DPLLLDRTO) and will generate an interrupt request if INTENSET.DPLLLDRTO is '1'.

Writing '0' to this bit has no effect.

Writing '1' to this bit clears the DPLL Loop Divider Ratio Update Complete interrupt flag.

**Bit 10 – DPLLLTO: DPLL Lock Timeout**

This flag is cleared by writing '1' to it.

This flag is set on 0-to-1 transition of the DPLL Lock Timeout bit in the Status register (STATUS.DPLLLTO) and will generate an interrupt request if INTENSET.DPLLLTO is '1'.

Writing '0' to this bit has no effect.

Writing '1' to this bit clears the DPLL Lock Timeout interrupt flag.

**Bit 9 – DPLLLCKF: DPLL Lock Fall**

This flag is cleared by writing '1' to it.

This flag is set on 0-to-1 transition of the DPLL Lock Fall bit in the Status register (STATUS.DPLLLCKF) and will generate an interrupt request if INTENSET.DPLLLCKF is '1'.

Writing '0' to this bit has no effect.

Writing '1' to this bit clears the DPLL Lock Fall interrupt flag.

**Bit 8 – DPLLLCKR: DPLL Lock Rise**

This flag is cleared by writing '1' to it.

This flag is set on 0-to-1 transition of the DPLL Lock Rise bit in the Status register (STATUS.DPLLLCKR) and will generate an interrupt request if INTENSET.DPLLLCKR is '1'.

Writing '0' to this bit has no effect.

Writing '1' to this bit clears the DPLL Lock Rise interrupt flag.

#### **Bit 4 – OSC48MRDY: OSC48M Ready**

This flag is cleared by writing '1' to it.

This flag is set on 0-to-1 transition of the OSC48M Ready bit in the Status register (STATUS.OSC48MRDY) and will generate an interrupt request if INTENSET.OSC48MRDY is '1'.

Writing '0' to this bit has no effect.

Writing '1' to this bit clears the OSC48M Ready interrupt flag.

#### **Bit 1 – CLKFAIL: XOSC Failure Detection**

This flag is cleared by writing '1' to it.

This flag is set on a 0-to-1 transition of the XOSC Clock Failure bit in the Status register (STATUS.CLKFAIL) and will generate an interrupt request if INTENSET.CLKFAIL is '1'.

Writing '0' to this bit has no effect.

Writing '1' to this bit clears the XOSC Clock Fail interrupt flag.

#### **Bit 0 – XOSCRDY: XOSC Ready**

This flag is cleared by writing '1' to it.

This flag is set on a 0-to-1 transition of the XOSC Ready bit in the Status register (STATUS.XOSCRDY) and will generate an interrupt request if INTENSET.XOSCRDY is '1'.

Writing '0' to this bit has no effect.

Writing '1' to this bit clears the XOSC Ready interrupt flag.

#### **21.8.4 Status**

**Name:** STATUS

**Offset:** 0x0C [ID-00001eee]

**Reset:** 0x00000000

**Property:** -

Bit	31	30	29	28	27	26	25	24
Access								
Reset								
Bit	23	22	21	20	19	18	17	16
Access								
Reset								
Bit	15	14	13	12	11	10	9	8
					DPLLLDRTO	DPLLLTO	DPLLLCKF	DPLLLCKR
Access					R	R	R	R
Reset					0	0	0	0
Bit	7	6	5	4	3	2	1	0
				OSC48MRDY		CLKSW	CLKFAIL	XOSCRDY
Access				R		R	R	R
Reset				0		0	0	0

### Bit 11 – DPLLLDRTO: DPLL Loop Divider Ratio Update Complete

Value	Description
0	DPLL Loop Divider Ratio Update Complete not detected.
1	DPLL Loop Divider Ratio Update Complete detected.

### Bit 10 – DPLLLTO: DPLL Lock Timeout

Value	Description
0	DPLL Lock time-out not detected.
1	DPLL Lock time-out detected.

### Bit 9 – DPLLLCKF: DPLL Lock Fall

Value	Description
0	DPLL Lock fall edge not detected.
1	DPLL Lock fall edge detected.

### Bit 8 – DPLLLCKR: DPLL Lock Rise

Value	Description
0	DPLL Lock rise edge not detected.
1	DPLL Lock fall edge detected.

### Bit 4 – OSC48MRDY: OSC48M Ready

Value	Description
0	OSC48M is not ready.
1	OSC48M is stable and ready to be used as a clock source.

### Bit 2 – CLKSW: XOSC Clock Switch

Value	Description
0	XOSC is not switched and provides the external clock or crystal oscillator clock.
1	XOSC is switched and provides the safe clock.

### Bit 1 – CLKFAIL: XOSC Clock Failure

Value	Description
0	No XOSC failure detected.
1	A XOSC failure was detected.

### Bit 0 – XOSCRDY: XOSC Ready

Value	Description
0	XOSC is not ready.
1	XOSC is stable and ready to be used as a clock source.

## 21.8.5 External Multipurpose Crystal Oscillator (XOSC) Control

**Name:** XOSCCTRL  
**Offset:** 0x10 [ID-00001eee]  
**Reset:** 0x0080  
**Property:** PAC Write-Protection

Bit	15	14	13	12	11	10	9	8
	STARTUP[3:0]				AMPGC		GAIN[2:0]	
Access	R/W	R/W	R/W	R/W	R/W	R/W	R/W	R/W
Reset	0	0	0	0	0	0	0	0
Bit	7	6	5	4	3	2	1	0
	ONDEMAND	RUNSTDBY		SWBACK	CFDEN	XTALEN	ENABLE	
Access	R/W	R/W		R/W	R/W	R/W	R/W	
Reset	1	0		0	0	0	0	

### Bits 15:12 – STARTUP[3:0]: Start-Up Time

These bits select start-up time for the oscillator.

The OSCULP32K oscillator is used to clock the start-up counter.

**Table 21-5. Start-Up Time for External Multipurpose Crystal Oscillator**

STARTUP[3:0]	Number of OSCULP32K Clock Cycles	Number of XOSC Clock Cycles	Approximate Equivalent Time [μs]
0x0	1	3	31
0x1	2	3	61
0x2	4	3	122
0x3	8	3	244
0x4	16	3	488
0x5	32	3	977

STARTUP[3:0]	Number of OSCULP32K Clock Cycles	Number of XOSC Clock Cycles	Approximate Equivalent Time [ $\mu$ s]
0x6	64	3	1953
0x7	128	3	3906
0x8	256	3	7813
0x9	512	3	15625
0xA	1024	3	31250
0xB	2048	3	62500 $\mu$ s
0xC	4096	3	125000
0xD	8192	3	250000
0xE	16384	3	500000
0xF	32768	3	1000000

**Note:**

1. Actual startup time is 1 OSCULP32K cycle + 3 XOSC cycles.
2. The given time neglects the three XOSC cycles before OSCULP32K cycle.

**Bit 11 – AMPGC: Automatic Amplitude Gain Control**

**Note:** This bit must be set only after the XOSC has settled, indicated by the XOSC Ready flag in the Status register (STATUS.XOSCRDY).

Value	Description
0	The automatic amplitude gain control is disabled.
1	The automatic amplitude gain control is enabled. Amplitude gain will be automatically adjusted during Crystal Oscillator operation.

**Bits 10:8 – GAIN[2:0]: Oscillator Gain**

These bits select the gain for the oscillator. The listed maximum frequencies are recommendations, and might vary based on capacitive load and crystal characteristics. Those bits must be properly configured even when the Automatic Amplitude Gain Control is active.

Value	Recommended Max Frequency [MHz]
0x0	2
0x1	4
0x2	8
0x3	16
0x4	30
0x5-0x7	Reserved

**Bit 7 – ONDEMAND: On Demand Control**

The On Demand operation mode allows the oscillator to be enabled or disabled, depending on peripheral clock requests.

If the ONDEMAND bit has been previously written to '1', the oscillator will be running only when requested by a peripheral. If there is no peripheral requesting the oscillator's clock source, the oscillator will be in a disabled state.

If On Demand is disabled, the oscillator will always be running when enabled.

In standby sleep mode, the On Demand operation is still active.

Value	Description
0	The oscillator is always on, if enabled.
1	The oscillator is enabled when a peripheral is requesting the oscillator to be used as a clock source. The oscillator is disabled if no peripheral is requesting the clock source.

### Bit 6 – RUNSTDBY: Run in Standby

This bit controls how the XOSC behaves during standby sleep mode, together with the ONDEMAND bit:

Value	Description
0	The XOSC is not running in Standby sleep mode if no peripheral requests the clock.
1	The XOSC is running in Standby sleep mode. If ONDEMAND=1, the XOSC will be running when a peripheral is requesting the clock. If ONDEMAND=0, the clock source will always be running in Standby sleep mode.

### Bit 4 – SWBACK: Clock Switch Back

This bit controls the XOSC output switch back to the external clock or crystal oscillator in case of clock recovery:

Value	Description
0	The clock switch back is disabled.
1	The clock switch back is enabled. This bit is reset once the XOSC putput clock is switched back to the external clock or crystal oscillator.

### Bit 3 – CFDEN: Clock Failure Detector Enable

This bit controls the clock failure detector:

Value	Description
0	The Clock Failure Detector is disabled.
1	the Clock Failure Detector is enabled.

### Bit 2 – XTALEN: Crystal Oscillator Enable

This bit controls the connections between the I/O pads and the external clock or crystal oscillator:

Value	Description
0	External clock connected on XIN. XOUT can be used as general-purpose I/O.
1	Crystal connected to XIN/XOUT.

### Bit 1 – ENABLE: Oscillator Enable

Value	Description
0	The oscillator is disabled.
1	The oscillator is enabled.

## 21.8.6 Clock Failure Detector Prescaler



**Name:** CFDPRESC  
**Offset:** 0x12  
**Reset:** 0x00  
**Property:** PAC Write-Protection



**Bits 2:0 – CFDPRESC[2:0]: Clock Failure Detector Prescaler**

These bits select the prescaler for the clock failure detector.

The OSC48M oscillator is used to clock the CFD prescaler. The CFD safe clock frequency is the OSC48M frequency divided by  $2^{CFDPRESC}$ .

### 21.8.7 Event Control

**Name:** EVCTRL  
**Offset:** 0x13  
**Reset:** 0x00  
**Property:** PAC Write-Protection

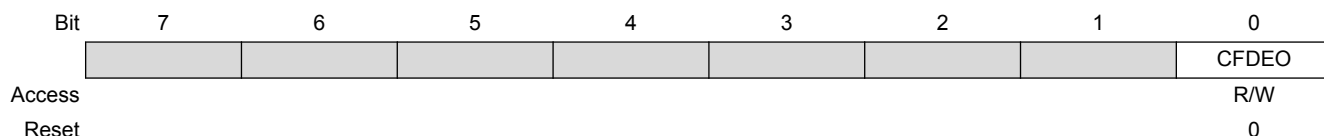

**Bit 0 – CFDEO: Clock Failure Detector Event Output Enable**

This bit indicates whether the Clock Failure detector event output is enabled or not and an output event will be generated when the Clock Failure detector detects a clock failure

Value	Description
0	Clock Failure detector event output is disabled and no event will be generated.
1	Clock Failure detector event output is enabled and an event will be generated.

### 21.8.8 48MHz Internal Oscillator (OSC48M) Control

**Name:** OSC48MCTRL  
**Offset:** 0x14 [ID-00001eee]  
**Reset:** 0x82  
**Property:** PAC Write-Protection

Bit	7	6	5	4	3	2	1	0
	ONDEMAND	RUNSTDBY					ENABLE	
Access	R/W	R/W					R/W	
Reset	1	0					1	

### Bit 7 – ONDEMAND: On Demand Control

The On Demand operation mode allows the oscillator to be enabled or disabled depending on peripheral clock requests.

If the ONDEMAND bit has been previously written to '1', the oscillator will only be running when requested by a peripheral. If there is no peripheral requesting the oscillator's clock source, the oscillator will be in a disabled state.

If On Demand is disabled the oscillator will always be running when enabled.

In standby sleep mode, the On Demand operation is still active.

Value	Description
0	The oscillator is always on, if enabled.
1	The oscillator is enabled when a peripheral is requesting the oscillator to be used as a clock source. The oscillator is disabled if no peripheral is requesting the clock source.

### Bit 6 – RUNSTDBY: Run in Standby

This bit controls how the OSC48M behaves during standby sleep mode.

Value	Description
0	The OSC48M is disabled in standby sleep mode if no peripheral requests the clock.
1	The OSC48M is not stopped in standby sleep mode. If ONDEMAND=1, the OSC48M will be running when a peripheral is requesting the clock. If ONDEMAND=0, the clock source will always be running in standby sleep mode.

### Bit 1 – ENABLE: Oscillator Enable

Value	Description
0	The oscillator is disabled.
1	The oscillator is enabled.

## 21.8.9 OSC48M Divider

**Name:** OSC48MDIV  
**Offset:** 0x15 [ID-00001eee]  
**Reset:** 0x0B  
**Property:** -

Bit	7	6	5	4	3	2	1	0
					DIV[3:0]			
Access					R/W	R/W	R/W	R/W
Reset					1	0	1	1

### Bits 3:0 – DIV[3:0]: Oscillator Divider Selection

These bits control the oscillator frequency range by adjusting the division ratio. The oscillator frequency is 48MHz divided by DIV+1.

Value	Description
0000	48MHz
0001	24MHz
0010	16MHz
0011	12MHz
0100	9.6MHz
0101	8MHz
0110	6.86MHz
0111	6MHz
1000	5.33MHz
1001	4.8MHz
1010	4.36MHz
1011	4MHz
1100	3.69MHz
1101	3.43MHz
1110	3.2MHz
1111	3MHz

## 21.8.10 OSC48M Startup

**Name:** OSC48MSTUP  
**Offset:** 0x16 [ID-00001eee]  
**Reset:** 0x07  
**Property:** -

Bit	7	6	5	4	3	2	1	0
						STARTUP[2:0]		
Access						R/W	R/W	R/W
Reset						1	1	1

### Bits 2:0 – STARTUP[2:0]: Oscillator Startup Delay

These bits select the oscillator start-up delay in oscillator cycles.

**Table 21-6. Oscillator Divider Selection**

STARTUP[2:0]	Number of OSCM48M Clock Cycles	Approximate Equivalent Time
0x0	8	166ns
0x1	16	333ns
0x2	32	667ns
0x3	64	1.333µs
0x4	128	2.667µs
0x5	256	5.333µs
0x6	512	10.667µs
0x7	1024	21.333µs

## 21.8.11 OSC48M Synchronization Busy

**Name:** OSC48MSYNCBUSY

**Offset:** 0x18 [ID-00001eee]

**Reset:** 0x00000000

**Property:** -



### Bit 2 – OSC48MDIV: Oscillator Divider Synchronization Status

This bit is set when OSC48MDIV register is written.

This bit is cleared when OSC48MDIV synchronization is completed.

Value	Description
0	No synchronized access.
1	Synchronized access is ongoing.

## 21.8.12 DPLL Control A

**Name:** DPLLCTRLA

**Offset:** 0x1C [ID-00001eee]

**Reset:** 0x80

**Property:** PAC Write-Protection, Write-Synchronized (ENABLE)

Bit	7	6	5	4	3	2	1	0
	ONDEMAND	RUNSTDBY					ENABLE	
Access	R/W	R/W					R/W	
Reset	1	0					0	

### Bit 7 – ONDEMAND: On Demand Clock Activation

The On Demand operation mode allows the DPLL to be enabled or disabled depending on peripheral clock requests.

If the ONDEMAND bit has been previously written to '1', the DPLL will only be running when requested by a peripheral. If there is no peripheral requesting the DPLL's clock source, the DPLL will be in a disabled state.

If On Demand is disabled the DPLL will always be running when enabled.

In standby sleep mode, the On Demand operation is still active.

Value	Description
0	The DPLL is always on, if enabled.
1	The DPLL is enabled when a peripheral is requesting the DPLL to be used as a clock source. The DPLL is disabled if no peripheral is requesting the clock source.

### Bit 6 – RUNSTDBY: Run in Standby

This bit controls how the DPLL behaves during standby sleep mode:

Value	Description
0	The DPLL is disabled in standby sleep mode if no peripheral requests the clock.
1	The DPLL is not stopped in standby sleep mode. If ONDEMAND=1, the DPLL will be running when a peripheral is requesting the clock. If ONDEMAND=0, the clock source will always be running in standby sleep mode.

### Bit 1 – ENABLE: DPLL Enable

The software operation of enabling or disabling the DPLL takes a few clock cycles, so the DPLLSYNCBUSY.ENABLE status bit indicates when the DPLL is successfully enabled or disabled.

Value	Description
0	The DPLL is disabled.
1	The DPLL is enabled.

## 21.8.13 DPLL Ratio Control

**Name:** DPLL\_RATIO

**Offset:** 0x20 [ID-00001eee]

**Reset:** 0x00

**Property:** PAC Write-Protection, Write-Synchronized

Bit	31	30	29	28	27	26	25	24
Access								
Reset								
Bit	23	22	21	20	19	18	17	16
					LDRFRAC[3:0]			
Access					R/W	R/W	R/W	R/W
Reset					0	0	0	0
Bit	15	14	13	12	11	10	9	8
					LDR[11:8]			
Access					R/W	R/W	R/W	R/W
Reset					0	0	0	0
Bit	7	6	5	4	3	2	1	0
	LDR[7:0]							
Access	R/W	R/W	R/W	R/W	R/W	R/W	R/W	R/W
Reset	0	0	0	0	0	0	0	0

**Bits 19:16 – LDRFRAC[3:0]: Loop Divider Ratio Fractional Part**

Writing these bits selects the fractional part of the frequency multiplier. Due to synchronization there is a delay between writing these bits and the effect on the DPLL output clock. The value written will read back immediately and the DPLL RATIO bit in the DPLL Synchronization Busy register (DPLLSYNCBUSY.DPLL RATIO) will be set. DPLLSYNCBUSY.DPLL RATIO will be cleared when the operation is completed.

**Bits 11:0 – LDR[11:0]: Loop Divider Ratio**

Writing these bits selects the integer part of the frequency multiplier. The value written to these bits will read back immediately, and the DPLL RATIO bit in the DPLL Synchronization busy register (DPLLSYNCBUSY.DPLL RATIO), will be set. DPLLSYNCBUSY.DPLL RATIO will be cleared when the operation is completed.

**21.8.14 DPLL Control B**

**Name:** DPLLCTRLB  
**Offset:** 0x24 [ID-00001eee]  
**Reset:** 0x00  
**Property:** Enable-Protected, PAC Write-Protection

Bit	31	30	29	28	27	26	25	24
	DIV[10:8]							
Access						R/W	R/W	R/W
Reset						0	0	0
Bit	23	22	21	20	19	18	17	16
	DIV[7:0]							
Access	R/W	R/W	R/W	R/W	R/W	R/W	R/W	R/W
Reset	0	0	0	0	0	0	0	0
Bit	15	14	13	12	11	10	9	8
	LBYPASS			LTIME[2:0]				
Access				R/W		R/W	R/W	R/W
Reset				0		0	0	0
Bit	7	6	5	4	3	2	1	0
	REFCLK[1:0]		WUF		LPEN		FILTER[1:0]	
Access			R/W	R/W	R/W	R/W	R/W	R/W
Reset			0	0	0	0	0	0

### Bits 26:16 – DIV[10:0]: Clock Divider

These bits set the XOSC clock division factor and can be calculated with following formula:

$$f_{DIV} = \frac{f_{XOSC}}{2x(DIV + 1)}$$

### Bit 12 – LBYPASS: Lock Bypass

Value	Description
0	DPLL Lock signal drives the DPLL controller internal logic.
1	DPLL Lock signal is always asserted.

### Bits 10:8 – LTIME[2:0]: Lock Time

These bits select the lock time-out value:

Value	Name	Description
0x0	Default	No time-out. Automatic lock.
0x1	Reserved	
0x2	Reserved	
0x3	Reserved	
0x4	8MS	Time-out if no lock within 8ms
0x5	9MS	Time-out if no lock within 9ms
0x6	10MS	Time-out if no lock within 10ms
0x7	11MS	Time-out if no lock within 11ms

### Bits 5:4 – REFCLK[1:0]: Reference Clock Selection

Write these bits to select the DPLL clock reference:

Value	Name	Description
0x0	XOSC32K	XOSC32K clock reference
0x1	XOSC	XOSC clock reference

Value	Name	Description
0x2	GCLK	GCLK clock reference
0x3	Reserved	

### Bit 3 – WUF: Wake Up Fast

Value	Description
0	DPLL clock is output after startup and lock time.
1	DPLL clock is output after startup time.

### Bit 2 – LPEN: Low-Power Enable

Value	Description
0	The low-power mode is disabled. Time to Digital Converter is enabled.
1	The low-power mode is enabled. Time to Digital Converter is disabled. This will improve power consumption but increase the output jitter.

### Bits 1:0 – FILTER[1:0]: Proportional Integral Filter Selection

These bits select the DPLL filter type:

Value	Name	Description
0x0	DEFAULT	Default filter mode
0x1	LBFILT	Low bandwidth filter
0x2	HBFILT	High bandwidth filter
0x3	HDFILT	High damping filter

## 21.8.15 DPLL Prescaler

**Name:** DPLLPRESC

**Offset:** 0x28 [ID-00001eee]

**Reset:** 0x00

**Property:** PAC Write-Protection, Write-Synchronized

Bit	7	6	5	4	3	2	1	0
							PRESC[1:0]	
Access							R/W	R/W
Reset							0	0

### Bits 1:0 – PRESC[1:0]: Output Clock Prescaler

These bits define the output clock prescaler setting.

Value	Name	Description
0x0	DIV1	DPLL output is divided by 1
0x1	DIV2	DPLL output is divided by 2
0x2	DIV4	DPLL output is divided by 4
0x3	Reserved	

## 21.8.16 DPLL Synchronization Busy



**Name:** DPLLSYNCBUSY  
**Offset:** 0x2C [ID-00001eee]  
**Reset:** 0x00  
**Property:** –

	Bit	7	6	5	4	3	2	1	0
						DPLLPRESC	DPLLRATIO	ENABLE	
Access						R	R	R	
Reset						0	0	0	

### Bit 3 – DPLLPRESC: DPLL Prescaler Synchronization Status

Value	Description
0	The DPLLPRESC register has been synchronized.
1	The DPLLPRESC register value has changed and its synchronization is in progress.

### Bit 2 – DPLLRATIO: DPLL Loop Divider Ratio Synchronization Status

Value	Description
0	The DPLLRATIO register has been synchronized.
1	The DPLLRATIO register value has changed and its synchronization is in progress.

### Bit 1 – ENABLE: DPLL Enable Synchronization Status

Value	Description
0	The DPLLCTRLA.ENABLE bit has been synchronized.
1	The DPLLCTRLA.ENABLE bit value has changed and its synchronization is in progress.

## 21.8.17 DPLL Status

**Name:** DPLLSTATUS  
**Offset:** 0x30 [ID-00001eee]  
**Reset:** 0x00  
**Property:** –

	Bit	7	6	5	4	3	2	1	0
								CLKRDY	LOCK
Access								R	R
Reset								0	0

### Bit 1 – CLKRDY: Output Clock Ready

Value	Description
0	The DPLL output clock is off.
1	The DPLL output clock is on.

### Bit 0 – LOCK: DPLL Lock status bit

Value	Description
0	The DPLL Lock signal is cleared, when the DPLL is disabled or when the DPLL is trying to reach the target frequency.
1	The DPLL Lock signal is asserted when the desired frequency is reached.

## 21.8.18 OSC48M Calibration

This register (bits 0 to 21) must be updated with the corresponding data in the NVM Software Calibration Area: CAL48M 5V or CAL48M 3V3, depending on the VDD range. Refer to [NVM Software Calibration Area Mapping](#).

**Note:** This register is only available for Rev D silicon.

**Name:** CAL48M

**Offset:** 0x38 [ID-00001eee]

**Reset:** Calibrated value for VDD range 3.6 V to 5.5 V

**Property:** PAC Write-Protection

Bit	31	30	29	28	27	26	25	24	
Access									
Reset									
Bit	23	22	21	20	19	18	17	16	
Access			TCAL[5:0]						
Reset			x	x	x	x	x	x	
Bit	15	14	13	12	11	10	9	8	
Access							FRANGE[1:0]		
Reset							x	x	
Bit	7	6	5	4	3	2	1	0	
Access			FCAL[5:0]						
Reset			x	x	x	x	x	x	

**Bits 21:16 – TCAL[5:0]: Temperature Calibration**

**Bits 9:8 – FRANGE[1:0]: Frequency Range**

**Bits 5:0 – FCAL[5:0]: Frequency Calibration**

## 22. OSC32KCTRL – 32KHz Oscillators Controller

### 22.1 Overview

The 32KHz Oscillators Controller (OSC32KCTRL) provides a user interface to the 32.768kHz oscillators: XOSC32K, OSC32K, and OSCULP32K.

The OSC32KCTRL sub-peripherals can be enabled, disabled, calibrated, and monitored through interface registers.

All sub-peripheral statuses are collected in the Status register (STATUS). They can additionally trigger interrupts upon status changes via the INTENSET, INTENCLR, and INTFLAG registers.

### 22.2 Features

- 32.768kHz Crystal Oscillator (XOSC32K)
  - Programmable start-up time
  - Crystal or external input clock on XIN32 I/O
  - Clock failure detection with safe clock switch
  - Clock failure event output
- 32.768kHz High Accuracy Internal Oscillator (OSC32K)
  - Frequency fine tuning
  - Programmable start-up time
- 32.768kHz Ultra Low Power Internal Oscillator (OSCULP32K)
  - Ultra low power, always-on oscillator
  - Frequency fine tuning
- Calibration value loaded from Flash factory calibration at reset
- 1.024kHz clock outputs available

22.3 Block Diagram

Figure 22-1. OSC32KCTRL Block Diagram



22.4 Signal Description

Signal	Description	Type
XIN32	Analog Input	32.768kHz Crystal Oscillator or external clock generator input
XOUT32	Analog Output	32.768kHz Crystal Oscillator output

The I/O lines are automatically selected when XOSC32K is enabled.

**Note:** The signal of the external crystal oscillator may affect the jitter of neighboring pads.

22.5 Product Dependencies

In order to use this peripheral, other parts of the system must be configured correctly, as described below.

22.5.1 I/O Lines

I/O lines are configured by OSC32KCTRL when XOSC32K is enabled, and need no user configuration.

22.5.2 Power Management

The OSC32KCTRL will continue to operate in any sleep mode where a 32KHz oscillator is running as source clock. The OSC32KCTRL interrupts can be used to wake up the device from sleep modes.

Related Links

[PM – Power Manager](#)

## 22.5.3 Clocks

The OSC32KCTRL gathers controls for all 32KHz oscillators and provides clock sources to the Generic Clock Controller (GCLK), Real-Time Counter (RTC), and Watchdog Timer (WDT).

The available clock sources are: XOSC32K, OSC32K, and OSCULP32K.

The OSC32KCTRL bus clock (CLK\_OSC32KCTRL\_APB) can be enabled and disabled in the Main Clock module (MCLK).

### Related Links

[Peripheral Clock Masking](#)

## 22.5.4 Interrupts

The interrupt request lines are connected to the interrupt controller. Using the OSC32KCTRL interrupts requires the interrupt controller to be configured first.

### Related Links

[Nested Vector Interrupt Controller](#)

## 22.5.5 Events

The events of this peripheral are connected to the Event System.

### Related Links

[EVSYS – Event System](#)

## 22.5.6 Debug Operation

When the CPU is halted in debug mode, OSC32KCTRL will continue normal operation. If OSC32KCTRL is configured in a way that requires it to be periodically serviced by the CPU through interrupts or similar, improper operation or data loss may result during debugging.

## 22.5.7 Register Access Protection

All registers with write-access can be write-protected optionally by the Peripheral Access Controller (PAC), except for the following registers:

- Interrupt Flag Status and Clear (INTFLAG) register

Optional write-protection by the Peripheral Access Controller (PAC) is denoted by the "PAC Write-Protection" property in each individual register description.

PAC write-protection does not apply to accesses through an external debugger.

### Related Links

[PAC - Peripheral Access Controller](#)

## 22.5.8 Analog Connections

The external 32.768kHz crystal must be connected between the XIN32 and XOUT32 pins, along with any required load capacitors. For details on recommended oscillator characteristics and capacitor load, refer to the related links.

### Related Links

[Electrical Characteristics 85°C \(SAM C20J/G/E\)](#)

## 22.5.9 Calibration

The OSC32K calibration value from the production test must be loaded from the NVM Software Calibration Area into the OSC32K register (OSC32K.CALIB) by software to achieve specified accuracy.

## Related Links

[NVM Software Calibration Area Mapping](#)

## 22.6 Functional Description

### 22.6.1 Principle of Operation

XOSC32K, OSC32K, and OSCULP32K are configured via OSC32KCTRL control registers. Through this interface, the sub-peripherals are enabled, disabled, or have their calibration values updated.

The STATUS register gathers different status signals coming from the sub-peripherals of OSC32KCTRL. The status signals can be used to generate system interrupts, and in some cases wake up the system from standby mode, provided the corresponding interrupt is enabled.

### 22.6.2 32KHz External Crystal Oscillator (XOSC32K) Operation

The XOSC32K can operate in two different modes:

- External clock, with an external clock signal connected to XIN32
- Crystal oscillator, with an external 32.768kHz crystal connected between XIN32 and XOUT32

At reset, the XOSC32K is disabled, and the XIN32/XOUT32 pins can either be used as General Purpose I/O (GPIO) pins or by other peripherals in the system.

When XOSC32K is enabled, the operating mode determines the GPIO usage. When in crystal oscillator mode, the XIN32 and XOUT32 pins are controlled by the OSC32KCTRL, and GPIO functions are overridden on both pins. When in external clock mode, the only XIN32 pin will be overridden and controlled by the OSC32KCTRL, while the XOUT32 pin can still be used as a GPIO pin.

The XOSC32K is enabled by writing a '1' to the Enable bit in the 32KHz External Crystal Oscillator Control register (XOSC32K.ENABLE=1). The XOSC32K is disabled by writing a '0' to the Enable bit in the 32KHz External Crystal Oscillator Control register (XOSC32K.ENABLE=0).

To enable the XOSC32K as a crystal oscillator, the XTALEN bit in the 32KHz External Crystal Oscillator Control register must be set (XOSC32K.XTALEN=1). If XOSC32K.XTALEN is '0', the external clock input will be enabled.

The XOSC32K 32.768kHz output is enabled by setting the 32KHz Output Enable bit in the 32KHz External Crystal Oscillator Control register (XOSC32K.EN32K=1). The XOSC32K also has a 1.024kHz clock output. This is enabled by setting the 1KHz Output Enable bit in the 32KHz External Crystal Oscillator Control register (XOSC32K.EN1K=1).

It is also possible to lock the XOSC32K configuration by setting the Write Lock bit in the 32KHz External Crystal Oscillator Control register (XOSC32K.WRTLOCK=1). If set, the XOSC32K configuration is locked until a Power-On Reset (POR) is detected.

The XOSC32K will behave differently in different sleep modes based on the settings of XOSC32K.RUNSTDBY, XOSC32K.ONDEMAND, and XOSC32K.ENABLE. If XOSC32KCTRL.ENABLE=0, the XOSC32K will be always stopped. For XOSC32KCTRL.ENABLE=1, this table is valid:

**Table 22-1. XOSC32K Sleep Behavior**

CPU Mode	XOSC32K. RUNSTDBY	XOSC32K. ONDEMAND	Sleep Behavior of XOSC32K and CFD
Active or Idle	-	0	Always run
Active or Idle	-	1	Run if requested by peripheral
Standby	1	0	Always run
Standby	1	1	Run if requested by peripheral
Standby	0	-	Run if requested by peripheral

As a crystal oscillator usually requires a very long start-up time, the 32KHz External Crystal Oscillator will keep running across resets when XOSC32K.ONDEMAND=0, except for power-on reset (POR). After a reset or when waking up from a sleep mode where the XOSC32K was disabled, the XOSC32K will need a certain amount of time to stabilize on the correct frequency. This start-up time can be configured by changing the Oscillator Start-Up Time bit group (XOSC32K.STARTUP) in the 32KHz External Crystal Oscillator Control register. During the start-up time, the oscillator output is masked to ensure that no unstable clock propagates to the digital logic.

Once the external clock or crystal oscillator is stable and ready to be used as a clock source, the XOSC32K Ready bit in the Status register is set (STATUS.XOSC32KRDY=1). The transition of STATUS.XOSC32KRDY from '0' to '1' generates an interrupt if the XOSC32K Ready bit in the Interrupt Enable Set register is set (INTENSET.XOSC32KRDY=1).

The XOSC32K can be used as a source for Generic Clock Generators (GCLK) or for the Real-Time Counter (RTC). Before enabling the GCLK or the RTC module, the corresponding oscillator output must be enabled (XOSC32K.EN32K or XOSC32K.EN1K) in order to ensure proper operation. In the same way, the GCLK or RTC modules must be disabled before the clock selection is changed. For details on RTC clock configuration, refer also to [Real-Time Counter Clock Selection](#).

**Related Links**

[GCLK - Generic Clock Controller](#)

[RTC – Real-Time Counter](#)

**22.6.3 Clock Failure Detection Operation**

The Clock Failure Detector (CFD) allows the user to monitor the external clock or crystal oscillator signal provided by the external oscillator (XOSC32K). The CFD detects failing operation of the XOSC32K clock with reduced latency, and allows to switch to a safe clock source in case of clock failure. The user can also switch from the safe clock back to XOSC32K in case of recovery. The safe clock is derived from the OSCULP32K oscillator with a configurable prescaler. This allows to configure the safe clock in order to fulfill the operative conditions of the microcontroller.

In sleep modes, CFD operation is automatically disabled when the external oscillator is not requested to run by a peripheral. See the Sleep Behavior table above when this is the case.

The user interface registers allow to enable, disable, and configure the CFD. The Status register provides status flags on failure and clock switch conditions. The CFD can optionally trigger an interrupt or an event when a failure is detected.

## Clock Failure Detection

The CFD is reset only at power-on (POR). The CFD does not monitor the XOSC32K clock when the oscillator is disabled (XOSC32K.ENABLE=0).

Before starting CFD operation, the user must start and enable the safe clock source (OSCULP32K oscillator).

CFD operation is started by writing a '1' to the CFD Enable bit in the External Oscillator Control register (CFDCTRL.CFDEN). After starting or restarting the XOSC32K, the CFD does not detect failure until the start-up time has elapsed. The start-up time is configured by the Oscillator Start-Up Time in the External Multipurpose Crystal Oscillator Control register (XOSC32K.STARTUP). Once the XOSC32K Start-Up Time is elapsed, the XOSC32K clock is constantly monitored.

During a period of 4 safe clocks (monitor period), the CFD watches for a clock activity from the XOSC32K. There must be at least one rising and one falling XOSC32K clock edge during 4 safe clock periods to meet non-failure conditions. If no or insufficient activity is detected, the failure status is asserted: The Clock Failure Detector status bit in the Status register (STATUS.CLKFAIL) and the Clock Failure Detector interrupt flag bit in the Interrupt Flag register (INTFLAG.CLKFAIL) are set. If the CLKFAIL bit in the Interrupt Enable Set register (INTENSET.CLKFAIL) is set, an interrupt is generated as well. If the Event Output enable bit in the Event Control register (EVCTRL.CFDEO) is set, an output event is generated, too.

After a clock failure was issued the monitoring of the XOSC32K clock is continued, and the Clock Failure Detector status bit in the Status register (STATUS.CLKFAIL) reflects the current XOSC32K activity.

## Clock Switch

When a clock failure is detected, the XOSC32K clock is replaced by the safe clock in order to maintain an active clock during the XOSC32K clock failure. The safe clock source is the OSCULP32K oscillator clock. Both 32KHz and 1KHz outputs of the XOSC32K are replaced by the respective OSCULP32K 32KHz and 1KHz outputs. The safe clock source can be scaled down by a configurable prescaler to ensure that the safe clock frequency does not exceed the operating conditions selected by the application. When the XOSC32K clock is switched to the safe clock, the Clock Switch bit in the Status register (STATUS.CLKSW) is set.

When the CFD has switched to the safe clock, the XOSC32K is not disabled. If desired, the application must take the necessary actions to disable the oscillator. The application must also take the necessary actions to configure the system clocks to continue normal operations. In the case the application can recover the XOSC32K, the application can switch back to the XOSC32K clock by writing a '1' to Switch Back Enable bit in the Clock Failure Control register (CFDCTRL.SWBACK). Once the XOSC32K clock is switched back, the Switch Back bit (CFDCTRL.SWBACK) is cleared by hardware.

## Prescaler

The CFD has an internal configurable prescaler to generate the safe clock from the OSCULP32K oscillator. The prescaler size allows to scale down the OSCULP32K oscillator so the safe clock frequency is not higher than the XOSC32K clock frequency monitored by the CFD. The maximum division factor is 2.

The prescaler is applied on both outputs (32KHz and 1KHz) of the safe clock.

### Example

For an external crystal oscillator at 32KHz and the OSCULP32K frequency is 32KHz, the XOSC32K.CFDPRESC should be set to 0 for a safe clock of equal frequency.



## Event

If the Event Output Enable bit in the Event Control register (EVCTRL.CFDEO) is set, the CFD clock failure will be output on the Event Output. When the CFD is switched to the safe clock, the CFD clock failure will not be output on the Event Output.

## Sleep Mode

The CFD is halted depending on configuration of the XOSC32K and the peripheral clock request. For further details, refer to the Sleep Behavior table above. The CFD interrupt can be used to wake up the device from sleep modes.

### 22.6.4 32KHz Internal Oscillator (OSC32K) Operation

The OSC32K provides a tunable, low-speed, and low-power clock source.

At reset, the OSC32K is disabled. It can be enabled by setting the Enable bit in the 32KHz Internal Oscillator Control register (OSC32K.ENABLE=1). The OSC32K is disabled by clearing the Enable bit in the 32KHz Internal Oscillator Control register (OSC32K.ENABLE=0).

The frequency of the OSC32K oscillator is controlled by OSC32K.CALIB, which is a calibration value in the 32KHz Internal Oscillator Calibration bits in the 32KHz Internal Oscillator Control register. The CALIB value must be loaded with production calibration values from the NVM Software Calibration Area. When writing the Calibration bits, the user must wait for the STATUS.OSC32KRDY bit to go high before the new value is committed to the oscillator.

The OSC32K has a 32.768kHz output which is enabled by setting the 32KHz Output Enable bit in the 32KHz Internal Oscillator Control register (OSC32K.EN32K=1). The OSC32K also has a 1.024kHz clock output. This is enabled by setting the 1KHz Output Enable bit in the 32KHz Internal Oscillator Control register (OSC32K.EN1K).

Before using the OSC32K, the Calibration field in the OSC32K register (OSC32K.CALIB) must be loaded with production calibration values from the NVM Software Calibration Area.

The OSC32K will behave differently in different sleep modes based on the settings of OSC32K.RUNSTDBY, OSC32K.ONDEMAND, and OSC32K.ENABLE. If OSC32KCTRL.ENABLE=0, the OSC32K will be always stopped. For OSC32KCTRL.ENABLE=1, this table is valid:

**Table 22-2. OSC32K Sleep Behavior**

CPU Mode	OSC32KCTRL.RUN STDBY	OSC32KCTRL.OND EMAND	Sleep Behavior
Active or Idle	-	0	Always run
Active or Idle	-	1	Run if requested by peripheral
Standby	1	0	Always run
Standby	1	1	Run if requested by peripheral
Standby	0	-	Run if requested by peripheral

The OSC32K requires a start-up time. For this reason, OSC32K will keep running across resets when OSC32K.ONDEMAND=0, except for power-on reset (POR).

After such a reset, or when waking up from a sleep mode where the OSC32K was disabled, the OSC32K will need a certain amount of time to stabilize on the correct frequency.

This startup time can be configured by changing the Oscillator Start-Up Time bit group (OSC32K.STARTUP) in the OSC32K Control register. During the start-up time, the oscillator output is masked to ensure that no unstable clock propagates to the digital logic.

Once the external clock or crystal oscillator is stable and ready to be used as a clock source, the OSC32K Ready bit in the Status register is set (STATUS.OSC32KRDY=1). The transition of STATUS.OSC32KRDY from '0' to '1' generates an interrupt if the OSC32K Ready bit in the Interrupt Enable Set register is set (INTENSET.OSC32KRDY=1).

The OSC32K can be used as a source for Generic Clock Generators (GCLK) or for the Real-Time Counter (RTC). Before enabling the GCLK or the RTC module, the corresponding oscillator output must be enabled (OSC32K.EN32K or OSC32K.EN1K) in order to ensure proper operation. In the same way, the GCLK or RTC modules must be disabled before the clock selection is changed.

#### Related Links

[NVM Software Calibration Area Mapping](#)

[RTC – Real-Time Counter](#)

[Real-Time Counter Clock Selection](#)

### 22.6.5 32KHz Ultra Low Power Internal Oscillator (OSCULP32K) Operation

The OSCULP32K provides a tunable, low-speed, and ultra-low-power clock source. The OSCULP32K is factory-calibrated under typical voltage and temperature conditions. The OSCULP32K should be preferred to the OSC32K whenever the power requirements are prevalent over frequency stability and accuracy.

The OSCULP32K is enabled by default after a power-on reset (POR) and will always run except during POR. The frequency of the OSCULP32K oscillator is controlled by the value in the 32KHz Ultra Low Power Internal Oscillator Calibration bits in the 32KHz Ultra Low Power Internal Oscillator Control register (OSCULP32K.CALIB). This data is used to compensate for process variations.

OSCULP32K.CALIB is automatically loaded from Flash Factory Calibration during start-up. The calibration value can be overridden by the user by writing to OSCULP32K.CALIB.

It is also possible to lock the OSCULP32K configuration by setting the Write Lock bit in the 32KHz Ultra Low Power Internal Oscillator Control register (OSCULP32K.WRTLOCK=1). If set, the OSCULP32K configuration is locked until a power-on reset (POR) is detected.

The OSCULP32K can be used as a source for Generic Clock Generators (GCLK) or for the Real-Time Counter (RTC). To ensure proper operation, the GCLK or RTC modules must be disabled before the clock selection is changed.

#### Related Links

[RTC – Real-Time Counter](#)

[Real-Time Counter Clock Selection](#)

[GCLK - Generic Clock Controller](#)

### 22.6.6 Watchdog Timer Clock Selection

The Watchdog Timer (WDT) uses the internal 1.024kHz OSCULP32K output clock. This clock is running all the time and internally enabled when requested by the WDT module.

#### Related Links

[WDT – Watchdog Timer](#)

## 22.6.7 Real-Time Counter Clock Selection

Before enabling the RTC module, the RTC clock must be selected first. All oscillator outputs are valid as RTC clock. The selection is done in the RTC Control register (RTCCTRL). To ensure a proper operation, it is highly recommended to disable the RTC module first, before the RTC clock source selection is changed.

### Related Links

[RTC – Real-Time Counter](#)

## 22.6.8 Interrupts

The OSC32KCTRL has the following interrupt sources:

- XOSC32KRDY - 32KHz Crystal Oscillator Ready: A 0-to-1 transition on the STATUS.XOSC32KRDY bit is detected
- CLKFAIL - Clock Failure Detector: A 0-to-1 transition on the STATUS.CLKFAIL bit is detected
- OSC32KRDY - 32KHz Internal Oscillator Ready: A 0-to-1 transition on the STATUS.OSC32KRDY bit is detected

All these interrupts are synchronous wake-up source.

Each interrupt source has an interrupt flag associated with it. The interrupt flag in the Interrupt Flag Status and Clear register (INTFLAG) is set when the interrupt condition occurs. Each interrupt can be enabled individually by setting the corresponding bit in the Interrupt Enable Set register (INTENSET), and disabled by setting the corresponding bit in the Interrupt Enable Clear register (INTENCLR). An interrupt request is generated when the interrupt flag is set and the corresponding interrupt is enabled. The interrupt request remains active until the interrupt flag is cleared, the interrupt is disabled or the OSC32KCTRL is reset. See the INTFLAG register for details on how to clear interrupt flags.

The OSC32KCTRL has one common interrupt request line for all the interrupt sources. The user must read the INTFLAG register to determine which interrupt condition is present. Refer to the INTFLAG register for details.

**Note:** Interrupts must be globally enabled for interrupt requests to be generated.

### Related Links

[PM – Power Manager](#)

[Nested Vector Interrupt Controller](#)

## 22.6.9 Events

The CFD can generate the following output event:

- Clock Failure Detector (CLKFAIL): Generated when the Clock Failure Detector status bit is set in the Status register (STATUS.CLKFAIL). The CFD event is not generated when the Clock Switch bit (STATUS.SWBACK) in the Status register is set.

Writing a '1' to an Event Output bit in the Event Control register (EVCTRL.CFDEO) enables the CFD output event. Writing a '0' to this bit disables the CFD output event. Refer to the Event System chapter for details on configuring the event system.

## 22.7 Register Summary

Offset	Name	Bit Pos.									
0x00	INTENCLR	7:0						CLKFAIL	OSC32KRDY	XOSC32KRDY	
0x01		15:8									
0x02		23:16									
0x03		31:24									
0x04	INTENSET	7:0						CLKFAIL	OSC32KRDY	XOSC32KRDY	
0x05		15:8									
0x06		23:16									
0x07		31:24									
0x08	INTFLAG	7:0						CLKFAIL	OSC32KRDY	XOSC32KRDY	
0x09		15:8									
0x0A		23:16									
0x0B		31:24									
0x0C	STATUS	7:0				CLKSW		CLKFAIL	OSC32KRDY	XOSC32KRDY	
0x0D		15:8									
0x0E		23:16									
0x0F		31:24									
0x10	RTCCTRL	7:0							RTCSEL[2:0]		
0x11		15:8									
0x12		23:16									
0x13		31:24									
0x14	XOSC32K	7:0	ONDEMAND	RUNSTDBY		EN1K	EN32K	XTALEN	ENABLE		
0x15		15:8				WRTLOCK		STARTUP[2:0]			
0x16	CFDCTRL	7:0					CFDPRESC	SWBACK	CFDEN		
0x17	EVCTRL	7:0							CFDEO		
0x18	OSC32K	7:0	ONDEMAND	RUNSTDBY		EN1K	EN32K	ENABLE			
0x19		15:8				WRTLOCK		STARTUP[2:0]			
0x1A		23:16	CALIB[6:0]								
0x1B		31:24									
0x1C	OSCULP32K	7:0									
0x1D		15:8	WRTLOCK	CALIB[4:0]							
0x1E		23:16									
0x1F		31:24									

## 22.8 Register Description

Registers can be 8, 16, or 32 bits wide. Atomic 8-, 16-, and 32-bit accesses are supported. In addition, the 8-bit quarters and 16-bit halves of a 32-bit register and the 8-bit halves of a 16-bit register can be accessed directly.

All registers with write-access can be write-protected optionally by the peripheral access controller (PAC). Optional Write-Protection by the Peripheral Access Controller (PAC) is denoted by the "PAC Write-

Protection" property in the register description. Write-protection does not apply to accesses through an external debugger.

**Related Links**

[PAC - Peripheral Access Controller](#)

**22.8.1 Interrupt Enable Clear**

This register allows the user to disable an interrupt without doing a read-modify-write operation. Changes in this register will also be reflected in the Interrupt Enable Set register (INTENSET).

**Name:** INTENCLR  
**Offset:** 0x00 [ID-00001010]  
**Reset:** 0x00000000  
**Property:** PAC Write-Protection



**Bit 2 – CLKFAIL: XOSC32K Clock Failure Detection Interrupt Enable**

Writing a '0' to this bit has no effect.

Writing a '1' to this bit will clear the XOSC32K Clock Failure Interrupt Enable bit, which disables the XOSC32K Clock Failure interrupt.

Value	Description
0	The XOSC32K Clock Failure Detection is disabled.
1	The XOSC32K Clock Failure Detection is enabled. An interrupt request will be generated when the XOSC32K Clock Failure Detection interrupt flag is set.

**Bit 1 – OSC32KRDY: OSC32K Ready Interrupt Enable**

Writing a '0' to this bit has no effect.

Writing a '1' to this bit will clear the OSC32K Ready Interrupt Enable bit, which disables the OSC32K Ready interrupt.

Value	Description
0	The OSC32K Ready interrupt is disabled.
1	The OSC32K Ready interrupt is enabled.

**Bit 0 – XOSC32KRDY: XOSC32K Ready Interrupt Enable**

Writing a '0' to this bit has no effect.

Writing a '1' to this bit will clear the XOSC32K Ready Interrupt Enable bit, which disables the XOSC32K Ready interrupt.

Value	Description
0	The XOSC32K Ready interrupt is disabled.
1	The XOSC32K Ready interrupt is enabled.

## 22.8.2 Interrupt Enable Set

This register allows the user to disable an interrupt without doing a read-modify-write operation. Changes in this register will also be reflected in the Interrupt Enable Clear register (INTENCLR).

**Name:** INTENSET

**Offset:** 0x04 [ID-00001010]

**Reset:** 0x00000000

**Property:** PAC Write-Protection



**Bit 2 – CLKFAIL: XOSC32K Clock Failure Detection Interrupt Enable**

Writing a '0' to this bit has no effect.

Writing a '1' to this bit will set the XOSC32K Clock Failure Interrupt Enable bit, which enables the XOSC32K Clock Failure interrupt.

Value	Description
0	The XOSC32K Clock Failure Detection is disabled.
1	The XOSC32K Clock Failure Detection is enabled. An interrupt request will be generated when the XOSC32K Clock Failure Detection interrupt flag is set.

**Bit 1 – OSC32KRDY: OSC32K Ready Interrupt Enable**

Writing a '0' to this bit has no effect.

Writing a '1' to this bit will set the OSC32K Ready Interrupt Enable bit, which enables the OSC32K Ready interrupt.

Value	Description
0	The OSC32K Ready interrupt is disabled.
1	The OSC32K Ready interrupt is enabled.

**Bit 0 – XOSC32KRDY: XOSC32K Ready Interrupt Enable**

Writing a '0' to this bit has no effect.

Writing a '1' to this bit will set the XOSC32K Ready Interrupt Enable bit, which enables the XOSC32K Ready interrupt.

Value	Description
0	The XOSC32K Ready interrupt is disabled.
1	The XOSC32K Ready interrupt is enabled.

### 22.8.3 Interrupt Flag Status and Clear

**Name:** INTFLAG  
**Offset:** 0x08 [ID-00001010]  
**Reset:** 0x00000000  
**Property:** –

Bit	31	30	29	28	27	26	25	24	
Access									
Reset									
Bit	23	22	21	20	19	18	17	16	
Access									
Reset									
Bit	15	14	13	12	11	10	9	8	
Access									
Reset									
Bit	7	6	5	4	3	2	1	0	
						CLKFAIL	OSC32KRDY	XOSC32KRDY	
Access						R/W	R/W	R/W	
Reset						0	0	0	

**Bit 2 – CLKFAIL: XOSC32K Clock Failure Detection**

This flag is cleared by writing a '1' to it.

This flag is set on a zero-to-one transition of the XOSC32K Clock Failure Detection bit in the Status register (STATUS.CLKFAIL) and will generate an interrupt request if INTENSET.CLKFAIL is '1'.

Writing a '0' to this bit has no effect.

Writing a '1' to this bit will clear the XOSC32K Clock Failure Detection flag.

**Bit 1 – OSC32KRDY: OSC32K Ready**

This flag is cleared by writing a '1' to it.

This flag is set by a zero-to-one transition of the OSC32K Ready bit in the Status register (STATUS.OSC32KRDY), and will generate an interrupt request if INTENSET.OSC32KRDY=1.

Writing a '0' to this bit has no effect.

Writing a '1' to this bit clears the OSC32K Ready interrupt flag.

**Bit 0 – XOSC32KRDY: XOSC32K Ready**

This flag is cleared by writing a '1' to it.

This flag is set by a zero-to-one transition of the XOSC32K Ready bit in the Status register (STATUS.XOSC32KRDY), and will generate an interrupt request if INTENSET.XOSC32KRDY=1.

Writing a '0' to this bit has no effect.

Writing a '1' to this bit clears the XOSC32K Ready interrupt flag.

**22.8.4 Status**



**Name:** STATUS  
**Offset:** 0x0C [ID-00001010]  
**Reset:** 0x00000000  
**Property:** –



### Bit 3 – CLKSW: XOSC32K Clock Switch

Value	Description
0	XOSC32K is not switched and provided the crystal oscillator.
1	XOSC32K is switched to be provided by the safe clock.

### Bit 2 – CLKFAIL: XOSC32K Clock Failure Detector

Value	Description
0	XOSC32K is passing failure detection.
1	XOSC32K is not passing failure detection.

### Bit 1 – OSC32KRDY: OSC32K Ready

Value	Description
0	OSC32K is not ready.
1	OSC32K is stable and ready to be used as a clock source.

### Bit 0 – XOSC32KRDY: XOSC32K Ready

Value	Description
0	XOSC32K is not ready.
1	XOSC32K is stable and ready to be used as a clock source.

## 22.8.5 RTC Clock Selection Control

**Name:** RTCCTRL  
**Offset:** 0x10 [ID-00001010]  
**Reset:** 0x00000000  
**Property:** PAC Write-Protection



**Bits 2:0 – RTCSEL[2:0]: RTC Clock Source Selection**

These bits select the source for the RTC.

Value	Name	Description
0x0	ULP1K	1.024kHz from 32KHz internal ULP oscillator
0x1	ULP32K	32.768kHz from 32KHz internal ULP oscillator
0x2	OSC1K	1.024kHz from 32KHz internal oscillator
0x3	OSC32K	32.768kHz from 32KHz internal oscillator
0x4	XOSC1K	1.024kHz from 32KHz external oscillator
0x5	XOSC32K	32.768kHz from 32KHz external crystal oscillator
0x6	Reserved	
0x7	Reserved	

**22.8.6 32KHz External Crystal Oscillator (XOSC32K) Control**

**Name:** XOSC32K  
**Offset:** 0x14 [ID-00001010]  
**Reset:** 0x00000080  
**Property:** PAC Write-Protection

	Bit	15	14	13	12	11	10	9	8
					WRTLOCK		STARTUP[2:0]		
Access					R/W		R/W	R/W	R/W
Reset					0		0	0	0
	Bit	7	6	5	4	3	2	1	0
		ONDEMAND	RUNSTDBY		EN1K	EN32K	XTALEN	ENABLE	
Access		R/W	R/W		R/W	R/W	R/W	R/W	
Reset		1	0		0	0	0	0	

### Bit 12 – WRTLOCK: Write Lock

This bit locks the XOSC32K register for future writes, effectively freezing the XOSC32K configuration.

Value	Description
0	The XOSC32K configuration is not locked.
1	The XOSC32K configuration is locked.

### Bits 10:8 – STARTUP[2:0]: Oscillator Start-Up Time

These bits select the start-up time for the oscillator.

The OSCULP32K oscillator is used to clock the start-up counter.

**Table 22-3. Start-Up Time for 32KHz External Crystal Oscillator**

STARTUP[2:0]	Number of OSCULP32K Clock Cycles	Number of XOSC32K Clock Cycles	Approximate Equivalent Time [ms]
0x0	1	3	0.122
0x1	32	3	1.068
0x2	2048	3	62.6
0x3	4096	3	125
0x4	16384	3	500
0x5	32768	3	1000
0x6	65536	3	2000
0x7	131072	3	4000

**Note:**

1. Actual Start-Up time is 1 OSCULP32K cycle + 3 XOSC32K cycles.
2. The given time assumes an XTAL frequency of 32.768kHz.

### Bit 7 – ONDEMAND: On Demand Control

This bit controls how the XOSC32K behaves when a peripheral clock request is detected. For details, refer to [XOSC32K Sleep Behavior](#).

### Bit 6 – RUNSTDBY: Run in Standby

This bit controls how the XOSC32K behaves during standby sleep mode. For details, refer to [XOSC32K Sleep Behavior](#).

## Bit 4 – EN1K: 1KHz Output Enable

Value	Description
0	The 1KHz output is disabled.
1	The 1KHz output is enabled.

## Bit 3 – EN32K: 32KHz Output Enable

Value	Description
0	The 32KHz output is disabled.
1	The 32KHz output is enabled.

## Bit 2 – XTALEN: Crystal Oscillator Enable

This bit controls the connections between the I/O pads and the external clock or crystal oscillator.

Value	Description
0	External clock connected on XIN32. XOUT32 can be used as general-purpose I/O.
1	Crystal connected to XIN32/XOUT32.

## Bit 1 – ENABLE: Oscillator Enable

Value	Description
0	The oscillator is disabled.
1	The oscillator is enabled.

## 22.8.7 Clock Failure Detector Control

**Name:** CFDCTRL

**Offset:** 0x16

**Reset:** 0x00

**Property:** PAC Write-Protection

Bit	7	6	5	4	3	2	1	0
						CFDPRESC	SWBACK	CFDEN
Access						R/W	R/W	R/W
Reset						0	0	0

## Bit 2 – CFDPRESC: Clock Failure Detector Prescaler

This bit selects the prescaler for the Clock Failure Detector.

Value	Description
0	The CFD safe clock frequency is the OSCULP32K frequency
1	The CFD safe clock frequency is the OSCULP32K frequency divided by 2

## Bit 1 – SWBACK: Clock Switch Back

This bit controls the XOSC32K output switch back to the external clock or crystal oscillator in case of clock recovery.

Value	Description
0	The clock switch is disabled.
1	The clock switch is enabled. This bit is reset when the XOSC32K output is switched back to the external clock or crystal oscillator.

## Bit 0 – CFDEN: Clock Failure Detector Enable

This bit selects the Clock Failure Detector state.

Value	Description
0	The CFD is disabled.
1	The CFD is enabled.

### 22.8.8 Event Control

**Name:** EVCTRL

**Offset:** 0x17

**Reset:** 0x00

**Property:** PAC Write-Protection



## Bit 0 – CFDEO: Clock Failure Detector Event Out Enable

This bit controls whether the Clock Failure Detector event output is enabled and an event will be generated when the CFD detects a clock failure.

Value	Description
0	Clock Failure Detector Event output is disabled, no event will be generated.
1	Clock Failure Detector Event output is enabled, an event will be generated.

### 22.8.9 32KHz Internal Oscillator (OSC32K) Control

**Name:** OSC32K

**Offset:** 0x18 [ID-00001010]

**Reset:** 0x0000 0080 (Writing action by User required)

**Property:** PAC Write-Protection

Bit	31	30	29	28	27	26	25	24	
Access									
Reset									
Bit	23	22	21	20	19	18	17	16	
Access									
Reset									
Bit	15	14	13	12	11	10	9	8	
Access									
Reset									
Bit	7	6	5	4	3	2	1	0	
Access									
Reset									

**Bits 22:16 – CALIB[6:0]: Oscillator Calibration**

These bits control the oscillator calibration. The calibration values must be loaded by the user from the NVM Software Calibration Area.

**Bit 12 – WRTLOCK: Write Lock**

This bit locks the OSC32K register for future writes, effectively freezing the OSC32K configuration.

Value	Description
0	The OSC32K configuration is not locked.
1	The OSC32K configuration is locked.

**Bits 10:8 – STARTUP[2:0]: Oscillator Start-Up Time**

These bits select start-up time for the oscillator.

The OSCULP32K oscillator is used as input clock to the start-up counter.

**Table 22-4. Start-Up Time for 32KHz Internal Oscillator**

STARTUP[2:0]	Number of OSC32K clock cycles	Approximate Equivalent Time [ms]
0x0	3	0.092
0x1	4	0.122
0x2	6	0.183
0x3	10	0.305
0x4	18	0.549
0x5	34	1.038
0x6	66	2.014
0x7	130	3.967

**Note:**

1. Start-up time is given by STARTUP + three OSC32K cycles.
2. The given time assumes an XTAL frequency of 32.768kHz.

**Bit 7 – ONDEMAND: On Demand Control**

This bit controls how the OSC32K behaves when a peripheral clock request is detected. For details, refer to [OSC32K Sleep Behavior](#).

**Bit 6 – RUNSTDBY: Run in Standby**

This bit controls how the OSC32K behaves during standby sleep mode. For details, refer to [OSC32K Sleep Behavior](#).

**Bit 3 – EN1K: 1KHz Output Enable**

Value	Description
0	The 1KHz output is disabled.
1	The 1KHz output is enabled.

**Bit 2 – EN32K: 32KHz Output Enable**

Value	Description
0	The 32KHz output is disabled.
1	The 32KHz output is enabled.

**Bit 1 – ENABLE: Oscillator Enable**

Value	Description
0	The oscillator is disabled.
1	The oscillator is enabled.

**22.8.10 32KHz Ultra Low Power Internal Oscillator (OSCULP32K) Control**

**Name:** OSCULP32K  
**Offset:** 0x1C [ID-00001010]  
**Reset:** 0x0000XX06  
**Property:** PAC Write-Protection

Bit	31	30	29	28	27	26	25	24
	[Greyed out register bits 31-24]							
Access								
Reset								
Bit	23	22	21	20	19	18	17	16
	[Greyed out register bits 23-16]							
Access								
Reset								
Bit	15	14	13	12	11	10	9	8
	WRTLOCK	[Greyed out bits 14-13]		CALIB[4:0]				[Greyed out bit 8]
Access	R/W			R/W	R/W	R/W	R/W	R/W
Reset	0			x	x	x	x	x
Bit	7	6	5	4	3	2	1	0
	[Greyed out register bits 7-0]							
Access								
Reset								

**Bit 15 – WRTLOCK: Write Lock**

This bit locks the OSCULP32K register for future writes to fix the OSCULP32K configuration.

Value	Description
0	The OSCULP32K configuration is not locked.
1	The OSCULP32K configuration is locked.

**Bits 12:8 – CALIB[4:0]: Oscillator Calibration**

These bits control the oscillator calibration.

These bits are loaded from Flash Calibration at startup.



## 23. SUPC – Supply Controller

### 23.1 Overview

The Supply Controller (SUPC) manages the voltage reference and power supply of the device.

The SUPC controls the voltage regulators for the core (VDDCORE) domain. It sets the voltage regulators according to the sleep modes, or the user configuration. In active mode, the voltage regulators can be selected on the fly between LDO (low-dropout) type regulator or Buck converter.

The SUPC embeds two Brown-Out Detectors. BODVDD monitors the voltage applied to the device (VDD) and BODCORE monitors the internal voltage to the core (VDDCORE). The BOD can monitor the supply voltage continuously (continuous mode) or periodically (sampling mode).

The SUPC generates also a selectable reference voltage which can be used by analog modules like the ADC.

### 23.2 Features

- Voltage Regulator System
  - Main voltage regulator: LDO in active mode (MAINVREG)
  - Low Power voltage regulator in mode (LPVREG)
- Voltage Reference System
  - Reference voltage for ADC
- VDD Brown-Out Detector (BODVDD)
  - Programmable threshold
  - Threshold value loaded from NVM User Row at startup
  - Triggers resets or interrupts. Action loaded from NVM User Row
  - Operating modes:
    - Continuous mode
    - Sampled mode for low power applications with programmable sample frequency
  - Hysteresis value from Flash User Calibration
- VDDCORE Brown-Out Detector (BODCORE)
  - Internal non-configurable Brown-Out Detector

### 23.3 Block Diagram

Figure 23-1. SUPC Block Diagram

### 23.4 Signal Description

Not applicable.

#### Related Links

[I/O Multiplexing and Considerations](#)

## 23.5 Product Dependencies

In order to use this peripheral, other parts of the system must be configured correctly, as described below.

### 23.5.1 I/O Lines

Not applicable.

### 23.5.2 Power Management

The SUPC can operate in all sleep modes.

#### Related Links

[PM – Power Manager](#)

### 23.5.3 Clocks

The SUPC bus clock (CLK\_SUPC\_APB) can be enabled and disabled in the Main Clock module.

A 32KHz clock, asynchronous to the user interface clock (CLK\_SUPC\_APB), is required to run BODVDD and BODCORE in sampled mode. Due to this asynchronicity, writing to certain registers will require synchronization between the clock domains. Refer to [Synchronization](#) for further details.

#### Related Links

[OSC32KCTRL – 32KHz Oscillators Controller](#)

[Peripheral Clock Masking](#)

### 23.5.4 DMA

Not applicable.

### 23.5.5 Interrupts

The interrupt request lines are connected to the interrupt controller. Using the SUPC interrupts requires the interrupt controller to be configured first.

#### Related Links

[Nested Vector Interrupt Controller](#)

### 23.5.6 Events

Not applicable.

### 23.5.7 Debug Operation

When the CPU is halted in debug mode, the SUPC continues normal operation. If the SUPC is configured in a way that requires it to be periodically serviced by the CPU through interrupts or similar, improper operation or data loss may result during debugging.

If debugger cold-plugging is detected by the system, BODVDD and BODCORE resets will be masked. The BOD resets keep running under hot-plugging. This allows to correct a BODVDD user level too high for the available supply.

### 23.5.8 Register Access Protection

Registers with write-access can be write-protected optionally by the peripheral access controller (PAC).

**Note:** Not all registers with write-access can be write-protected.

PAC Write-Protection is not available for the following registers:

- Interrupt Flag Status and Clear register (INTFLAG)

Optional PAC Write-Protection is denoted by the "PAC Write-Protection" property in each individual register description.

#### Related Links

[PAC - Peripheral Access Controller](#)

### 23.5.9 Analog Connections

Not applicable.

## 23.6 Functional Description

### 23.6.1 Voltage Regulator System Operation

#### 23.6.1.1 Enabling, Disabling, and Resetting

The LDO main voltage regulator is enabled after any Reset. The main voltage regulator (MAINVREG) can be disabled by writing the Enable bit in the VREG register (VREG.ENABLE) to zero. The main voltage regulator output supply level is automatically defined by the sleep mode selected in the Power Manager module.

#### Related Links

[PM – Power Manager](#)

#### 23.6.1.2 Initialization

After a Reset, the LDO voltage regulator supplying VDDCORE is enabled.

#### 23.6.1.3 Sleep Mode Operation

In mode, the low power voltage regulator (LPVREG) is used to supply VDDCORE.

#### Related Links

[Sleep Mode Controller](#)

### 23.6.2 Voltage Reference System Operation

#### 23.6.2.1 Initialization

The voltage reference output disabled after any Reset.

#### 23.6.2.2 Enabling, Disabling, and Resetting

The voltage reference output is enabled/disabled by setting/clearing the Voltage Reference Output Enable bit in the Voltage Reference register (VREF.VREFOE).

#### 23.6.2.3 Selecting a Voltage Reference

The Voltage Reference Selection bit field in the VREF register (VREF.SEL) selects the voltage of INTREF to be applied to analog modules, e.g. the ADC.

#### 23.6.2.4 Sleep Mode Operation

The Voltage Reference output behavior during sleep mode can be configured using the Run in Standby bit and the On Demand bit in the Voltage Reference register (VREF.RUNSTDBY, VREF.ONDEMAND), see the following table:

**Table 23-1. VREF Sleep Mode Operation**

VREF.ONDEMAND	VREF.RUNSTDBY	Voltage Reference Sleep behavior
-	-	Disable
0	0	Always run in all sleep modes <i>except</i> standby sleep mode
0	1	Always run in all sleep modes <i>including</i> standby sleep mode
1	0	Only run if requested by the ADC, in all sleep modes <i>except</i> standby sleep mode
1	1	Only run if requested by the ADC, in all sleep modes <i>including</i> standby sleep mode

## 23.6.3 Brown-Out Detectors

### 23.6.3.1 Initialization

Before a Brown-Out Detector (BODVDD) is enabled, it must be configured, as outlined by the following:

- Set the BOD threshold level (BODVDD.LEVEL)
- Set the configuration in active, standby (BODVDD.ACTCDG, BODVDD.STDBYCFG)
- Set the prescaling value if the BOD will run in sampling mode (BODVDD.PSEL)
- Set the action and hysteresis (BODVDD.ACTION and BODVDD.HYST)

The BODVDD register is Enable-Protected, meaning that they can only be written when the BOD is disabled (BODVDD.ENABLE=0 and SYNCBUSY.BODVDDEN=0). As long as the Enable bit is '1', any writes to Enable-Protected registers will be discarded, and an APB error will be generated. The Enable bits are not Enable-Protected.

### 23.6.3.2 Enabling, Disabling, and Resetting

After power or user reset, the BODVDD and BODCORE register values are loaded from the NVM User Row.

The BODVDD is enabled by writing a '1' to the Enable bit in the BOD control register (BODVDD.ENABLE). The BOD is disabled by writing a '0' to the BODVDD.ENABLE.

#### Related Links

[NVM User Row Mapping](#)

### 23.6.3.3 VDD Brown-Out Detector (BODVDD)

The VDD Brown-Out Detector (BODVDD) is able to monitor the VDD supply and compares the voltage with the brown-out threshold level set in the BODVDD Level field (BODVDD.LEVEL) in the BODVDD register.

When VDD crosses below the brown-out threshold level, the BODVDD can generate either an interrupt or a Reset, depending on the BODVDD Action bit field (BODVDD.ACTION).

The BODVDD detection status can be read from the BODVDD Detection bit in the Status register (STATUS.BODVDDDET).

At start-up or at Power-On Reset (POR), the BODVDD register values are loaded from the NVM User Row.

#### Related Links

[NVM User Row Mapping](#)

[Brown Out Detectors Characteristics](#)

## 23.6.3.4 VDDCORE Brown-Out Detector (BODCORE)

The BODCORE is calibrated in production and its calibration configuration is stored in the NVM User Row. This configuration must not be changed to assure the correct behavior of the BODCORE. The BODCORE generates a reset when VDDCORE crosses below the preset brown-out level. The BODCORE is always disabled in standby sleep mode.

### Related Links

[NVM User Row Mapping](#)

## 23.6.3.5 Continuous Mode

Continuous mode is the default mode for BODVDD.

The BODVDD is continuously monitoring the VDD supply voltage if it is enabled (BODVDD.ENABLE=1) and if the BODVDD Configuration bit in the BODVDD register is cleared (BODVDD.ACTCFG=0 for active mode, BODVDD.STDBYCFG=0 for standby mode).

## 23.6.3.6 Sampling Mode

The Sampling Mode is a low-power mode where the BODVDD is being repeatedly enabled on a sampling clock's ticks. The BODVDD will monitor the supply voltage for a short period of time and then go to a low-power disabled state until the next sampling clock tick.

Sampling mode is enabled in Active mode for BODVDD by writing the ACTCFG bit (BODVDD.ACTCFG=1). Sampling mode is enabled in Standby mode by writing to the STDBYCFG bit (BODVDD.STBYCFG=1). The frequency of the clock ticks ( $F_{clk_{sampling}}$ ) is controlled by the Prescaler Select bit groups in the BODVDD register (BODVDD.PSEL).

$$F_{clk_{sampling}} = \frac{F_{clk_{prescaler}}}{2^{(PSEL + 1)}}$$

The prescaler signal ( $F_{clk_{prescaler}}$ ) is a 1KHz clock, output by the 32KHz Ultra Low Power Oscillator OSCULP32K.

As the sampling clock is different from the APB clock domain, synchronization among the clocks is necessary. See also [Synchronization](#).

## 23.6.3.7 Hysteresis

A hysteresis on the trigger threshold of a BOD will reduce the sensitivity to ripples on the monitored voltage: instead of switching  $\overline{RESET}$  at each crossing of  $V_{BOD}$ , the thresholds for switching  $\overline{RESET}$  on and off are separated ( $V_{BOD-}$  and  $V_{BOD+}$ , respectively).

**Figure 23-2. BOD Hysteresis Principle**

Hysteresis OFF:



Hysteresis ON:



Enabling the BODVDD hysteresis by writing the Hysteresis bit in the BODVDD register (BODVDD.HYST) to '1' will add hysteresis to the BODVDD threshold level.

The hysteresis functionality can be used in both Continuous and Sampling Mode.

### 23.6.3.8 Sleep Mode Operation

#### Standby Mode

The BODVDD can be used in standby mode if the BOD is enabled and the corresponding Run in Standby bit is written to '1' (BODVDD.RUNSTDBY).

The BODVDD can be configured to work in either Continuous or Sampling Mode by writing a '1' to the Configuration in Standby Sleep Mode bit (BODVDD.STDBYCFG).

### 23.6.4 Interrupts

The SUPC has the following interrupt sources, which are either synchronous or asynchronous wake-up sources:

- BODVDD Ready (BODVDDRDY), synchronous
- BODVDD Detection (BODVDDDET), asynchronous
- BODVDD Synchronization Ready (BVDDSRDY), synchronous

Each interrupt source has an interrupt flag associated with it. The interrupt flag in the Interrupt Flag Status and Clear register (INTFLAG) is set when the interrupt condition occurs.

Each interrupt can be individually enabled by writing a '1' to the corresponding bit in the Interrupt Enable Set register (INTENSET), and disabled by writing a '1' to the corresponding bit in the Interrupt Enable Clear register (INTENCLR).

An interrupt request is generated when the interrupt flag is set and the corresponding interrupt is enabled. The interrupt request remains active until either the interrupt flag is cleared, the interrupt is disabled, or the SUPC is reset. See the INTFLAG register for details on how to clear interrupt flags. The SUPC has one common interrupt request line for all the interrupt sources. The user must read the INTFLAG register to determine which interrupt condition is present.

**Note:** Interrupts must be globally enabled for interrupt requests to be generated.

#### Related Links

[Nested Vector Interrupt Controller](#)

[Sleep Mode Controller](#)

### 23.6.5 Synchronization

The prescaler counters that are used to trigger brown-out detections operate asynchronously from the peripheral bus. As a consequence, the BODVDD Enable bit (BODVDD.ENABLE) need synchronization when written.

The Write-Synchronization of the Enable bit is triggered by writing a '1' to the Enable bit of the BODVDD Control register. The Synchronization Ready bit (STATUS.BVDDSRDY) in the STATUS register will be cleared when the Write-Synchronization starts, and set again when the Write-Synchronization is complete. Writing to the same register while the Write-Synchronization is ongoing (STATUS.BVDDSRDY is '0') will generate an error without stalling the APB bus.

### 23.7 Register Summary

Offset	Name	Bit Pos.								
0x00	INTENCLR	7:0						BVDDSRDY	BODVDDDET	BODVDDRDY
0x01		15:8								
0x02		23:16								
0x03		31:24								
0x04	INTENSET	7:0						BVDDSRDY	BODVDDDET	BODVDDRDY
0x05		15:8								
0x06		23:16								
0x07		31:24								
0x08	INTFLAG	7:0						BVDDSRDY	BODVDDDET	BODVDDRDY
0x09		15:8								
0x0A		23:16								
0x0B		31:24								
0x0C	STATUS	7:0						BVDDSRDY	BODVDDDET	BODVDDRDY
0x0D		15:8								
0x0E		23:16								
0x0F		31:24								
0x10	BODVDD	7:0		RUNSTDBY	STDBYCFG	ACTION[1:0]		HYST	ENABLE	
0x11		15:8	PSEL[3:0]							ACTCFG
0x12		23:16	LEVEL[5:0]							
0x13		31:24								
0x14 ... 0x17	Reserved									
0x18	VREG	7:0		RUNSTDBY					ENABLE	
0x19		15:8								
0x1A		23:16								
0x1B		31:24								
0x1C	VREF	7:0	ONDEMAND	RUNSTDBY				VREFOE		
0x1D		15:8								
0x1E		23:16	SEL[3:0]							
0x1F		31:24								

### 23.8 Register Description

Registers can be 8, 16, or 32 bits wide. Atomic 8-, 16-, and 32-bit accesses are supported. In addition, the 8-bit quarters and 16-bit halves of a 32-bit register, and the 8-bit halves of a 16-bit register can be accessed directly.

Some registers are optionally write-protected by the Peripheral Access Controller (PAC). PAC Write-protection is denoted by the "PAC Write-Protection" property in each individual register description. Refer to [Register Access Protection](#) for details.

Some registers require synchronization when read and/or written. Synchronization is denoted by the "Write-Synchronized" or the "Read-Synchronized" property in each individual register description. Refer to [Synchronization](#) for details.

## 23.8.1 Interrupt Enable Clear

This register allows the user to disable an interrupt without doing a read-modify-write operation. Changes in this register will also be reflected in the Interrupt Enable Set register (INTENSET).

**Name:** INTENCLR

**Offset:** 0x00 [ID-00001e33]

**Reset:** 0x00000000

**Property:** PAC Write-Protection

Bit	31	30	29	28	27	26	25	24	
Access									
Reset									
Bit	23	22	21	20	19	18	17	16	
Access									
Reset									
Bit	15	14	13	12	11	10	9	8	
Access									
Reset									
Bit	7	6	5	4	3	2	1	0	
						BVDDSRDY	BODVDDDET	BODVDDRDY	
Access						R/W	R/W	R/W	
Reset						0	0	0	

### Bit 2 – BVDDSRDY: BODVDD Synchronization Ready Interrupt Enable

Writing a '0' to this bit has no effect.

Writing a '1' to this bit will clear the BODVDD Synchronization Ready Interrupt Enable bit, which disables the BODVDD Synchronization Ready interrupt.

Value	Description
0	The BODVDD Synchronization Ready interrupt is disabled.
1	The BODVDD Synchronization Ready interrupt is enabled, and an interrupt request will be generated when the BODVDD Synchronization Ready Interrupt flag is set.

### Bit 1 – BODVDDDET: BODVDD Detection Interrupt Enable

Writing a '0' to this bit has no effect.

Writing a '1' to this bit will clear the BODVDD Detection Interrupt Enable bit, which disables the BODVDD Detection interrupt.

Value	Description
0	The BODVDD Detection interrupt is disabled.
1	The BODVDD Detection interrupt is enabled, and an interrupt request will be generated when the BODVDD Detection Interrupt flag is set.



## Bit 0 – BODVDDRDY: BODVDD Ready Interrupt Enable

Writing a '0' to this bit has no effect.

Writing a '1' to this bit will clear the BODVDD Ready Interrupt Enable bit, which disables the BODVDD Ready interrupt.

Value	Description
0	The BODVDD Ready interrupt is disabled.
1	The BODVDD Ready interrupt is enabled, and an interrupt request will be generated when the BODVDD Ready Interrupt flag is set.

### 23.8.2 Interrupt Enable Set

This register allows the user to disable an interrupt without doing a read-modify-write operation. Changes in this register will also be reflected in the Interrupt Enable Clear register (INTENCLR).

**Name:** INTENSET

**Offset:** 0x04 [ID-00001e33]

**Reset:** 0x00000000

**Property:** PAC Write-Protection



## Bit 2 – BVDDSRDY: BODVDD Synchronization Ready Interrupt Enable

Writing a '0' to this bit has no effect.

Writing a '1' to this bit will set the BODVDD Synchronization Ready Interrupt Enable bit, which enables the BODVDD Synchronization Ready interrupt.

Value	Description
0	The BODVDD Synchronization Ready interrupt is disabled.
1	The BODVDD Synchronization Ready interrupt is enabled, and an interrupt request will be generated when the BODVDD Synchronization Ready Interrupt flag is set.

### Bit 1 – BODVDDDET: BODVDD Detection Interrupt Enable

Writing a '0' to this bit has no effect.

Writing a '1' to this bit will set the BODVDD Detection Interrupt Enable bit, which enables the BODVDD Detection interrupt.

Value	Description
0	The BODVDD Detection interrupt is disabled.
1	The BODVDD Detection interrupt is enabled, and an interrupt request will be generated when the BODVDD Detection Interrupt flag is set.

### Bit 0 – BODVDDRDY: BODVDD Ready Interrupt Enable

Writing a '0' to this bit has no effect.

Writing a '1' to this bit will set the BODVDD Ready Interrupt Enable bit, which enables the BODVDD Ready interrupt.

Value	Description
0	The BODVDD Ready interrupt is disabled.
1	The BODVDD Ready interrupt is enabled, and an interrupt request will be generated when the BODVDD Ready Interrupt flag is set.

## 23.8.3 Interrupt Flag Status and Clear

**Name:** INTFLAG

**Offset:** 0x08 [ID-00001e33]

**Reset:** 0x0000010X, X= determined from NVM User Row (0xX=0bx00y)

**Property:** -



### Bit 2 – BVDDSRDY: BODVDD Synchronization Ready

This flag is cleared by writing a '1' to it.

This flag is set on a zero-to-one transition of the BODVDD Synchronization Ready bit in the Status register (STATUS.BVDDSRDY) and will generate an interrupt request if INTENSET.BVDDSRDY=1.

Writing a '0' to this bit has no effect.

Writing a '1' to this bit clears the BODVDD Synchronization Ready interrupt flag.

#### **Bit 1 – BODVDDDET: BODVDD Detection**

This flag is cleared by writing a '1' to it.

This flag is set on a zero-to-one transition of the BODVDD Detection bit in the Status register (STATUS.BODVDDDET) and will generate an interrupt request if INTENSET.BODVDDDET=1.

Writing a '0' to this bit has no effect.

Writing a '1' to this bit clears the BODVDD Detection interrupt flag.

#### **Bit 0 – BODVDDRDY: BODVDD Ready**

This flag is cleared by writing a '1' to it.

This flag is set on a zero-to-one transition of the BODVDD Ready bit in the Status register (STATUS.BODVDDRDY) and will generate an interrupt request if INTENSET.BODVDDRDY=1.

Writing a '0' to this bit has no effect.

Writing a '1' to this bit clears the BODVDD Ready interrupt flag.

The BODVDD can be enabled.

### **23.8.4 Status**

**Name:** STATUS

**Offset:** 0x0C [ID-00001e33]

**Reset:** Determined from NVM User Row

**Property:** -

Bit	31	30	29	28	27	26	25	24	
	[Greyed out bit fields]								
Access									
Reset									
Bit	23	22	21	20	19	18	17	16	
	[Greyed out bit fields]								
Access									
Reset									
Bit	15	14	13	12	11	10	9	8	
	[Greyed out bit fields]								
Access									
Reset									
Bit	7	6	5	4	3	2	1	0	
	[Greyed out bit fields]					BVDDSRDY	BODVDDDET	BODVDDRDY	
Access						R	R	R	
Reset						0	0	y	

**Bit 2 – BVDDSRDY: BODVDD Synchronization Ready**

Value	Description
0	BODVDD synchronization is ongoing.
1	BODVDD synchronization is complete.

**Bit 1 – BODVDDDET: BODVDD Detection**

Value	Description
0	No BODVDD detection.
1	BODVDD has detected that the I/O power supply is going below the BODVDD reference value.

**Bit 0 – BODVDDRDY: BODVDD Ready**

The BODVDD can be enabled at start-up from NVM User Row.

Value	Description
0	BODVDD is not ready.
1	BODVDD is ready.

**23.8.5 VDD Brown-Out Detector (BODVDD) Control**

**Name:** BODVDD

**Offset:** 0x10 [ID-00001e33]

**Reset:** Determined from NVM User Row

**Property:** Write-Synchronized, Enable-Protected, PAC Write-Protection

Bit	31	30	29	28	27	26	25	24	
Access									
Reset									
Bit	23	22	21	20	19	18	17	16	
Access			LEVEL[5:0]						
Reset			R/W	R/W	R/W	R/W	R/W	R/W	
Reset			x	x	x	x	x	x	
Bit	15	14	13	12	11	10	9	8	
Access	PSEL[3:0]								ACTCFG
Reset	R/W	R/W	R/W	R/W					R/W
Reset	0	0	0	0					0
Bit	7	6	5	4	3	2	1	0	
Access			RUNSTDBY	STDBYCFG	ACTION[1:0]		HYST	ENABLE	
Reset			R/W	R/W	R/W	R/W	R/W	R/W	
Reset			0	0	y	y	0	z	

**Bits 21:16 – LEVEL[5:0]: BODVDD Threshold Level on VDD**

These bits set the triggering voltage threshold for the BODVDD when the BODVDD monitors the VDD.

These bits are loaded from NVM User Row at start-up.

This bit field is not synchronized.

**Bits 15:12 – PSEL[3:0]: Prescaler Select**

Selects the prescaler divide-by output for the BODVDD sampling mode. The input clock comes from the OSCULP32K 1KHz output.

Value	Name	Description
0x0	DIV2	Divide clock by 2
0x1	DIV4	Divide clock by 4
0x2	DIV8	Divide clock by 8
0x3	DIV16	Divide clock by 16
0x4	DIV32	Divide clock by 32
0x5	DIV64	Divide clock by 64
0x6	DIV128	Divide clock by 128
0x7	DIV256	Divide clock by 256
0x8	DIV512	Divide clock by 512
0x9	DIV1024	Divide clock by 1024
0xA	DIV2048	Divide clock by 2048
0xB	DIV4096	Divide clock by 4096
0xC	DIV8192	Divide clock by 8192
0xD	DIV16384	Divide clock by 16384
0xE	DIV32768	Divide clock by 32768
0xF	DIV65536	Divide clock by 65536

**Bit 8 – ACTCFG: BODVDD Configuration in Active Sleep Mode**

This bit is not synchronized.

Value	Description
0	In active mode, the BODVDD operates in continuous mode.
1	In active mode, the BODVDD operates in sampling mode.

### Bit 6 – RUNSTDBY: Run in Standby

This bit is not synchronized.

Value	Description
0	In standby sleep mode, the BODVDD is disabled.
1	In standby sleep mode, the BODVDD is enabled.

### Bit 5 – STDBYCFG: BODVDD Configuration in Standby Sleep Mode

If the RUNSTDBY bit is set to '1', the STDBYCFG bit sets the BODVDD configuration in standby sleep mode.

This bit is not synchronized.

Value	Description
0	In standby sleep mode, the BODVDD is enabled and configured in continuous mode.
1	In standby sleep mode, the BODVDD is enabled and configured in sampling mode.

### Bits 4:3 – ACTION[1:0]: BODVDD Action

These bits are used to select the BODVDD action when the supply voltage crosses below the BODVDD threshold.

These bits are loaded from NVM User Row at start-up.

This bit field is not synchronized.

Value	Name	Description
0x0	NONE	No action
0x1	RESET	The BODVDD generates a reset
0x2	INT	The BODVDD generates an interrupt
0x3	-	Reserved

### Bit 2 – HYST: Hysteresis

This bit indicates whether hysteresis is enabled for the BODVDD threshold voltage.

This bit is loaded from NVM User Row at start-up.

This bit is not synchronized.

Value	Description
0	No hysteresis.
1	Hysteresis enabled.

### Bit 1 – ENABLE: Enable

This bit is loaded from NVM User Row at start-up.

This bit is not enable-protected.

Value	Description
0	BODVDD is disabled.
1	BODVDD is enabled.

## 23.8.6 Voltage Regulator System (VREG) Control

**Name:** VREG  
**Offset:** 0x18 [ID-00001e33]  
**Reset:** 0x00000000  
**Property:** PAC Write-Protection

Bit	31	30	29	28	27	26	25	24
Access	R	R	R	R	R	R	R	R
Reset	0	0	0	0	0	0	0	0
Bit	23	22	21	20	19	18	17	16
Access	R	R	R	R	R	R	R	R
Reset	0	0	0	0	0	0	0	0
Bit	15	14	13	12	11	10	9	8
Access	R	R	R	R	R	R	R	R
Reset	0	0	0	0	0	0	0	0
Bit	7	6	5	4	3	2	1	0
		RUNSTDBY					ENABLE	
Access	R	R/W	R	R	R	R	R/W	R
Reset	0	0	0	0	0	0	0	0

### Bit 6 – RUNSTDBY: Run in Standby

Value	Description
0	The voltage regulator is in low power mode in Standby sleep mode.
1	The voltage regulator is in normal mode in Standby sleep mode.

### Bit 1 – ENABLE: Enable

Value	Description
0	The voltage regulator is disabled.
1	The voltage regulator is enabled.

## 23.8.7 Voltage References System (VREF) Control

**Name:** VREF  
**Offset:** 0x1C [ID-00001e33]  
**Reset:** 0x00000000  
**Property:** PAC Write-Protection

Bit	31	30	29	28	27	26	25	24
Access								
Reset								
Bit	23	22	21	20	19	18	17	16
Access					SEL[3:0]			
Reset					R/W	R/W	R/W	R/W
					0	0	0	0
Bit	15	14	13	12	11	10	9	8
Access								
Reset								
Bit	7	6	5	4	3	2	1	0
Access	ONDEMAND	RUNSTDBY				VREFOE		
Reset	R/W	R/W				R/W		
	0	0				0		

### Bits 19:16 – SEL[3:0]: Voltage Reference Selection

These bits select the Voltage Reference for the ADC.

Value	Description
0x0	1.024V voltage reference typical value.
0x2	2.048V voltage reference typical value.
0x3	4.096V voltage reference typical value.
Others	Reserved

### Bit 7 – ONDEMAND: On Demand Control

The On Demand operation mode allows to enable or disable the voltage reference depending on peripheral requests.

Value	Description
0	The voltage reference is always on, if enabled.
1	The voltage reference is enabled when a peripheral is requesting it. The voltage reference is disabled if no peripheral is requesting it.

### Bit 6 – RUNSTDBY: Run In Standby

The bit controls how the voltage reference behaves during standby sleep mode.

Value	Description
0	The voltage reference is halted during standby sleep mode.
1	The voltage reference is not stopped in standby sleep mode. If VREF.ONDEMAND=1, the voltage reference will be running when a peripheral is requesting it. If VREF.ONDEMAND=0, the voltage reference will always be running in standby sleep mode.

### Bit 2 – VREFOE: Voltage Reference Output Enable

Value	Description
0	The Voltage Reference output is not available as an ADC input channel.
1	The Voltage Reference output is routed to an ADC input channel.



## 24. WDT – Watchdog Timer

### 24.1 Overview

The Watchdog Timer (WDT) is a system function for monitoring correct program operation. It makes it possible to recover from error situations such as runaway or deadlocked code. The WDT is configured to a predefined time-out period, and is constantly running when enabled. If the WDT is not cleared within the time-out period, it will issue a system reset. An early-warning interrupt is available to indicate an upcoming watchdog time-out condition.

The window mode makes it possible to define a time slot (or window) inside the total time-out period during which the WDT must be cleared. If the WDT is cleared outside this window, either too early or too late, a system reset will be issued. Compared to the normal mode, this can also catch situations where a code error causes the WDT to be cleared frequently.

When enabled, the WDT will run in active mode and all sleep modes. It is asynchronous and runs from a CPU-independent clock source. The WDT will continue operation and issue a system reset or interrupt even if the main clocks fail.

### 24.2 Features

- Issues a system reset if the Watchdog Timer is not cleared before its time-out period
- Early Warning interrupt generation
- Asynchronous operation from dedicated oscillator
- Two types of operation
  - Normal
  - Window mode
- Selectable time-out periods
  - From 8 cycles to 16,384 cycles in Normal mode
  - From 16 cycles to 32,768 cycles in Window mode
- Always-On capability

### 24.3 Block Diagram

Figure 24-1. WDT Block Diagram



### 24.4 Signal Description

Not applicable.

### 24.5 Product Dependencies

In order to use this peripheral, other parts of the system must be configured correctly, as described below.

#### 24.5.1 I/O Lines

Not applicable.

#### 24.5.2 Power Management

The WDT can continue to operate in any sleep mode where the selected source clock is running. The WDT interrupts can be used to wake up the device from sleep modes. The events can trigger other operations in the system without exiting sleep modes.

#### Related Links

[PM – Power Manager](#)

#### 24.5.3 Clocks

The WDT bus clock (CLK\_WDT\_APB) can be enabled and disabled (masked) in the Main Clock module (MCLK).

A 1KHz oscillator clock (CLK\_WDT\_OSC) is required to clock the WDT internal counter. This clock must be configured and enabled in the 32KHz Oscillator Controller (OSC32KCTRL) before using the WDT.

CLK\_WDT\_OSC is normally sourced from the clock of the internal ultra-low-power oscillator, OSCULP32K. Due to the ultra-low-power design, the oscillator is not very accurate, and so the exact time-out period may vary from device to device. This variation must be kept in mind when designing software that uses the WDT to ensure that the time-out periods used are valid for all devices.

The counter clock CLK\_WDT\_OSC is asynchronous to the bus clock (CLK\_WDT\_APB). Due to this asynchronicity, writing to certain registers will require synchronization between the clock domains. Refer to [Synchronization](#) for further details.

#### Related Links

[Peripheral Clock Masking](#)

[OSC32KCTRL – 32KHz Oscillators Controller](#)

#### 24.5.4 DMA

Not applicable.

#### 24.5.5 Interrupts

The interrupt request line is connected to the interrupt controller. Using the WDT interrupt(s) requires the interrupt controller to be configured first.

#### Related Links

[Nested Vector Interrupt Controller](#)

[Overview](#)

[Interrupt Line Mapping](#)

#### 24.5.6 Events

Not applicable.

#### 24.5.7 Debug Operation

When the CPU is halted in debug mode the WDT will halt normal operation.

#### 24.5.8 Register Access Protection

All registers with write-access can be write-protected optionally by the Peripheral Access Controller (PAC), except for the following registers:

- Interrupt Flag Status and Clear (INTFLAG) register

Optional write-protection by the Peripheral Access Controller (PAC) is denoted by the "PAC Write-Protection" property in each individual register description.

PAC write-protection does not apply to accesses through an external debugger.

#### 24.5.9 Analog Connections

Not applicable.

## 24.6 Functional Description

#### 24.6.1 Principle of Operation

The Watchdog Timer (WDT) is a system for monitoring correct program operation, making it possible to recover from error situations such as runaway code, by issuing a Reset. When enabled, the WDT is a constantly running timer that is configured to a predefined time-out period. Before the end of the time-out period, the WDT should be set back, or else, a system Reset is issued.

The WDT has two modes of operation, Normal mode and Window mode. Both modes offer the option of Early Warning interrupt generation. The description for each of the basic modes is given below. The settings in the Control A register (CTRLA) and the Interrupt Enable register (handled by INTENCLR/INTENSET) determine the mode of operation:

**Table 24-1. WDT Operating Modes**

CTRLA.ENABLE	CTRLA.WEN	Interrupt Enable	Mode
0	x	x	Stopped
1	0	0	Normal mode
1	0	1	Normal mode with Early Warning interrupt
1	1	0	Window mode
1	1	1	Window mode with Early Warning interrupt

## 24.6.2 Basic Operation

### 24.6.2.1 Initialization

The following bits are enable-protected, meaning that they can only be written when the WDT is disabled (CTRLA.ENABLE=0):

- Control A register (CTRLA), except the Enable bit (CTRLA.ENABLE)
- Configuration register (CONFIG)
- Early Warning Interrupt Control register (EWCTRL)

Enable-protected bits in the CTRLA register can be written at the same time as CTRLA.ENABLE is written to '1', but not at the same time as CTRLA.ENABLE is written to '0'.

The WDT can be configured only while the WDT is disabled. The WDT is configured by defining the required Time-Out Period bits in the Configuration register (CONFIG.PER). If Window mode operation is desired, the Window Enable bit in the Control A register must be set (CTRLA.WEN=1) and the Window Period bits in the Configuration register (CONFIG.WINDOW) must be defined.

Enable-protection is denoted by the "Enable-Protected" property in the register description.

### 24.6.2.2 Configurable Reset Values

After a Power-on Reset, some registers will be loaded with initial values from the NVM User Row.

This includes the following bits and bit groups:

- Enable bit in the Control A register, CTRLA.ENABLE
- Always-On bit in the Control A register, CTRLA.ALWAYSON
- Watchdog Timer Windows Mode Enable bit in the Control A register, CTRLA.WEN
- Watchdog Timer Windows Mode Time-Out Period bits in the Configuration register, CONFIG.WINDOW
- Time-Out Period bits in the Configuration register, CONFIG.PER
- Early Warning Interrupt Time Offset bits in the Early Warning Interrupt Control register, EWCTRL.EWOFFSET

#### Related Links

[NVM User Row Mapping](#)

### 24.6.2.3 Enabling, Disabling, and Resetting

The WDT is enabled by writing a '1' to the Enable bit in the Control A register (CTRLA.ENABLE). The WDT is disabled by writing a '0' to CTRLA.ENABLE.

The WDT can be disabled only if the Always-On bit in the Control A register (CTRLA.ALWAYSON) is '0'.

## 24.6.2.4 Normal Mode

In Normal mode operation, the length of a time-out period is configured in CONFIG.PER. The WDT is enabled by writing a '1' to the Enable bit in the Control A register (CTRLA.ENABLE). Once enabled, the WDT will issue a system reset if a time-out occurs. This can be prevented by clearing the WDT at any time during the time-out period.

The WDT is cleared and a new WDT time-out period is started by writing 0xA5 to the Clear register (CLEAR). Writing any other value than 0xA5 to CLEAR will issue an immediate system reset.

There are 12 possible WDT time-out ( $TO_{WDT}$ ) periods, selectable from 8ms to 16s.

By default, the early warning interrupt is disabled. If it is desired, the Early Warning Interrupt Enable bit in the Interrupt Enable register (INTENSET.EW) must be written to '1'. The Early Warning Interrupt is disabled again by writing a '1' to the Early Warning Interrupt bit in the Interrupt Enable Clear register (INTENCLR.EW).

If the Early Warning Interrupt is enabled, an interrupt is generated prior to a WDT time-out condition. In Normal mode, the Early Warning Offset bits in the Early Warning Interrupt Control register, EWCTRL.EWOFFSET, define the time when the early warning interrupt occurs. The Normal mode operation is illustrated in the figure Normal-Mode Operation.

**Figure 24-2. Normal-Mode Operation**

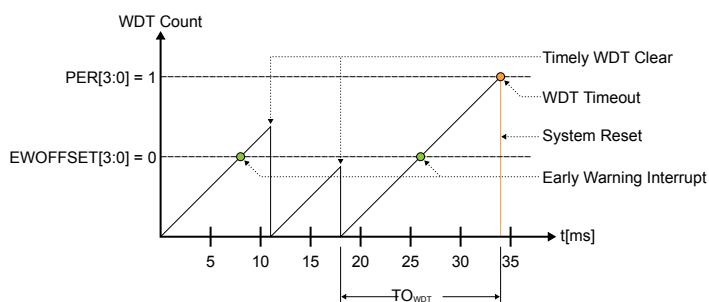

## 24.6.2.5 Window Mode

In Window mode operation, the WDT uses two different time specifications: the WDT can only be cleared by writing 0xA5 to the CLEAR register *after* the closed window time-out period ( $TO_{WDTW}$ ), during the subsequent Normal time-out period ( $TO_{WDT}$ ). If the WDT is cleared before the time window opens (before  $TO_{WDTW}$  is over), the WDT will issue a system reset.

Both parameters  $TO_{WDTW}$  and  $TO_{WDT}$  are periods in a range from 8ms to 16s, so the total duration of the WDT time-out period is the sum of the two parameters.

The closed window period is defined by the Window Period bits in the Configuration register (CONFIG.WINDOW), and the open window period is defined by the Period bits in the Configuration register (CONFIG.PER).

By default, the Early Warning interrupt is disabled. If it is desired, the Early Warning Interrupt Enable bit in the Interrupt Enable register (INTENSET.EW) must be written to '1'. The Early Warning Interrupt is disabled again by writing a '1' to the Early Warning Interrupt bit in the Interrupt Enable Clear (INTENCLR.EW) register.

If the Early Warning interrupt is enabled in Window mode, the interrupt is generated at the start of the open window period, i.e. after  $TO_{WDTW}$ . The Window mode operation is illustrated in figure Window-Mode Operation.

Figure 24-3. Window-Mode Operation



**24.6.3 DMA Operation**

Not applicable.

**24.6.4 Interrupts**

The WDT has the following interrupt source:

- Early Warning (EW): Indicates that the counter is approaching the time-out condition.
  - This interrupt is an asynchronous wake-up source.

Each interrupt source has an interrupt flag associated with it. The interrupt flag in the Interrupt Flag Status and Clear (INTFLAG) register is set when the interrupt condition occurs.

Each interrupt can be individually enabled by writing a '1' to the corresponding bit in the Interrupt Enable Set (INTENSET) register, and disabled by writing a '1' to the corresponding bit in the Interrupt Enable Clear (INTENCLR) register.

An interrupt request is generated when the interrupt flag is set and the corresponding interrupt is enabled. The interrupt request remains active until the interrupt flag is cleared, the interrupt is disabled, or the WDT is reset. See the [INTFLAG](#) register description for details on how to clear interrupt flags. All interrupt requests from the peripheral are ORed together on system level to generate one combined interrupt request to the NVIC. The user must read the INTFLAG register to determine which interrupt condition is present.

**Note:** Interrupts must be globally enabled for interrupt requests to be generated.

**Related Links**

- [Nested Vector Interrupt Controller Overview](#)
- [Interrupt Line Mapping](#)
- [PM – Power Manager](#)
- [Sleep Mode Controller](#)

**24.6.5 Events**

Not applicable.

**24.6.6 Sleep Mode Operation**

The WDT will continue to operate in any sleep mode where the source clock is active. The WDT interrupts can be used to wake up the device from a sleep mode. An interrupt request will be generated after the wake-up if the Interrupt Controller is configured accordingly. Otherwise the CPU will wake up directly, without triggering an interrupt. In this case, the CPU will continue executing from the instruction following the entry into sleep.

## Related Links

[CTRLA](#)

### 24.6.7 Synchronization

Due to asynchronicity between the main clock domain and the peripheral clock domains, some registers need to be synchronized when written or read.

The following registers are synchronized when written:

- Enable bit in Control A register (CTRLA.ENABLE)
- Window Enable bit in Control A register (CTRLA.WEN)
- Always-On bit in control Control A (CTRLA.ALWAYSON)

The following registers are synchronized when read:

- Watchdog Clear register (CLEAR)

Required write-synchronization is denoted by the "Write-Synchronized" property in the register description.

Required read-synchronization is denoted by the "Read-Synchronized" property in the register description.

### 24.6.8 Additional Features

#### 24.6.8.1 Always-On Mode

The Always-On mode is enabled by setting the Always-On bit in the Control A register (CTRLA.ALWAYSON=1). When the Always-On mode is enabled, the WDT runs continuously, regardless of the state of CTRLA.ENABLE. Once written, the Always-On bit can only be cleared by a power-on reset. The Configuration (CONFIG) and Early Warning Control (EWCTRL) registers are read-only registers while the CTRLA.ALWAYSON bit is set. Thus, the time period configuration bits (CONFIG.PER, CONFIG.WINDOW, EWCTRL.EWOFFSET) of the WDT cannot be changed.

Enabling or disabling Window mode operation by writing the Window Enable bit (CTRLA.WEN) is allowed while in Always-On mode, but note that CONFIG.PER cannot be changed.

The Interrupt Clear and Interrupt Set registers are accessible in the Always-On mode. The Early Warning interrupt can still be enabled or disabled while in the Always-On mode, but note that EWCTRL.EWOFFSET cannot be changed.

Table WDT Operating Modes With Always-On shows the operation of the WDT for CTRLA.ALWAYSON=1.

**Table 24-2. WDT Operating Modes With Always-On**

WEN	Interrupt Enable	Mode
0	0	Always-on and normal mode
0	1	Always-on and normal mode with Early Warning interrupt
1	0	Always-on and window mode
1	1	Always-on and window mode with Early Warning interrupt

#### 24.6.8.2 Early Warning

The Early Warning interrupt notifies that the WDT is approaching its time-out condition. The Early Warning interrupt behaves differently in Normal mode and in Window mode.

*In Normal mode*, the Early Warning interrupt generation is defined by the Early Warning Offset in the Early Warning Control register (EWCTRL.EWOFFSET). The Early Warning Offset bits define the number of CLK\_WDT\_OSC clocks before the interrupt is generated, relative to the start of the watchdog time-out period.

The user must take caution when programming the Early Warning Offset bits. If these bits define an Early Warning interrupt generation time greater than the watchdog time-out period, the watchdog time-out system reset is generated prior to the Early Warning interrupt. Consequently, the Early Warning interrupt will never be generated.

*In window mode*, the Early Warning interrupt is generated at the start of the open window period. In a typical application where the system is in sleep mode, the Early Warning interrupt can be used to wake up and clear the Watchdog Timer, after which the system can perform other tasks or return to sleep mode.

If the WDT is operating in Normal mode with CONFIG.PER = 0x2 and EWCTRL.EWOFFSET = 0x1, the Early Warning interrupt is generated 16 CLK\_WDT\_OSC clock cycles after the start of the time-out period. The time-out system reset is generated 32 CLK\_WDT\_OSC clock cycles after the start of the watchdog time-out period.



## 24.7 Register Summary

Offset	Name	Bit Pos.								
0x00	<a href="#">CTRLA</a>	7:0	ALWAYSON					WEN	ENABLE	
0x01	<a href="#">CONFIG</a>	7:0	WINDOW[3:0]			PER[3:0]				
0x02	<a href="#">EWCTRL</a>	7:0				EWOFFSET[3:0]				
0x03	Reserved									
0x04	<a href="#">INTENCLR</a>	7:0								EW
0x05	<a href="#">INTENSET</a>	7:0								EW
0x06	<a href="#">INTFLAG</a>	7:0								EW
0x07	Reserved									
0x08	<a href="#">SYNDBUSY</a>	7:0			CLEAR	ALWAYSON	WEN	ENABLE		
0x09		15:8								
0x0A		23:16								
0x0B		31:24								
0x0C	<a href="#">CLEAR</a>	7:0	CLEAR[7:0]							

## 24.8 Register Description

Registers can be 8, 16, or 32 bits wide. Atomic 8-, 16- and 32-bit accesses are supported. In addition, the 8-bit quarters and 16-bit halves of a 32-bit register, and the 8-bit halves of a 16-bit register can be accessed directly.

Some registers are optionally write-protected by the Peripheral Access Controller (PAC). Optional PAC write-protection is denoted by the "PAC Write-Protection" property in each individual register description. For details, refer to [Register Access Protection](#).

Some registers are synchronized when read and/or written. Synchronization is denoted by the "Write-Synchronized" or the "Read-Synchronized" property in each individual register description. For details, refer to [Synchronization](#).

Some registers are enable-protected, meaning they can only be written when the peripheral is disabled. Enable-protection is denoted by the "Enable-Protected" property in each individual register description.

### 24.8.1 Control A

**Name:** CTRLA  
**Offset:** 0x00 [ID-0000067a]  
**Reset:** Loaded from NVM User Row at start-up  
**Property:** PAC Write-Protection, Write-Synchronized

Bit	7	6	5	4	3	2	1	0
	ALWAYSON					WEN	ENABLE	
Access	R/W					R/W	R/W	
Reset	0					0	0	

#### Bit 7 – ALWAYSON: Always-On

This bit allows the WDT to run continuously. After being set, this bit cannot be written to '0', and the WDT will remain enabled until a power-on Reset is received. When this bit is '1', the Control A register

(CTRLA), the Configuration register (CONFIG) and the Early Warning Control register (EWCTRL) will be read-only, and any writes to these registers are not allowed.

Writing a '0' to this bit has no effect.

This bit is not Enable-Protected.

This bit is loaded from NVM User Row at start-up.

Value	Description
0	The WDT is enabled and disabled through the ENABLE bit.
1	The WDT is enabled and can only be disabled by a power-on reset (POR).

### Bit 2 – WEN: Watchdog Timer Window Mode Enable

This bit enables Window mode. It can only be written if the peripheral is disabled unless CTRLA.ALWAYSON=1. The initial value of this bit is loaded from Flash Calibration.

This bit is loaded from NVM User Row at startup.

Value	Description
0	Window mode is disabled (normal operation).
1	Window mode is enabled.

### Bit 1 – ENABLE: Enable

This bit enables or disables the WDT. It can only be written if CTRLA.ALWAYSON=0.

Due to synchronization, there is delay between writing CTRLA.ENABLE until the peripheral is enabled/disabled. The value written to CTRLA.ENABLE will read back immediately, and the Enable bit in the Synchronization Busy register (SYNCBUSY.ENABLE) will be set. SYNCBUSY.ENABLE will be cleared when the operation is complete.

This bit is not Enable-Protected.

This bit is loaded from NVM User Row at startup.

Value	Description
0	The WDT is disabled.
1	The WDT is enabled.

## 24.8.2 Configuration

**Name:** CONFIG

**Offset:** 0x01 [ID-0000067a]

**Reset:** Loaded from NVM User Row at start-up

**Property:** PAC Write-Protection

Bit	7	6	5	4	3	2	1	0
	WINDOW[3:0]				PER[3:0]			
Access	R/W	R/W	R/W	R/W	R/W	R/W	R/W	R/W
Reset	0	0	0	0	0	0	0	0

### Bits 7:4 – WINDOW[3:0]: Window Mode Time-Out Period

In Window mode, these bits determine the watchdog closed window period as a number of cycles of the 1.024kHz CLK\_WDT\_OSC clock.

These bits are loaded from NVM User Row at start-up.

Value	Name	Description
0x0	CYC8	8 clock cycles
0x1	CYC16	16 clock cycles
0x2	CYC32	32 clock cycles
0x3	CYC64	64 clock cycles
0x4	CYC128	128 clock cycles
0x5	CYC256	256 clock cycles
0x6	CYC512	512 clock cycles
0x7	CYC1024	1024 clock cycles
0x8	CYC2048	2048 clock cycles
0x9	CYC4096	4096 clock cycles
0xA	CYC8192	8192 clock cycles
0xB	CYC16384	16384 clock cycles
0xC - 0xF	-	Reserved

### Bits 3:0 – PER[3:0]: Time-Out Period

These bits determine the watchdog time-out period as a number of 1.024kHz CLK\_WDTOSC clock cycles. In Window mode operation, these bits define the open window period.

These bits are loaded from NVM User Row at startup.

Value	Name	Description
0x0	CYC8	8 clock cycles
0x1	CYC16	16 clock cycles
0x2	CYC32	32 clock cycles
0x3	CYC64	64 clock cycles
0x4	CYC128	128 clock cycles
0x5	CYC256	256 clock cycles
0x6	CYC512	512 clock cycles
0x7	CYC1024	1024 clock cycles
0x8	CYC2048	2048 clock cycles
0x9	CYC4096	4096 clock cycles
0xA	CYC8192	8192 clock cycles
0xB	CYC16384	16384 clock cycles
0xC - 0xF	-	Reserved

### 24.8.3 Early Warning Control

**Name:** EWCTRL

**Offset:** 0x02 [ID-0000067a]

**Reset:** N/A - Loaded from NVM User Row at start-up

**Property:** PAC Write-Protection

Bit	7	6	5	4	3	2	1	0
	EWOFFSET[3:0]							
Access					R/W	R/W	R/W	R/W
Reset					0	0	0	0

### Bits 3:0 – EWOFFSET[3:0]: Early Warning Interrupt Time Offset

These bits determine the number of GCLK\_WDT clock cycles between the start of the watchdog time-out period and the generation of the Early Warning interrupt. These bits are loaded from NVM User Row at start-up.

Value	Name	Description
0x0	CYC8	8 clock cycles
0x1	CYC16	16 clock cycles
0x2	CYC32	32 clock cycles
0x3	CYC64	64 clock cycles
0x4	CYC128	128 clock cycles
0x5	CYC256	256 clock cycles
0x6	CYC512	512 clock cycles
0x7	CYC1024	1024 clock cycles
0x8	CYC2048	2048 clock cycles
0x9	CYC4096	4096 clock cycles
0xA	CYC8192	8192 clock cycles
0xB	CYC16384	16384 clock cycles
0xC - 0xF	-	Reserved

#### 24.8.4 Interrupt Enable Clear

This register allows the user to disable an interrupt without doing a read-modify-write operation. Changes in this register will also be reflected in the Interrupt Enable Set (INTENSET) register.

**Name:** INTENCLR  
**Offset:** 0x04 [ID-0000067a]  
**Reset:** 0x00  
**Property:** PAC Write-Protection

Bit	7	6	5	4	3	2	1	0
								EW
Access								R/W
Reset								0

### Bit 0 – EW: Early Warning Interrupt Enable

Writing a '0' to this bit has no effect.

Writing a '1' to this bit clears the Early Warning Interrupt Enable bit, which disables the Early Warning interrupt.

Value	Description
0	The Early Warning interrupt is disabled.
1	The Early Warning interrupt is enabled.

## 24.8.5 Interrupt Enable Set

This register allows the user to enable an interrupt without doing a read-modify-write operation. Changes in this register will also be reflected in the Interrupt Enable Clear (INTENCLR) register.

**Name:** INTENSET  
**Offset:** 0x05 [ID-0000067a]  
**Reset:** 0x00  
**Property:** PAC Write-Protection

Bit	7	6	5	4	3	2	1	0
								EW
Access								R/W
Reset								0

### Bit 0 – EW: Early Warning Interrupt Enable

Writing a '0' to this bit has no effect.

Writing a '1' to this bit sets the Early Warning Interrupt Enable bit, which enables the Early Warning interrupt.

Value	Description
0	The Early Warning interrupt is disabled.
1	The Early Warning interrupt is enabled.

## 24.8.6 Interrupt Flag Status and Clear

**Name:** INTFLAG  
**Offset:** 0x06 [ID-0000067a]  
**Reset:** 0x00  
**Property:** N/A

Bit	7	6	5	4	3	2	1	0
								EW
Access								R/W
Reset								0

### Bit 0 – EW: Early Warning

This flag is cleared by writing a '1' to it.

This flag is set when an Early Warning interrupt occurs, as defined by the EWOFFSET bit group in EWCTRL.

Writing a '0' to this bit has no effect.

Writing a '1' to this bit clears the Early Warning interrupt flag.

## 24.8.7 Synchronization Busy

**Name:** SYNCBUSY  
**Offset:** 0x08 [ID-0000067a]  
**Reset:** 0x00000000  
**Property:** -

	Bit	31	30	29	28	27	26	25	24
		<div style="display: flex; justify-content: space-between; width: 100%; height: 15px; background-color: #cccccc;"></div>							
Access									
Reset									
	Bit	23	22	21	20	19	18	17	16
		<div style="display: flex; justify-content: space-between; width: 100%; height: 15px; background-color: #cccccc;"></div>							
Access									
Reset									
	Bit	15	14	13	12	11	10	9	8
		<div style="display: flex; justify-content: space-between; width: 100%; height: 15px; background-color: #cccccc;"></div>							
Access									
Reset									
	Bit	7	6	5	4	3	2	1	0
		<div style="display: flex; justify-content: space-between; width: 100%; height: 15px; background-color: #cccccc;"></div>		<div style="display: flex; justify-content: space-between; width: 100%; height: 15px; background-color: #cccccc;"></div>	<div style="display: flex; justify-content: space-between; width: 100%; height: 15px; background-color: #cccccc;"></div>	<div style="display: flex; justify-content: space-between; width: 100%; height: 15px; background-color: #cccccc;"></div>	<div style="display: flex; justify-content: space-between; width: 100%; height: 15px; background-color: #cccccc;"></div>	<div style="display: flex; justify-content: space-between; width: 100%; height: 15px; background-color: #cccccc;"></div>	<div style="display: flex; justify-content: space-between; width: 100%; height: 15px; background-color: #cccccc;"></div>
Access				R	R	R	R		
Reset				0	0	0	0		

#### Bit 4 – CLEAR: Clear Synchronization Busy

Value	Description
0	Write synchronization of the CLEAR register is complete.
1	Write synchronization of the CLEAR register is ongoing.

#### Bit 3 – ALWAYS ON: Always-On Synchronization Busy

Value	Description
0	Write synchronization of the CTRLA.ALWAYS ON bit is complete.
1	Write synchronization of the CTRLA.ALWAYS ON bit is ongoing.

#### Bit 2 – WEN: Window Enable Synchronization Busy

Value	Description
0	Write synchronization of the CTRLA.WEN bit is complete.
1	Write synchronization of the CTRLA.WEN bit is ongoing.

#### Bit 1 – ENABLE: Enable Synchronization Busy

Value	Description
0	Write synchronization of the CTRLA.ENABLE bit is complete.
1	Write synchronization of the CTRLA.ENABLE bit is ongoing.

### 24.8.8 Clear

**Name:** CLEAR  
**Offset:** 0x0C [ID-0000067a]  
**Reset:** 0x00  
**Property:** Write-Synchronized

Bit	7	6	5	4	3	2	1	0
	CLEAR[7:0]							
Access	W	W	W	W	W	W	W	W
Reset	0	0	0	0	0	0	0	0

**Bits 7:0 – CLEAR[7:0]: Watchdog Clear**

In Normal mode, writing 0xA5 to this register during the watchdog time-out period will clear the Watchdog Timer and the watchdog time-out period is restarted.

In Window mode, any writing attempt to this register before the time-out period started (i.e., during  $TO_{WDTW}$ ) will issue an immediate system Reset. Writing 0xA5 during the time-out period  $TO_{WDT}$  will clear the Watchdog Timer and the complete time-out sequence (first  $TO_{WDTW}$  then  $TO_{WDT}$ ) is restarted.

In both modes, writing any other value than 0xA5 will issue an immediate system Reset.

## 25. RTC – Real-Time Counter

### 25.1 Overview

The Real-Time Counter (RTC) is a 32-bit counter with a 10-bit programmable prescaler that typically runs continuously to keep track of time. The RTC can wake up the device from sleep modes using the alarm/compare wake up, periodic wake up, or overflow wake up mechanisms.

The RTC can generate periodic peripheral events from outputs of the prescaler, as well as alarm/compare interrupts and peripheral events, which can trigger at any counter value. Additionally, the timer can trigger an overflow interrupt and peripheral event, and can be reset on the occurrence of an alarm/compare match. This allows periodic interrupts and peripheral events at very long and accurate intervals.

The 10-bit programmable prescaler can scale down the clock source. By this, a wide range of resolutions and time-out periods can be configured. With a 32.768kHz clock source, the minimum counter tick interval is 30.5µs, and time-out periods can range up to 36 hours. For a counter tick interval of 1s, the maximum time-out period is more than 136 years.

### 25.2 Features

- 32-bit counter with 10-bit prescaler
- Multiple clock sources
- 32-bit or 16-bit counter mode
- One 32-bit or two 16-bit compare values
- Clock/Calendar mode
  - Time in seconds, minutes, and hours (12/24)
  - Date in day of month, month, and year
  - Leap year correction
- Digital prescaler correction/tuning for increased accuracy
- Overflow, alarm/compare match and prescaler interrupts and events
  - Optional clear on alarm/compare match

### 25.3 Block Diagram

Figure 25-1. RTC Block Diagram (Mode 0 — 32-Bit Counter)





Figure 25-2. RTC Block Diagram (Mode 1 — 16-Bit Counter)



Figure 25-3. RTC Block Diagram (Mode 2 — Clock/Calendar)



**Related Links**

[32-Bit Counter \(Mode 0\)](#)

[16-Bit Counter \(Mode 1\)](#)

[Clock/Calendar \(Mode 2\)](#)

**25.4 Signal Description**

Not applicable.

**25.5 Product Dependencies**

In order to use this peripheral, other parts of the system must be configured correctly, as described below.

**25.5.1 I/O Lines**

Not applicable.

**25.5.2 Power Management**

The RTC will continue to operate in any sleep mode where the selected source clock is running. The RTC interrupts can be used to wake up the device from sleep modes. Events connected to the event system can trigger other operations in the system without exiting sleep modes. Refer to the *Power Manager* for details on the different sleep modes.

The RTC will be reset only at power-on (POR) or by setting the Software Reset bit in the Control A register (CTRLA.SWRST=1).

**Related Links**

[PM – Power Manager](#)

## 25.5.3 Clocks

The RTC bus clock (CLK\_RTC\_APB) can be enabled and disabled in the Main Clock module MCLK, and the default state of CLK\_RTC\_APB can be found in Peripheral Clock Masking section.

A 32KHz or 1KHz oscillator clock (CLK\_RTC\_OSC) is required to clock the RTC. This clock must be configured and enabled in the 32KHz oscillator controller (OSC32KCTRL) before using the RTC.

This oscillator clock is asynchronous to the bus clock (CLK\_RTC\_APB). Due to this asynchronicity, writing to certain registers will require synchronization between the clock domains. Refer to [Synchronization](#) for further details.

### Related Links

[OSC32KCTRL – 32KHz Oscillators Controller](#)

[Peripheral Clock Masking](#)

## 25.5.4 DMA

### Related Links

[DMAC – Direct Memory Access Controller](#)

## 25.5.5 Interrupts

The interrupt request line is connected to the Interrupt Controller. Using the RTC interrupt requires the Interrupt Controller to be configured first.

### Related Links

[Nested Vector Interrupt Controller](#)

## 25.5.6 Events

The events are connected to the *Event System*.

### Related Links

[EVSYS – Event System](#)

## 25.5.7 Debug Operation

When the CPU is halted in debug mode the RTC will halt normal operation. The RTC can be forced to continue operation during debugging. Refer to [DBGCTRL](#) for details.

## 25.5.8 Register Access Protection

All registers with write-access are optionally write-protected by the peripheral access controller (PAC), except the following registers:

- Interrupt Flag Status and Clear (INTFLAG) register

Write-protection is denoted by the "PAC Write-Protection" property in the register description.

Write-protection does not apply to accesses through an external debugger. Refer to the PAC - Peripheral Access Controller for details.

### Related Links

[PAC - Peripheral Access Controller](#)

## 25.5.9 Analog Connections

A 32.768kHz crystal can be connected to the XIN32 and XOUT32 pins, along with any required load capacitors. See Electrical Characteristics for details on recommended crystal characteristics and load capacitors.

## 25.6 Functional Description

### 25.6.1 Principle of Operation

The RTC keeps track of time in the system and enables periodic events, as well as interrupts and events at a specified time. The RTC consists of a 10-bit prescaler that feeds a 32-bit counter. The actual format of the 32-bit counter depends on the RTC operating mode.

The RTC can function in one of these modes:

- Mode 0 - COUNT32: RTC serves as 32-bit counter
- Mode 1 - COUNT16: RTC serves as 16-bit counter
- Mode 2 - CLOCK: RTC serves as clock/calendar with alarm functionality

### 25.6.2 Basic Operation

#### 25.6.2.1 Initialization

The following bits are enable-protected, meaning that they can only be written when the RTC is disabled (CTRLA.ENABLE=0):

- Operating Mode bits in the Control A register (CTRLA.MODE)
- Prescaler bits in the Control A register (CTRLA.PRESCALER)
- Clear on Match bit in the Control A register (CTRLA.MATCHCLR)
- Clock Representation bit in the Control A register (CTRLA.CLKREP)

The following registers are enable-protected:

- Event Control register (EVCTRL)

Enable-protected bits and registers can be changed only when the RTC is disabled (CTRLA.ENABLE=0). If the RTC is enabled (CTRLA.ENABLE=1), these operations are necessary: first write CTRLA.ENABLE=0 and check whether the write synchronization has finished, then change the desired bit field value. Enable-protected bits can be written at the same time as CTRLA.ENABLE is written to '1', but not at the same time as CTRLA.ENABLE is written to '0'.

Enable-protection is denoted by the "Enable-Protected" property in the register description.

The RTC prescaler divides the source clock for the RTC counter.

**Note:** In Clock/Calendar mode, the prescaler must be configured to provide a 1Hz clock to the counter for correct operation.

The frequency of the RTC clock (CLK\_RTC\_CNT) is given by the following formula:

$$f_{\text{CLK\_RTC\_CNT}} = \frac{f_{\text{CLK\_RTC\_OSC}}}{2^{\text{PRESCALER}}}$$

The frequency of the oscillator clock, CLK\_RTC\_OSC, is given by  $f_{\text{CLK\_RTC\_OSC}}$ , and  $f_{\text{CLK\_RTC\_CNT}}$  is the frequency of the internal prescaled RTC clock, CLK\_RTC\_CNT.

## 25.6.2.2 Enabling, Disabling, and Resetting

The RTC is enabled by setting the Enable bit in the Control A register (CTRLA.ENABLE=1). The RTC is disabled by writing CTRLA.ENABLE=0.

The RTC is reset by setting the Software Reset bit in the Control A register (CTRLA.SWRST=1). All registers in the RTC, except DEBUG, will be reset to their initial state, and the RTC will be disabled. The RTC must be disabled before resetting it.

## 25.6.2.3 32-Bit Counter (Mode 0)

When the RTC Operating Mode bits in the Control A register (CTRLA.MODE) are written to 0x0, the counter operates in 32-bit Counter mode. The block diagram of this mode is shown in [Figure 25-1](#). When the RTC is enabled, the counter will increment on every 0-to-1 transition of CLK\_RTC\_CNT. The counter will increment until it reaches the top value of 0xFFFFFFFF, and then wrap to 0x00000000. This sets the Overflow Interrupt flag in the Interrupt Flag Status and Clear register (INTFLAG.OVF).

The RTC counter value can be read from or written to the Counter Value register (COUNT) in 32-bit format.

The counter value is continuously compared with the 32-bit Compare register (COMP0). When a compare match occurs, the Compare 0 Interrupt flag in the Interrupt Flag Status and Clear register (INTFLAG.CMP0) is set on the next 0-to-1 transition of CLK\_RTC\_CNT.

If the Clear on Match bit in the Control A register (CTRLA.MATCHCLR) is '1', the counter is cleared on the next counter cycle when a compare match with COMP0 occurs. This allows the RTC to generate periodic interrupts or events with longer periods than the prescaler events. Note that when CTRLA.MATCHCLR is '1', INTFLAG.CMP0 and INTFLAG.OVF will both be set simultaneously on a compare match with COMP0.

## 25.6.2.4 16-Bit Counter (Mode 1)

When the RTC Operating Mode bits in the Control A register (CTRLA.MODE) are written to 0x1, the counter operates in 16-bit Counter mode as shown in [Figure 25-2](#). When the RTC is enabled, the counter will increment on every 0-to-1 transition of CLK\_RTC\_CNT. In 16-bit Counter mode, the 16-bit Period register (PER) holds the maximum value of the counter. The counter will increment until it reaches the PER value, and then wrap to 0x0000. This sets the Overflow Interrupt flag in the Interrupt Flag Status and Clear register (INTFLAG.OVF).

The RTC counter value can be read from or written to the Counter Value register (COUNT) in 16-bit format.

The counter value is continuously compared with the 16-bit Compare registers (COMPn, n=0..1). When a compare match occurs, the Compare n Interrupt flag in the Interrupt Flag Status and Clear register (INTFLAG.CMPn, n=0..1) is set on the next 0-to-1 transition of CLK\_RTC\_CNT.

## 25.6.2.5 Clock/Calendar (Mode 2)

When the RTC Operating Mode bits in the Control A register (CTRLA.MODE) are written to 0x2, the counter operates in Clock/Calendar mode, as shown in [Figure 25-3](#). When the RTC is enabled, the counter will increment on every 0-to-1 transition of CLK\_RTC\_CNT. The selected clock source and RTC prescaler must be configured to provide a 1Hz clock to the counter for correct operation in this mode.

The time and date can be read from or written to the Clock Value register (CLOCK) in a 32-bit time/date format. Time is represented as:

- Seconds
- Minutes
- Hours

Hours can be represented in either 12- or 24-hour format, selected by the Clock Representation bit in the Control A register (CTRLA.CLKREP). This bit can be changed only while the RTC is disabled.

The date is represented in this form:

- Day as the numeric day of the month (starting at 1)
- Month as the numeric month of the year (1 = January, 2 = February, etc.)
- Year as a value from 0x00 to 0x3F. This value must be added to a user-defined reference year. The reference year must be a leap year (2016, 2020 etc). Example: the year value 0x2D, added to a reference year 2016, represents the year 2061.

The RTC will increment until it reaches the top value of 23:59:59 December 31 of year value 0x3F, and then wrap to 00:00:00 January 1 of year value 0x00. This will set the Overflow Interrupt flag in the Interrupt Flag Status and Clear registers (INTFLAG.OVF).

The clock value is continuously compared with the 32-bit Alarm register (ALARM0). When an alarm match occurs, the Alarm 0 Interrupt flag in the Interrupt Flag Status and Clear registers (INTFLAG.ALARM0) is set on the next 0-to-1 transition of CLK\_RTC\_CNT. E.g. For a 1Hz clock counter, it means the Alarm 0 Interrupt flag is set with a delay of 1s after the occurrence of alarm match.

A valid alarm match depends on the setting of the Alarm Mask Selection bits in the Alarm 0 Mask register (MASK0.SEL). These bits determine which time/date fields of the clock and alarm values are valid for comparison and which are ignored.

If the Clear on Match bit in the Control A register (CTRLA.MATCHCLR) is set, the counter is cleared on the next counter cycle when an alarm match with ALARM0 occurs. This allows the RTC to generate periodic interrupts or events with longer periods than it would be possible with the prescaler events only (see [Periodic Intervals](#)).

**Note:** When CTRLA.MATCHCLR is 1, INTFLAG.ALARM0 and INTFLAG.OVF will both be set simultaneously on an alarm match with ALARM0.

### 25.6.3 DMA Operation

Not applicable.

### 25.6.4 Interrupts

The RTC has the following interrupt sources:

- Overflow (OVF): Indicates that the counter has reached its top value and wrapped to zero.
- Compare (CMPn): Indicates a match between the counter value and the compare register.
- Alarm (ALARM): Indicates a match between the clock value and the alarm register.
- Period n (PERn): The corresponding bit in the prescaler has toggled. Refer to [Periodic Intervals](#) for details.

Each interrupt source has an interrupt flag associated with it. The interrupt flag in the Interrupt Flag Status and Clear (INTFLAG) register is set when the interrupt condition occurs. Each interrupt can be individually enabled by setting the corresponding bit in the Interrupt Enable Set register (INTENSET=1), and disabled by setting the corresponding bit in the Interrupt Enable Clear register (INTENCLR=1).

An interrupt request is generated when the interrupt flag is raised and the corresponding interrupt is enabled. The interrupt request remains active until either the interrupt flag is cleared, the interrupt is disabled or the RTC is reset. See the description of the INTFLAG registers for details on how to clear interrupt flags.

All interrupt requests from the peripheral are ORed together on system level to generate one combined interrupt request to the NVIC. Refer to the Nested Vector Interrupt Controller for details. The user must read the INTFLAG register to determine which interrupt condition is present.

**Note:** Interrupts must be globally enabled for interrupt requests to be generated. Refer to the Nested Vector Interrupt Controller for details.

#### Related Links

[Nested Vector Interrupt Controller](#)

### 25.6.5 Events

The RTC can generate the following output events:

- Overflow (OVF): Generated when the counter has reached its top value and wrapped to zero.
- Compare (CMPn): Indicates a match between the counter value and the compare register.
- Alarm (ALARM): Indicates a match between the clock value and the alarm register.
- Period n (PERn): The corresponding bit in the prescaler has toggled. Refer to [Periodic Intervals](#) for details.
- Periodic Daily (PERD): Generated when the COUNT/CLOCK has incremented at a fixed period of time.

Setting the Event Output bit in the Event Control Register (EVCTRL.xxxEO=1) enables the corresponding output event. Writing a zero to this bit disables the corresponding output event. Refer to the EVSYS - Event System for details on configuring the event system.

#### Related Links

[EVSYS – Event System](#)

### 25.6.6 Sleep Mode Operation

The RTC will continue to operate in any sleep mode where the source clock is active. The RTC *interrupts* can be used to wake up the device from a sleep mode. RTC *events* can trigger other operations in the system without exiting the sleep mode.

An interrupt request will be generated after the wake-up if the Interrupt Controller is configured accordingly. Otherwise the CPU will wake up directly, without triggering any interrupt. In this case, the CPU will continue executing right from the first instruction that followed the entry into sleep.

### 25.6.7 Synchronization

Due to asynchronicity between the main clock domain and the peripheral clock domains, some registers need to be synchronized when written or read.

The following bits are synchronized when written:

- Software Reset bit in Control A register, CTRLA.SWRST
- Enable bit in Control A register, CTRLA.ENABLE

The following registers are synchronized when written:

- Counter Value register, COUNT
- Clock Value register, CLOCK
- Counter Period register, PER
- Compare n Value registers, COMPn
- Alarm n Value registers, ALARMn
- Frequency Correction register, FREQCORR

- Alarm n Mask register, MASKn

The following registers are synchronized when read:

- The Counter Value register, COUNT, if the Counter Read Sync Enable bit in CTRLA (CTRLA.COUNTSYNC) is '1'
- The Clock Value register, CLOCK, if the Clock Read Sync Enable bit in CTRLA (CTRLA.CLOCKSYNC) is '1'

Required write-synchronization is denoted by the "Write-Synchronized" property in the register description.

Required read-synchronization is denoted by the "Read-Synchronized" property in the register description.

### Related Links

[Register Synchronization](#)

## 25.6.8 Additional Features

### 25.6.8.1 Periodic Intervals

The RTC prescaler can generate interrupts and events at periodic intervals, allowing flexible system tick creation. Any of the upper eight bits of the prescaler (bits 2 to 9) can be the source of an interrupt/event. When one of the eight Periodic Event Output bits in the Event Control register (EVCTRL.PEEO[n=0..7]) is '1', an event is generated on the 0-to-1 transition of the related bit in the prescaler, resulting in a periodic event frequency of:

$$f_{\text{PERIODIC}(n)} = \frac{f_{\text{CLK\_RTC\_OSC}}}{2^{n+3}}$$

$f_{\text{CLK\_RTC\_OSC}}$  is the frequency of the internal prescaler clock CLK\_RTC\_OSC, and n is the position of the EVCTRL.PEEO[n] bit. For example, PER0 will generate an event every eight CLK\_RTC\_OSC cycles, PER1 every 16 cycles, etc. This is shown in the figure below.

Periodic events are independent of the prescaler setting used by the RTC counter, except if CTRLA.PRESCALER is zero. Then, no periodic events will be generated.

**Figure 25-4. Example Periodic Events**

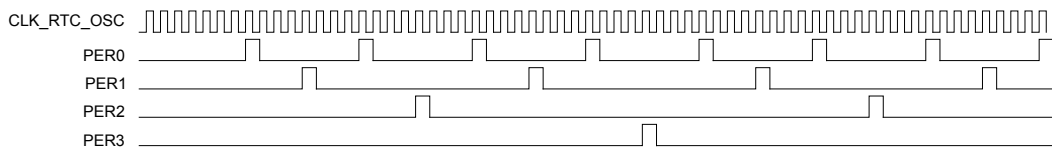

### 25.6.8.2 Frequency Correction

The RTC Frequency Correction module employs periodic counter corrections to compensate for a too-slow or too-fast oscillator. Frequency correction requires that CTRLA.PRESCALER is greater than 1.

The digital correction circuit adds or subtracts cycles from the RTC prescaler to adjust the frequency in approximately 1ppm steps. Digital correction is achieved by adding or skipping a single count in the prescaler once every 4096 CLK\_RTC\_OSC cycles. The Value bit group in the Frequency Correction register (FREQCORR.VALUE) determines the number of times the adjustment is applied over 240 of these periods. The resulting correction is as follows:

$$\text{Correction in ppm} = \frac{\text{FREQCORR.VALUE}}{4096 \cdot 240} \cdot 10^6 \text{ ppm}$$

This results in a resolution of 1.017ppm.

The Sign bit in the Frequency Correction register (FREQCORR.SIGN) determines the direction of the correction. A positive value will add counts and increase the period (reducing the frequency), and a negative value will reduce counts per period (speeding up the frequency).

Digital correction also affects the generation of the periodic events from the prescaler. When the correction is applied at the end of the correction cycle period, the interval between the previous periodic event and the next occurrence may also be shortened or lengthened depending on the correction value.



25.7 Register Summary - COUNT32

Offset	Name	Bit Pos.								
0x00	CTRLA	7:0	MATCHCLR					MODE[1:0]	ENABLE	SWRST
0x01		15:8	COUNTSYNC					PRESCALER[3:0]		
0x02 ... 0x03	Reserved									
0x04	EVCTRL	7:0	PEREOn	PEREOn	PEREOn	PEREOn	PEREOn	PEREOn	PEREOn	PEREOn
0x05		15:8	OVFEO							CMPEO0
0x06		23:16								
0x07		31:24								
0x08	INTENCLR	7:0	PERn	PERn	PERn	PERn	PERn	PERn	PERn	PERn
0x09		15:8	OVF							CMP0
0x0A	INTENSET	7:0	PERn	PERn	PERn	PERn	PERn	PERn	PERn	PERn
0x0B		15:8	OVF							CMP0
0x0C	INTFLAG	7:0	PERn	PERn	PERn	PERn	PERn	PERn	PERn	PERn
0x0D		15:8	OVF							CMP0
0x0E	DBGCTRL	7:0								DBGRUN
0x0F	Reserved									
0x10	SYNDBUSY	7:0			COMP0		COUNT	FREQCORR	ENABLE	SWRST
0x11		15:8	COUNTSYNC							
0x12		23:16								
0x13		31:24								
0x14	FREQCORR	7:0	SIGN	VALUE[6:0]						
0x15 ... 0x17	Reserved									
0x18	COUNT	7:0	COUNT[7:0]							
0x19		15:8	COUNT[15:8]							
0x1A		23:16	COUNT[23:16]							
0x1B		31:24	COUNT[31:24]							
0x1C ... 0x1F	Reserved									
0x20	COMP0	7:0	COMP[7:0]							
0x21		15:8	COMP[15:8]							
0x22		23:16	COMP[23:16]							
0x23		31:24	COMP[31:24]							

25.8 Register Description - COUNT32

This Register Description section is valid if the RTC is in COUNT32 mode (CTRLA.MODE=0).

Registers can be 8, 16, or 32 bits wide. Atomic 8-, 16-, and 32-bit accesses are supported. In addition, the 8-bit quarters and 16-bit halves of a 32-bit register, and the 8-bit halves of a 16-bit register can be accessed directly.

Some registers require synchronization when read and/or written. Synchronization is denoted by the "Read-Synchronized" and/or "Write-Synchronized" property in each individual register description.

Optional write-protection by the Peripheral Access Controller (PAC) is denoted by the "PAC Write-Protection" property in each individual register description.

Some registers are enable-protected, meaning they can only be written when the module is disabled. Enable-protection is denoted by the "Enable-Protected" property in each individual register description.

## 25.8.1 Control A in COUNT32 mode (CTRLA.MODE=0)

**Name:** CTRLA

**Offset:** 0x00

**Reset:** 0x0000

**Property:** PAC Write-Protection, Enable-Protected, Write-Synchronized

Bit	15	14	13	12	11	10	9	8
	COUNTSYNC			PRESCALER[3:0]				
Access	R/W			R/W		R/W	R/W	R/W
Reset	0			0		0	0	0
Bit	7	6	5	4	3	2	1	0
	MATCHCLR		MODE[1:0]		ENABLE		SWRST	
Access	R/W		R/W		R/W	R/W	R/W	
Reset	0		0		0	0	0	

### Bit 15 – COUNTSYNC: COUNT Read Synchronization Enable

The COUNT register requires synchronization when reading. Disabling the synchronization will prevent reading valid values from the COUNT register.

This bit is not enable-protected.

Value	Description
0	COUNT read synchronization is disabled
1	COUNT read synchronization is enabled

### Bits 11:8 – PRESCALER[3:0]: Prescaler

These bits define the prescaling factor for the RTC clock source (GCLK\_RTC) to generate the counter clock (CLK\_RTC\_CNT). Periodic events and interrupts are not available when the prescaler is off. These bits are not synchronized.

Value	Name	Description
0x0	OFF	CLK_RTC_CNT = GCLK_RTC/1
0x1	DIV1	CLK_RTC_CNT = GCLK_RTC/1
0x2	DIV2	CLK_RTC_CNT = GCLK_RTC/2
0x3	DIV4	CLK_RTC_CNT = GCLK_RTC/4
0x4	DIV8	CLK_RTC_CNT = GCLK_RTC/8
0x5	DIV16	CLK_RTC_CNT = GCLK_RTC/16
0x6	DIV32	CLK_RTC_CNT = GCLK_RTC/32
0x7	DIV64	CLK_RTC_CNT = GCLK_RTC/64
0x8	DIV128	CLK_RTC_CNT = GCLK_RTC/128
0x9	DIV256	CLK_RTC_CNT = GCLK_RTC/256

Value	Name	Description
0xA	DIV512	CLK_RTC_CNT = GCLK_RTC/512
0xB	DIV1024	CLK_RTC_CNT = GCLK_RTC/1024
0xC-0xF	-	Reserved

### Bit 7 – MATCHCLR: Clear on Match

This bit defines if the counter is cleared or not on a match.

This bit is not synchronized.

Value	Description
0	The counter is not cleared on a Compare/Alarm 0 match
1	The counter is cleared on a Compare/Alarm 0 match

### Bits 3:2 – MODE[1:0]: Operating Mode

This bit group defines the operating mode of the RTC.

This bit is not synchronized.

Value	Name	Description
0x0	COUNT32	Mode 0: 32-bit counter
0x1	COUNT16	Mode 1: 16-bit counter
0x2	CLOCK	Mode 2: Clock/calendar
0x3	-	Reserved

### Bit 1 – ENABLE: Enable

Due to synchronization there is a delay between writing CTRLA.ENABLE and until the peripheral is enabled/disabled. The value written to CTRLA.ENABLE will read back immediately and the Enable bit in the Synchronization Busy register (SYNCBUSY.ENABLE) will be set. SYNCBUSY.ENABLE will be cleared when the operation is complete.

Value	Description
0	The peripheral is disabled
1	The peripheral is enabled

### Bit 0 – SWRST: Software Reset

Writing a '0' to this bit has no effect.

Writing a '1' to this bit resets all registers in the RTC (except DBGCTRL) to their initial state, and the RTC will be disabled.

Writing a '1' to CTRLA.SWRST will always take precedence, meaning that all other writes in the same write-operation will be discarded.

Due to synchronization there is a delay between writing CTRLA.SWRST and until the reset is complete. CTRLA.SWRST will be cleared when the reset is complete.

Value	Description
0	There is not reset operation ongoing
1	The reset operation is ongoing

## 25.8.2 Event Control in COUNT32 mode (CTRLA.MODE=0)

**Name:** EVCTRL  
**Offset:** 0x04  
**Reset:** 0x00000000  
**Property:** PAC Write-Protection, Enable-Protected

	Bit	31	30	29	28	27	26	25	24
		<div style="display: flex; justify-content: space-between; width: 100%; height: 15px; background-color: #cccccc;"></div>							
Access									
Reset									
	Bit	23	22	21	20	19	18	17	16
		<div style="display: flex; justify-content: space-between; width: 100%; height: 15px; background-color: #cccccc;"></div>							
Access									
Reset									
	Bit	15	14	13	12	11	10	9	8
		OVFEO	<div style="display: flex; justify-content: space-between; width: 100%; height: 15px; background-color: #cccccc;"></div>					CMPEO0	
Access		R/W						R/W	
Reset		0						0	
	Bit	7	6	5	4	3	2	1	0
		PEREOn	PEREOn	PEREOn	PEREOn	PEREOn	PEREOn	PEREOn	PEREOn
Access		R/W	R/W	R/W	R/W	R/W	R/W	R/W	R/W
Reset		0	0	0	0	0	0	0	0

**Bit 15 – OVFEO: Overflow Event Output Enable**

Value	Description
0	Overflow event is disabled and will not be generated.
1	Overflow event is enabled and will be generated for every overflow.

**Bit 8 – CMPEO0: Compare 0 Event Output Enable**

Value	Description
0	Compare 0 event is disabled and will not be generated.
1	Compare 0 event is enabled and will be generated for every compare match.

**Bits 7:0 – PEREOn: Periodic Interval n Event Output Enable [n = 7..0]**

Value	Description
0	Periodic Interval n event is disabled and will not be generated.
1	Periodic Interval n event is enabled and will be generated.

**25.8.3 Interrupt Enable Clear in COUNT32 mode (CTRLA.MODE=0)**

This register allows the user to disable an interrupt without doing a read-modify-write operation. Changes in this register will also be reflected in the Interrupt Enable Set (INTENSET) register.

**Name:** INTENCLR  
**Offset:** 0x08  
**Reset:** 0x0000  
**Property:** PAC Write-Protection

Bit	15	14	13	12	11	10	9	8
	OVF							CMP0
Access	R/W							R/W
Reset	0							0
Bit	7	6	5	4	3	2	1	0
	PERn	PERn	PERn	PERn	PERn	PERn	PERn	PERn
Access	R/W	R/W	R/W	R/W	R/W	R/W	R/W	R/W
Reset	0	0	0	0	0	0	0	0

**Bit 15 – OVF: Overflow Interrupt Enable**

Writing a '0' to this bit has no effect.

Writing a '1' to this bit will clear the Overflow Interrupt Enable bit, which disables the Overflow interrupt.

Value	Description
0	The Overflow interrupt is disabled.
1	The Overflow interrupt is enabled.

**Bit 8 – CMP0: Compare 0 Interrupt Enable**

Writing a '0' to this bit has no effect.

Writing a '1' to this bit will clear the Compare 0 Interrupt Enable bit, which disables the Compare interrupt.

Value	Description
0	The Compare 0 interrupt is disabled.
1	The Compare 0 interrupt is enabled.

**Bits 7:0 – PERn: Periodic Interval n Interrupt Enable [n = 7..0]**

Writing a '0' to this bit has no effect.

Writing a '1' to this bit will clear the Periodic Interval n Interrupt Enable bit, which disables the Periodic Interval n interrupt.

Value	Description
0	Periodic Interval n interrupt is disabled.
1	Periodic Interval n interrupt is enabled.

**25.8.4 Interrupt Enable Set in COUNT32 mode (CTRLA.MODE=0)**

This register allows the user to enable an interrupt without doing a read-modify-write operation. Changes in this register will also be reflected in the Interrupt Enable Clear (INTENCLR) register.

**Name:** INTENSET  
**Offset:** 0x0A  
**Reset:** 0x0000  
**Property:** PAC Write-Protection

Bit	15	14	13	12	11	10	9	8
	OVF							CMP0
Access	R/W							R/W
Reset	0							0
Bit	7	6	5	4	3	2	1	0
	PERn	PERn	PERn	PERn	PERn	PERn	PERn	PERn
Access	R/W	R/W	R/W	R/W	R/W	R/W	R/W	R/W
Reset	0	0	0	0	0	0	0	0

**Bit 15 – OVF: Overflow Interrupt Enable**

Writing a '0' to this bit has no effect.

Writing a '1' to this bit will set the Overflow Interrupt Enable bit, which enables the Overflow interrupt.

Value	Description
0	The Overflow interrupt is disabled.
1	The Overflow interrupt is enabled.

**Bit 8 – CMP0: Compare 0 Interrupt Enable**

Writing a '0' to this bit has no effect.

Writing a '1' to this bit will set the Compare 0 Interrupt Enable bit, which enables the Compare 0 interrupt.

Value	Description
0	The Compare 0 interrupt is disabled.
1	The Compare 0 interrupt is enabled.

**Bits 7:0 – PERn: Periodic Interval n Interrupt Enable [n = 7..0]**

Writing a '0' to this bit has no effect.

Writing a '1' to this bit will set the Periodic Interval n Interrupt Enable bit, which enables the Periodic Interval n interrupt.

Value	Description
0	Periodic Interval n interrupt is disabled.
1	Periodic Interval n interrupt is enabled.

**25.8.5 Interrupt Flag Status and Clear in COUNT32 mode (CTRLA.MODE=0)**

This register allows the user to enable an interrupt without doing a read-modify-write operation. Changes in this register will also be reflected in the Interrupt Enable Clear (INTENCLR) register.

**Name:** INTFLAG

**Offset:** 0x0C

**Reset:** 0x0000

**Property:** -

Bit	15	14	13	12	11	10	9	8
	OVF							CMP0
Access	R/W							R/W
Reset	0							0
Bit	7	6	5	4	3	2	1	0
	PERn	PERn	PERn	PERn	PERn	PERn	PERn	PERn
Access	R/W	R/W	R/W	R/W	R/W	R/W	R/W	R/W
Reset	0	0	0	0	0	0	0	0

**Bit 15 – OVF: Overflow**

This flag is cleared by writing a '1' to the flag.

This flag is set on the next CLK\_RTC\_CNT cycle after an overflow condition occurs, and an interrupt request will be generated if INTENCLR/SET.OVF is '1'.

Writing a '0' to this bit has no effect.

Writing a '1' to this bit clears the Overflow interrupt flag.

**Bit 8 – CMP0: Compare 0**

This flag is cleared by writing a '1' to the flag.

This flag is set on the next CLK\_RTC\_CNT cycle after a match with the compare condition, and an interrupt request will be generated if INTENCLR/SET.COMP0 is one.

Writing a '0' to this bit has no effect.

Writing a '1' to this bit clears the Compare 0 interrupt flag.

**Bits 7:0 – PERn: Periodic Interval n [n = 7..0]**

This flag is cleared by writing a '1' to the flag.

This flag is set on the 0-to-1 transition of prescaler bit [n+2], and an interrupt request will be generated if INTENCLR/SET.PERx is one.

Writing a '0' to this bit has no effect.

Writing a '1' to this bit clears the Periodic Interval n interrupt flag.

**25.8.6 Debug Control**

**Name:** DBGCTRL  
**Offset:** 0x0E  
**Reset:** 0x00  
**Property:** PAC Write-Protection

Bit	7	6	5	4	3	2	1	0
								DBGRUN
Access								R/W
Reset								0

**Bit 0 – DBGRUN: Debug Run**

This bit is not reset by a software reset.

This bit controls the functionality when the CPU is halted by an external debugger.

Value	Description
0	The RTC is halted when the CPU is halted by an external debugger.
1	The RTC continues normal operation when the CPU is halted by an external debugger.

## 25.8.7 Synchronization Busy in COUNT32 mode (CTRLA.MODE=0)

**Name:** SYNCBUSY

**Offset:** 0x10

**Reset:** 0x00000000

**Property:** -

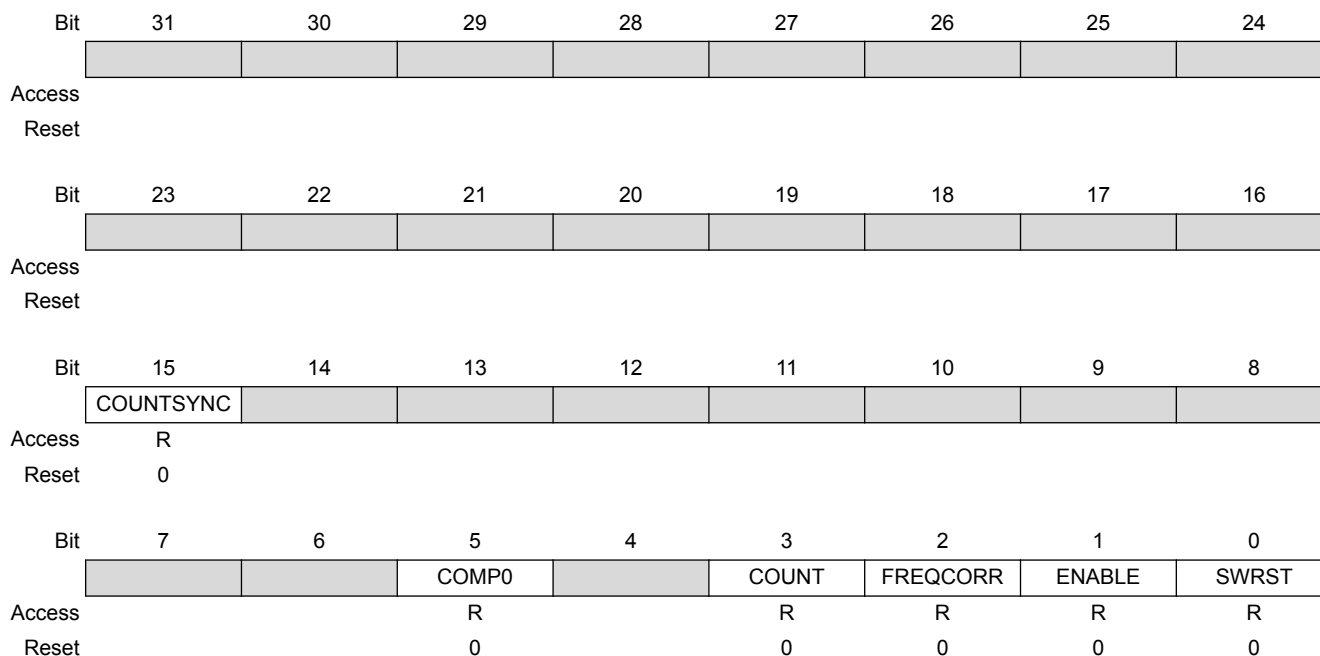

### Bit 15 – COUNTSYNC: Count Read Sync Enable Synchronization Busy Status

Value	Description
0	Write synchronization for CTRLA.COUNTSYNC bit is complete.
1	Write synchronization for CTRLA.COUNTSYNC bit is ongoing.

### Bit 5 – COMP0: Compare 0 Synchronization Busy Status

Value	Description
0	Write synchronization for COMP0 register is complete.
1	Write synchronization for COMP0 register is ongoing.

### Bit 3 – COUNT: Count Value Synchronization Busy Status

Value	Description
0	Read/write synchronization for COUNT register is complete.
1	Read/write synchronization for COUNT register is ongoing.



## Bit 2 – FREQCORR: Frequency Correction Synchronization Busy Status

Value	Description
0	Read/write synchronization for FREQCORR register is complete.
1	Read/write synchronization for FREQCORR register is ongoing.

## Bit 1 – ENABLE: Enable Synchronization Busy Status

Value	Description
0	Read/write synchronization for CTRLA.ENABLE bit is complete.
1	Read/write synchronization for CTRLA.ENABLE bit is ongoing.

## Bit 0 – SWRST: Software Reset Synchronization Busy Status

Value	Description
0	Read/write synchronization for CTRLA.SWRST bit is complete.
1	Read/write synchronization for CTRLA.SWRST bit is ongoing.

### 25.8.8 Frequency Correction

**Name:** FREQCORR

**Offset:** 0x14

**Reset:** 0x00

**Property:** PAC Write-Protection, Write-Synchronized

Bit	7	6	5	4	3	2	1	0
	SIGN	VALUE[6:0]						
Access	R/W	R/W	R/W	R/W	R/W	R/W	R/W	R/W
Reset	0	0	0	0	0	0	0	0

## Bit 7 – SIGN: Correction Sign

Value	Description
0	The correction value is positive, i.e., frequency will be decreased.
1	The correction value is negative, i.e., frequency will be increased.

## Bits 6:0 – VALUE[6:0]: Correction Value

These bits define the amount of correction applied to the RTC prescaler.

Value	Description
0	Correction is disabled and the RTC frequency is unchanged.
1 - 127	The RTC frequency is adjusted according to the value.

### 25.8.9 Counter Value in COUNT32 mode (CTRLA.MODE=0)

**Name:** COUNT

**Offset:** 0x18

**Reset:** 0x00000000

**Property:** PAC Write-Protection, Write-Synchronized, Read-Synchronized

Bit	31	30	29	28	27	26	25	24
	COUNT[31:24]							
Access	R/W	R/W	R/W	R/W	R/W	R/W	R/W	R/W
Reset	0	0	0	0	0	0	0	0
Bit	23	22	21	20	19	18	17	16
	COUNT[23:16]							
Access	R/W	R/W	R/W	R/W	R/W	R/W	R/W	R/W
Reset	0	0	0	0	0	0	0	0
Bit	15	14	13	12	11	10	9	8
	COUNT[15:8]							
Access	R/W	R/W	R/W	R/W	R/W	R/W	R/W	R/W
Reset	0	0	0	0	0	0	0	0
Bit	7	6	5	4	3	2	1	0
	COUNT[7:0]							
Access	R/W	R/W	R/W	R/W	R/W	R/W	R/W	R/W
Reset	0	0	0	0	0	0	0	0

**Bits 31:0 – COUNT[31:0]: Counter Value**

These bits define the value of the 32-bit RTC counter in mode 0.

**25.8.10 Compare 0 Value in COUNT32 mode (CTRLA.MODE=0)**

**Name:** COMP0

**Offset:** 0x20

**Reset:** 0x00000000

**Property:** PAC Write-Protection, Write-Synchronized

Bit	31	30	29	28	27	26	25	24
	COMP[31:24]							
Access	R/W	R/W	R/W	R/W	R/W	R/W	R/W	R/W
Reset	0	0	0	0	0	0	0	0
Bit	23	22	21	20	19	18	17	16
	COMP[23:16]							
Access	R/W	R/W	R/W	R/W	R/W	R/W	R/W	R/W
Reset	0	0	0	0	0	0	0	0
Bit	15	14	13	12	11	10	9	8
	COMP[15:8]							
Access	R/W	R/W	R/W	R/W	R/W	R/W	R/W	R/W
Reset	0	0	0	0	0	0	0	0
Bit	7	6	5	4	3	2	1	0
	COMP[7:0]							
Access	R/W	R/W	R/W	R/W	R/W	R/W	R/W	R/W
Reset	0	0	0	0	0	0	0	0

**Bits 31:0 – COMP[31:0]: Compare Value**

The 32-bit value of COMP0 is continuously compared with the 32-bit COUNT value. When a match occurs, the Compare 0 interrupt flag in the Interrupt Flag Status and Clear register (INTFLAG.CMP0) is set on the next counter cycle, and the counter value is cleared if CTRLA.MATCHCLR is '1'.

25.9 Register Summary - COUNT16

Offset	Name	Bit Pos.									
0x00	CTRLA	7:0						MODE[1:0]	ENABLE	SWRST	
0x01		15:8	COUNTSYNC					PRESCALER[3:0]			
0x02 ... 0x03	Reserved										
0x04	EVCTRL	7:0	PEREOn	PEREOn	PEREOn	PEREOn	PEREOn	PEREOn	PEREOn	PEREOn	
0x05		15:8	OVFEO						CMPEOn	CMPEOn	
0x06		23:16									
0x07		31:24									
0x08	INTENCLR	7:0	PERn	PERn	PERn	PERn	PERn	PERn	PERn	PERn	
0x09		15:8	OVF						CMPn	CMPn	
0x0A	INTENSET	7:0	PERn	PERn	PERn	PERn	PERn	PERn	PERn	PERn	
0x0B		15:8	OVF						CMPn	CMPn	
0x0C	INTFLAG	7:0	PERn	PERn	PERn	PERn	PERn	PERn	PERn	PERn	
0x0D		15:8	OVF						CMPn	CMPn	
0x0E	DBGCTRL	7:0								DBGRUN	
0x0F	Reserved										
0x10	SYNDBUSY	7:0		COMPn	COMPn	PER	COUNT	FREQCORR	ENABLE	SWRST	
0x11		15:8	COUNTSYNC								
0x12		23:16									
0x13		31:24									
0x14	FREQCORR	7:0	SIGN	VALUE[6:0]							
0x15 ... 0x17	Reserved										
0x18	COUNT	7:0	COUNT[7:0]								
0x19		15:8	COUNT[15:8]								
0x1A ... 0x1B	Reserved										
0x1C	PER	7:0	PER[7:0]								
0x1D		15:8	PER[15:8]								
0x1E ... 0x1F	Reserved										
0x20	COMP0	7:0	COMP[7:0]								
0x21		15:8	COMP[15:8]								
0x22	COMP1	7:0	COMP[7:0]								
0x23		15:8	COMP[15:8]								

25.10 Register Description - COUNT16

This Register Description section is valid if the RTC is in COUNT16 mode (CTRLA.MODE=1).

Registers can be 8, 16, or 32 bits wide. Atomic 8-, 16-, and 32-bit accesses are supported. In addition, the 8-bit quarters and 16-bit halves of a 32-bit register, and the 8-bit halves of a 16-bit register can be accessed directly.

Some registers require synchronization when read and/or written. Synchronization is denoted by the "Read-Synchronized" and/or "Write-Synchronized" property in each individual register description.

Optional write-protection by the Peripheral Access Controller (PAC) is denoted by the "PAC Write-Protection" property in each individual register description.

Some registers are enable-protected, meaning they can only be written when the module is disabled. Enable-protection is denoted by the "Enable-Protected" property in each individual register description.

## 25.10.1 Control A in COUNT16 mode (CTRLA.MODE=1)

**Name:** CTRLA

**Offset:** 0x00

**Reset:** 0x0000

**Property:** PAC Write-Protection, Enable-Protected, Write-Synchronized

Bit	15	14	13	12	11	10	9	8
	COUNTSYNC					PRESCALER[3:0]		
Access	R/W				R/W	R/W	R/W	R/W
Reset	0				0	0	0	0
Bit	7	6	5	4	3	2	1	0
					MODE[1:0]		ENABLE	SWRST
Access					R/W	R/W	R/W	R/W
Reset					0	0	0	0

### Bit 15 – COUNTSYNC: COUNT Read Synchronization Enable

The COUNT register requires synchronization when reading. Disabling the synchronization will prevent reading valid values from the COUNT register.

This bit is not enable-protected.

Value	Description
0	COUNT read synchronization is disabled
1	COUNT read synchronization is enabled

### Bits 11:8 – PRESCALER[3:0]: Prescaler

These bits define the prescaling factor for the RTC clock source (GCLK\_RTC) to generate the counter clock (CLK\_RTC\_CNT). Periodic events and interrupts are not available when the prescaler is off. These bits are not synchronized.

Value	Name	Description
0x0	OFF	CLK_RTC_CNT = GCLK_RTC/1
0x1	DIV1	CLK_RTC_CNT = GCLK_RTC/1
0x2	DIV2	CLK_RTC_CNT = GCLK_RTC/2
0x3	DIV4	CLK_RTC_CNT = GCLK_RTC/4
0x4	DIV8	CLK_RTC_CNT = GCLK_RTC/8
0x5	DIV16	CLK_RTC_CNT = GCLK_RTC/16
0x6	DIV32	CLK_RTC_CNT = GCLK_RTC/32

Value	Name	Description
0x7	DIV64	CLK_RTC_CNT = GCLK_RTC/64
0x8	DIV128	CLK_RTC_CNT = GCLK_RTC/128
0x9	DIV256	CLK_RTC_CNT = GCLK_RTC/256
0xA	DIV512	CLK_RTC_CNT = GCLK_RTC/512
0xB	DIV1024	CLK_RTC_CNT = GCLK_RTC/1024
0xC-0xF	-	Reserved

### Bits 3:2 – MODE[1:0]: Operating Mode

This field defines the operating mode of the RTC. This bit is not synchronized.

Value	Name	Description
0x0	COUNT32	Mode 0: 32-bit counter
0x1	COUNT16	Mode 1: 16-bit counter
0x2	CLOCK	Mode 2: Clock/calendar
0x3	-	Reserved

### Bit 1 – ENABLE: Enable

Due to synchronization there is delay from writing CTRLA.ENABLE until the peripheral is enabled/disabled. The value written to CTRLA.ENABLE will read back immediately and the Enable bit in the Synchronization Busy register (SYNCBUSY.ENABLE) will be set. SYNCBUSY.ENABLE will be cleared when the operation is complete.

Value	Description
0	The peripheral is disabled
1	The peripheral is enabled

### Bit 0 – SWRST: Software Reset

Writing a '0' to this bit has no effect.

Writing a '1' to this bit resets all registers in the RTC (except DBGCTRL) to their initial state, and the RTC will be disabled.

Writing a '1' to CTRLA.SWRST will always take precedence, meaning that all other writes in the same write-operation will be discarded.

Due to synchronization there is a delay from writing CTRLA.SWRST until the reset is complete. CTRLA.SWRST will be cleared when the reset is complete.

Value	Description
0	There is not reset operation ongoing
1	The reset operation is ongoing

## 25.10.2 Event Control in COUNT16 mode (CTRLA.MODE=1)

**Name:** EVCTRL

**Offset:** 0x04

**Reset:** 0x00000000

**Property:** PAC Write-Protection, Enable-Protected

Bit	31	30	29	28	27	26	25	24
Access								
Reset								
Bit	23	22	21	20	19	18	17	16
Access								
Reset								
Bit	15	14	13	12	11	10	9	8
	OVFEO						CMPEOn	CMPEOn
Access	R/W						R/W	R/W
Reset	0						0	0
Bit	7	6	5	4	3	2	1	0
	PEREOn	PEREOn	PEREOn	PEREOn	PEREOn	PEREOn	PEREOn	PEREOn
Access	R/W	R/W	R/W	R/W	R/W	R/W	R/W	R/W
Reset	0	0	0	0	0	0	0	0

### Bit 15 – OVFEO: Overflow Event Output Enable

Value	Description
0	Overflow event is disabled and will not be generated.
1	Overflow event is enabled and will be generated for every overflow.

### Bits 9:8 – CMPEOn: Compare n Event Output Enable [n = 1..0]

Value	Description
0	Compare n event is disabled and will not be generated.
1	Compare n event is enabled and will be generated for every compare match.

### Bits 7:0 – PEREOn: Periodic Interval n Event Output Enable [n = 7..0]

Value	Description
0	Periodic Interval n event is disabled and will not be generated. [n = 7..0]
1	Periodic Interval n event is enabled and will be generated. [n = 7..0]

#### 25.10.3 Interrupt Enable Clear in COUNT16 mode (CTRLA.MODE=1)

This register allows the user to disable an interrupt without doing a read-modify-write operation. Changes in this register will also be reflected in the Interrupt Enable Set (INTENSET) register.

**Name:** INTENCLR

**Offset:** 0x08

**Reset:** 0x0000

**Property:** PAC Write-Protection

Bit	15	14	13	12	11	10	9	8
	OVF						CMPn	CMPn
Access	R/W						R/W	R/W
Reset	0						0	0
Bit	7	6	5	4	3	2	1	0
	PERn	PERn	PERn	PERn	PERn	PERn	PERn	PERn
Access	R/W	R/W	R/W	R/W	R/W	R/W	R/W	R/W
Reset	0	0	0	0	0	0	0	0

### Bit 15 – OVF: Overflow Interrupt Enable

Writing a '0' to this bit has no effect. Writing a '1' to this bit will clear the Overflow Interrupt Enable bit, which disables the Overflow interrupt.

Value	Description
0	The Overflow interrupt is disabled.
1	The Overflow interrupt is enabled.

### Bits 9:8 – CMPn: Compare n Interrupt Enable [n = 1..0]

Writing a '0' to this bit has no effect. Writing a '1' to this bit will clear the Compare n Interrupt Enable bit, which disables the Compare n interrupt.

Value	Description
0	The Compare n interrupt is disabled.
1	The Compare n interrupt is enabled.

### Bits 7:0 – PERn: Periodic Interval n Interrupt Enable [n = 7..0]

Writing a '0' to this bit has no effect. Writing a '1' to this bit will clear the Periodic Interval n Interrupt Enable bit, which disables the Periodic Interval n interrupt.

Value	Description
0	Periodic Interval n interrupt is disabled.
1	Periodic Interval n interrupt is enabled.

#### 25.10.4 Interrupt Enable Set in COUNT16 mode (CTRLA.MODE=1)

This register allows the user to enable an interrupt without doing a read-modify-write operation. Changes in this register will also be reflected in the Interrupt Enable Clear (INTENCLR) register.

**Name:** INTENSET

**Offset:** 0x0A

**Reset:** 0x0000

**Property:** PAC Write-Protection



Bit	15	14	13	12	11	10	9	8
	OVF						CMPn	CMPn
Access	R/W						R/W	R/W
Reset	0						0	0
Bit	7	6	5	4	3	2	1	0
	PERn	PERn	PERn	PERn	PERn	PERn	PERn	PERn
Access	R/W	R/W	R/W	R/W	R/W	R/W	R/W	R/W
Reset	0	0	0	0	0	0	0	0

### Bit 15 – OVF: Overflow Interrupt Enable

Writing a '0' to this bit has no effect. Writing a '1' to this bit will set the Overflow Interrupt Enable bit, which enables the Overflow interrupt.

Value	Description
0	The Overflow interrupt is disabled.
1	The Overflow interrupt is enabled.

### Bits 9:8 – CMPn: Compare n Interrupt Enable [n = 1..0]

Writing a '0' to this bit has no effect. Writing a '1' to this bit will set the Compare n Interrupt Enable bit, which and enables the Compare n interrupt.

Value	Description
0	The Compare n interrupt is disabled.
1	The Compare n interrupt is enabled.

### Bits 7:0 – PERn: Periodic Interval n Interrupt Enable [n = 7..0]

Writing a '0' to this bit has no effect. Writing a '1' to this bit will set the Periodic Interval n Interrupt Enable bit, which enables the Periodic Interval n interrupt.

Value	Description
0	Periodic Interval n interrupt is disabled.
1	Periodic Interval n interrupt is enabled.

#### 25.10.5 Interrupt Flag Status and Clear in COUNT16 mode (CTRLA.MODE=1)

This register allows the user to enable an interrupt without doing a read-modify-write operation. Changes in this register will also be reflected in the Interrupt Enable Clear (INTENCLR) register.

**Name:** INTFLAG

**Offset:** 0x0C

**Reset:** 0x0000

**Property:** -

Bit	15	14	13	12	11	10	9	8
	OVF						CMPn	CMPn
Access	R/W						R/W	R/W
Reset	0						0	0
Bit	7	6	5	4	3	2	1	0
	PERn	PERn	PERn	PERn	PERn	PERn	PERn	PERn
Access	R/W	R/W	R/W	R/W	R/W	R/W	R/W	R/W
Reset	0	0	0	0	0	0	0	0

**Bit 15 – OVF: Overflow**

This flag is cleared by writing a '1' to the flag.

This flag is set on the next CLK\_RTC\_CNT cycle after an overflow condition occurs, and an interrupt request will be generated if INTENCLR/SET.OVF is '1'.

Writing a '0' to this bit has no effect.

Writing a '1' to this bit clears the Overflow interrupt flag.

**Bits 9:8 – CMPn: Compare n [n = 1..0]**

This flag is cleared by writing a '1' to the flag.

This flag is set on the next CLK\_RTC\_CNT cycle after a match with the compare condition, and an interrupt request will be generated if INTENCLR/SET.COMPx is one.

Writing a '0' to this bit has no effect.

Writing a '1' to this bit clears the Compare n interrupt flag.

**Bits 7:0 – PERn: Periodic Interval n [n = 7..0]**

This flag is cleared by writing a '1' to the flag.

This flag is set on the 0-to-1 transition of prescaler bit [n+2], and an interrupt request will be generated if INTENCLR/SET.PERx is one.

Writing a '0' to this bit has no effect.

Writing a '1' to this bit clears the Periodic Interval n interrupt flag.

**25.10.6 Debug Control**

**Name:** DBGCTRL  
**Offset:** 0x0E  
**Reset:** 0x00  
**Property:** PAC Write-Protection

Bit	7	6	5	4	3	2	1	0
								DBGRUN
Access								R/W
Reset								0

**Bit 0 – DBGRUN: Debug Run**

This bit is not reset by a software reset.

This bit controls the functionality when the CPU is halted by an external debugger.

Value	Description
0	The RTC is halted when the CPU is halted by an external debugger.
1	The RTC continues normal operation when the CPU is halted by an external debugger.

## 25.10.7 Synchronization Busy in COUNT16 mode (CTRLA.MODE=1)

**Name:** SYNCBUSY

**Offset:** 0x10

**Reset:** 0x00000000

**Property:** -

	Bit	31		30		29		28		27		26		25		24	
		[Bit Fields 24-31]															
Access																	
Reset																	
	Bit	23		22		21		20		19		18		17		16	
		[Bit Fields 16-23]															
Access																	
Reset																	
	Bit	15		14		13		12		11		10		9		8	
		[Bit Fields 8-15]															
Access																	
Reset																	
	Bit	7		6		5		4		3		2		1		0	
		[Bit Fields 0-7]															
Access																	
Reset																	

### Bit 15 – COUNTSYNC: Count Read Sync Enable Synchronization Busy Status

Value	Description
0	Write synchronization for CTRLA.COUNTSYNC bit is complete.
1	Write synchronization for CTRLA.COUNTSYNC bit is ongoing.

### Bits 6:5 – COMPn: Compare n Synchronization Busy Status [n = 1..0]

Value	Description
0	Write synchronization for COMPn register is complete.
1	Write synchronization for COMPn register is ongoing.

### Bit 4 – PER: Period Synchronization Busy Status

Value	Description
0	Write synchronization for PER register is complete.
1	Write synchronization for PER register is ongoing.

### Bit 3 – COUNT: Count Value Synchronization Busy Status

Value	Description
0	Read/write synchronization for COUNT register is complete.
1	Read/write synchronization for COUNT register is ongoing.

### Bit 2 – FREQCORR: Frequency Correction Synchronization Busy Status

Value	Description
0	Read/write synchronization for FREQCORR register is complete.
1	Read/write synchronization for FREQCORR register is ongoing.

### Bit 1 – ENABLE: Enable Synchronization Busy Status

Value	Description
0	Read/write synchronization for CTRLA.ENABLE bit is complete.
1	Read/write synchronization for CTRLA.ENABLE bit is ongoing.

### Bit 0 – SWRST: Software Reset Synchronization Busy Status

Value	Description
0	Read/write synchronization for CTRLA.SWRST bit is complete.
1	Read/write synchronization for CTRLA.SWRST bit is ongoing.

## 25.10.8 Frequency Correction

**Name:** FREQCORR  
**Offset:** 0x14  
**Reset:** 0x00  
**Property:** PAC Write-Protection, Write-Synchronized

Bit	7	6	5	4	3	2	1	0
	SIGN	VALUE[6:0]						
Access	R/W	R/W	R/W	R/W	R/W	R/W	R/W	R/W
Reset	0	0	0	0	0	0	0	0

### Bit 7 – SIGN: Correction Sign

Value	Description
0	The correction value is positive, i.e., frequency will be decreased.
1	The correction value is negative, i.e., frequency will be increased.

### Bits 6:0 – VALUE[6:0]: Correction Value

These bits define the amount of correction applied to the RTC prescaler.

Value	Description
0	Correction is disabled and the RTC frequency is unchanged.
1 - 127	The RTC frequency is adjusted according to the value.

## 25.10.9 Counter Value in COUNT16 mode (CTRLA.MODE=1)

**Name:** COUNT  
**Offset:** 0x18  
**Reset:** 0x0000  
**Property:** PAC Write-Protection, Write-Synchronized, Read-Synchronized

	Bit	15	14	13	12	11	10	9	8
	COUNT[15:8]								
Access	R/W	R/W	R/W	R/W	R/W	R/W	R/W	R/W	R/W
Reset	0	0	0	0	0	0	0	0	0
	Bit	7	6	5	4	3	2	1	0
	COUNT[7:0]								
Access	R/W	R/W	R/W	R/W	R/W	R/W	R/W	R/W	R/W
Reset	0	0	0	0	0	0	0	0	0

**Bits 15:0 – COUNT[15:0]: Counter Value**  
 These bits define the value of the 16-bit RTC counter in COUNT16 mode (CTRLA.MODE=1).

### 25.10.10 Counter Period in COUNT16 mode (CTRLA.MODE=1)

**Name:** PER  
**Offset:** 0x1C  
**Reset:** 0x0000  
**Property:** PAC Write-Protection, Write-Synchronized

	Bit	15	14	13	12	11	10	9	8
	PER[15:8]								
Access	R/W	R/W	R/W	R/W	R/W	R/W	R/W	R/W	R/W
Reset	0	0	0	0	0	0	0	0	0
	Bit	7	6	5	4	3	2	1	0
	PER[7:0]								
Access	R/W	R/W	R/W	R/W	R/W	R/W	R/W	R/W	R/W
Reset	0	0	0	0	0	0	0	0	0

**Bits 15:0 – PER[15:0]: Counter Period**  
 These bits define the value of the 16-bit RTC period in COUNT16 mode (CTRLA.MODE=1).

### 25.10.11 Compare n Value in COUNT16 mode (CTRLA.MODE=1)

**Name:** COMP  
**Offset:** 0x20 + n\*0x02 [n=0..1]  
**Reset:** 0x0000  
**Property:** PAC Write-Protection, Write-Synchronized

Bit	15	14	13	12	11	10	9	8
	COMP[15:8]							
Access	R/W	R/W	R/W	R/W	R/W	R/W	R/W	R/W
Reset	0	0	0	0	0	0	0	0
Bit	7	6	5	4	3	2	1	0
	COMP[7:0]							
Access	R/W	R/W	R/W	R/W	R/W	R/W	R/W	R/W
Reset	0	0	0	0	0	0	0	0

**Bits 15:0 – COMP[15:0]: Compare Value**

The 16-bit value of COMPn is continuously compared with the 16-bit COUNT value. When a match occurs, the Compare n interrupt flag in the Interrupt Flag Status and Clear register (INTFLAG.CMPn) is set on the next counter cycle.

## 25.11 Register Summary - CLOCK

Offset	Name	Bit Pos.									
0x00	CTRLA	7:0	MATCHCLR	CLKREP			MODE[1:0]	ENABLE	SWRST		
0x01		15:8	CLOCKSYNC				PRESCALER[3:0]				
0x02 ... 0x03	Reserved										
0x04	EVCTRL	7:0	PEREOn	PEREOn	PEREOn	PEREOn	PEREOn	PEREOn	PEREOn	PEREOn	
0x05		15:8	OVFEO							ALARM00	
0x06		23:16									
0x07		31:24									
0x08	INTENCLR	7:0	PERn	PERn	PERn	PERn	PERn	PERn	PERn	PERn	
0x09		15:8	OVF							ALARM0	
0x0A	INTENSET	7:0	PERn	PERn	PERn	PERn	PERn	PERn	PERn	PERn	
0x0B		15:8	OVF							ALARM0	
0x0C	INTFLAG	7:0	PERn	PERn	PERn	PERn	PERn	PERn	PERn	PERn	
0x0D		15:8	OVF							ALARM0	
0x0E	DBGCTRL	7:0								DBGRUN	
0x0F	Reserved										
0x10	SYNDBUSY	7:0			ALARM0		CLOCK	FREQCORR	ENABLE	SWRST	
0x11		15:8	CLOCKSYNC				MASK0				
0x12		23:16									
0x13		31:24									
0x14	FREQCORR	7:0	SIGN	VALUE[6:0]							
0x15 ... 0x17	Reserved										
0x18	CLOCK	7:0	MINUTE[1:0]			SECOND[5:0]					
0x19		15:8	HOUR[3:0]				MINUTE[5:2]				
0x1A		23:16	MONTH[1:0]			DAY[4:0]					HOUR[4:4]
0x1B		31:24	YEAR[5:0]							MONTH[3:2]	
0x1C ... 0x1F	Reserved										
0x20	ALARM	7:0	MINUTE[1:0]			SECOND[5:0]					
0x21		15:8	HOUR[3:0]				MINUTE[5:2]				
0x22		23:16	MONTH[1:0]			DAY[4:0]					HOUR[4:4]
0x23		31:24	YEAR[5:0]							MONTH[3:2]	
0x24	MASK	7:0							SEL[2:0]		

## 25.12 Register Description - CLOCK

This Register Description section is valid if the RTC is in Clock/Calendar mode (CTRLA.MODE=2).

Registers can be 8, 16, or 32 bits wide. Atomic 8-, 16-, and 32-bit accesses are supported. In addition, the 8-bit quarters and 16-bit halves of a 32-bit register, and the 8-bit halves of a 16-bit register can be accessed directly.

Some registers require synchronization when read and/or written. Synchronization is denoted by the "Read-Synchronized" and/or "Write-Synchronized" property in each individual register description.

Optional write-protection by the Peripheral Access Controller (PAC) is denoted by the "PAC Write-Protection" property in each individual register description.

Some registers are enable-protected, meaning they can only be written when the module is disabled. Enable-protection is denoted by the "Enable-Protected" property in each individual register description.

## 25.12.1 Control A in Clock/Calendar mode (CTRLA.MODE=2)

**Name:** CTRLA

**Offset:** 0x00

**Reset:** 0x0000

**Property:** PAC Write-Protection, Enable-Protected, Write-Synchronized

Bit	15	14	13	12	11	10	9	8
	CLOCKSYNC				PRESCALER[3:0]			
Access	R/W				R/W	R/W	R/W	R/W
Reset	0				0	0	0	0
Bit	7	6	5	4	3	2	1	0
	MATCHCLR	CLKREP			MODE[1:0]		ENABLE	SWRST
Access	R/W	R/W			R/W	R/W	R/W	R/W
Reset	0	0			0	0	0	0

### Bit 15 – CLOCKSYNC: CLOCK Read Synchronization Enable

The CLOCK register requires synchronization when reading. Disabling the synchronization will prevent reading valid values from the CLOCK register.

This bit is not enable-protected.

Value	Description
0	CLOCK read synchronization is disabled
1	CLOCK read synchronization is enabled

### Bits 11:8 – PRESCALER[3:0]: Prescaler

These bits define the prescaling factor for the RTC clock source (GCLK\_RTC) to generate the counter clock (CLK\_RTC\_CNT). Periodic events and interrupts are not available when the prescaler is off. These bits are not synchronized.

Value	Name	Description
0x0	OFF	CLK_RTC_CNT = GCLK_RTC/1
0x1	DIV1	CLK_RTC_CNT = GCLK_RTC/1
0x2	DIV2	CLK_RTC_CNT = GCLK_RTC/2
0x3	DIV4	CLK_RTC_CNT = GCLK_RTC/4
0x4	DIV8	CLK_RTC_CNT = GCLK_RTC/8
0x5	DIV16	CLK_RTC_CNT = GCLK_RTC/16
0x6	DIV32	CLK_RTC_CNT = GCLK_RTC/32
0x7	DIV64	CLK_RTC_CNT = GCLK_RTC/64
0x8	DIV128	CLK_RTC_CNT = GCLK_RTC/128
0x9	DIV256	CLK_RTC_CNT = GCLK_RTC/256



Value	Name	Description
0xA	DIV512	CLK_RTC_CNT = GCLK_RTC/512
0xB	DIV1024	CLK_RTC_CNT = GCLK_RTC/1024
0xC-0xF	-	Reserved

### Bit 7 – MATCHCLR: Clear on Match

This bit is valid only in Mode 0 (COUNT32) and Mode 2 (CLOCK). This bit can be written only when the peripheral is disabled. This bit is not synchronized.

Value	Description
0	The counter is not cleared on a Compare/Alarm 0 match
1	The counter is cleared on a Compare/Alarm 0 match

### Bit 6 – CLKREP: Clock Representation

This bit is valid only in Mode 2 and determines how the hours are represented in the Clock Value (CLOCK) register. This bit can be written only when the peripheral is disabled. This bit is not synchronized.

Value	Description
0	24 Hour
1	12 Hour (AM/PM)

### Bits 3:2 – MODE[1:0]: Operating Mode

This field defines the operating mode of the RTC. This bit is not synchronized.

Value	Name	Description
0x0	COUNT32	Mode 0: 32-bit counter
0x1	COUNT16	Mode 1: 16-bit counter
0x2	CLOCK	Mode 2: Clock/calendar
0x3	-	Reserved

### Bit 1 – ENABLE: Enable

Due to synchronization there is delay from writing CTRLA.ENABLE until the peripheral is enabled/disabled. The value written to CTRLA.ENABLE will read back immediately and the Enable bit in the Synchronization Busy register (SYNCBUSY.ENABLE) will be set. SYNCBUSY.ENABLE will be cleared when the operation is complete.

Value	Description
0	The peripheral is disabled
1	The peripheral is enabled

### Bit 0 – SWRST: Software Reset

Writing a '0' to this bit has no effect.

Writing a '1' to this bit resets all registers in the RTC, except DBGCTRL, to their initial state, and the RTC will be disabled.

Writing a '1' to CTRLA.SWRST will always take precedence, meaning that all other writes in the same write-operation will be discarded.

Due to synchronization there is a delay from writing CTRLA.SWRST until the reset is complete. CTRLA.SWRST will be cleared when the reset is complete.

Value	Description
0	There is not reset operation ongoing
1	The reset operation is ongoing

## 25.12.2 Event Control in Clock/Calendar mode (CTRLA.MODE=2)

**Name:** EVCTRL

**Offset:** 0x04

**Reset:** 0x00000000

**Property:** PAC Write-Protection, Enable-Protected

Bit	31	30	29	28	27	26	25	24
	[Bit Fields]							
Access								
Reset								
Bit	23	22	21	20	19	18	17	16
	[Bit Fields]							
Access								
Reset								
Bit	15	14	13	12	11	10	9	8
	OVFEO							ALARM00
Access	R/W							R/W
Reset	0							0
Bit	7	6	5	4	3	2	1	0
	PEREOn	PEREOn	PEREOn	PEREOn	PEREOn	PEREOn	PEREOn	PEREOn
Access	R/W	R/W	R/W	R/W	R/W	R/W	R/W	R/W
Reset	0	0	0	0	0	0	0	0

### Bit 15 – OVFEO: Overflow Event Output Enable

Value	Description
0	Overflow event is disabled and will not be generated.
1	Overflow event is enabled and will be generated for every overflow.

### Bit 8 – ALARM00: Alarm 0 Event Output Enable

Value	Description
0	Alarm 0 event is disabled and will not be generated.
1	Alarm 0 event is enabled and will be generated for every compare match.

### Bits 7:0 – PEREOn: Periodic Interval n Event Output Enable [n = 7..0]

Value	Description
0	Periodic Interval n event is disabled and will not be generated.
1	Periodic Interval n event is enabled and will be generated.

## 25.12.3 Interrupt Enable Clear in Clock/Calendar mode (CTRLA.MODE=2)

This register allows the user to disable an interrupt without doing a read-modify-write operation. Changes in this register will also be reflected in the Interrupt Enable Set (INTENSET) register.

**Name:** INTENCLR

**Offset:** 0x08

**Reset:** 0x0000

**Property:** PAC Write-Protection

Bit	15	14	13	12	11	10	9	8
	OVF							ALARM0
Access	R/W							R/W
Reset	0							0
Bit	7	6	5	4	3	2	1	0
	PERn	PERn	PERn	PERn	PERn	PERn	PERn	PERn
Access	R/W	R/W	R/W	R/W	R/W	R/W	R/W	R/W
Reset	0	0	0	0	0	0	0	0

### Bit 15 – OVF: Overflow Interrupt Enable

Writing a '0' to this bit has no effect. Writing a '1' to this bit will clear the Overflow Interrupt Enable bit, which disables the Overflow interrupt.

Value	Description
0	The Overflow interrupt is disabled.
1	The Overflow interrupt is enabled.

### Bit 8 – ALARM0: Alarm 0 Interrupt Enable

Writing a '0' to this bit has no effect. Writing a '1' to this bit will clear the Alarm 0 Interrupt Enable bit, which disables the Alarm interrupt.

Value	Description
0	The Alarm 0 interrupt is disabled.
1	The Alarm 0 interrupt is enabled.

### Bits 7:0 – PERn: Periodic Interval n Interrupt Enable [n = 7..0]

Writing a '0' to this bit has no effect. Writing a '1' to this bit will clear the Periodic Interval n Interrupt Enable bit, which disables the Periodic Interval n interrupt.

Value	Description
0	Periodic Interval n interrupt is disabled.
1	Periodic Interval n interrupt is enabled.

## 25.12.4 Interrupt Enable Set in Clock/Calendar mode (CTRLA.MODE=2)

This register allows the user to enable an interrupt without doing a read-modify-write operation. Changes in this register will also be reflected in the Interrupt Enable Clear (INTENCLR) register.

**Name:** INTENSET  
**Offset:** 0x0A  
**Reset:** 0x0000  
**Property:** PAC Write-Protection

Bit	15	14	13	12	11	10	9	8
	OVF							ALARM0
Access	R/W							R/W
Reset	0							0
Bit	7	6	5	4	3	2	1	0
	PERn	PERn	PERn	PERn	PERn	PERn	PERn	PERn
Access	R/W	R/W	R/W	R/W	R/W	R/W	R/W	R/W
Reset	0	0	0	0	0	0	0	0

### Bit 15 – OVF: Overflow Interrupt Enable

Writing a '0' to this bit has no effect. Writing a '1' to this bit will set the Overflow Interrupt Enable bit, which enables the Overflow interrupt.

Value	Description
0	The Overflow interrupt is disabled.
1	The Overflow interrupt is enabled.

### Bit 8 – ALARM0: Alarm 0 Interrupt Enable

Writing a '0' to this bit has no effect. Writing a '1' to this bit will set the Alarm 0 Interrupt Enable bit, which enables the Alarm 0 interrupt.

Value	Description
0	The Alarm 0 interrupt is disabled.
1	The Alarm 0 interrupt is enabled.

### Bits 7:0 – PERn: Periodic Interval n Interrupt Enable [n = 7..0]

Writing a '0' to this bit has no effect. Writing a '1' to this bit will set the Periodic Interval n Interrupt Enable bit, which enables the Periodic Interval n interrupt.

Value	Description
0	Periodic Interval n interrupt is disabled.
1	Periodic Interval n interrupt is enabled.

#### 25.12.5 Interrupt Flag Status and Clear in Clock/Calendar mode (CTRLA.MODE=2)

This register allows the user to enable an interrupt without doing a read-modify-write operation. Changes in this register will also be reflected in the Interrupt Enable Clear (INTENCLR) register.

**Name:** INTFLAG  
**Offset:** 0x0C  
**Reset:** 0x0000  
**Property:** -

Bit	15	14	13	12	11	10	9	8
	OVF							ALARM0
Access	R/W							R/W
Reset	0							0
Bit	7	6	5	4	3	2	1	0
	PERn	PERn	PERn	PERn	PERn	PERn	PERn	PERn
Access	R/W	R/W	R/W	R/W	R/W	R/W	R/W	R/W
Reset	0	0	0	0	0	0	0	0

**Bit 15 – OVF: Overflow**

This flag is cleared by writing a '1' to the flag.

This flag is set on the next CLK\_RTC\_CNT cycle after an overflow condition occurs, and an interrupt request will be generated if INTENCLR/SET.OVF is '1'.

Writing a '0' to this bit has no effect.

Writing a '1' to this bit clears the Overflow interrupt flag.

**Bit 8 – ALARM0: Alarm 0**

This flag is cleared by writing a '1' to the flag.

This flag is set on the next CLK\_RTC\_CNT cycle after a match with the compare condition, and an interrupt request will be generated if INTENCLR/SET.ALARM0 is one.

Writing a '0' to this bit has no effect.

Writing a '1' to this bit clears the Alarm 0 interrupt flag.

**Bits 7:0 – PERn: Periodic Interval n [n = 7..0]**

This flag is cleared by writing a '1' to the flag.

This flag is set on the 0-to-1 transition of prescaler bit [n+2], and an interrupt request will be generated if INTENCLR/SET.PERx is '1'.

Writing a '0' to this bit has no effect.

Writing a '1' to this bit clears the Periodic Interval n interrupt flag.

**25.12.6 Debug Control**

**Name:** DBGCTRL  
**Offset:** 0x0E  
**Reset:** 0x00  
**Property:** PAC Write-Protection

Bit	7	6	5	4	3	2	1	0
								DBGRUN
Access								R/W
Reset								0

**Bit 0 – DBGRUN: Debug Run**

This bit is not reset by a software reset.

This bit controls the functionality when the CPU is halted by an external debugger.

Value	Description
0	The RTC is halted when the CPU is halted by an external debugger.
1	The RTC continues normal operation when the CPU is halted by an external debugger.

## 25.12.7 Synchronization Busy in Clock/Calendar mode (CTRLA.MODE=2)

**Name:** SYNCBUSY

**Offset:** 0x10

**Reset:** 0x00000000

**Property:** -



### Bit 15 – CLOCKSYNC: Clock Read Sync Enable Synchronization Busy Status

Value	Description
0	Write synchronization for CTRLA.CLOCKSYNC bit is complete.
1	Write synchronization for CTRLA.CLOCKSYNC bit is ongoing.

### Bit 11 – MASK0: Mask 0 Synchronization Busy Status

Value	Description
0	Write synchronization for MASK0 register is complete.
1	Write synchronization for MASK0 register is ongoing.

### Bit 5 – ALARM0: Alarm 0 Synchronization Busy Status

Value	Description
0	Write synchronization for ALARM0 register is complete.
1	Write synchronization for ALARM0 register is ongoing.

### Bit 3 – CLOCK: Clock Register Synchronization Busy Status

Value	Description
0	Read/write synchronization for CLOCK register is complete.
1	Read/write synchronization for CLOCK register is ongoing.

### Bit 2 – FREQCORR: Frequency Correction Synchronization Busy Status

Value	Description
0	Read/write synchronization for FREQCORR register is complete.
1	Read/write synchronization for FREQCORR register is ongoing.

### Bit 1 – ENABLE: Enable Synchronization Busy Status

Value	Description
0	Read/write synchronization for CTRLA.ENABLE bit is complete.
1	Read/write synchronization for CTRLA.ENABLE bit is ongoing.

### Bit 0 – SWRST: Software Reset Synchronization Busy Status

Value	Description
0	Read/write synchronization for CTRLA.SWRST bit is complete.
1	Read/write synchronization for CTRLA.SWRST bit is ongoing.

## 25.12.8 Frequency Correction

**Name:** FREQCORR  
**Offset:** 0x14  
**Reset:** 0x00  
**Property:** PAC Write-Protection, Write-Synchronized

Bit	7	6	5	4	3	2	1	0
	SIGN	VALUE[6:0]						
Access	R/W	R/W	R/W	R/W	R/W	R/W	R/W	R/W
Reset	0	0	0	0	0	0	0	0

### Bit 7 – SIGN: Correction Sign

Value	Description
0	The correction value is positive, i.e., frequency will be decreased.
1	The correction value is negative, i.e., frequency will be increased.

### Bits 6:0 – VALUE[6:0]: Correction Value

These bits define the amount of correction applied to the RTC prescaler.

Value	Description
0	Correction is disabled and the RTC frequency is unchanged.
1 - 127	The RTC frequency is adjusted according to the value.

## 25.12.9 Clock Value in Clock/Calendar mode (CTRLA.MODE=2)

**Name:** CLOCK  
**Offset:** 0x18  
**Reset:** 0x00000000  
**Property:** PAC Write-Protection, Write-Synchronized, Read-Synchronized

	Bit	31	30	29	28	27	26	25	24	
		YEAR[5:0]						MONTH[3:2]		
Access		R/W	R/W	R/W	R/W	R/W	R/W	R/W	R/W	
Reset		0	0	0	0	0	0	0	0	
	Bit	23	22	21	20	19	18	17	16	
		MONTH[1:0]			DAY[4:0]				HOUR[4:4]	
Access		R/W	R/W	R/W	R/W	R/W	R/W	R/W	R/W	
Reset		0	0	0	0	0	0	0	0	
	Bit	15	14	13	12	11	10	9	8	
		HOUR[3:0]				MINUTE[5:2]				
Access		R/W	R/W	R/W	R/W	R/W	R/W	R/W	R/W	
Reset		0	0	0	0	0	0	0	0	
	Bit	7	6	5	4	3	2	1	0	
		MINUTE[1:0]			SECOND[5:0]					
Access		R/W	R/W	R/W	R/W	R/W	R/W	R/W	R/W	
Reset		0	0	0	0	0	0	0	0	

**Bits 31:26 – YEAR[5:0]: Year**

The year offset with respect to the reference year (defined in software).

The year is considered a leap year if YEAR[1:0] is zero.

**Bits 25:22 – MONTH[3:0]: Month**

1 – January

2 – February

...

12 – December

**Bits 21:17 – DAY[4:0]: Day**

Day starts at 1 and ends at 28, 29, 30, or 31, depending on the month and year.

**Bits 16:12 – HOUR[4:0]: Hour**

When CTRLA.CLKREP=0, the Hour bit group is in 24-hour format, with values 0-23. When CTRLA.CLKREP=1, HOUR[3:0] has values 1-12, and HOUR[4] represents AM (0) or PM (1).

**Bits 11:6 – MINUTE[5:0]: Minute**

0 – 59

**Bits 5:0 – SECOND[5:0]: Second**

0 – 59



## 25.12.10 Alarm Value in Clock/Calendar mode (CTRLA.MODE=2)

The 32-bit value of ALARM is continuously compared with the 32-bit CLOCK value, based on the masking set by MASK.SEL. When a match occurs, the Alarm n interrupt flag in the Interrupt Flag Status and Clear register (INTFLAG.ALARM) is set on the next counter cycle, and the counter is cleared if CTRLA.MATCHCLR is '1'.

**Name:** ALARM

**Offset:** 0x20

**Reset:** 0x00000000

**Property:** PAC Write-Protection, Write-Synchronized

	Bit	31	30	29	28	27	26	25	24	
		YEAR[5:0]					MONTH[3:2]			
Access		R/W	R/W	R/W	R/W	R/W	R/W	R/W	R/W	
Reset		0	0	0	0	0	0	0	0	
	Bit	23	22	21	20	19	18	17	16	
		MONTH[1:0]			DAY[4:0]				HOUR[4:4]	
Access		R/W	R/W	R/W	R/W	R/W	R/W	R/W	R/W	
Reset		0	0	0	0	0	0	0	0	
	Bit	15	14	13	12	11	10	9	8	
		HOUR[3:0]				MINUTE[5:2]				
Access		R/W	R/W	R/W	R/W	R/W	R/W	R/W	R/W	
Reset		0	0	0	0	0	0	0	0	
	Bit	7	6	5	4	3	2	1	0	
		MINUTE[1:0]		SECOND[5:0]						
Access		R/W	R/W	R/W	R/W	R/W	R/W	R/W	R/W	
Reset		0	0	0	0	0	0	0	0	

**Bits 31:26 – YEAR[5:0]: Year**

The alarm year. Years are only matched if MASK.SEL is 6

**Bits 25:22 – MONTH[3:0]: Month**

The alarm month. Months are matched only if MASK.SEL is greater than 4.

**Bits 21:17 – DAY[4:0]: Day**

The alarm day. Days are matched only if MASK.SEL is greater than 3.

**Bits 16:12 – HOUR[4:0]: Hour**

The alarm hour. Hours are matched only if MASK.SEL is greater than 2.

**Bits 11:6 – MINUTE[5:0]: Minute**

The alarm minute. Minutes are matched only if MASK.SEL is greater than 1.

**Bits 5:0 – SECOND[5:0]: Second**

The alarm second. Seconds are matched only if MASK.SEL is greater than 0.

## 25.12.11 Alarm Mask in Clock/Calendar mode (CTRLA.MODE=2)

**Name:** MASK  
**Offset:** 0x24  
**Reset:** 0x00  
**Property:** PAC Write-Protection, Write-Synchronized

Bit	7	6	5	4	3	2	1	0
						SEL[2:0]		
Access						R/W	R/W	R/W
Reset						0	0	0

**Bits 2:0 – SEL[2:0]: Alarm Mask Selection**

These bits define which bit groups of ALARM are valid.

Value	Name	Description
0x0	OFF	Alarm Disabled
0x1	SS	Match seconds only
0x2	MMSS	Match seconds and minutes only
0x3	HHMMSS	Match seconds, minutes, and hours only
0x4	DDHHMMSS	Match seconds, minutes, hours, and days only
0x5	MMDDHHMMSS	Match seconds, minutes, hours, days, and months only
0x6	YYMMDDHHMMSS	Match seconds, minutes, hours, days, months, and years
0x7	-	Reserved

## 26. DMAC – Direct Memory Access Controller

### 26.1 Overview

The Direct Memory Access Controller (DMAC) contains both a Direct Memory Access engine and a Cyclic Redundancy Check (CRC) engine. The DMAC can transfer data between memories and peripherals, and thus off-load these tasks from the CPU. It enables high data transfer rates with minimum CPU intervention, and frees up CPU time. With access to all peripherals, the DMAC can handle automatic transfer of data between communication modules.

The DMA part of the DMAC has several DMA channels which all can receive different types of transfer triggers to generate transfer requests from the DMA channels to the arbiter, see also the [Block Diagram](#). The arbiter will grant one DMA channel at a time to act as the active channel. When an active channel has been granted, the fetch engine of the DMAC will fetch a transfer descriptor from the SRAM and store it in the internal memory of the active channel, which will execute the data transmission.

An ongoing data transfer of an active channel can be interrupted by a higher prioritized DMA channel. The DMAC will write back the updated transfer descriptor from the internal memory of the active channel to SRAM, and grant the higher prioritized channel to start transfer as the new active channel. Once a DMA channel is done with its transfer, interrupts and events can be generated optionally.

The DMAC has four bus interfaces:

- The *data transfer bus* is used for performing the actual DMA transfer.
- The *AHB/APB Bridge bus* is used when writing and reading the I/O registers of the DMAC.
- The *descriptor fetch bus* is used by the fetch engine to fetch transfer descriptors before data transfer can be started or continued.
- The *write-back bus* is used to write the transfer descriptor back to SRAM.

All buses are AHB master interfaces but the AHB/APB Bridge bus, which is an APB slave interface.

The CRC engine can be used by software to detect an accidental error in the transferred data and to take corrective action, such as requesting the data to be sent again or simply not using the incorrect data.

### 26.2 Features

- Data transfer from:
  - Peripheral to peripheral
  - Peripheral to memory
  - Memory to peripheral
  - Memory to memory
- Transfer trigger sources
  - Software
  - Events from Event System
  - Dedicated requests from peripherals
- SRAM based transfer descriptors
  - Single transfer using one descriptor
  - Multi-buffer or circular buffer modes by linking multiple descriptors
- Up to 6 channels

- Enable 6 independent transfers
  - Automatic descriptor fetch for each channel
  - Suspend/resume operation support for each channel
- Flexible arbitration scheme
  - 4 configurable priority levels for each channel
  - Fixed or round-robin priority scheme within each priority level
- From 1 to 256KB data transfer in a single block transfer
- Multiple addressing modes
  - Static
  - Configurable increment scheme
- Optional interrupt generation
  - On block transfer complete
  - On error detection
  - On channel suspend
- 4 event inputs
  - One event input for each of the 4 least significant DMA channels
  - Can be selected to trigger normal transfers, periodic transfers or conditional transfers
  - Can be selected to suspend or resume channel operation
- 4 event outputs
  - One output event for each of the 4 least significant DMA channels
  - Selectable generation on AHB, block, or transaction transfer complete
- Error management supported by write-back function
  - Dedicated Write-Back memory section for each channel to store ongoing descriptor transfer
- CRC polynomial software selectable to
  - CRC-16 (CRC-CCITT)
  - CRC-32 (IEEE<sup>®</sup> 802.3)

26.3 Block Diagram

Figure 26-1. DMAC Block Diagram



26.4 Signal Description

Not applicable.

26.5 Product Dependencies

In order to use this peripheral, other parts of the system must be configured correctly, as described below.

26.5.1 I/O Lines

Not applicable.

26.5.2 Power Management

The DMAC will continue to operate in any sleep mode where the selected source clock is running. The DMAC's interrupts can be used to wake up the device from sleep modes. Events connected to the event system can trigger other operations in the system without exiting sleep modes. On hardware or software reset, all registers are set to their reset value.

Related Links

[PM – Power Manager](#)

26.5.3 Clocks

The DMAC bus clock (CLK\_DMACH\_APB) must be configured and enabled in the Main Clock module before using the DMAC.

This bus clock (CLK\_DMACH\_APB) is always synchronous to the module clock (CLK\_DMACH\_AHB), but can be divided by a prescaler and may run even when the module clock is turned off.

#### Related Links

[Peripheral Clock Masking](#)

#### 26.5.4 DMA

Not applicable.

#### 26.5.5 Interrupts

The interrupt request line is connected to the interrupt controller. Using the DMACH interrupt requires the interrupt controller to be configured first.

#### Related Links

[Nested Vector Interrupt Controller](#)

#### 26.5.6 Events

The events are connected to the event system.

#### Related Links

[EVSYS – Event System](#)

#### 26.5.7 Debug Operation

When the CPU is halted in debug mode the DMACH will halt normal operation. The DMACH can be forced to continue operation during debugging. Refer to [DBGCTRL](#) for details.

#### 26.5.8 Register Access Protection

All registers with write-access can be write-protected optionally by the Peripheral Access Controller (PAC), except for the following registers:

- Interrupt Pending register (INTPEND)
- Channel ID register (CHID)
- Channel Interrupt Flag Status and Clear register (CHINTFLAG)

Optional write-protection by the Peripheral Access Controller (PAC) is denoted by the "PAC Write-Protection" property in each individual register description.

PAC write-protection does not apply to accesses through an external debugger.

#### Related Links

[PAC - Peripheral Access Controller](#)

#### 26.5.9 Analog Connections

Not applicable.

## 26.6 Functional Description

### 26.6.1 Principle of Operation

The DMACH consists of a DMA module and a CRC module.

#### 26.6.1.1 DMA

The DMACH can transfer data between memories and peripherals without interaction from the CPU. The data transferred by the DMACH are called transactions, and these transactions can be split into smaller data transfers. Figure 'DMA Transfer Sizes' shows the relationship between the different transfer sizes:

**Figure 26-2. DMA Transfer Sizes**



- Beat transfer: The size of one data transfer bus access, and the size is selected by writing the Beat Size bit group in the Block Transfer Control register (BTCTRL.BEATSIZE)
- Block transfer: The amount of data one transfer descriptor can transfer, and the amount can range from 1 to 64k beats. A block transfer can be interrupted.
- Transaction: The DMAC can link several transfer descriptors by having the first descriptor pointing to the second and so forth, as shown in the figure above. A DMA transaction is the complete transfer of all blocks within a linked list.

A transfer descriptor describes how a block transfer should be carried out by the DMAC, and it must remain in SRAM. For further details on the transfer descriptor refer to [Transfer Descriptors](#).

The figure above shows several block transfers linked together, which are called linked descriptors. For further information about linked descriptors, refer to [Linked Descriptors](#).

A DMA transfer is initiated by an incoming transfer trigger on one of the DMA channels. This trigger can be configured to be either a software trigger, an event trigger, or one of the dedicated peripheral triggers. The transfer trigger will result in a DMA transfer request from the specific channel to the arbiter. If there are several DMA channels with pending transfer requests, the arbiter chooses which channel is granted access to become the active channel. The DMA channel granted access as the active channel will carry out the transaction as configured in the transfer descriptor. A current transaction can be interrupted by a higher prioritized channel, but will resume the block transfer when the according DMA channel is granted access as the active channel again.

For each beat transfer, an optional output event can be generated. For each block transfer, optional interrupts and an optional output event can be generated. When a transaction is completed, dependent of the configuration, the DMA channel will either be suspended or disabled.

## 26.6.1.2 CRC

The internal CRC engine supports two commonly used CRC polynomials: CRC-16 (CRC-CCITT) and CRC-32 (IEEE 802.3). It can be used on a selectable DMA channel, or on the I/O interface. Refer to [CRC Operation](#) for details.

## 26.6.2 Basic Operation

### 26.6.2.1 Initialization

The following DMAC registers are enable-protected, meaning that they can only be written when the DMAC is disabled (CTRL.DMAENABLE=0):

- Descriptor Base Memory Address register (BASEADDR)
- Write-Back Memory Base Address register (WRBADDR)

The following DMAC bit is enable-protected, meaning that it can only be written when both the DMAC and CRC are disabled (CTRL.DMAENABLE=0 and CTRL.CRCENABLE=0):

- Software Reset bit in Control register (CTRL.SWRST)

The following DMA channel register is enable-protected, meaning that it can only be written when the corresponding DMA channel is disabled (CHCTRLA.ENABLE=0):

- Channel Control B (CHCTRLB) register, except the Command bit (CHCTRLB.CMD) and the Channel Arbitration Level bit (CHCTRLB.LVL)

The following DMA channel bit is enable-protected, meaning that it can only be written when the corresponding DMA channel is disabled:

- Channel Software Reset bit in Channel Control A register (CHCTRLA.SWRST)

The following CRC registers are enable-protected, meaning that they can only be written when the CRC is disabled (CTRL.CRCENABLE=0):

- CRC Control register (CRCCTRL)
- CRC Checksum register (CRCCHKSUM)

Enable-protection is denoted by the "Enable-Protected" property in the register description.

Before the DMAC is enabled it must be configured, as outlined by the following steps:

- The SRAM address of where the descriptor memory section is located must be written to the Description Base Address (BASEADDR) register
- The SRAM address of where the write-back section should be located must be written to the Write-Back Memory Base Address (WRBADDR) register
- Priority level x of the arbiter can be enabled by setting the Priority Level x Enable bit in the Control register (CTRL.LVLENx=1)

Before a DMA channel is enabled, the DMA channel and the corresponding first transfer descriptor must be configured, as outlined by the following steps:

- DMA channel configurations
  - The channel number of the DMA channel to configure must be written to the Channel ID (CHID) register
  - Trigger action must be selected by writing the Trigger Action bit group in the Channel Control B register (CHCTRLB.TRIGACT)
  - Trigger source must be selected by writing the Trigger Source bit group in the Channel Control B register (CHCTRLB.TRIGSRC)
- Transfer Descriptor
  - The size of each access of the data transfer bus must be selected by writing the Beat Size bit group in the Block Transfer Control register (BTCTRL.BEATSIZE)
  - The transfer descriptor must be made valid by writing a one to the Valid bit in the Block Transfer Control register (BTCTRL.VALID)
  - Number of beats in the block transfer must be selected by writing the Block Transfer Count (BTCNT) register
  - Source address for the block transfer must be selected by writing the Block Transfer Source Address (SRCADDR) register
  - Destination address for the block transfer must be selected by writing the Block Transfer Destination Address (DSTADDR) register

If CRC calculation is needed, the CRC engine must be configured before it is enabled, as outlined by the following steps:

- The CRC input source must be selected by writing the CRC Input Source bit group in the CRC Control register (CRCCTRL.CRCSRC)



- The type of CRC calculation must be selected by writing the CRC Polynomial Type bit group in the CRC Control register (CRCCTRL.CRCPOLY)
- If I/O is selected as input source, the beat size must be selected by writing the CRC Beat Size bit group in the CRC Control register (CRCCTRL.CRCBEATSIZE)

## Related Links

[BASEADDR](#)

[CHCTRLA](#)

[CHCTRLB](#)

[CRCCHKSUM](#)

[CRCCTRL](#)

[CTRL](#)

[WRBADDR](#)

[BTCTRL](#)

[BTCNT](#)

[DSTADDR](#)

[SRCADDR](#)

### 26.6.2.2 Enabling, Disabling, and Resetting

The DMAC is enabled by writing the DMA Enable bit in the Control register (CTRL.DMAENABLE) to '1'. The DMAC is disabled by writing a '0' to CTRL.DMAENABLE.

A DMA channel is enabled by writing the Enable bit in the Channel Control A register (CHCTRLA.ENABLE) to '1', after writing the corresponding channel id to the Channel ID bit group in the Channel ID register (CHID.ID). A DMA channel is disabled by writing a '0' to CHCTRLA.ENABLE.

The CRC is enabled by writing a '1' to the CRC Enable bit in the Control register (CTRL.CRCENABLE). The CRC is disabled by writing a '0' to CTRL.CRCENABLE.

The DMAC is reset by writing a '1' to the Software Reset bit in the Control register (CTRL.SWRST) while the DMAC and CRC are disabled. All registers in the DMAC except DBGCTRL will be reset to their initial state.

A DMA channel is reset by writing a '1' to the Software Reset bit in the Channel Control A register (CHCTRLA.SWRST), after writing the corresponding channel id to the Channel ID bit group in the Channel ID register (CHID.ID). The channel registers will be reset to their initial state. The corresponding DMA channel must be disabled in order for the reset to take effect.

### 26.6.2.3 Transfer Descriptors

Together with the channel configurations the transfer descriptors decides how a block transfer should be executed. Before a DMA channel is enabled (CHCTRLA.ENABLE is written to one), and receives a transfer trigger, its first transfer descriptor has to be initialized and valid (BTCTRL.VALID). The first transfer descriptor describes the first block transfer of a transaction.

All transfer descriptors must reside in SRAM. The addresses stored in the Descriptor Memory Section Base Address (BASEADDR) and Write-Back Memory Section Base Address (WRBADDR) registers tell the DMAC where to find the descriptor memory section and the write-back memory section.

The descriptor memory section is where the DMAC expects to find the first transfer descriptors for all DMA channels. As BASEADDR points only to the first transfer descriptor of channel 0 (see figure below), all first transfer descriptors must be stored in a contiguous memory section, where the transfer descriptors must be ordered according to their channel number. For further details on linked descriptors, refer to [Linked Descriptors](#).

The write-back memory section is the section where the DMAC stores the transfer descriptors for the ongoing block transfers. WRBADDR points to the ongoing transfer descriptor of channel 0. All ongoing transfer descriptors will be stored in a contiguous memory section where the transfer descriptors are ordered according to their channel number. The figure below shows an example of linked descriptors on DMA channel 0. For further details on linked descriptors, refer to [Linked Descriptors](#).

**Figure 26-3. Memory Sections**



The size of the descriptor and write-back memory sections is dependent on the number of the most significant enabled DMA channel  $m$ , as shown below:

$$Size = 128\text{bits} \cdot (m + 1)$$

For memory optimization, it is recommended to always use the less significant DMA channels if not all channels are required.

The descriptor and write-back memory sections can either be two separate memory sections, or they can share memory section (BASEADDR=WRBADDR). The benefit of having them in two separate sections, is that the same transaction for a channel can be repeated without having to modify the first transfer descriptor. The benefit of having descriptor memory and write-back memory in the same section is that it requires less SRAM.

#### 26.6.2.4 Arbitration

If a DMA channel is enabled and not suspended when it receives a transfer trigger, it will send a transfer request to the arbiter. When the arbiter receives the transfer request it will include the DMA channel in the

queue of channels having pending transfers, and the corresponding Pending Channel x bit in the Pending Channels registers (`PENDCH.PENDCHx`) will be set. Depending on the arbitration scheme, the arbiter will choose which DMA channel will be the next active channel. The active channel is the DMA channel being granted access to perform its next transfer. When the arbiter has granted a DMA channel access to the DMAC, the corresponding bit `PENDCH.PENDCHx` will be cleared. See also the following figure.

If the upcoming transfer is the first for the transfer request, the corresponding Busy Channel x bit in the Busy Channels register will be set (`BUSYCH.BUSYCHx=1`), and it will remain '1' for the subsequent granted transfers.

When the channel has performed its granted transfer(s) it will be either fed into the queue of channels with pending transfers, set to be waiting for a new transfer trigger, suspended, or disabled. This depends on the channel and block transfer configuration. If the DMA channel is fed into the queue of channels with pending transfers, the corresponding `BUSYCH.BUSYCHx` will remain '1'. If the DMA channel is set to wait for a new transfer trigger, suspended, or disabled, the corresponding `BUSYCH.BUSYCHx` will be cleared.

If a DMA channel is suspended while it has a pending transfer, it will be removed from the queue of pending channels, but the corresponding `PENDCH.PENDCHx` will remain set. When the same DMA channel is resumed, it will be added to the queue of pending channels again.

If a DMA channel gets disabled (`CHCTRLA.ENABLE=0`) while it has a pending transfer, it will be removed from the queue of pending channels, and the corresponding `PENDCH.PENDCHx` will be cleared.

**Figure 26-4. Arbiter Overview**



## Priority Levels

When a channel level is pending or the channel is transferring data, the corresponding Level Executing bit is set in the Active Channel and Levels register (`ACTIVE.LVLEXx`).

Each DMA channel supports a 4-level priority scheme. The priority level for a channel is configured by writing to the Channel Arbitration Level bit group in the Channel Control B register (`CHCTRLB.LVL`). As long as all priority levels are enabled, a channel with a higher priority level number will have priority over a channel with a lower priority level number. Each priority level x is enabled by setting the corresponding Priority Level x Enable bit in the Control register (`CTRL.LVLENx=1`).

Within each priority level the DMAC's arbiter can be configured to prioritize statically or dynamically:

*Static Arbitration* within a priority level is selected by writing a '0' to the Level x Round-Robin Scheduling Enable bit in the Priority Control 0 register (`PRICTRL0.RRLVLENx`).

When static arbitration is selected, the arbiter will prioritize a low channel number over a high channel number as shown in the figure below. When using the static arbitration there is a risk of high channel numbers never being granted access as the active channel. This can be avoided using a dynamic arbitration scheme.

**Figure 26-5. Static Priority Scheduling**



*Dynamic Arbitration* within a priority level is selected by writing a '1' to `PRICTRL0.RRLVLENx`.

The dynamic arbitration scheme in the DMAC is round-robin. With the round-robin scheme, the channel number of the last channel being granted access will have the lowest priority the next time the arbiter has to grant access to a channel within the same priority level, as shown in [Figure 26-6](#). The channel number of the last channel being granted access as the active channel is stored in the Level x Channel Priority Number bit group in the Priority Control 0 register (`PRICTRL0.LVLPRIx`) for the corresponding priority level.

**Figure 26-6. Dynamic (Round-Robin) Priority Scheduling**



### 26.6.2.5 Data Transmission

Before the DMAC can perform a data transmission, a DMA channel has to be configured and enabled, its corresponding transfer descriptor has to be initialized, and the arbiter has to grant the DMA channel access as the active channel.

Once the arbiter has granted a DMA channel access as the active channel (refer to DMA Block Diagram section) the transfer descriptor for the DMA channel will be fetched from SRAM using the fetch bus, and stored in the internal memory for the active channel. For a new block transfer, the transfer descriptor will be fetched from the descriptor memory section ([BASEADDR](#)); For an ongoing block transfer, the descriptor will be fetched from the write-back memory section ([WRBADDR](#)). By using the data transfer bus, the DMAC will read the data from the current source address and write it to the current destination address. For further details on how the current source and destination addresses are calculated, refer to the section on [Addressing](#).

The arbitration procedure is performed after each transfer. If the current DMA channel is granted access again, the block transfer counter ([BTCNT](#)) of the internal transfer descriptor will be decremented by the number of beats in a transfer, the optional output event Beat will be generated if configured and enabled, and the active channel will perform a new transfer. If a different DMA channel than the current active channel is granted access, the block transfer counter value will be written to the write-back section before the transfer descriptor of the newly granted DMA channel is fetched into the internal memory of the active channel.

When a block transfer has come to its end ([BTCNT](#) is zero), the Valid bit in the Block Transfer Control register will be cleared ([BTCTRL.VALID=0](#)) before the entire transfer descriptor is written to the write-back memory. The optional interrupts, Channel Transfer Complete and Channel Suspend, and the optional output event Block, will be generated if configured and enabled. After the last block transfer in a transaction, the Next Descriptor Address register ([DESCADDR](#)) will hold the value 0x00000000, and the DMA channel will either be suspended or disabled, depending on the configuration in the Block Action bit group in the Block Transfer Control register ([BTCTRL.BLOCKACT](#)). If the transaction has further block transfers pending, [DESCADDR](#) will hold the SRAM address to the next transfer descriptor to be fetched. The DMAC will fetch the next descriptor into the internal memory of the active channel and write its content to the write-back section for the channel, before the arbiter gets to choose the next active channel.

### 26.6.2.6 Transfer Triggers and Actions

A DMA transfer through a DMA channel can be started only when a DMA transfer request is detected, and the DMA channel has been granted access to the DMA. A transfer request can be triggered from software, from a peripheral, or from an event. There are dedicated Trigger Source selections for each DMA Channel Control B ([CHCTRLB.TRIGSRC](#)).

The trigger actions are available in the Trigger Action bit group in the Channel Control B register ([CHCTRLB.TRIGACT](#)). By default, a trigger generates a request for a block transfer operation. If a single descriptor is defined for a channel, the channel is automatically disabled when a block transfer has been completed. If a list of linked descriptors is defined for a channel, the channel is automatically disabled when the last descriptor in the list is executed. If the list still has descriptors to execute, the channel will be waiting for the next block transfer trigger. When enabled again, the channel will wait for the next block transfer trigger. The trigger actions can also be configured to generate a request for a beat transfer ([CHCTRLB.TRIGACT=0x2](#)) or transaction transfer ([CHCTRLB.TRIGACT=0x3](#)) instead of a block transfer ([CHCTRLB.TRIGACT=0x0](#)).

[Figure 26-7](#) shows an example where triggers are used with two linked block descriptors.

Figure 26-7. Trigger Action and Transfers



If the trigger source generates a transfer request for a channel during an ongoing transfer, the new transfer request will be kept pending (CHSTATUS.PEND=1), and the new transfer can start after the ongoing one is done. Only one pending transfer can be kept per channel. If the trigger source generates more transfer requests while one is already pending, the additional ones will be lost. All channels pending status flags are also available in the Pending Channels register (PENDCH).

When the transfer starts, the corresponding Channel Busy status flag is set in Channel Status register (CHSTATUS.BUSY). When the trigger action is complete, the Channel Busy status flag is cleared. All channel busy status flags are also available in the Busy Channels register (BUSYCH) in DMAC.

### 26.6.2.7 Addressing

Each block transfer needs to have both a source address and a destination address defined. The source address is set by writing the Transfer Source Address (SRCADDR) register, the destination address is set by writing the Transfer Destination Address (DSTADDR) register.

The addressing of this DMAC module can be static or incremental, for either source or destination of a block transfer, or both.

Incrementation for the source address of a block transfer is enabled by writing the Source Address Incrementation Enable bit in the Block Transfer Control register (BTCTRL.SRCINC=1). The step size of the incrementation is configurable and can be chosen by writing the Step Selection bit in the Block Transfer Control register (BTCTRL.STEPSEL=1) and writing the desired step size in the Address

Increment Step Size bit group in the Block Transfer Control register (**BTCTRL**.STEPSIZE). If **BTCTRL**.STEPSEL=0, the step size for the source incrementation will be the size of one beat.

When source address incrementation is configured (**BTCTRL**.SRCINC=1), **SRCADDR** is calculated as follows:

If **BTCTRL**.STEPSEL=1:

$$\text{SRCADDR} = \text{SRCADDR}_{\text{START}} + \text{BTCNT} \cdot (\text{BEATSIZE} + 1) \cdot 2^{\text{STEPSIZE}}$$

If **BTCTRL**.STEPSEL=0:

$$\text{SRCADDR} = \text{SRCADDR}_{\text{START}} + \text{BTCNT} \cdot (\text{BEATSIZE} + 1)$$

- $\text{SRCADDR}_{\text{START}}$  is the source address of the first beat transfer in the block transfer
- **BTCNT** is the initial number of beats remaining in the block transfer
- **BEATSIZE** is the configured number of bytes in a beat
- **STEPSIZE** is the configured number of beats for each incrementation

The following figure shows an example where DMA channel 0 is configured to increment the source address by one beat after each beat transfer (**BTCTRL**.SRCINC=1), and DMA channel 1 is configured to increment the source address by two beats (**BTCTRL**.SRCINC=1, **BTCTRL**.STEPSEL=1, and **BTCTRL**.STEPSIZE=0x1). As the destination address for both channels are peripherals, destination incrementation is disabled (**BTCTRL**.DSTINC=0).

**Figure 26-8. Source Address Increment**



Incrementation for the destination address of a block transfer is enabled by setting the Destination Address Incrementation Enable bit in the Block Transfer Control register (**BTCTRL**.DSTINC=1). The step size of the incrementation is configurable by clearing **BTCTRL**.STEPSEL=0 and writing **BTCTRL**.STEPSIZE to the desired step size. If **BTCTRL**.STEPSEL=1, the step size for the destination incrementation will be the size of one beat.

When the destination address incrementation is configured (**BTCTRL**.DSTINC=1), **SRCADDR** must be set and calculated as follows:

$\text{DSTADDR} = \text{DSTADDR}_{\text{START}} + \text{BTCNT} \cdot (\text{BEATSIZE} + 1) \cdot 2^{\text{STEPSIZE}}$	where <b>BTCTRL</b> .STEPSEL is zero
$\text{DSTADDR} = \text{DSTADDR}_{\text{START}} + \text{BTCNT} \cdot (\text{BEATSIZE} + 1)$	where <b>BTCTRL</b> .STEPSEL is one

- $\text{DSTADDR}_{\text{START}}$  is the destination address of the first beat transfer in the block transfer
- **BTCNT** is the initial number of beats remaining in the block transfer

- BEATSIZE is the configured number of bytes in a beat
- STEPSIZE is the configured number of beats for each incrementation

Figure 26-9 shows an example where DMA channel 0 is configured to increment destination address by one beat (`BTCTRL.DSTINC=1`) and DMA channel 1 is configured to increment destination address by two beats (`BTCTRL.DSTINC=1`, `BTCTRL.STEPSEL=0`, and `BTCTRL.STEPSIZE=0x1`). As the source address for both channels are peripherals, source incrementation is disabled (`BTCTRL.SRCINC=0`).

**Figure 26-9. Destination Address Increment**



### 26.6.2.8 Error Handling

If a bus error is received from an AHB slave during a DMA data transfer, the corresponding active channel is disabled and the corresponding Channel Transfer Error Interrupt flag in the Channel Interrupt Status and Clear register (`CHINTFLAG.TERR`) is set. If enabled, the optional transfer error interrupt is generated. The transfer counter will not be decremented and its current value is written-back in the write-back memory section before the channel is disabled.

When the DMAC fetches an invalid descriptor (`BTCTRL.VALID=0`) or when the channel is resumed and the DMA fetches the next descriptor with null address (`DESCADDR=0x00000000`), the corresponding channel operation is suspended, the Channel Suspend Interrupt Flag in the Channel Interrupt Flag Status and Clear register (`CHINTFLAG.SUSP`) is set, and the Channel Fetch Error bit in the Channel Status register (`CHSTATUS.FERR`) is set. If enabled, the optional suspend interrupt is generated.

### 26.6.3 Additional Features

#### 26.6.3.1 Linked Descriptors

A transaction can consist of either a single block transfer or of several block transfers. When a transaction consist of several block transfers it is called linked descriptors.

Figure 26-3 illustrates how linked descriptors work. When the first block transfer is completed on DMA channel 0, the DMAC fetches the next transfer descriptor which is pointed to by the value stored in the Next Descriptor Address (`DESCADDR`) register of the first transfer descriptor. Fetching the next transfer descriptor (`DESCADDR`) is continued until the last transfer descriptor. When the block transfer for the last transfer descriptor is executed and `DESCADDR=0x00000000`, the transaction is terminated. For further details on how the next descriptor is fetched from SRAM, refer to section [Data Transmission](#).

#### Adding Descriptor to the End of a List

To add a new descriptor at the end of the descriptor list, create the descriptor in SRAM, with `DESCADDR=0x00000000` indicating that it is the new last descriptor in the list, and modify the `DESCADDR` value of the current last descriptor to the address of the newly created descriptor.

#### Modifying a Descriptor in a List

In order to add descriptors to a linked list, the following actions must be performed:



1. Enable the Suspend interrupt for the DMA channel.
2. Enable the DMA channel.
3. Reserve memory space in SRAM to configure a new descriptor.
4. Configure the new descriptor:
  - Set the next descriptor address ([DESCADDR](#))
  - Set the destination address ([DSTADDR](#))
  - Set the source address ([SRCADDR](#))
  - Configure the block transfer control ([BTCTRL](#)) including
    - Optionally enable the Suspend block action
    - Set the descriptor VALID bit
5. Clear the VALID bit for the existing list and for the descriptor which has to be updated.
6. Read [DESCADDR](#) from the Write-Back memory.
  - If the DMA has not already fetched the descriptor which requires changes (i.e., [DESCADDR](#) is wrong):
    - Update the [DESCADDR](#) location of the descriptor from the List
    - Optionally clear the Suspend block action
    - Set the descriptor VALID bit to '1'
    - Optionally enable the Resume software command
  - If the DMA is executing the same descriptor as the one which requires changes:
    - Set the Channel Suspend software command and wait for the Suspend interrupt
    - Update the next descriptor address ([DESCRADDR](#)) in the write-back memory
    - Clear the interrupt sources and set the Resume software command
    - Update the [DESCADDR](#) location of the descriptor from the List
    - Optionally clear the Suspend block action
    - Set the descriptor VALID bit to '1'
7. Go to step 4 if needed.

### Adding a Descriptor Between Existing Descriptors

To insert a new descriptor 'C' between two existing descriptors ('A' and 'B'), the descriptor currently executed by the DMA must be identified.

1. If DMA is executing descriptor B, descriptor C cannot be inserted.
2. If DMA has not started to execute descriptor A, follow the steps:
  - 2.1. Set the descriptor A VALID bit to '0'.
  - 2.2. Set the [DESCADDR](#) value of descriptor A to point to descriptor C instead of descriptor B.
  - 2.3. Set the [DESCADDR](#) value of descriptor C to point to descriptor B.
  - 2.4. Set the descriptor A VALID bit to '1'.
3. If DMA is executing descriptor A:
  - 3.1. Apply the software suspend command to the channel and
  - 3.2. Perform steps 2.1 through 2.4.
  - 3.3. Apply the software resume command to the channel.

### 26.6.3.2 Channel Suspend

The channel operation can be suspended at any time by software by writing a '1' to the Suspend command in the Command bit field of Channel Control B register ([CHCTRLB.CMD](#)). After the ongoing burst transfer is completed, the channel operation is suspended and the suspend command is automatically cleared.

When suspended, the Channel Suspend Interrupt flag in the Channel Interrupt Status and Clear register is set (CHINTFLAG.SUSP=1) and the optional suspend interrupt is generated.

By configuring the block action to suspend by writing Block Action bit group in the Block Transfer Control register (BTCTRL.BLOCKACT is 0x2 or 0x3), the DMA channel will be suspended after it has completed a block transfer. The DMA channel will be kept enabled and will be able to receive transfer triggers, but it will be removed from the arbitration scheme.

If an invalid transfer descriptor (BTCTRL.VALID=0) is fetched from SRAM, the DMA channel will be suspended, and the Channel Fetch Error bit in the Channel Status register(CHASTATUS.FERR) will be set.

**Note:** Only enabled DMA channels can be suspended. If a channel is disabled when it is attempted to be suspended, the internal suspend command will be ignored.

For more details on transfer descriptors, refer to section [Transfer Descriptors](#).

**Related Links**

[CHCTRLB](#)

[CHINTFLAG](#)

[BTCTRL](#)

**26.6.3.3 Channel Resume and Next Suspend Skip**

A channel operation can be resumed by software by setting the Resume command in the Command bit field of the Channel Control B register (CHCTRLB.CMD). If the channel is already suspended, the channel operation resumes from where it previously stopped when the Resume command is detected. When the Resume command is issued before the channel is suspended, the next suspend action is skipped and the channel continues the normal operation.

**Figure 26-10. Channel Suspend/Resume Operation**



**Related Links**

[CHCTRLB](#)

**26.6.3.4 Event Input Actions**

The event input actions are available only on the least significant DMA channels. For details on channels with event input support, refer to the in the Event system documentation.

Before using event input actions, the event controller must be configured first according to the following table, and the Channel Event Input Enable bit in the Channel Control B register (CHCTRLB.EVIE) must be written to '1'. Refer also to [Events](#).

**Table 26-1. Event Input Action**

Action	CHCTRLB.EVACT	CHCTRLB.TRGSRC
None	NOACT	-
Normal Transfer	TRIG	DISABLE

Action	CHCTRLB.EVACT	CHCTRLB.TRGSRC
Conditional Transfer on Strobe	TRIG	any peripheral
Conditional Transfer	CTRIG	
Conditional Block Transfer	CBLOCK	
Channel Suspend	SUSPEND	
Channel Resume	RESUME	
Skip Next Block Suspend	SSKIP	

### Normal Transfer

The event input is used to trigger a beat or burst transfer on peripherals.

The event is acknowledged as soon as the event is received. When received, both the Channel Pending status bit in the Channel Status register ([CHSTATUS.PEND](#)) and the corresponding Channel n bit in the Pending Channels register ([PENDCH.PENDCHn](#)) are set. If the event is received while the channel is pending, the event trigger is lost.

The figure below shows an example where beat transfers are enabled by internal events.

**Figure 26-11. Beat Event Trigger Action**



### Conditional Transfer on Strobe

The event input is used to trigger a transfer on peripherals with pending transfer requests. This event action is intended to be used with peripheral triggers, e.g. for timed communication protocols or periodic transfers between peripherals: only when the peripheral trigger coincides with the occurrence of a (possibly cyclic) event the transfer is issued.

The event is acknowledged as soon as the event is received. The peripheral trigger request is stored internally when the previous trigger action is completed (i.e. the channel is not pending) and when an active event is received. If the peripheral trigger is active, the DMA will wait for an event before the peripheral trigger is internally registered. When both event and peripheral transfer trigger are active, both [CHSTATUS.PEND](#) and [PENDCH.PENDCHn](#) are set. A software trigger will now trigger a transfer.

The figure below shows an example where the peripheral beat transfer is started by a conditional strobe event action.

**Figure 26-12. Periodic Event with Beat Peripheral Triggers**



**Conditional Transfer**

The event input is used to trigger a conditional transfer on peripherals with pending transfer requests. As example, this type of event can be used for peripheral-to-peripheral transfers, where one peripheral is the source of event and the second peripheral is the source of the trigger.

Each peripheral trigger is stored internally when the event is received. When the peripheral trigger is stored internally, the Channel Pending status bit is set (`CHSTATUS.PEND`), the respective Pending Channel n Bit in the Pending Channels register is set (`PENDCH.PENDCHn`), and the event is acknowledged. A software trigger will now trigger a transfer.

The figure below shows an example where conditional event is enabled with peripheral beat trigger requests.

**Figure 26-13. Conditional Event with Beat Peripheral Triggers**

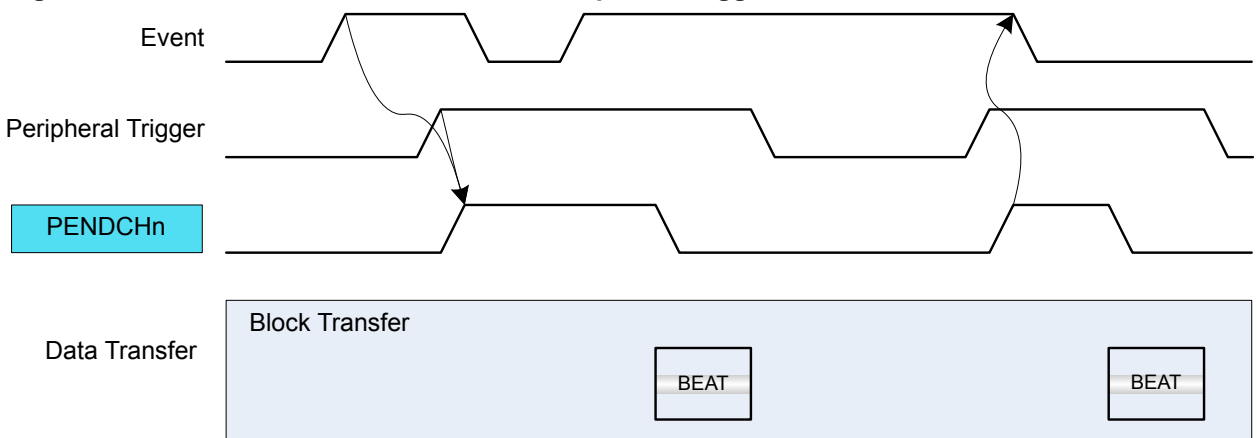

**Conditional Block Transfer**

The event input is used to trigger a conditional block transfer on peripherals.

Before starting transfers within a block, an event must be received. When received, the event is acknowledged when the block transfer is completed. A software trigger will trigger a transfer.

The figure below shows an example where conditional event block transfer is started with peripheral beat trigger requests.

**Figure 26-14. Conditional Block Transfer with Beat Peripheral Triggers**



**Channel Suspend**

The event input is used to suspend an ongoing channel operation. The event is acknowledged when the current AHB access is completed. For further details on Channel Suspend, refer to [Channel Suspend](#).

**Channel Resume**

The event input is used to resume a suspended channel operation. The event is acknowledged as soon as the event is received and the Channel Suspend Interrupt Flag ([CHINTFLAG.SUSP](#)) is cleared. For further details refer to [Channel Suspend](#).

**Skip Next Block Suspend**

This event can be used to skip the next block suspend action. If the channel is suspended before the event rises, the channel operation is resumed and the event is acknowledged. If the event rises before a suspend block action is detected, the event is kept until the next block suspend detection. When the block transfer is completed, the channel continues the operation (not suspended) and the event is acknowledged.

**26.6.3.5 Event Output Selection**

Event output selection is available only for the least significant DMA channels. The pulse width of an event output from a channel is one AHB clock cycle.

The output of channel events is enabled by writing a '1' to the Channel Event Output Enable bit in the Control B register ([CHCTRLB.EVOE](#)). The event output cause is selected by writing to the Event Output Selection bits in the Block Transfer Control register ([BTCTRL.EVOSEL](#)). It is possible to generate events after each block transfer ([BTCTRL.EVOSEL=0x1](#)) or beat transfer ([BTCTRL.EVOSEL=0x3](#)). To enable an event being generated when a transaction is complete, the block event selection must be set in the last transfer descriptor only.

The figure [Figure 26-15](#) shows an example where the event output generation is enabled in the first block transfer, and disabled in the second block.

**Figure 26-15. Event Output Generation**

**Beat Event Output**



**Block Event Output**



**Related Links**

[CHCTRLB](#)

[BTCtrl](#)

**26.6.3.6 Aborting Transfers**

Transfers on any channel can be aborted gracefully by software by disabling the corresponding DMA channel. It is also possible to abort all ongoing or pending transfers by disabling the DMAC.

When a DMA channel disable request or DMAC disable request is detected:

- Ongoing transfers of the active channel will be disabled when the ongoing beat transfer is completed and the write-back memory section is updated. This prevents transfer corruption before the channel is disabled.
- All other enabled channels will be disabled in the next clock cycle.

The corresponding Channel Enable bit in the Channel Control A register is cleared (CHCTRLA.ENABLE=0) when the channel is disabled.

The corresponding DMAC Enable bit in the Control register is cleared (CTRL.DMAENABLE=0) when the entire DMAC module is disabled.

**26.6.3.7 CRC Operation**

A cyclic redundancy check (CRC) is an error detection technique used to find errors in data. It is commonly used to determine whether the data during a transmission, or data present in data and program memories has been corrupted or not. A CRC takes a data stream or a block of data as input and generates a 16- or 32-bit output that can be appended to the data and used as a checksum.

When the data is received, the device or application repeats the calculation: If the new CRC result does not match the one calculated earlier, the block contains a data error. The application will then detect this and may take a corrective action, such as requesting the data to be sent again or simply not using the incorrect data.

The CRC engine in DMAC supports two commonly used CRC polynomials: CRC-16 (CRC-CCITT) and CRC-32 (IEEE 802.3). Typically, applying CRC-n (CRC-16 or CRC-32) to a data block of arbitrary length will detect any single alteration that is  $\leq n$  bits in length, and will detect the fraction  $1-2^{-n}$  of all longer error bursts.

- CRC-16:
  - Polynomial:  $x^{16} + x^{12} + x^5 + 1$
  - Hex value: 0x1021
- CRC-32:
  - Polynomial:  $x^{32} + x^{26} + x^{23} + x^{22} + x^{16} + x^{12} + x^{11} + x^{10} + x^8 + x^7 + x^5 + x^4 + x^2 + x + 1$
  - Hex value: 0x04C11DB7

The data source for the CRC engine can either be one of the DMA channels or the APB bus interface, and must be selected by writing to the CRC Input Source bits in the CRC Control register (CRCCTRL.CRCSRC). The CRC engine then takes data input from the selected source and generates a checksum based on these data. The checksum is available in the CRC Checksum register (CRCCHKSUM). When CRC-32 polynomial is used, the final checksum read is bit reversed and complemented, as shown in [Figure 26-16](#).

The CRC polynomial is selected by writing to the CRC Polynomial Type bit in the CRC Control register (CRCCTRL.CRCPOLY), the default is CRC-16. The CRC engine operates on byte only. When the DMA is used as data source for the CRC engine, the DMA channel beat size setting will be used. When used with APB bus interface, the application must select the CRC Beat Size bit field of CRC Control register (CRCCTRL.CRCBEATSIZE). 8-, 16-, or 32-bit bus transfer access type is supported. The corresponding number of bytes will be written in the [CRCDATAIN](#) register and the CRC engine will operate on the input data in a byte by byte manner.

Figure 26-16. CRC Generator Block Diagram



**CRC on DMA data** CRC-16 or CRC-32 calculations can be performed on data passing through any DMA channel. Once a DMA channel is selected as the source, the CRC engine will continuously generate the CRC on the data passing through the DMA channel. The checksum is available for readout once the DMA transaction is completed or aborted. A CRC can also be generated on SRAM, Flash, or I/O memory by passing these data through a DMA channel. If the latter is done, the destination register for the DMA data can be the data input (CRCDATAIN) register in the CRC engine.

**CRC using the I/O interface** Before using the CRC engine with the I/O interface, the application must set the CRC Beat Size bits in the CRC Control register (CRCCTRL.CRCBEATSIZE). 8/16/32-bit bus transfer type can be selected.

CRC can be performed on any data by loading them into the CRC engine using the CPU and writing the data to the CRCDATAIN register. Using this method, an arbitrary number of bytes can be written to the register by the CPU, and CRC is done continuously for each byte. This means if a 32-bit data is written to the CRCDATAIN register the CRC engine takes four cycles to calculate the CRC. The CRC complete is signaled by a set CRCBUSY bit in the CRCSTATUS register. New data can be written only when CRCBUSY flag is not set.

**26.6.4 DMA Operation**  
Not applicable.



## 26.6.5 Interrupts

The DMAC channels have the following interrupt sources:

- Transfer Complete (TCMPL): Indicates that a block transfer is completed on the corresponding channel. Refer to [Data Transmission](#) for details.
- Transfer Error (TERR): Indicates that a bus error has occurred during a burst transfer, or that an invalid descriptor has been fetched. Refer to [Error Handling](#) for details.
- Channel Suspend (SUSP): Indicates that the corresponding channel has been suspended. Refer to [Channel Suspend](#) and [Data Transmission](#) for details.

Each interrupt source has an interrupt flag associated with it. The interrupt flag in the Channel Interrupt Flag Status and Clear (CHINTFLAG) register is set when the interrupt condition occurs. Each interrupt can be individually enabled by setting the corresponding bit in the Channel Interrupt Enable Set register (CHINTENSET=1), and disabled by setting the corresponding bit in the Channel Interrupt Enable Clear register (CHINTENCLR=1).

An interrupt request is generated when the interrupt flag is set and the corresponding interrupt is enabled. The interrupt request remains active until the interrupt flag is cleared, the interrupt is disabled, the DMAC is reset or the corresponding DMA channel is reset. See CHINTFLAG for details on how to clear interrupt flags. All interrupt requests are ORed together on system level to generate one combined interrupt request to the NVIC.

The user must read the Channel Interrupt Status (INTSTATUS) register to identify the channels with pending interrupts and must read the Channel Interrupt Flag Status and Clear (CHINTFLAG) register to determine which interrupt condition is present for the corresponding channel. It is also possible to read the Interrupt Pending register (INTPEND), which provides the lowest channel number with pending interrupt and the respective interrupt flags.

**Note:** Interrupts must be globally enabled for interrupt requests to be generated.

### Related Links

[Nested Vector Interrupt Controller](#)

## 26.6.6 Events

The DMAC can generate the following output events:

- Channel (CH): Generated when a block transfer for a given channel has been completed, or when a beat transfer within a block transfer for a given channel has been completed. Refer to Event Output Selection section for details.

Setting the Channel Control B Event Output Enable bit (CHCTRLB.EVOE=1) enables the corresponding output event configured in the Event Output Selection bit group in the Block Transfer Control register (BTCTRL.EVOSEL). Clearing CHCTRLB.EVOE=0 disables the corresponding output event.

The DMAC can take the following actions on an input event:

- Transfer and Periodic Transfer Trigger (TRIG): normal transfer or periodic transfers on peripherals are enabled
- Conditional Transfer Trigger (CTRIG): conditional transfers on peripherals are enabled
- Conditional Block Transfer Trigger (CBLOCK): conditional block transfers on peripherals are enabled
- Channel Suspend Operation (SUSPEND): suspend a channel operation
- Channel Resume Operation (RESUME): resume a suspended channel operation
- Skip Next Block Suspend Action (SSKIP): skip the next block suspend transfer condition

- Increase Priority (INCPRI): increase channel priority

Setting the Channel Control B Event Input Enable bit (CHCTRLB.EVIE=1) enables the corresponding action on input event. Clearing this bit disables the corresponding action on input event. Note that several actions can be enabled for incoming events. If several events are connected to the peripheral, any enabled action will be taken for any of the incoming events. For further details on event input actions, refer to Event Input Action section.

#### Related Links

[EVSYS – Event System](#)

[CHCTRLB](#)

[BTCTRL](#)

### 26.6.7 Sleep Mode Operation

Each DMA channel can be configured to operate in any sleep mode. To be able to run in standby, the RUNSTDBY bit in Channel Control A register (CHCTRLA.RUNSTDBY) must be written to '1'. The DMAC can wake up the device using interrupts from any sleep mode or perform actions through the Event System.

For channels with CHCTRLA.RUNSTDBY=0, it is up to software to stop DMA transfers on these channels and wait for completion before going to standby mode using the following sequence:

1. Suspend the DMAC channels for which CHCTRLA.RUNSTDBY=0.
2. Check the SYNCBUSY bits of registers accessed by the DMAC channels being suspended.
3. Go to sleep
4. When the device wakes up, resume the suspended channels.

**Note:** In standby sleep mode, the DMAC can only access RAM when it is not back biased (PM.STDBYCFG.BBIASxx=0x0)

### 26.6.8 Synchronization

Not applicable.

## 26.7 Register Summary

Offset	Name	Bit Pos.									
0x00	CTRL	7:0						CRCENABLE	DMAENABLE	SWRST	
0x01		15:8					LVLENx3	LVLENx2	LVLENx1	LVLENx0	
0x02	CRCCTRL	7:0					CRCPOLY[1:0]		CRCBEATSIZE[1:0]		
0x03		15:8					CRCSRC[5:0]				
0x04	CRCDATAIN	7:0					CRCDATAIN[7:0]				
0x05		15:8					CRCDATAIN[15:8]				
0x06		23:16					CRCDATAIN[23:16]				
0x07		31:24					CRCDATAIN[31:24]				
0x08	CRCCHKSUM	7:0					CRCCHKSUM[7:0]				
0x09		15:8					CRCCHKSUM[15:8]				
0x0A		23:16					CRCCHKSUM[23:16]				
0x0B		31:24					CRCCHKSUM[31:24]				
0x0C	CRCSTATUS	7:0						CRCZERO	CRCBUSY		
0x0D	DBGCTRL	7:0							DBGRUN		
0x0E	QOSCTRL	7:0			DQOS[1:0]		FQOS[1:0]		WRBQOS[1:0]		
0x0F	Reserved										
0x10	SWTRIGCTRL	7:0			SWTRIGn	SWTRIGn	SWTRIGn	SWTRIGn	SWTRIGn	SWTRIGn	
0x11		15:8									
0x12		23:16									
0x13		31:24									
0x14	PRICTRL0	7:0	RRLVLEN0					LVLPRIO[3:0]			
0x15		15:8	RRLVLEN1					LVLPRIO[3:0]			
0x16		23:16	RRLVLEN2					LVLPRIO[3:0]			
0x17		31:24	RRLVLEN3					LVLPRIO[3:0]			
0x18 ... 0x1F	Reserved										
0x20	INTPEND	7:0					ID[3:0]				
0x21		15:8	PEND	BUSY	FERR			SUSP	TCMPL	TERR	
0x22 ... 0x23	Reserved										
0x24	INTSTATUS	7:0			CHINTn	CHINTn	CHINTn	CHINTn	CHINTn	CHINTn	
0x25		15:8									
0x26		23:16									
0x27		31:24									
0x28	BUSYCH	7:0			BUSYCHn	BUSYCHn	BUSYCHn	BUSYCHn	BUSYCHn	BUSYCHn	
0x29		15:8									
0x2A		23:16									
0x2B		31:24									
0x2C	PENDCH	7:0			PENDCH5	PENDCH4	PENDCH3	PENDCH2	PENDCH1	PENDCH0	
0x2D		15:8									
0x2E		23:16									
0x2F		31:24									

Offset	Name	Bit Pos.									
0x30	ACTIVE	7:0					LVLEXx	LVLEXx	LVLEXx	LVLEXx	
0x31		15:8	ABUSY			ID[4:0]					
0x32		23:16	BTCNT[7:0]								
0x33		31:24	BTCNT[15:8]								
0x34	BASEADDR	7:0	BASEADDR[7:0]								
0x35		15:8	BASEADDR[15:8]								
0x36		23:16	BASEADDR[23:16]								
0x37		31:24	BASEADDR[31:24]								
0x38	WRBADDR	7:0	WRBADDR[7:0]								
0x39		15:8	WRBADDR[15:8]								
0x3A		23:16	WRBADDR[23:16]								
0x3B		31:24	WRBADDR[31:24]								
0x3C ... 0x3E	Reserved										
0x3F	CHID	7:0				ID[3:0]					
0x40	CHCTRLA	7:0		RUNSTDBY					ENABLE	SWRST	
0x41 ... 0x43	Reserved										
0x44	CHCTRLB	7:0		LVL[1:0]	EVOE	EVIE	EVACT[2:0]				
0x45		15:8	TRIGSRC[5:0]								
0x46		23:16	TRIGACT[1:0]								
0x47		31:24	CMD[1:0]								
0x48 ... 0x4B	Reserved										
0x4C	CHINTENCLR	7:0					SUSP	TCMPL	TERR		
0x4D	CHINTENSET	7:0					SUSP	TCMPL	TERR		
0x4E	CHINTFLAG	7:0					SUSP	TCMPL	TERR		
0x4F	CHSTATUS	7:0					FERR	BUSY	PEND		

## 26.8 Register Description

Registers can be 8, 16, or 32 bits wide. Atomic 8-, 16- and 32-bit accesses are supported. In addition, the 8-bit quarters and 16-bit halves of a 32-bit register, and the 8-bit halves of a 16-bit register can be accessed directly.

Some registers are optionally write-protected by the Peripheral Access Controller (PAC). Optional PAC write-protection is denoted by the "PAC Write-Protection" property in each individual register description. For details, refer to [Register Access Protection](#).

Some registers are enable-protected, meaning they can only be written when the peripheral is disabled. Enable-protection is denoted by the "Enable-Protected" property in each individual register description.

### 26.8.1 Control

**Name:** CTRL  
**Offset:** 0x00 [ID-00001ece]  
**Reset:** 0x00X0  
**Property:** PAC Write-Protection, Enable-Protected

	15	14	13	12	11	10	9	8	
					LVLENx3	LVLENx2	LVLENx1	LVLENx0	
Access					R/W	R/W	R/W	R/W	
Reset					0	0	0	0	
	7	6	5	4	3	2	1	0	
							CRCENABLE	DMAENABLE	SWRST
Access							R/W	R/W	R/W
Reset							0	0	0

**Bits 8, 9, 10, 11 – LVLENx: Priority Level x Enable**

When this bit is set, all requests with the corresponding level will be fed into the arbiter block. When cleared, all requests with the corresponding level will be ignored.

For details on arbitration schemes, refer to the [Arbitration](#) section.

These bits are not enable-protected.

Value	Description
0	Transfer requests for Priority level x will not be handled.
1	Transfer requests for Priority level x will be handled.

**Bit 2 – CRCENABLE: CRC Enable**

Writing a '0' to this bit will disable the CRC calculation when the CRC Status Busy flag is cleared (CRCSTATUS.CRCBUSY). The bit is zero when the CRC is disabled.

Writing a '1' to this bit will enable the CRC calculation.

Value	Description
0	The CRC calculation is disabled.
1	The CRC calculation is enabled.

**Bit 1 – DMAENABLE: DMA Enable**

Setting this bit will enable the DMA module.

Writing a '0' to this bit will disable the DMA module. When writing a '0' during an ongoing transfer, the bit will not be cleared until the internal data transfer buffer is empty and the DMA transfer is aborted. The internal data transfer buffer will be empty once the ongoing burst transfer is completed.

This bit is not enable-protected.

Value	Description
0	The peripheral is disabled.
1	The peripheral is enabled.

**Bit 0 – SWRST: Software Reset**

Writing a '0' to this bit has no effect.

Writing a '1' to this bit when both the DMAC and the CRC module are disabled (DMAENABLE and CRCENABLE are '0') resets all registers in the DMAC (except DBGCTRL) to their initial state. If either the DMAC or CRC module is enabled, the Reset request will be ignored and the DMAC will return an access error.

Value	Description
0	There is no Reset operation ongoing.
1	A Reset operation is ongoing.

## 26.8.2 CRC Control

**Name:** CRCCTRL

**Offset:** 0x02 [ID-00001ece]

**Reset:** 0x0000

**Property:** PAC Write-Protection, Enable-Protected

Bit	15	14	13	12	11	10	9	8
			CRCSRC[5:0]					
Access			R/W	R/W	R/W	R/W	R/W	R/W
Reset			0	0	0	0	0	0
Bit	7	6	5	4	3	2	1	0
			CRCPOLY[1:0]			CRCBEATSIZE[1:0]		
Access					R/W	R/W	R/W	R/W
Reset					0	0	0	0

### Bits 13:8 – CRCSRC[5:0]: CRC Input Source

These bits select the input source for generating the CRC, as shown in the table below. The selected source is locked until either the CRC generation is completed or the CRC module is disabled. This means the CRCSRC cannot be modified when the CRC operation is ongoing. The lock is signaled by the CRCBUSY status bit. CRC generation complete is generated and signaled from the selected source when used with the DMA channel.

Value	Name	Description
0x00	NOACT	No action
0x01	IO	I/O interface
0x02-0x1F	-	Reserved
0x20	CHN	DMA channel 0
0x21	CHN	DMA channel 1
0x22	CHN	DMA channel 2
0x23	CHN	DMA channel 3
0x24	CHN	DMA channel 4
0x25	CHN	DMA channel 5
0x26	CHN	DMA channel 6
0x27	CHN	DMA channel 7
0x28	CHN	DMA channel 8
0x29	CHN	DMA channel 9
0x2A	CHN	DMA channel 10
0x2B	CHN	DMA channel 11

Value	Name	Description
0x2C	CHN	DMA channel 12
0x2D	CHN	DMA channel 13
0x2E	CHN	DMA channel 14
0x2F	CHN	DMA channel 15
0x30	CHN	DMA channel 16
0x31	CHN	DMA channel 17
0x32	CHN	DMA channel 18
0x33	CHN	DMA channel 19
0x34	CHN	DMA channel 20
0x35	CHN	DMA channel 21
0x36	CHN	DMA channel 22
0x37	CHN	DMA channel 23
0x38	CHN	DMA channel 24
0x39	CHN	DMA channel 25
0x3A	CHN	DMA channel 26
0x3B	CHN	DMA channel 27
0x3C	CHN	DMA channel 28
0x3D	CHN	DMA channel 29
0x3E	CHN	DMA channel 30
0x3F	CHN	DMA channel 31

### Bits 3:2 – CRCPOLY[1:0]: CRC Polynomial Type

These bits define the size of the data transfer for each bus access when the CRC is used with I/O interface, as shown in the table below.

Value	Name	Description
0x0	CRC16	CRC-16 (CRC-CCITT)
0x1	CRC32	CRC32 (IEEE 802.3)
0x2-0x3		Reserved

### Bits 1:0 – CRCBEATSIZE[1:0]: CRC Beat Size

These bits define the size of the data transfer for each bus access when the CRC is used with I/O interface.

Value	Name	Description
0x0	BYTE	8-bit bus transfer
0x1	HWORDB	16-bit bus transfer
0x2	WORD	32-bit bus transfer
0x3		Reserved

## 26.8.3 CRC Data Input

**Name:** CRCDATAIN  
**Offset:** 0x04 [ID-00001ece]  
**Reset:** 0x00000000  
**Property:** PAC Write-Protection

Bit	31	30	29	28	27	26	25	24
	CRCDATAIN[31:24]							
Access	R/W	R/W	R/W	R/W	R/W	R/W	R/W	R/W
Reset	0	0	0	0	0	0	0	0
Bit	23	22	21	20	19	18	17	16
	CRCDATAIN[23:16]							
Access	R/W	R/W	R/W	R/W	R/W	R/W	R/W	R/W
Reset	0	0	0	0	0	0	0	0
Bit	15	14	13	12	11	10	9	8
	CRCDATAIN[15:8]							
Access	R/W	R/W	R/W	R/W	R/W	R/W	R/W	R/W
Reset	0	0	0	0	0	0	0	0
Bit	7	6	5	4	3	2	1	0
	CRCDATAIN[7:0]							
Access	R/W	R/W	R/W	R/W	R/W	R/W	R/W	R/W
Reset	0	0	0	0	0	0	0	0

**Bits 31:0 – CRCDATAIN[31:0]: CRC Data Input**

These bits store the data for which the CRC checksum is computed. A new CRC Checksum is ready (CRCBEAT+ 1) clock cycles after the CRCDATAIN register is written.

**26.8.4 CRC Checksum**

The CRCCHKSUM represents the 16- or 32-bit checksum value and the generated CRC. The register is reset to zero by default, but it is possible to reset all bits to one by writing the CRCCHKSUM register directly. It is possible to write this register only when the CRC module is disabled. If CRC-32 is selected and the CRC Status Busy flag is cleared (i.e., CRC generation is completed or aborted), the bit reversed (bit 31 is swapped with bit 0, bit 30 with bit 1, etc.) and complemented result will be read from CRCCHKSUM. If CRC-16 is selected or the CRC Status Busy flag is set (i.e., CRC generation is ongoing), CRCCHKSUM will contain the actual content.

**Name:** CRCCHKSUM

**Offset:** 0x08 [ID-00001ece]

**Reset:** 0x00000000

**Property:** PAC Write-Protection, Enable-Protected



Bit	31	30	29	28	27	26	25	24
	CRCCHKSUM[31:24]							
Access	R/W	R/W	R/W	R/W	R/W	R/W	R/W	R/W
Reset	0	0	0	0	0	0	0	0
Bit	23	22	21	20	19	18	17	16
	CRCCHKSUM[23:16]							
Access	R/W	R/W	R/W	R/W	R/W	R/W	R/W	R/W
Reset	0	0	0	0	0	0	0	0
Bit	15	14	13	12	11	10	9	8
	CRCCHKSUM[15:8]							
Access	R/W	R/W	R/W	R/W	R/W	R/W	R/W	R/W
Reset	0	0	0	0	0	0	0	0
Bit	7	6	5	4	3	2	1	0
	CRCCHKSUM[7:0]							
Access	R/W	R/W	R/W	R/W	R/W	R/W	R/W	R/W
Reset	0	0	0	0	0	0	0	0

**Bits 31:0 – CRCCHKSUM[31:0]: CRC Checksum**

These bits store the generated CRC result. The 16 MSB bits are always read zero when CRC-16 is enabled.

### 26.8.5 CRC Status

**Name:** CRCSTATUS  
**Offset:** 0x0C [ID-00001ece]  
**Reset:** 0x00  
**Property:** PAC Write-Protection

Bit	7	6	5	4	3	2	1	0
							CRCZERO	CRCBUSY
Access							R	R/W
Reset							0	0

**Bit 1 – CRCZERO: CRC Zero**

This bit is cleared when a new CRC source is selected.

This bit is set when the CRC generation is complete and the CRC Checksum is zero.

When running CRC-32 and appending the checksum at the end of the packet (as little endian), the final checksum should be 0x2144df1c, and not zero. However, if the checksum is complemented before it is appended (as little endian) to the data, the final result in the checksum register will be zero. See the description of CRCCHKSUM to read out different versions of the checksum.

**Bit 0 – CRCBUSY: CRC Module Busy**

This flag is cleared by writing a one to it when used with I/O interface. When used with a DMA channel, the bit is set when the corresponding DMA channel is enabled, and cleared when the corresponding DMA channel is disabled. This register bit cannot be cleared by the application when the CRC is used with a DMA channel.

This bit is set when a source configuration is selected and as long as the source is using the CRC module.

## 26.8.6 Debug Control

**Name:** DBGCTRL  
**Offset:** 0x0D [ID-00001ece]  
**Reset:** 0x00  
**Property:** PAC Write-Protection

	7	6	5	4	3	2	1	0
								DBGRUN
Access								R/W
Reset								0

### Bit 0 – DBGRUN: Debug Run

This bit is not reset by a software reset.

This bit controls the functionality when the CPU is halted by an external debugger.

Value	Description
0	The DMAC is halted when the CPU is halted by an external debugger.
1	The DMAC continues normal operation when the CPU is halted by an external debugger.

## 26.8.7 Quality of Service Control

**Name:** QOSCTRL  
**Offset:** 0x0E [ID-00001ece]  
**Reset:** 0x2A  
**Property:** PAC Write-Protection

	7	6	5	4	3	2	1	0
			DQOS[1:0]		FQOS[1:0]		WRBQOS[1:0]	
Access			R/W	R/W	R/W	R/W	R/W	R/W
Reset			1	0	1	0	1	0

### Bits 5:4 – DQOS[1:0]: Data Transfer Quality of Service

These bits define the memory priority access during the data transfer operation.

DQOS[1:0]	Name	Description
0x0	DISABLE	Background (no sensitive operation)
0x1	LOW	Sensitive Bandwidth
0x2	MEDIUM	Sensitive Latency
0x3	HIGH	Critical Latency

### Bits 3:2 – FQOS[1:0]: Fetch Quality of Service

These bits define the memory priority access during the fetch operation.

FQOS[1:0]	Name	Description
0x0	DISABLE	Background (no sensitive operation)
0x1	LOW	Sensitive Bandwidth
0x2	MEDIUM	Sensitive Latency
0x3	HIGH	Critical Latency

**Bits 1:0 – WRBQOS[1:0]: Write-Back Quality of Service**

These bits define the memory priority access during the write-back operation.

WRBQOS[1:0]	Name	Description
0x0	DISABLE	Background (no sensitive operation)
0x1	LOW	Sensitive Bandwidth
0x2	MEDIUM	Sensitive Latency
0x3	HIGH	Critical Latency

**26.8.8 Software Trigger Control**

**Name:** SWTRIGCTRL  
**Offset:** 0x10 [ID-00001ece]  
**Reset:** 0x00000000  
**Property:** PAC Write-Protection



**Bits 5:0 – SWTRIGn: Channel n Software Trigger [n = 5..0]**

This bit is cleared when the Channel Pending bit in the Channel Status register ([CHSTATUS.PEND](#)) for the corresponding channel is either set, or by writing a '1' to it.

This bit is set if `CHSTATUS.PEND` is already '1' when writing a '1' to that bit.

Writing a '0' to this bit will clear the bit.

Writing a '1' to this bit will generate a DMA software trigger on channel x, if `CHSTATUS.PEND=0` for channel x. `CHSTATUS.PEND` will be set and `SWTRIGn` will remain cleared.

## 26.8.9 Priority Control 0

**Name:** PRICTRL0  
**Offset:** 0x14 [ID-00001ece]  
**Reset:** 0x00000000  
**Property:** PAC Write-Protection

Bit	31	30	29	28	27	26	25	24
	RRLVLEN3			LVLPR13[3:0]				
Access	R/W				R/W	R/W	R/W	R/W
Reset	0				0	0	0	0
Bit	23	22	21	20	19	18	17	16
	RRLVLEN2			LVLPR12[3:0]				
Access	R/W				R/W	R/W	R/W	R/W
Reset	0				0	0	0	0
Bit	15	14	13	12	11	10	9	8
	RRLVLEN1			LVLPR11[3:0]				
Access	R/W				R/W	R/W	R/W	R/W
Reset	0				0	0	0	0
Bit	7	6	5	4	3	2	1	0
	RRLVLEN0			LVLPR10[3:0]				
Access	R/W				R/W	R/W	R/W	R/W
Reset	0				0	0	0	0

### Bit 31 – RRLVLEN3: Level 3 Round-Robin Arbitration Enable

This bit controls which arbitration scheme is selected for DMA channels with priority level 3. For details on arbitration schemes, refer to [Arbitration](#).

Value	Description
0	Static arbitration scheme for channels with level 3 priority.
1	Round-robin arbitration scheme for channels with level 3 priority.

### Bits 27:24 – LVLPR13[3:0]: Level 3 Channel Priority Number

When round-robin arbitration is enabled (`PRICTRL0.RRLVLEN3=1`) for priority level 3, this register holds the channel number of the last DMA channel being granted access as the active channel with priority level 3.

When static arbitration is enabled (`PRICTRL0.RRLVLEN3=0`) for priority level 3, and the value of this bit group is non-zero, it will not affect the static priority scheme.

This bit group is not reset when round-robin arbitration gets disabled (`PRICTRL0.RRLVLEN3` written to '0').

**Bit 23 – RRLVLEN2: Level 2 Round-Robin Arbitration Enable**

This bit controls which arbitration scheme is selected for DMA channels with priority level 2. For details on arbitration schemes, refer to [Arbitration](#).

Value	Description
0	Static arbitration scheme for channels with level 2 priority.
1	Round-robin arbitration scheme for channels with level 2 priority.

**Bits 19:16 – LVLPR12[3:0]: Level 2 Channel Priority Number**

When round-robin arbitration is enabled (PRICTRL0.RRLVLEN2=1) for priority level 2, this register holds the channel number of the last DMA channel being granted access as the active channel with priority level 2.

When static arbitration is enabled (PRICTRL0.RRLVLEN2=0) for priority level 2, and the value of this bit group is non-zero, it will not affect the static priority scheme.

This bit group is not reset when round-robin arbitration gets disabled (PRICTRL0.RRLVLEN2 written to '0').

**Bit 15 – RRLVLEN1: Level 1 Round-Robin Scheduling Enable**

For details on arbitration schemes, refer to [Arbitration](#).

Value	Description
0	Static arbitration scheme for channels with level 1 priority.
1	Round-robin arbitration scheme for channels with level 1 priority.

**Bits 11:8 – LVLPR11[3:0]: Level 1 Channel Priority Number**

When round-robin arbitration is enabled (PRICTRL0.RRLVLEN1=1) for priority level 1, this register holds the channel number of the last DMA channel being granted access as the active channel with priority level 1.

When static arbitration is enabled (PRICTRL0.RRLVLEN1=0) for priority level 1, and the value of this bit group is non-zero, it will not affect the static priority scheme.

This bit group is not reset when round-robin arbitration gets disabled (PRICTRL0.RRLVLEN1 written to '0').

**Bit 7 – RRLVLEN0: Level 0 Round-Robin Scheduling Enable**

For details on arbitration schemes, refer to [Arbitration](#).

Value	Description
0	Static arbitration scheme for channels with level 0 priority.
1	Round-robin arbitration scheme for channels with level 0 priority.

**Bits 3:0 – LVLPR10[3:0]: Level 0 Channel Priority Number**

When round-robin arbitration is enabled (PRICTRL0.RRLVLEN0=1) for priority level 0, this register holds the channel number of the last DMA channel being granted access as the active channel with priority level 0.

When static arbitration is enabled (PRICTRL0.RRLVLEN0=0) for priority level 0, and the value of this bit group is non-zero, it will not affect the static priority scheme.

This bit group is not reset when round-robin arbitration gets disabled (PRICTRL0.RRLVLEN0 written to '0').

## 26.8.10 Interrupt Pending

This register allows the user to identify the lowest DMA channel with pending interrupt.

**Name:** INTPEND

**Offset:** 0x20 [ID-00001ece]

**Reset:** 0x0000

**Property:** -

	Bit	15	14	13	12	11	10	9	8
		PEND	BUSY	FERR			SUSP	TCMPL	TERR
Access		R	R	R			R/W	R/W	R/W
Reset		0	0	0			0	0	0
	Bit	7	6	5	4	3	2	1	0
						ID[3:0]			
Access						R/W	R/W	R/W	R/W
Reset						0	0	0	0

### Bit 15 – PEND: Pending

This bit will read '1' when the channel selected by Channel ID field (ID) is pending.

### Bit 14 – BUSY: Busy

This bit will read '1' when the channel selected by Channel ID field (ID) is busy.

### Bit 13 – FERR: Fetch Error

This bit will read '1' when the channel selected by Channel ID field (ID) fetched an invalid descriptor.

### Bit 10 – SUSP: Channel Suspend

This bit will read '1' when the channel selected by Channel ID field (ID) has pending Suspend interrupt.

Writing a '0' to this bit has no effect.

Writing a '1' to this bit will clear the Channel ID (ID) Suspend interrupt flag.

### Bit 9 – TCMPL: Transfer Complete

This bit will read '1' when the channel selected by Channel ID field (ID) has pending Transfer Complete interrupt.

Writing a '0' to this bit has no effect.

Writing a '1' to this bit will clear the Channel ID (ID) Transfer Complete interrupt flag.

### Bit 8 – TERR: Transfer Error

This bit is read one when the channel selected by Channel ID field (ID) has pending Transfer Error interrupt.

Writing a '0' to this bit has no effect.

Writing a '1' to this bit will clear the Channel ID (ID) Transfer Error interrupt flag.

### Bits 3:0 – ID[3:0]: Channel ID

These bits store the lowest channel number with pending interrupts. The number is valid if Suspend (SUSP), Transfer Complete (TCMPL) or Transfer Error (TERR) bits are set. The Channel ID field is

refreshed when a new channel (with channel number less than the current one) with pending interrupts is detected, or when the application clears the corresponding channel interrupt sources. When no pending channels interrupts are available, these bits will always return zero value when read.

When the bits are written, indirect access to the corresponding Channel Interrupt Flag register is enabled.

## 26.8.11 Interrupt Status

**Name:** INTSTATUS  
**Offset:** 0x24 [ID-00001ece]  
**Reset:** 0x00000000  
**Property:** -

Bit	31	30	29	28	27	26	25	24
Access								
Reset								
Bit	23	22	21	20	19	18	17	16
Access								
Reset								
Bit	15	14	13	12	11	10	9	8
Access								
Reset								
Bit	7	6	5	4	3	2	1	0
			CHINT <sub>n</sub>	CHINT <sub>n</sub>	CHINT <sub>n</sub>	CHINT <sub>n</sub>	CHINT <sub>n</sub>	CHINT <sub>n</sub>
Access			R	R	R	R	R	R
Reset			0	0	0	0	0	0

### Bits 5:0 – CHINT<sub>n</sub>: Channel n Pending Interrupt [n=5..0]

This bit is set when Channel n has a pending interrupt/the interrupt request is received.

This bit is cleared when the corresponding Channel n interrupts are disabled or the interrupts sources are cleared.

## 26.8.12 Busy Channels

**Name:** BUSYCH  
**Offset:** 0x28 [ID-00001ece]  
**Reset:** 0x00000000  
**Property:** -

Bit	31	30	29	28	27	26	25	24
	[Greyed out bits 31-24]							
Access								
Reset								
Bit	23	22	21	20	19	18	17	16
	[Greyed out bits 23-16]							
Access								
Reset								
Bit	15	14	13	12	11	10	9	8
	[Greyed out bits 15-8]							
Access								
Reset								
Bit	7	6	5	4	3	2	1	0
	[Greyed out bits 7-6]		BUSYCHn	BUSYCHn	BUSYCHn	BUSYCHn	BUSYCHn	BUSYCHn
Access			R	R	R	R	R	R
Reset			0	0	0	0	0	0

**Bits 5:0 – BUSYCHn: Busy Channel n [x=5..0]**

This bit is cleared when the channel trigger action for DMA channel n is complete, when a bus error for DMA channel n is detected, or when DMA channel n is disabled.

This bit is set when DMA channel n starts a DMA transfer.

**26.8.13 Pending Channels**

**Name:** PENDCH  
**Offset:** 0x2C [ID-00001ece]  
**Reset:** 0x00000000  
**Property:** -



Bit	31	30	29	28	27	26	25	24
Access								
Reset								
Bit	23	22	21	20	19	18	17	16
Access								
Reset								
Bit	15	14	13	12	11	10	9	8
Access								
Reset								
Bit	7	6	5	4	3	2	1	0
			PENDCH5	PENDCH4	PENDCH3	PENDCH2	PENDCH1	PENDCH0
Access			R	R	R	R	R	R
Reset			0	0	0	0	0	0

**Bits 0, 1, 2, 3, 4, 5 – PENDCH: Pending Channel n [n=5..0]**

This bit is cleared when trigger execution defined by channel trigger action settings for DMA channel n is started, when a bus error for DMA channel n is detected or when DMA channel n is disabled. For details on trigger action settings, refer to CHCTRLB.TRIGACT.

This bit is set when a transfer is pending on DMA channel n.

**26.8.14 Active Channel and Levels**

**Name:** ACTIVE  
**Offset:** 0x30 [ID-00001ece]  
**Reset:** 0x00000000  
**Property:** -

Bit	31	30	29	28	27	26	25	24
	BTCNT[15:8]							
Access	R	R	R	R	R	R	R	R
Reset	0	0	0	0	0	0	0	0
Bit	23	22	21	20	19	18	17	16
	BTCNT[7:0]							
Access	R	R	R	R	R	R	R	R
Reset	0	0	0	0	0	0	0	0
Bit	15	14	13	12	11	10	9	8
	ABUSY				ID[4:0]			
Access	R			R	R	R	R	R
Reset	0			0	0	0	0	0
Bit	7	6	5	4	3	2	1	0
					LVLEXx	LVLEXx	LVLEXx	LVLEXx
Access					R	R	R	R
Reset					0	0	0	0

**Bits 31:16 – BTCNT[15:0]: Active Channel Block Transfer Count**

These bits hold the 16-bit block transfer count of the ongoing transfer. This value is stored in the active channel and written back in the corresponding Write-Back channel memory location when the arbiter grants a new channel access. The value is valid only when the active channel active busy flag (ABUSY) is set.

**Bit 15 – ABUSY: Active Channel Busy**

This bit is cleared when the active transfer count is written back in the write-back memory section.  
 This bit is set when the next descriptor transfer count is read from the write-back memory section.

**Bits 12:8 – ID[4:0]: Active Channel ID**

These bits hold the channel index currently stored in the active channel registers. The value is updated each time the arbiter grants a new channel transfer access request.

**Bits 3,2,1,0 – LVLEXx: Level x Channel Trigger Request Executing [x=3..0]**

This bit is set when a level-x channel trigger request is executing or pending.  
 This bit is cleared when no request is pending or being executed.

**26.8.15 Descriptor Memory Section Base Address**

**Name:** BASEADDR  
**Offset:** 0x34 [ID-00001ece]  
**Reset:** 0x00000000  
**Property:** PAC Write-Protection, Enable-Protected

Bit	31	30	29	28	27	26	25	24
BASEADDR[31:24]								
Access	R/W	R/W	R/W	R/W	R/W	R/W	R/W	R/W
Reset	0	0	0	0	0	0	0	0
Bit	23	22	21	20	19	18	17	16
BASEADDR[23:16]								
Access	R/W	R/W	R/W	R/W	R/W	R/W	R/W	R/W
Reset	0	0	0	0	0	0	0	0
Bit	15	14	13	12	11	10	9	8
BASEADDR[15:8]								
Access	R/W	R/W	R/W	R/W	R/W	R/W	R/W	R/W
Reset	0	0	0	0	0	0	0	0
Bit	7	6	5	4	3	2	1	0
BASEADDR[7:0]								
Access	R/W	R/W	R/W	R/W	R/W	R/W	R/W	R/W
Reset	0	0	0	0	0	0	0	0

**Bits 31:0 – BASEADDR[31:0]: Descriptor Memory Base Address**

These bits store the Descriptor memory section base address. The value must be 128-bit aligned.

**26.8.16 Write-Back Memory Section Base Address**

**Name:** WRBADDR

**Offset:** 0x38 [ID-00001ece]

**Reset:** 0x00000000

**Property:** PAC Write-Protection, Enable-Protected

Bit	31	30	29	28	27	26	25	24
	WRBADDR[31:24]							
Access	R/W	R/W	R/W	R/W	R/W	R/W	R/W	R/W
Reset	0	0	0	0	0	0	0	0
Bit	23	22	21	20	19	18	17	16
	WRBADDR[23:16]							
Access	R/W	R/W	R/W	R/W	R/W	R/W	R/W	R/W
Reset	0	0	0	0	0	0	0	0
Bit	15	14	13	12	11	10	9	8
	WRBADDR[15:8]							
Access	R/W	R/W	R/W	R/W	R/W	R/W	R/W	R/W
Reset	0	0	0	0	0	0	0	0
Bit	7	6	5	4	3	2	1	0
	WRBADDR[7:0]							
Access	R/W	R/W	R/W	R/W	R/W	R/W	R/W	R/W
Reset	0	0	0	0	0	0	0	0

**Bits 31:0 – WRBADDR[31:0]: Write-Back Memory Base Address**

These bits store the Write-Back memory base address. The value must be 128-bit aligned.

### 26.8.17 Channel ID

**Name:** CHID  
**Offset:** 0x3F [ID-00001ece]  
**Reset:** 0x00  
**Property:** -

Bit	7	6	5	4	3	2	1	0
					ID[3:0]			
Access					R/W	R/W	R/W	R/W
Reset					0	0	0	0

**Bits 3:0 – ID[3:0]: Channel ID**

These bits define the channel number that will be affected by the channel registers (CH\*). Before reading or writing a channel register, the channel ID bit group must be written first.

### 26.8.18 Channel Control A

This register affects the DMA channel that is selected in the Channel ID register (CHID.ID).

**Name:** CHCTRLA  
**Offset:** 0x40 [ID-00001ece]  
**Reset:** 0x00  
**Property:** PAC Write-Protection, Enable-Protected

Bit	7	6	5	4	3	2	1	0
		RUNSTDBY					ENABLE	SWRST
Access	R	R/W	R	R	R	R	R/W	R/W
Reset	0	0	0	0	0	0	0	0

### Bit 6 – RUNSTDBY: Channel run in standby

This bit is used to keep the DMAC channel running in standby mode.

This bit is not enable-protected.

Value	Description
0	The DMAC channel is halted in standby.
1	The DMAC channel continues to run in standby.

### Bit 1 – ENABLE: Channel Enable

Writing a '0' to this bit during an ongoing transfer, the bit will not be cleared until the internal data transfer buffer is empty and the DMA transfer is aborted. The internal data transfer buffer will be empty once the ongoing burst transfer is completed.

Writing a '1' to this bit will enable the DMA channel.

This bit is not enable-protected.

Value	Description
0	DMA channel is disabled.
1	DMA channel is enabled.

### Bit 0 – SWRST: Channel Software Reset

Writing a '0' to this bit has no effect.

Writing a '1' to this bit resets the channel registers to their initial state. The bit can be set when the channel is disabled (ENABLE=0). Writing a '1' to this bit will be ignored as long as ENABLE=1. This bit is automatically cleared when the reset is completed.

Value	Description
0	There is no reset operation ongoing.
1	The reset operation is ongoing.

## 26.8.19 Channel Control B

This register affects the DMA channel that is selected in the Channel ID register (CHID.ID).

**Name:** CHCTRLB

**Offset:** 0x44 [ID-00001ece]

**Reset:** 0x00000000

**Property:** PAC Write-Protection, Enable-Protected

Bit	31	30	29	28	27	26	25	24
							CMD[1:0]	
Access							R/W	R/W
Reset							0	0
Bit	23	22	21	20	19	18	17	16
	TRIGACT[1:0]							
Access	R/W	R/W						
Reset	0	0						
Bit	15	14	13	12	11	10	9	8
			TRIGSRC[5:0]					
Access			R/W	R/W	R/W	R/W	R/W	R/W
Reset			0	0	0	0	0	0
Bit	7	6	5	4	3	2	1	0
		LVL[1:0]		EVOE	EVIE	EVACT[2:0]		
Access		R/W	R/W	R/W	R/W	R/W	R/W	R/W
Reset		0	0	0	0	0	0	0

### Bits 25:24 – CMD[1:0]: Software Command

These bits define the software commands. Refer to [Channel Suspend](#) and [Channel Resume and Next Suspend Skip](#).

These bits are not enable-protected.

CMD[1:0]	Name	Description
0x0	NOACT	No action
0x1	SUSPEND	Channel suspend operation
0x2	RESUME	Channel resume operation
0x3	-	Reserved

### Bits 23:22 – TRIGACT[1:0]: Trigger Action

These bits define the trigger action used for a transfer.

TRIGACT[1:0]	Name	Description
0x0	BLOCK	One trigger required for each block transfer
0x1	-	Reserved
0x2	BEAT	One trigger required for each beat transfer
0x3	TRANSACTION	One trigger required for each transaction

### Bits 13:8 – TRIGSRC[5:0]: Trigger Source

These bits define the peripheral trigger which is source of the transfer. For details on trigger selection and trigger modes, refer to [Transfer Triggers and Actions](#) and CHCTRLB.TRIGACT.

**Table 26-2. Peripheral Trigger Source**

Value	Name	Description
0x00	DISABLE	Only software/event triggers
0x01	-	Reserved
0x02	SERCOM0 RX	SERCOM0 RX Trigger
0x03	SERCOM0 TX	SERCOM0TX Trigger
0x04	SERCOM1 RX	SERCOM1 RX Trigger
0x05	SERCOM1 TX	SERCOM1 TX Trigger
0x06	SERCOM2 RX	SERCOM2 RX Trigger
0x07	SERCOM2 TX	SERCOM2 TX Trigger
0x08	SERCOM3 RX	SERCOM3 RX Trigger
0x09	SERCOM3 TX	SERCOM3 TX Trigger
0x0A	-	Reserved
0x0B	-	Reserved
0x0C	-	Reserved
0x0D	-	Reserved
0x0E	-	Reserved
0x0F	-	Reserved
0x10	TCC0 OVF	TCC0 Overflow Trigger
0x11	TCC0 MC0	TCC0 Match/Compare 0 Trigger
0x12	TCC0 MC1	TCC0 Match/Compare 1 Trigger
0x13	TCC0 MC2	TCC0 Match/Compare 2 Trigger
0x14	TCC0 MC3	TCC0 Match/Compare 3 Trigger
0x15	TCC1 OVF	TCC1 Overflow Trigger
0x16	TCC1 MC0	TCC1 Match/Compare 0 Trigger
0x17	TCC1 MC1	TCC1 Match/Compare 1 Trigger
0x18	TCC2 OVF	TCC2 Overflow Trigger
0x19	TCC2 MC0	TCC2 Match/Compare 0 Trigger
0x1A	TCC2 MC1	TCC2 Match/Compare 1 Trigger
0x1B	TC0 OVF	TC0 Overflow Trigger
0x1C	TC0 MC0	TC0 Match/Compare 0 Trigger
0x1D	TC0 MC1	TC0 Match/Compare 1 Trigger
0x1E	TC1 OVF	TC1 Overflow Trigger
0x1F	TC1 MC0	TC1 Match/Compare 0 Trigger

Value	Name	Description
0x20	TC1 MC1	TC1 Match/Compare 1 Trigger
0x21	TC2 OVF	TC2 Overflow Trigger
0x22	TC2 MC0	TC2 Match/Compare 0 Trigger
0x23	TC2 MC1	TC2 Match/Compare 1 Trigger
0x24	TC3 OVF	TC3 Overflow Trigger
0x25	TC3 MC0	TC3 Match/Compare 0 Trigger
0x26	TC3 MC1	TC3 Match/Compare 1 Trigger
0x27	TC4 OVF	TC4 Overflow Trigger
0x28	TC4 MC0	TC4 Match/Compare 0 Trigger
0x29	TC4 MC1	TC4 Match/Compare 1 Trigger
0x2A	ADC0 RESRDY	ADC0 Result Ready Trigger
0x2E	PTC EOC	PTC End of Conversion Trigger
0x2F	PTC WCOMP	PTC Window Compare Trigger
0x30	PTC SEQ	PTC Sequence Trigger
0x31	SERCOM6 RX	SERCOM6 RX Trigger
0x32	SERCOM6 TX	SERCOM6 TX Trigger
0x33	SERCOM7 RX	SERCOM6 RX Trigger
0x34	SERCOM7 TX	SERCOM6 TX Trigger
0x35	TC5 OVF	TC5 Overflow Trigger
0x36	TC5 MC0	TC5 Match/Compare 0 Trigger
0x37	TC5 MC1	TC5 Match/Compare 1 Trigger
0x38	TC6 OVF	TC6 Overflow Trigger
0x39	TC6 MC0	TC6 Match/Compare 0 Trigger
0x3A	TC6 MC1	TC6 Match/Compare 1 Trigger
0x3B	TC7 OVF	TC7 Overflow Trigger
0x3C	TC7 MC0	TC7 Match/Compare 0 Trigger
0x3D	TC7MC1	TC7 Match/Compare 1 Trigger

**Bits 6:5 – LVL[1:0]: Channel Arbitration Level**

These bits define the arbitration level used for the DMA channel, where a high level has priority over a low level. For further details on arbitration schemes, refer to [Arbitration](#).

These bits are not enable-protected.



TRIGACT[1:0]	Name	Description
0x0	LVL0	Channel Priority Level 0
0x1	LVL1	Channel Priority Level 1
0x2	LVL2	Channel Priority Level 2
0x3	LVL3	Channel Priority Level 3

#### Bit 4 – EVOE: Channel Event Output Enable

This bit indicates if the Channel event generation is enabled. The event will be generated for every condition defined in the descriptor Event Output Selection ([BTCTRL.EVOSEL](#)).

This bit is available only for the least significant DMA channels. Refer to table: *User Multiplexer Selection* and *Event Generator Selection* of the Event System for details.

Value	Description
0	Channel event generation is disabled.
1	Channel event generation is enabled.

#### Bit 3 – EVIE: Channel Event Input Enable

This bit is available only for the least significant DMA channels. Refer to table: *User Multiplexer Selection* and *Event Generator Selection* of the Event System for details.

Value	Description
0	Channel event action will not be executed on any incoming event.
1	Channel event action will be executed on any incoming event.

#### Bits 2:0 – EVACT[2:0]: Event Input Action

These bits define the event input action, as shown below. The action is executed only if the corresponding EVIE bit in CHCTRLB register of the channel is set.

These bits are available only for the least significant DMA channels. Refer to table: *User Multiplexer Selection* and *Event Generator Selection* of the Event System for details.

EVACT[2:0]	Name	Description
0x0	NOACT	No action
0x1	TRIG	Normal Transfer and Conditional Transfer on Strobe trigger
0x2	CTRIG	Conditional transfer trigger
0x3	CBLOCK	Conditional block transfer
0x4	SUSPEND	Channel suspend operation
0x5	RESUME	Channel resume operation
0x6	SSKIP	Skip next block suspend action
0x7	-	Reserved

### 26.8.20 Channel Interrupt Enable Clear

This register allows the user to disable an interrupt without doing a read-modify-write operation. Changes in this register will also be reflected in the Channel Interrupt Enable Set (CHINTENSET) register.

This register affects the DMA channel that is selected in the Channel ID register (CHID.ID).

**Name:** CHINTENCLR  
**Offset:** 0x4C [ID-00001ece]  
**Reset:** 0x00  
**Property:** PAC Write-Protection

	Bit	7	6	5	4	3	2	1	0
							SUSP	TCMPL	TERR
Access							R/W	R/W	R/W
Reset							0	0	0

### Bit 2 – SUSP: Channel Suspend Interrupt Enable

Writing a '0' to this bit has no effect.

Writing a '1' to this bit will clear the Channel Suspend Interrupt Enable bit, which disables the Channel Suspend interrupt.

Value	Description
0	The Channel Suspend interrupt is disabled.
1	The Channel Suspend interrupt is enabled.

### Bit 1 – TCMPL: Channel Transfer Complete Interrupt Enable

Writing a '0' to this bit has no effect.

Writing a '1' to this bit will clear the Channel Transfer Complete Interrupt Enable bit, which disables the Channel Transfer Complete interrupt.

Value	Description
0	The Channel Transfer Complete interrupt is disabled. When block action is set to none, the TCMPL flag will not be set when a block transfer is completed.
1	The Channel Transfer Complete interrupt is enabled.

### Bit 0 – TERR: Channel Transfer Error Interrupt Enable

Writing a '0' to this bit has no effect.

Writing a '1' to this bit will clear the Channel Transfer Error Interrupt Enable bit, which disables the Channel Transfer Error interrupt.

Value	Description
0	The Channel Transfer Error interrupt is disabled.
1	The Channel Transfer Error interrupt is enabled.

## 26.8.21 Channel Interrupt Enable Set

This register allows the user to enable an interrupt without doing a read-modify-write operation. Changes in this register will also be reflected in the Channel Interrupt Enable Clear (CHINTENCLR) register. This register affects the DMA channel that is selected in the Channel ID register (CHID.ID).

**Name:** CHINTENSET  
**Offset:** 0x4D [ID-00001ece]  
**Reset:** 0x00  
**Property:** PAC Write-Protection

Bit	7	6	5	4	3	2	1	0
						SUSP	TCMPL	TERR
Access						R/W	R/W	R/W
Reset						0	0	0

**Bit 2 – SUSP: Channel Suspend Interrupt Enable**

Writing a '0' to this bit has no effect.

Writing a '1' to this bit will set the Channel Suspend Interrupt Enable bit, which enables the Channel Suspend interrupt.

Value	Description
0	The Channel Suspend interrupt is disabled.
1	The Channel Suspend interrupt is enabled.

**Bit 1 – TCMPL: Channel Transfer Complete Interrupt Enable**

Writing a '0' to this bit has no effect.

Writing a '1' to this bit will set the Channel Transfer Complete Interrupt Enable bit, which enables the Channel Transfer Complete interrupt.

Value	Description
0	The Channel Transfer Complete interrupt is disabled.
1	The Channel Transfer Complete interrupt is enabled.

**Bit 0 – TERR: Channel Transfer Error Interrupt Enable**

Writing a '0' to this bit has no effect.

Writing a '1' to this bit will set the Channel Transfer Error Interrupt Enable bit, which enables the Channel Transfer Error interrupt.

Value	Description
0	The Channel Transfer Error interrupt is disabled.
1	The Channel Transfer Error interrupt is enabled.

**26.8.22 Channel Interrupt Flag Status and Clear**

This register affects the DMA channel that is selected in the Channel ID register (CHID.ID).

**Name:** CHINTFLAG  
**Offset:** 0x4E [ID-00001ece]  
**Reset:** 0x00  
**Property:** -

Bit	7	6	5	4	3	2	1	0
						SUSP	TCMPL	TERR
Access						R/W	R/W	R/W
Reset						0	0	0

**Bit 2 – SUSP: Channel Suspend**

This flag is cleared by writing a '1' to it.

This flag is set when a block transfer with suspend block action is completed, when a software suspend command is executed, when a suspend event is received or when an invalid descriptor is fetched by the DMA.

Writing a '0' to this bit has no effect.

Writing a '1' to this bit will clear the Channel Suspend interrupt flag for the corresponding channel.

For details on available software commands, refer to CHCTRLB.CMD.

For details on available event input actions, refer to CHCTRLB.EVACT.

For details on available block actions, refer to BTCTRL.BLOCKACT.

### Bit 1 – TC MPL: Channel Transfer Complete

This flag is cleared by writing a '1' to it.

This flag is set when a block transfer is completed and the corresponding interrupt block action is enabled.

Writing a '0' to this bit has no effect.

Writing a '1' to this bit will clear the Transfer Complete interrupt flag for the corresponding channel.

### Bit 0 – TERR: Channel Transfer Error

This flag is cleared by writing a '1' to it.

This flag is set when a bus error is detected during a beat transfer or when the DMAC fetches an invalid descriptor.

Writing a '0' to this bit has no effect.

Writing a '1' to this bit will clear the Transfer Error interrupt flag for the corresponding channel.

## 26.8.23 Channel Status

This register affects the DMA channel that is selected in the Channel ID register (CHID.ID).

**Name:** CHSTATUS  
**Offset:** 0x4F [ID-00001ece]  
**Reset:** 0x00  
**Property:** -

	7	6	5	4	3	2	1	0
						FERR	BUSY	PEND
Access						R	R	R
Reset						0	0	0

### Bit 2 – FERR: Channel Fetch Error

This bit is cleared when a software resume command is executed.

This bit is set when an invalid descriptor is fetched.

### Bit 1 – BUSY: Channel Busy

This bit is cleared when the channel trigger action is completed, when a bus error is detected or when the channel is disabled.

This bit is set when the DMA channel starts a DMA transfer.

### **Bit 0 – PEND: Channel Pending**

This bit is cleared when the channel trigger action is started, when a bus error is detected or when the channel is disabled. For details on trigger action settings, refer to CHCTRLB.TRIGACT.

This bit is set when a transfer is pending on the DMA channel, as soon as the transfer request is received.

## 26.9 Register Summary - SRAM

Offset	Name	Bit Pos.							
0x00	BTCTRL	7:0				BLOCKACT[1:0]		EVOSEL[1:0]	VALID
0x01		15:8	STEPSIZE[2:0]		STEPSEL	DSTINC	SRCINC	BEATSIZE[1:0]	
0x02	BTCNT	7:0	BTCNT[7:0]						
0x03		15:8	BTCNT[15:8]						
0x04	SRCADDR	7:0	SRCADDR[7:0]						
0x05		15:8	SRCADDR[15:8]						
0x06		23:16	SRCADDR[23:16]						
0x07		31:24	SRCADDR[31:24]						
0x08	DSTADDR	7:0	DSTADDR[7:0]						
0x09		15:8	DSTADDR[15:8]						
0x0A		23:16	DSTADDR[23:16]						
0x0B		31:24	DSTADDR[31:24]						
0x0C	DESCADDR	7:0	DESCADDR[7:0]						
0x0D		15:8	DESCADDR[15:8]						
0x0E		23:16	DESCADDR[23:16]						
0x0F		31:24	DESCADDR[31:24]						

## 26.10 Register Description - SRAM

Registers can be 8, 16, or 32 bits wide. Atomic 8-, 16- and 32-bit accesses are supported. In addition, the 8-bit quarters and 16-bit halves of a 32-bit register, and the 8-bit halves of a 16-bit register can be accessed directly.

Some registers are optionally write-protected by the Peripheral Access Controller (PAC). Optional PAC write-protection is denoted by the "PAC Write-Protection" property in each individual register description. For details, refer to [Register Access Protection](#).

Some registers are enable-protected, meaning they can only be written when the peripheral is disabled. Enable-protection is denoted by the "Enable-Protected" property in each individual register description.

### 26.10.1 Block Transfer Control

The BTCTRL register offset is relative to (BASEADDR or WRBADDR) + Channel Number \* 0x10

**Name:** BTCTRL  
**Offset:** 0x00 [ID-00001ece]  
**Reset:** -  
**Property:** -

Bit	15	14	13	12	11	10	9	8
	STEPSSIZE[2:0]			STEPSEL	DSTINC	SRCINC	BEATSIZE[1:0]	
Access								
Reset								
Bit	7	6	5	4	3	2	1	0
				BLOCKACT[1:0]		EVOSEL[1:0]		VALID
Access								
Reset								

### Bits 15:13 – STEPSSIZE[2:0]: Address Increment Step Size

These bits select the address increment step size. The setting apply to source or destination address, depending on STEPSEL setting.

Value	Name	Description
0x0	X1	Next ADDR = ADDR + (Beat size in byte) * 1
0x1	X2	Next ADDR = ADDR + (Beat size in byte) * 2
0x2	X4	Next ADDR = ADDR + (Beat size in byte) * 4
0x3	X8	Next ADDR = ADDR + (Beat size in byte) * 8
0x4	X16	Next ADDR = ADDR + (Beat size in byte) * 16
0x5	X32	Next ADDR = ADDR + (Beat size in byte) * 32
0x6	X64	Next ADDR = ADDR + (Beat size in byte) * 64
0x7	X128	Next ADDR = ADDR + (Beat size in byte) * 128

### Bit 12 – STEPSEL: Step Selection

This bit selects if source or destination addresses are using the step size settings.

Value	Name	Description
0x0	DST	Step size settings apply to the destination address
0x1	SRC	Step size settings apply to the source address

### Bit 11 – DSTINC: Destination Address Increment Enable

Writing a '0' to this bit will disable the destination address incrementation. The address will be kept fixed during the data transfer.

Writing a '1' to this bit will enable the destination address incrementation. By default, the destination address is incremented by 1. If the STEPSEL bit is cleared, flexible step-size settings are available in the STEPSSIZE register.

Value	Description
0	The Destination Address Increment is disabled.
1	The Destination Address Increment is enabled.

### Bit 10 – SRCINC: Source Address Increment Enable

Writing a '0' to this bit will disable the source address incrementation. The address will be kept fixed during the data transfer.

Writing a '1' to this bit will enable the source address incrementation. By default, the source address is incremented by 1. If the STEPSEL bit is set, flexible step-size settings are available in the STEPSSIZE register.

Value	Description
0	The Source Address Increment is disabled.
1	The Source Address Increment is enabled.

### Bits 9:8 – BEATSIZE[1:0]: Beat Size

These bits define the size of one beat. A beat is the size of one data transfer bus access, and the setting apply to both read and write accesses.

Value	Name	Description
0x0	BYTE	8-bit bus transfer
0x1	HWORDB	16-bit bus transfer
0x2	WORD	32-bit bus transfer
other		Reserved

### Bits 4:3 – BLOCKACT[1:0]: Block Action

These bits define what actions the DMAC should take after a block transfer has completed.

BLOCKACT[1:0]	Name	Description
0x0	NOACT	Channel will be disabled if it is the last block transfer in the transaction
0x1	INT	Channel will be disabled if it is the last block transfer in the transaction and block interrupt
0x2	SUSPEND	Channel suspend operation is completed
0x3	BOTH	Both channel suspend operation and block interrupt

### Bits 2:1 – EVOSEL[1:0]: Event Output Selection

These bits define the event output selection.

EVOSEL[1:0]	Name	Description
0x0	DISABLE	Event generation disabled
0x1	BLOCK	Event strobe when block transfer complete
0x2		Reserved
0x3	BEAT	Event strobe when beat transfer complete

### Bit 0 – VALID: Descriptor Valid

Writing a '0' to this bit in the Descriptor or Write-Back memory will suspend the DMA channel operation when fetching the corresponding descriptor.

The bit is automatically cleared in the Write-Back memory section when channel is aborted, when an error is detected during the block transfer, or when the block transfer is completed.

Value	Description
0	The descriptor is not valid.
1	The descriptor is valid.

## 26.10.2 Block Transfer Count

The BTCNT register offset is relative to (BASEADDR or WRBADDR) + Channel Number \* 0x10



**Name:** BTCNT  
**Offset:** 0x02 [ID-00001ece]  
**Reset:** -  
**Property:** -

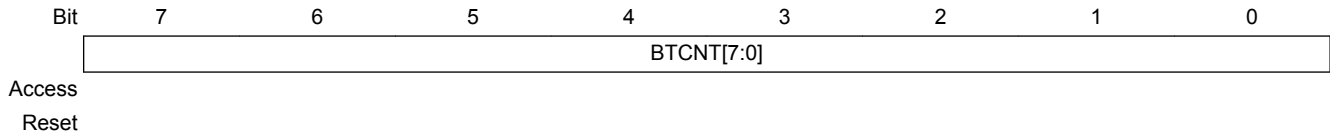
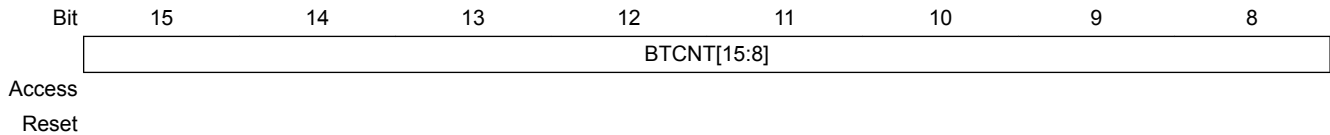

**Bits 15:0 – BTCNT[15:0]: Block Transfer Count**

This bit group holds the 16-bit block transfer count.

During a transfer, the internal counter value is decremented by one after each beat transfer. The internal counter is written to the corresponding write-back memory section for the DMA channel when the DMA channel loses priority, is suspended or gets disabled. The DMA channel can be disabled by a complete transfer, a transfer error or by software.

**26.10.3 Block Transfer Source Address**

The SRCADDR register offset is relative to (BASEADDR or WRBADDR) + Channel Number \* 0x10

**Name:** SRCADDR  
**Offset:** 0x04 [ID-00001ece]  
**Reset:** -  
**Property:** -



**Bits 31:0 – SRCADDR[31:0]: Transfer Source Address**

This bit group holds the source address corresponding to the last beat transfer address in the block transfer.

**26.10.4 Block Transfer Destination Address**

The DSTADDR register offset is relative to (BASEADDR or WRBADDR) + Channel Number \* 0x10

**Name:** DSTADDR  
**Offset:** 0x08 [ID-00001ece]  
**Reset:** -  
**Property:** -



**Bits 31:0 – DSTADDR[31:0]: Transfer Destination Address**

This bit group holds the destination address corresponding to the last beat transfer address in the block transfer.

**26.10.5 Next Descriptor Address**

The DESCADDR register offset is relative to (BASEADDR or WRBADDR) + Channel Number \* 0x10

**Name:** DESCADDR  
**Offset:** 0x0C [ID-00001ece]  
**Reset:** -  
**Property:** -



**Bits 31:0 – DESCADDR[31:0]: Next Descriptor Address**

This bit group holds the SRAM address of the next descriptor. The value must be 128-bit aligned. If the value of this SRAM register is 0x00000000, the transaction will be terminated when the DMAC tries to load the next transfer descriptor.

## 27. EIC – External Interrupt Controller

### 27.1 Overview

The External Interrupt Controller (EIC) allows external pins to be configured as interrupt lines. Each interrupt line can be individually masked and can generate an interrupt on rising, falling, or both edges, or on high or low levels. Each external pin has a configurable filter to remove spikes. Each external pin can also be configured to be asynchronous in order to wake up the device from sleep modes where all clocks have been disabled. External pins can also generate an event.

A separate non-maskable interrupt (NMI) is also supported. It has properties similar to the other external interrupts, but is connected to the NMI request of the CPU, enabling it to interrupt any other interrupt mode.

### 27.2 Features

- Up to 32 external pins (EXTINTx), plus one non-maskable pin (NMI)
- Dedicated, individually maskable interrupt for each pin
- Interrupt on rising, falling, or both edges
- Synchronous or asynchronous edge detection mode
- Interrupt on high or low levels
- Asynchronous interrupts for sleep modes without clock
- Filtering of external pins
- Event generation from EXTINTx

### 27.3 Block Diagram

Figure 27-1. EIC Block Diagram

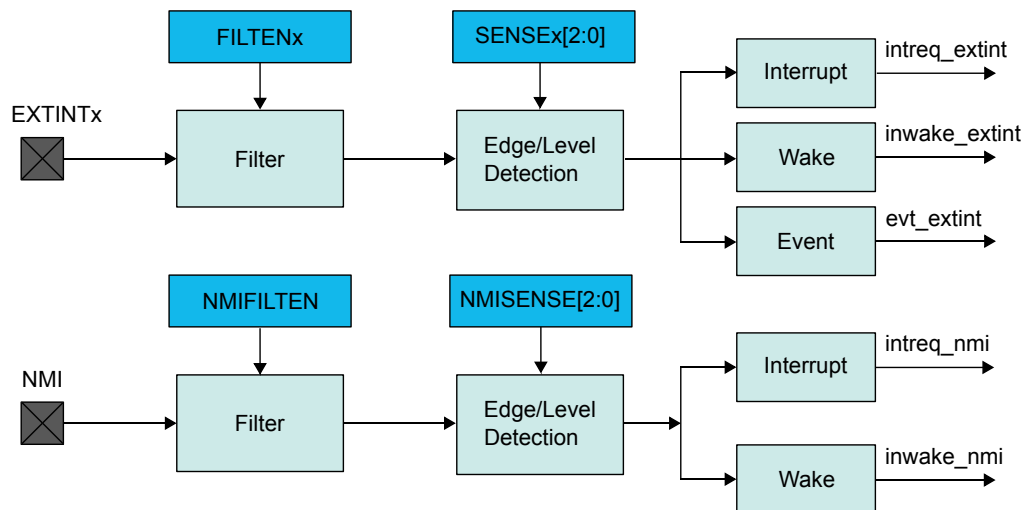

## 27.4 Signal Description

Signal Name	Type	Description
EXTINT[31..0]	Digital Input	External interrupt pin
NMI	Digital Input	Non-maskable interrupt pin

One signal may be available on several pins.

### Related Links

[I/O Multiplexing and Considerations](#)

## 27.5 Product Dependencies

In order to use this peripheral, other parts of the system must be configured correctly, as described below.

### 27.5.1 I/O Lines

Using the EIC's I/O lines requires the I/O pins to be configured.

#### Related Links

[PORT - I/O Pin Controller](#)

### 27.5.2 Power Management

All interrupts are available down to STANDBY sleep mode, but the EIC can be configured to automatically mask some interrupts in order to prevent device wake-up.

The EIC will continue to operate in any sleep mode where the selected source clock is running. The EIC's interrupts can be used to wake up the device from sleep modes. Events connected to the Event System can trigger other operations in the system without exiting sleep modes.

#### Related Links

[PM – Power Manager](#)

### 27.5.3 Clocks

The EIC bus clock (CLK\_EIC\_APB) can be enabled and disabled by the Main Clock Controller, the default state of CLK\_EIC\_APB can be found in the Peripheral Clock Masking section.

Some optional functions need a peripheral clock, which can either be a generic clock (GCLK\_EIC, for wider frequency selection) or a Ultra Low Power 32KHz clock (CLK\_ULP32K, for highest power efficiency). One of the clock sources must be configured and enabled before using the peripheral:

GCLK\_EIC is configured and enabled in the Generic Clock Controller.

CLK\_ULP32K is provided by the internal ultra-low-power (OSCULP32K) oscillator in the OSC32KCTRL module.

Both GCLK\_EIC and CLK\_ULP32K are asynchronous to the user interface clock (CLK\_EIC\_APB). Due to this asynchronicity, writes to certain registers will require synchronization between the clock domains. Refer to [Synchronization](#) for further details.

#### Related Links

[MCLK – Main Clock](#)

[Peripheral Clock Masking](#)

[GCLK - Generic Clock Controller](#)

## [OSC32KCTRL – 32KHz Oscillators Controller](#)

### **27.5.4 DMA**

Not applicable.

### **27.5.5 Interrupts**

There are two interrupt request lines, one for the external interrupts (EXTINT) and one for non-maskable interrupt (NMI).

The EXTINT interrupt request line is connected to the interrupt controller. Using the EIC interrupt requires the interrupt controller to be configured first.

The NMI interrupt request line is also connected to the interrupt controller, but does not require the interrupt to be configured.

#### **Related Links**

[Nested Vector Interrupt Controller](#)

### **27.5.6 Events**

The events are connected to the Event System. Using the events requires the Event System to be configured first.

#### **Related Links**

[EVSYS – Event System](#)

### **27.5.7 Debug Operation**

When the CPU is halted in debug mode, the EIC continues normal operation. If the EIC is configured in a way that requires it to be periodically serviced by the CPU through interrupts or similar, improper operation or data loss may result during debugging.

### **27.5.8 Register Access Protection**

All registers with write-access can be write-protected optionally by the Peripheral Access Controller (PAC), except for the following registers:

- Interrupt Flag Status and Clear register (INTFLAG)
- Non-Maskable Interrupt Flag Status and Clear register (NMIFLAG)

Optional write-protection by the Peripheral Access Controller (PAC) is denoted by the "PAC Write-Protection" property in each individual register description.

PAC write-protection does not apply to accesses through an external debugger.

#### **Related Links**

[PAC - Peripheral Access Controller](#)

### **27.5.9 Analog Connections**

Not applicable.

## **27.6 Functional Description**

### **27.6.1 Principle of Operation**

The EIC detects edge or level condition to generate interrupts to the CPU interrupt controller or events to the Event System. Each external interrupt pin (EXTINT) can be filtered using majority vote filtering, clocked by GCLK\_EIC or by CLK\_ULP32K.

## Related Links

[External Pin Processing](#)

## 27.6.2 Basic Operation

### 27.6.2.1 Initialization

The EIC must be initialized in the following order:

1. Enable CLK\_EIC\_APB
2. If required, configure the NMI by writing the Non-Maskable Interrupt Control register ([NMICTRL](#))
3. When the NMI is used or synchronous edge detection or filtering are required, enable GCLK\_EIC or CLK\_ULP32K.  
GCLK\_EIC is used when a frequency higher than 32KHz is required for filtering, CLK\_ULP32K is recommended when power consumption is the priority. For CLK\_ULP32K write a '1' to the Clock Selection bit in the Control A register ([CTRLA.CKSEL](#)). Optionally, enable the asynchronous mode.
4. Configure the EIC input sense and filtering by writing the Configuration n register ([CONFIG0](#), [CONFIG1](#), [CONFIG2](#), [CONFIG3](#)).
5. Enable the EIC.

The following bits are enable-protected, meaning that it can only be written when the EIC is disabled ([CTRLA.ENABLE=0](#)):

- Clock Selection bit in Control A register ([CTRLA.CKSEL](#))

The following registers are enable-protected:

- Event Control register ([EVCTRL](#))
- Configuration n register ([CONFIG0](#), [CONFIG1](#)...)
- External Interrupt Asynchronous Mode register ([ASYNCH](#))

Enable-protected bits in the [CTRLA](#) register can be written at the same time when setting [CTRLA.ENABLE](#) to '1', but not at the same time as [CTRLA.ENABLE](#) is being cleared.

Enable-protection is denoted by the "Enable-Protected" property in the register description.

### 27.6.2.2 Enabling, Disabling, and Resetting

The EIC is enabled by writing a '1' the Enable bit in the Control A register ([CTRLA.ENABLE](#)). The EIC is disabled by writing [CTRLA.ENABLE](#) to '0'.

The EIC is reset by setting the Software Reset bit in the Control register ([CTRLA.SWRST](#)). All registers in the EIC will be reset to their initial state, and the EIC will be disabled.

Refer to the [CTRLA](#) register description for details.

## 27.6.3 External Pin Processing

Each external pin can be configured to generate an interrupt/event on edge detection (rising, falling or both edges) or level detection (high or low). The sense of external interrupt pins is configured by writing the Input Sense x bits in the Config n register ([CONFIG0](#), [CONFIG1](#), [CONFIG2](#), [CONFIG3](#).SENSE<sub>x</sub>). The corresponding interrupt flag ([INTFLAG.EXTINT\[x\]](#)) in the Interrupt Flag Status and Clear register ([INTFLAG](#)) is set when the interrupt condition is met.

When the interrupt flag has been cleared in edge-sensitive mode, [INTFLAG.EXTINT\[x\]](#) will only be set if a new interrupt condition is met. In level-sensitive mode, when interrupt has been cleared, [INTFLAG.EXTINT\[x\]](#) will be set immediately if the EXTINT<sub>x</sub> pin still matches the interrupt condition.

Each external pin can be filtered by a majority vote filtering, clocked by GCLK\_EIC or CLK\_ULP32K. Filtering is enabled if bit Filter Enable x in the Configuration n register ([CONFIG0](#), [CONFIG1](#), [CONFIG2](#),



**CONFIG3.FILTENx** is written to '1'. The majority vote filter samples the external pin three times with GCLK\_EIC or CLK\_ULP32K and outputs the value when two or more samples are equal.

**Table 27-1. Majority Vote Filter**

Samples [0, 1, 2]	Filter Output
[0,0,0]	0
[0,0,1]	0
[0,1,0]	0
[0,1,1]	1
[1,0,0]	0
[1,0,1]	1
[1,1,0]	1
[1,1,1]	1

When an external interrupt is configured for level detection and when filtering is disabled, detection is done asynchronously. Asynchronous detection does not require GCLK\_EIC or CLK\_ULP32K, but interrupt and events can still be generated.

If filtering or edge detection is enabled, the EIC automatically requests GCLK\_EIC or CLK\_ULP32K to operate. The selection between these two clocks is done by writing the Clock Selection bits in the Control A register (**CTRLA.CKSEL**). GCLK\_EIC must be enabled in the GCLK module. In these modes the external pin is sampled at the EIC clock rate, thus pulses with duration lower than two EIC clock periods may not be properly detected.

**Figure 27-2. Interrupt Detection Latency by modes (Rising Edge)**



The detection latency depends on the detection mode.

**Table 27-2. Interrupt Latency**

Detection mode	Latency (worst case)
Level without filter	Five CLK_EIC_APB periods
Level with filter	Four GCLK_EIC/CLK_ULP32K periods + five CLK_EIC_APB periods
Edge without filter	Four GCLK_EIC/CLK_ULP32K periods + five CLK_EIC_APB periods
Edge with filter	Six GCLK_EIC/CLK_ULP32K periods + five CLK_EIC_APB periods

## Related Links

[GCLK - Generic Clock Controller](#)

## 27.6.4 Additional Features

### 27.6.4.1 Non-Maskable Interrupt (NMI)

The non-maskable interrupt pin can also generate an interrupt on edge or level detection, but it is configured with the dedicated NMI Control register (NMICTRL). To select the sense for NMI, write to the NMISENSE bit group in the NMI Control register (NMICTRL.NMISENSE). NMI filtering is enabled by writing a '1' to the NMI Filter Enable bit (NMICTRL.NMIFILTEN).

If edge detection or filtering is required, enable GCLK\_EIC or CLK\_ULP32K.

NMI detection is enabled only by the NMICTRL.NMISENSE value, and the EIC is not required to be enabled.

When an NMI is detected, the non-maskable interrupt flag in the NMI Flag Status and Clear register is set (NMIFLAG.NMI). NMI interrupt generation is always enabled, and NMIFLAG.NMI generates an interrupt request when set.

### 27.6.4.2 Asynchronous Edge Detection Mode

The EXTINT edge detection can be operated synchronously or asynchronously, selected by the Asynchronous Control Mode bit for external pin x in the External Interrupt Asynchronous Mode register ([ASYNCH.ASYNCH\[x\]](#)). The EIC edge detection is operated synchronously when the Asynchronous Control Mode bit ([ASYNCH.ASYNCH\[x\]](#)) is '0' (default value). It is operated asynchronously when [ASYNCH.ASYNCH\[x\]](#) is written to '1'.

In *Synchronous Edge Detection Mode*, the external interrupt (EXTINT) or the non-maskable interrupt (NMI) pins are sampled using the EIC clock as defined by the Clock Selection bit in the Control A register ([CTRLA.CKSEL](#)). The External Interrupt flag (INTFLAG.EXTINT[x]) or Non-Maskable Interrupt flag (NMIFLAG.NMI) is set when the last sampled state of the pin differs from the previously sampled state. In this mode, the EIC clock is required.

The Synchronous Edge Detection Mode can be used in Idle and Standby sleep modes.

In *Asynchronous Edge Detection Mode*, the external interrupt (EXTINT) pins or the non-maskable interrupt (NMI) pins set the External Interrupt flag or Non-Maskable Interrupt flag (INTFLAG.EXTINT[x] or NMIFLAG) directly. In this mode, the EIC clock is not requested.

The asynchronous edge detection mode can be used in Idle and Standby sleep modes.

## 27.6.5 DMA Operation

Not applicable.

## 27.6.6 Interrupts

The EIC has the following interrupt sources:

- External interrupt pins (EXTINTx). See [Basic Operation](#).
- Non-maskable interrupt pin (NMI). See [Additional Features](#).

Each interrupt source has an associated interrupt flag. The interrupt flag in the Interrupt Flag Status and Clear register (INTFLAG) is set when an interrupt condition occurs (NMIFLAG for NMI). Each interrupt, except NMI, can be individually enabled by setting the corresponding bit in the Interrupt Enable Set register (INTENSET=1), and disabled by setting the corresponding bit in the Interrupt Enable Clear register (INTENCLR=1).

An interrupt request is generated when the interrupt flag is set and the corresponding interrupt is enabled. The interrupt request remains active until the interrupt flag is cleared, the interrupt is disabled, or the EIC is reset. See the INTFLAG register for details on how to clear interrupt flags. The EIC has one common interrupt request line for all the interrupt sources, and one interrupt request line for the NMI. The user must read the INTFLAG (or NMIFLAG) register to determine which interrupt condition is present.

**Note:** Interrupts must be globally enabled for interrupt requests to be generated.

**Note:** If an external interrupts (EXTINT) is common on two or more I/O pins, only one will be active (the first one programmed).

## Related Links

[Processor and Architecture](#)

### 27.6.7 Events

The EIC can generate the following output events:

- External event from pin (EXTINTx).

Setting an Event Output Control register (EVCTRL.EXTINTEO) enables the corresponding output event. Clearing this bit disables the corresponding output event. Refer to *Event System* for details on configuring the Event System.

When the condition on pin EXTINTx matches the configuration in the CONFIGn register, the corresponding event is generated, if enabled.

## Related Links

[EVSYS – Event System](#)

### 27.6.8 Sleep Mode Operation

In sleep modes, an EXTINTx pin can wake up the device if the corresponding condition matches the configuration in [CONFIG0](#), [CONFIG1](#), [CONFIG2](#), [CONFIG3](#) register, and the corresponding bit in the Interrupt Enable Set register ([INTENSET](#)) is written to '1'.

**Figure 27-3. Wake-up Operation Example (High-Level Detection, No Filter, Interrupt Enable Set)**



### 27.6.9 Synchronization

Due to asynchronicity between the main clock domain and the peripheral clock domains, some registers need to be synchronized when written or read.

The following bits are synchronized when written:

- Software Reset bit in control register ([CTRLA.SWRST](#))
- Enable bit in control register ([CTRLA.ENABLE](#))

Required write-synchronization is denoted by the "Write-Synchronized" property in the register description.

27.7 Register Summary

Offset	Name	Bit Pos.								
0x00	CTRLA	7:0				CKSEL			ENABLE	SWRST
0x01	NMICTRL	7:0				NMIASYNCH	NMIFILTEN	NMISENSE[2:0]		
0x02	NMIFLAG	7:0								NMI
0x03		15:8								
0x04	SYNCBUSY	7:0							ENABLE	SWRST
0x05		15:8								
0x06		23:16								
0x07		31:24								
0x08	EVCTRL	7:0	EXTINTEO[7:0]							
0x09		15:8	EXTINTEO[15:8]							
0x0A		23:16	EXTINTEO[23:16]							
0x0B		31:24	EXTINTEO[31:24]							
0x0C	INTENCLR	7:0	EXTINT[7:0]							
0x0D		15:8	EXTINT[15:8]							
0x0E		23:16	EXTINT[23:16]							
0x0F		31:24	EXTINT[31:24]							
0x10	INTENSET	7:0	EXTINT[7:0]							
0x11		15:8	EXTINT[15:8]							
0x12		23:16	EXTINT[23:16]							
0x13		31:24	EXTINT[31:24]							
0x14	INTFLAG	7:0	EXTINT[7:0]							
0x15		15:8	EXTINT[15:8]							
0x16		23:16	EXTINT[23:16]							
0x17		31:24	EXTINT[31:24]							
0x18	ASYNCH	7:0	ASYNCH[7:0]							
0x19		15:8	ASYNCH[15:8]							
0x1A		23:16	ASYNCH[23:16]							
0x1B		31:24	ASYNCH[31:24]							
0x1C	CONFIG0	7:0	FILTENx	SENSEx[2:0]			FILTENx	SENSEx[2:0]		
0x1D		15:8	FILTENx	SENSEx[2:0]			FILTENx	SENSEx[2:0]		
0x1E		23:16	FILTENx	SENSEx[2:0]			FILTENx	SENSEx[2:0]		
0x1F		31:24	FILTENx	SENSEx[2:0]			FILTENx	SENSEx[2:0]		
0x20	CONFIG1	7:0	FILTENx	SENSEx[2:0]			FILTENx	SENSEx[2:0]		
0x21		15:8	FILTENx	SENSEx[2:0]			FILTENx	SENSEx[2:0]		
0x22		23:16	FILTENx	SENSEx[2:0]			FILTENx	SENSEx[2:0]		
0x23		31:24	FILTENx	SENSEx[2:0]			FILTENx	SENSEx[2:0]		
0x24	CONFIG2	7:0	FILTENx	SENSEx[2:0]			FILTENx	SENSEx[2:0]		
0x25		15:8	FILTENx	SENSEx[2:0]			FILTENx	SENSEx[2:0]		
0x26		23:16	FILTENx	SENSEx[2:0]			FILTENx	SENSEx[2:0]		
0x27		31:24	FILTENx	SENSEx[2:0]			FILTENx	SENSEx[2:0]		
0x28	CONFIG3	7:0	FILTENx	SENSEx[2:0]			FILTENx	SENSEx[2:0]		
0x29		15:8	FILTENx	SENSEx[2:0]			FILTENx	SENSEx[2:0]		
0x2A		23:16	FILTENx	SENSEx[2:0]			FILTENx	SENSEx[2:0]		
0x2B		31:24	FILTENx	SENSEx[2:0]			FILTENx	SENSEx[2:0]		

## 27.8 Register Description

Registers can be 8, 16, or 32 bits wide. Atomic 8-, 16-, and 32-bit accesses are supported. In addition, the 8-bit quarters and 16-bit halves of a 32-bit register, and the 8-bit halves of a 16-bit register can be accessed directly.

Some registers require synchronization when read and/or written. Synchronization is denoted by the "Read-Synchronized" and/or "Write-Synchronized" property in each individual register description.

Some registers are enable-protected, meaning they can only be written when the module is disabled. Enable-protection is denoted by the "Enable-Protected" property in each individual register description.

### 27.8.1 Control A

**Name:** CTRLA  
**Offset:** 0x00 [ID-00000c8b]  
**Reset:** 0x00  
**Property:** PAC Write-Protection

	7	6	5	4	3	2	1	0
				CKSEL			ENABLE	SWRST
Access				R/W			R/W	W
Reset				0			0	0

#### Bit 4 – CKSEL: Clock Selection

The EIC can be clocked either by GCLK\_EIC (when a frequency higher than 32KHz is required for filtering) or by CLK\_ULP32K (when power consumption is the priority).

This bit is not Write-Synchronized.

Value	Description
0	The EIC is clocked by GCLK_EIC.
1	The EIC is clocked by CLK_ULP32K.

#### Bit 1 – ENABLE: Enable

Due to synchronization there is a delay between writing to CTRLA.ENABLE until the peripheral is enabled/disabled. The value written to CTRLA.ENABLE will read back immediately and the Enable bit in the Synchronization Busy register will be set (SYNCBUSY.ENABLE=1). SYNCBUSY.ENABLE will be cleared when the operation is complete.

This bit is not Enable-Protected.

Value	Description
0	The EIC is disabled.
1	The EIC is enabled.

#### Bit 0 – SWRST: Software Reset

Writing a '0' to this bit has no effect.

Writing a '1' to this bit resets all registers in the EIC to their initial state, and the EIC will be disabled.

Writing a '1' to CTRLA.SWRST will always take precedence, meaning that all other writes in the same write operation will be discarded.

Due to synchronization there is a delay from writing CTRLA.SWRST until the Reset is complete. CTRLA.SWRST and SYNCBUSY.SWRST will both be cleared when the Reset is complete.

This bit is not Enable-Protected.

Value	Description
0	There is no ongoing reset operation.
1	The reset operation is ongoing.

## 27.8.2 Non-Maskable Interrupt Control

**Name:** NMICTRL  
**Offset:** 0x01 [ID-0000c8b]  
**Reset:** 0x00  
**Property:** PAC Write-Protection

Bit	7	6	5	4	3	2	1	0
				NMIASYNCH	NMIFILTEN	NMISENSE[2:0]		
Access				R/W	R/W	R/W	R/W	R/W
Reset				0	0	0	0	0

### Bit 4 – NMIASYNCH: Asynchronous Edge Detection Mode

The NMI edge detection can be operated synchronously or asynchronously to the EIC clock.

Value	Description
0	The NMI edge detection is synchronously operated.
1	The NMI edge detection is asynchronously operated.

### Bit 3 – NMIFILTEN: Non-Maskable Interrupt Filter Enable

Value	Description
0	NMI filter is disabled.
1	NMI filter is enabled.

### Bits 2:0 – NMISENSE[2:0]: Non-Maskable Interrupt Sense Configuration

These bits define on which edge or level the NMI triggers.

Value	Name	Description
0x0	NONE	No detection
0x1	RISE	Rising-edge detection
0x2	FALL	Falling-edge detection
0x3	BOTH	Both-edge detection
0x4	HIGH	High-level detection
0x5	LOW	Low-level detection
0x6 - 0x7	-	Reserved

## 27.8.3 Non-Maskable Interrupt Flag Status and Clear

**Name:** NMIFLAG  
**Offset:** 0x02 [ID-00000c8b]  
**Reset:** 0x0000  
**Property:** -



**Bit 0 – NMI: Non-Maskable Interrupt**

This flag is cleared by writing a '1' to it.

This flag is set when the NMI pin matches the NMI sense configuration, and will generate an interrupt request.

Writing a '0' to this bit has no effect.

Writing a '1' to this bit clears the non-maskable interrupt flag.

**27.8.4 Synchronization Busy**

**Name:** SYNCBUSY  
**Offset:** 0x04 [ID-00000c8b]  
**Reset:** 0x00000000  
**Property:** -

Bit	31	30	29	28	27	26	25	24
Access								
Reset								
Bit	23	22	21	20	19	18	17	16
Access								
Reset								
Bit	15	14	13	12	11	10	9	8
Access								
Reset								
Bit	7	6	5	4	3	2	1	0
							ENABLE	SWRST
Access							R	R
Reset							0	0

**Bit 1 – ENABLE: Enable Synchronization Busy Status**

Value	Description
0	Write synchronization for CTRLA.ENABLE bit is complete.
1	Write synchronization for CTRLA.ENABLE bit is ongoing.

**Bit 0 – SWRST: Software Reset Synchronization Busy Status**

Value	Description
0	Write synchronization for CTRLA.SWRST bit is complete.
1	Write synchronization for CTRLA.SWRST bit is ongoing.

### 27.8.5 Event Control

**Name:** EVCTRL  
**Offset:** 0x08 [ID-0000c8b]  
**Reset:** 0x00000000  
**Property:** PAC Write-Protection, Enable-Protected



Bit	31	30	29	28	27	26	25	24
	EXTINTEO[31:24]							
Access	R/W	R/W	R/W	R/W	R/W	R/W	R/W	R/W
Reset	0	0	0	0	0	0	0	0
Bit	23	22	21	20	19	18	17	16
	EXTINTEO[23:16]							
Access	R/W	R/W	R/W	R/W	R/W	R/W	R/W	R/W
Reset	0	0	0	0	0	0	0	0
Bit	15	14	13	12	11	10	9	8
	EXTINTEO[15:8]							
Access	R/W	R/W	R/W	R/W	R/W	R/W	R/W	R/W
Reset	0	0	0	0	0	0	0	0
Bit	7	6	5	4	3	2	1	0
	EXTINTEO[7:0]							
Access	R/W	R/W	R/W	R/W	R/W	R/W	R/W	R/W
Reset	0	0	0	0	0	0	0	0

### Bits 31:0 – EXTINTEO[31:0]: External Interrupt Event Output Enable

The bit x of EXTINTEO enables the event associated with the EXTINTx pin.

Value	Description
0	Event from pin EXTINTx is disabled.
1	Event from pin EXTINTx is enabled and will be generated when EXTINTx pin matches the external interrupt sensing configuration.

#### 27.8.6 Interrupt Enable Clear

This register allows the user to disable an interrupt without doing a read-modify-write operation. Changes in this register will also be reflected in the Interrupt Enable Set register (INTENSET).

**Name:** INTENCLR

**Offset:** 0x0C [ID-00000c8b]

**Reset:** 0x00000000

**Property:** PAC Write-Protection

Bit	31	30	29	28	27	26	25	24
	EXTINT[31:24]							
Access	R/W	R/W	R/W	R/W	R/W	R/W	R/W	R/W
Reset	0	0	0	0	0	0	0	0
Bit	23	22	21	20	19	18	17	16
	EXTINT[23:16]							
Access	R/W	R/W	R/W	R/W	R/W	R/W	R/W	R/W
Reset	0	0	0	0	0	0	0	0
Bit	15	14	13	12	11	10	9	8
	EXTINT[15:8]							
Access	R/W	R/W	R/W	R/W	R/W	R/W	R/W	R/W
Reset	0	0	0	0	0	0	0	0
Bit	7	6	5	4	3	2	1	0
	EXTINT[7:0]							
Access	R/W	R/W	R/W	R/W	R/W	R/W	R/W	R/W
Reset	0	0	0	0	0	0	0	0

### Bits 31:0 – EXTINT[31:0]: External Interrupt Enable

The bit x of EXTINT enables the interrupt associated with the EXTINTx pin.

Writing a '0' to bit x has no effect.

Writing a '1' to bit x will clear the External Interrupt Enable bit x, which disables the external interrupt EXTINTx.

Value	Description
0	The external interrupt x is disabled.
1	The external interrupt x is enabled.

### 27.8.7 Interrupt Enable Set

This register allows the user to enable an interrupt without doing a read-modify-write operation. Changes in this register will also be reflected in the Interrupt Enable Clear (INTENCLR) register.

**Name:** INTENSET

**Offset:** 0x10 [ID-0000c8b]

**Reset:** 0x00000000

**Property:** PAC Write-Protection

Bit	31	30	29	28	27	26	25	24
	EXTINT[31:24]							
Access	R/W	R/W	R/W	R/W	R/W	R/W	R/W	R/W
Reset	0	0	0	0	0	0	0	0
Bit	23	22	21	20	19	18	17	16
	EXTINT[23:16]							
Access	R/W	R/W	R/W	R/W	R/W	R/W	R/W	R/W
Reset	0	0	0	0	0	0	0	0
Bit	15	14	13	12	11	10	9	8
	EXTINT[15:8]							
Access	R/W	R/W	R/W	R/W	R/W	R/W	R/W	R/W
Reset	0	0	0	0	0	0	0	0
Bit	7	6	5	4	3	2	1	0
	EXTINT[7:0]							
Access	R/W	R/W	R/W	R/W	R/W	R/W	R/W	R/W
Reset	0	0	0	0	0	0	0	0

### Bits 31:0 – EXTINT[31:0]: External Interrupt Enable

The bit x of EXTINT enables the interrupt associated with the EXTINTx pin.

Writing a '0' to bit x has no effect.

Writing a '1' to bit x will set the External Interrupt Enable bit x, which enables the external interrupt EXTINTx.

Value	Description
0	The external interrupt x is disabled.
1	The external interrupt x is enabled.

### 27.8.8 Interrupt Flag Status and Clear

**Name:** INTFLAG

**Offset:** 0x14 [ID-00000c8b]

**Reset:** 0x00000000

**Property:** -

Bit	31	30	29	28	27	26	25	24
	EXTINT[31:24]							
Access	R/W	R/W	R/W	R/W	R/W	R/W	R/W	R/W
Reset	0	0	0	0	0	0	0	0
Bit	23	22	21	20	19	18	17	16
	EXTINT[23:16]							
Access	R/W	R/W	R/W	R/W	R/W	R/W	R/W	R/W
Reset	0	0	0	0	0	0	0	0
Bit	15	14	13	12	11	10	9	8
	EXTINT[15:8]							
Access	R/W	R/W	R/W	R/W	R/W	R/W	R/W	R/W
Reset	0	0	0	0	0	0	0	0
Bit	7	6	5	4	3	2	1	0
	EXTINT[7:0]							
Access	R/W	R/W	R/W	R/W	R/W	R/W	R/W	R/W
Reset	0	0	0	0	0	0	0	0

**Bits 31:0 – EXTINT[31:0]: External Interrupt**

The flag bit x is cleared by writing a '1' to it.

This flag is set when EXTINTx pin matches the external interrupt sense configuration and will generate an interrupt request if [INTENCLR/SET](#).EXTINT[x] is '1'.

Writing a '0' to this bit has no effect.

Writing a '1' to this bit clears the External Interrupt x flag.

**27.8.9 External Interrupt Asynchronous Mode**

**Name:** ASYNCH

**Offset:** 0x18 [ID-00000c8b]

**Reset:** 0x00000000

**Property:** PAC Write-Protection, Enable-Protected

Bit	31	30	29	28	27	26	25	24
	ASYNCH[31:24]							
Access	R/W	R/W	R/W	R/W	R/W	R/W	R/W	R/W
Reset	0	0	0	0	0	0	0	0
Bit	23	22	21	20	19	18	17	16
	ASYNCH[23:16]							
Access	R/W	R/W	R/W	R/W	R/W	R/W	R/W	R/W
Reset	0	0	0	0	0	0	0	0
Bit	15	14	13	12	11	10	9	8
	ASYNCH[15:8]							
Access	R/W	R/W	R/W	R/W	R/W	R/W	R/W	R/W
Reset	0	0	0	0	0	0	0	0
Bit	7	6	5	4	3	2	1	0
	ASYNCH[7:0]							
Access	R/W	R/W	R/W	R/W	R/W	R/W	R/W	R/W
Reset	0	0	0	0	0	0	0	0

### Bits 31:0 – ASYNCH[31:0]: Asynchronous Edge Detection Mode

The bit x of ASYNCH set the Asynchronous Edge Detection Mode for the interrupt associated with the EXTINTx pin.

Value	Description
0	The EXTINT x edge detection is synchronously operated.
1	The EXTINT x edge detection is asynchronously operated.

### 27.8.10 External Interrupt Sense Configuration n

**Name:** CONFIG0, CONFIG1, CONFIG2, CONFIG3

**Offset:** 0x1C + n\*0x04 [n=0..3]

**Reset:** 0x00000000

**Property:** PAC Write-Protection, Enable-Protected

Bit	31	30	29	28	27	26	25	24
	FILTENx	SENSEx[2:0]			FILTENx	SENSEx[2:0]		
Access	R/W	R/W	R/W	R/W	R/W	R/W	R/W	R/W
Reset	0	0	0	0	0	0	0	0
Bit	23	22	21	20	19	18	17	16
	FILTENx	SENSEx[2:0]			FILTENx	SENSEx[2:0]		
Access	R/W	R/W	R/W	R/W	R/W	R/W	R/W	R/W
Reset	0	0	0	0	0	0	0	0
Bit	15	14	13	12	11	10	9	8
	FILTENx	SENSEx[2:0]			FILTENx	SENSEx[2:0]		
Access	R/W	R/W	R/W	R/W	R/W	R/W	R/W	R/W
Reset	0	0	0	0	0	0	0	0
Bit	7	6	5	4	3	2	1	0
	FILTENx	SENSEx[2:0]			FILTENx	SENSEx[2:0]		
Access	R/W	R/W	R/W	R/W	R/W	R/W	R/W	R/W
Reset	0	0	0	0	0	0	0	0

**Bits 3,7,11,15,19,23,27,31 – FILTENx: Filter Enable x [x=7..0]**

Value	Description
0	Filter is disabled for EXTINT[n*8+x] input.
1	Filter is enabled for EXTINT[n*8+x] input.

**Bits 0:2,4:6,8:10,12:14,16:18,20:22,24:26,28:30 – SENSEx: Input Sense Configuration x [x=7..0]**

These bits define on which edge or level the interrupt or event for EXTINT[n\*8+x] will be generated.

Value	Name	Description
0x0	NONE	No detection
0x1	RISE	Rising-edge detection
0x2	FALL	Falling-edge detection
0x3	BOTH	Both-edge detection
0x4	HIGH	High-level detection
0x5	LOW	Low-level detection
0x6 - 0x7	-	Reserved

## 28. NVMCTRL – Non-Volatile Memory Controller

### 28.1 Overview

Non-Volatile Memory (NVM) is a reprogrammable Flash memory that retains program and data storage even with power off. It embeds a main array and a separate smaller array intended for EEPROM emulation (RWWEE) that can be programmed while reading the main array. The NVM Controller (NVMCTRL) connects to the AHB and APB bus interfaces for system access to the NVM block. The AHB interface is used for reads and writes to the NVM block, while the APB interface is used for commands and configuration.

### 28.2 Features

- 32-bit AHB interface for reads and writes
- Read While Write EEPROM emulation area
- All NVM sections are memory mapped to the AHB, including calibration and system configuration
- 32-bit APB interface for commands and control
- Programmable wait states for read optimization
- 16 regions can be individually protected or unprotected
- Additional protection for boot loader
- Supports device protection through a security bit
- Interface to Power Manager for power-down of Flash blocks in sleep modes
- Can optionally wake up on exit from sleep or on first access
- Direct-mapped cache

**Note:** A register with property "Enable-Protected" may contain bits that are *not* enable-protected.

### 28.3 Block Diagram

Figure 28-1. Block Diagram



## 28.4 Signal Description

Not applicable.

## 28.5 Product Dependencies

In order to use this peripheral, other parts of the system must be configured correctly, as described in the following sections.

### 28.5.1 Power Management

The NVMCTRL will continue to operate in any sleep mode where the selected source clock is running. The NVMCTRL interrupts can be used to wake up the device from sleep modes.

The Power Manager will automatically put the NVM block into a low-power state when entering sleep mode. This is based on the Control B register (CTRLB) SLEEPPRM bit setting. Refer to the [CTRLB.SLEEPPRM](#) register description for more details.

#### Related Links

[PM – Power Manager](#)

### 28.5.2 Clocks

Two synchronous clocks are used by the NVMCTRL. One is provided by the AHB bus (CLK\_NVMCTRL\_AHB) and the other is provided by the APB bus (CLK\_NVMCTRL\_APB). For higher system frequencies, a programmable number of wait states can be used to optimize performance. When changing the AHB bus frequency, the user must ensure that the NVM Controller is configured with the proper number of wait states. Refer to the Electrical Characteristics for the exact number of wait states to be used for a particular frequency range.

#### Related Links

[Electrical Characteristics 85°C \(SAM C20J/G/E\)](#)

### 28.5.3 Interrupts

The NVM Controller interrupt request line is connected to the interrupt controller. Using the NVMCTRL interrupt requires the interrupt controller to be programmed first.

### 28.5.4 Debug Operation

When an external debugger forces the CPU into debug mode, the peripheral continues normal operation.

Access to the NVM block can be protected by the security bit. In this case, the NVM block will not be accessible. See the section on the NVMCTRL [Security Bit](#) for details.

### 28.5.5 Register Access Protection

All registers with write-access are optionally write-protected by the Peripheral Access Controller (PAC), except the following registers:

- Interrupt Flag Status and Clear register (INTFLAG)
- Status register (STATUS)

Optional write-protection by the Peripheral Access Controller (PAC) is denoted by the "PAC Write-Protection" property in each individual register description.

#### Related Links

[PAC - Peripheral Access Controller](#)



## 28.5.6 Analog Connections

Not applicable.

## 28.6 Functional Description

### 28.6.1 Principle of Operation

The NVM Controller is a slave on the AHB and APB buses. It responds to commands, read requests and write requests, based on user configuration.

#### 28.6.1.1 Initialization

After power up, the NVM Controller goes through a power-up sequence. During this time, access to the NVM Controller from the AHB bus is halted. Upon power-up completion, the NVM Controller is operational without any need for user configuration.

### 28.6.2 Memory Organization

Refer to the Physical Memory Map for memory sizes and addresses for each device.

The NVM is organized into rows, where each row contains four pages, as shown in the NVM Row Organization figure. The NVM has a row-erase granularity, while the write granularity is by page. In other words, a single row erase will erase all four pages in the row, while four write operations are used to write the complete row.

**Figure 28-2. NVM Row Organization**

Row n	Page (n*4) + 3	Page (n*4) + 2	Page (n*4) + 1	Page (n*4) + 0
-------	----------------	----------------	----------------	----------------

The NVM block contains a calibration and auxiliary space plus a dedicated EEPROM emulation space that are memory mapped. Refer to the NVM Organization figure below for details.

The calibration and auxiliary space contains factory calibration and system configuration information. These spaces can be read from the AHB bus in the same way as the main NVM main address space.

In addition, a boot loader section can be allocated at the beginning of the main array, and an EEPROM section can be allocated at the end of the NVM main address space.

**Figure 28-3. NVM Memory Organization**



The lower rows in the NVM main address space can be allocated as a boot loader section by using the BOOTPROT fuses, and the upper rows can be allocated to EEPROM, as shown in the figure below.

The boot loader section is protected by the lock bit(s) corresponding to this address space and by the BOOTPROT[2:0] fuse. The EEPROM rows can be written regardless of the region lock status.

The number of rows protected by BOOTPROT is given in [Boot Loader Size](#), the number of rows allocated to the EEPROM are given in [EEPROM Size](#).

Figure 28-4. EEPROM and Boot Loader Allocation



**Related Links**

[Physical Memory Map](#)

### 28.6.3 Region Lock Bits

The NVM block is grouped into 16 equally sized regions. The region size is dependent on the Flash memory size, and is given in the table below. Each region has a dedicated lock bit preventing writing and erasing pages in the region. After production, all regions will be unlocked.

**Table 28-1. Region Size**

Memory Size [KB]	Region Size [KB]
256	16
128	8
64	4
32	2

To lock or unlock a region, the Lock Region and Unlock Region commands are provided. Writing one of these commands will temporarily lock/unlock the region containing the address loaded in the ADDR register. ADDR can be written by software, or the automatically loaded value from a write operation can be used. The new setting will stay in effect until the next Reset, or until the setting is changed again using

the Lock and Unlock commands. The current status of the lock can be determined by reading the LOCK register.

To change the default lock/unlock setting for a region, the user configuration section of the auxiliary space must be written using the Write Auxiliary Page command. Writing to the auxiliary space will take effect after the next Reset. Therefore, a boot of the device is needed for changes in the lock/unlock setting to take effect. Refer to the Physical Memory Map for calibration and auxiliary space address mapping.

### Related Links

[Physical Memory Map](#)

## 28.6.4 Command and Data Interface

The NVM Controller is addressable from the APB bus, while the NVM main address space is addressable from the AHB bus. Read and automatic page write operations are performed by addressing the NVM main address space or the RWWEE address space directly, while other operations such as manual page writes and row erases must be performed by issuing commands through the NVM Controller.

To issue a command, the CTRLA.CMD bits must be written along with the CTRLA.CMDDEX value. When a command is issued, INTFLAG.READY will be cleared until the command has completed. Any commands written while INTFLAG.READY is low will be ignored.

Read the [CTRLA](#) register description for more details.

The [CTRLB](#) register must be used to control the power reduction mode, read wait states, and the write mode.

### 28.6.4.1 NVM Read

Reading from the NVM main address space is performed via the AHB bus by addressing the NVM main address space or auxiliary address space directly. Read data is available after the configured number of read wait states (CTRLB.RWS) set in the NVM Controller.

The number of cycles data are delayed to the AHB bus is determined by the read wait states. Examples of using zero and one wait states are shown in Figure Read Wait State Examples below.

Reading the NVM main address space while a programming or erase operation is ongoing on the NVM main array results in an AHB bus stall until the end of the operation. Reading the NVM main array does not stall the bus when the RWWEE array is being programmed or erased.

**Figure 28-5. Read Wait State Examples**



## 28.6.4.2 RWWEE Read

Reading from the RWW EEPROM address space is performed via the AHB bus by addressing the RWWEE address space directly. Refer to the figures in [Memory Organization](#) for details.

Read timings are similar to regular NVM read timings when access size is Byte or half-Word. The AHB data phase is twice as long in case of full-Word-size access.

It is not possible to read the RWWEE area while the NVM main array is being written or erased, whereas the RWWEE area can be written or erased while the main array is being read.

The RWWEE address space is not cached, therefore it is recommended to limit access to this area for performance and power consumption considerations.

## 28.6.4.3 NVM Write

The NVM Controller requires that an erase must be done before programming. The entire NVM main address space and the RWWEE address space can be erased by a debugger Chip Erase command. Alternatively, rows can be individually erased by the Erase Row command or the RWWEE Erase Row command to erase the NVM main address space or the RWWEE address space, respectively.

After programming the NVM main array, the region that the page resides in can be locked to prevent spurious write or erase sequences. Locking is performed on a per-region basis, and so, locking a region will lock all pages inside the region.

Data to be written to the NVM block are first written to and stored in an internal buffer called the *page buffer*. The page buffer contains the same number of bytes as an NVM page. Writes to the page buffer must be 16 or 32 bits. 8-bit writes to the page buffer are not allowed and will cause a system exception.

Internally, writes to the page buffer are on a 64-bit basis through the page buffer load data register (PBLDATA1 and PBLDATA0). The PBLDATA register is a holding register for writes to the same 64-bit page buffer section. Data within a 64-bit section can be written in any order. Crossing a 64-bit boundary will reset the PBLDATA register to all ones. The following example assumes startup from reset where the current address is 0 and PBLDATA is all ones. Only 64 bits of the page buffer are written at a time, but 128 bits are shown for reference.

### Sequential 32-bit Write Example:

- 32-bit 0x1 written to address 0
  - Page buffer[127:0] = {0xFFFFFFFF\_FFFFFFFF, PBLDATA[63:32], 0x00000001}
  - PBLDATA[63:0] = {PBLDATA[63:32], 0x00000001}
- 32-bit 0x2 written to address 1
  - Page buffer[127:0] = {0xFFFFFFFF\_FFFFFFFF, 0x00000002, PBLDATA[31:0]}
  - PBLDATA[63:0] = 0x00000002, PBLDATA[31:0]}
- 32-bit 0x3 written to address 2 (crosses 64-bit boundary)
  - Page buffer[127:0] = 0xFFFFFFFF\_00000003\_00000002\_00000001
  - PBLDATA[63:0] = 0xFFFFFFFF\_00000003

Random access writes to 32-bit words within the page buffer will overwrite the opposite word within the same 64-bit section with ones. In the following example, notice that 0x00000001 is overwritten with 0xFFFFFFFF from the third write due to the 64-bit boundary crossing. Only 64 bits of the page buffer are written at a time, but 128 bits are shown for reference.

### Random Access 32-bit Write Example:

- 32-bit 0x1 written to address 2
  - Page buffer[127:0] = 0xFFFFFFFF\_00000001\_FFFFFFFF\_FFFFFFFF
  - PBLDATA[63:0] = 0xFFFFFFFF\_00000001

- 32-bit 0x2 written to address 1
  - Page buffer[127:0] = 0xFFFFFFFF\_00000001\_00000002\_FFFFFFFF
  - PBLDATA[63:0] = 0x00000002\_FFFFFFFF
- 32-bit 0x3 written to address 3
  - Page buffer[127:0] = 0x00000003\_FFFFFFFF\_00000002\_FFFFFFFF
  - PBLDATA[63:0] = 0x00000003\_0xFFFFFFFF

Both the NVM main array and the RWWEE array share the same page buffer. Writing to the NVM block via the AHB bus is performed by a load operation to the page buffer. For each AHB bus write, the address is stored in the ADDR register. After the page buffer has been loaded with the required number of bytes, the page can be written to the NVM main array or the RWWEE array by setting CTRLA.CMD to 'Write Page' or 'RWWEE Write Page', respectively, and setting the key value to CMDEX. The LOAD bit in the STATUS register indicates whether the page buffer has been loaded or not. Before writing the page to memory, the accessed row must be erased.

Automatic page writes are enabled by writing the manual write bit to zero (CTRLB.MANW=0). This will trigger a write operation to the page addressed by ADDR when the last location of the page is written.

Because the address is automatically stored in ADDR during the I/O bus write operation, the last given address will be present in the ADDR register. There is no need to load the ADDR register manually, unless a different page in memory is to be written.

#### Procedure for Manual Page Writes (CTRLB.MANW=1)

The row to be written to must be erased before the write command is given.

- Write to the page buffer by addressing the NVM main address space directly
- Write the page buffer to memory: CTRL.CMD='Write Page' and CMDEX
- The READY bit in the INTFLAG register will be low while programming is in progress, and access through the AHB will be stalled

#### Procedure for Automatic Page Writes (CTRLB.MANW=0)

The row to be written to must be erased before the last write to the page buffer is performed.

Note that partially written pages must be written with a manual write.

- Write to the page buffer by addressing the NVM main address space directly.  
When the last location in the page buffer is written, the page is automatically written to NVM main address space.
- INTFLAG.READY will be zero while programming is in progress and access through the AHB will be stalled.

#### 28.6.4.4 Page Buffer Clear

The page buffer is automatically set to all '1' after a page write is performed. If a partial page has been written and it is desired to clear the contents of the page buffer, the Page Buffer Clear command can be used.

#### 28.6.4.5 Erase Row

Before a page can be written, the row containing that page must be erased. The Erase Row command can be used to erase the desired row in the NVM main address space. The RWWEE Erase Row can be used to erase the desired row in the RWWEE array. Erasing the row sets all bits to '1'. If the row resides in a region that is locked, the erase will not be performed and the Lock Error bit in the Status register (STATUS.LOCKE) will be set.

#### Procedure for Erase Row

- Write the address of the row to erase to ADDR. Any address within the row can be used.

- Issue an Erase Row command.

**Note:** The NVM Address bit field in the Address register (ADDR.ADDR) uses 16-bit addressing.

### 28.6.4.6 Lock and Unlock Region

These commands are used to lock and unlock regions as detailed in section [Region Lock Bits](#).

### 28.6.4.7 Set and Clear Power Reduction Mode

The NVM Controller and block can be taken in and out of power reduction mode through the Set and Clear Power Reduction Mode commands. When the NVM Controller and block are in power reduction mode, the Power Reduction Mode bit in the Status register (STATUS.PRM) is set.

### 28.6.5 NVM User Configuration

The NVM user configuration resides in the auxiliary space. Refer to the Physical Memory Map of the device for calibration and auxiliary space address mapping.

The bootloader resides in the main array starting at offset zero. The allocated boot loader section is write-protected.

**Table 28-2. Boot Loader Size**

BOOTPROT [2:0]	Rows Protected by BOOTPROT	Boot Loader Size in Bytes
0x7 <sup>(1)</sup>	None	0
0x6	2	512
0x5	4	1024
0x4	8	2048
0x3	16	4096
0x2	32	8192
0x1	64	16384
0x0	128	32768

**Note:** 1) Default value is 0x7.

The EEPROM[2:0] bits indicate the EEPROM size, see the table below. The EEPROM resides in the upper rows of the NVM main address space and is writable, regardless of the region lock status.

**Table 28-3. EEPROM Size**

EEPROM[2:0]	Rows Allocated to EEPROM	EEPROM Size in Bytes
7	None	0
6	1	256
5	2	512
4	4	1024
3	8	2048
2	16	4096
1	32	8192
0	64	16384

## Related Links

[Physical Memory Map](#)

### 28.6.6 Security Bit

The security bit allows the entire chip to be locked from external access for code security. The security bit can be written by a dedicated command, Set Security Bit (SSB). Once set, the only way to clear the security bit is through a debugger Chip Erase command. After issuing the SSB command, the PROGE error bit can be checked.

In order to increase the security level it is recommended to enable the internal BODVDD when the security bit is set.

## Related Links

[DSU - Device Service Unit](#)

### 28.6.7 Cache

The NVM Controller cache reduces the device power consumption and improves system performance when wait states are required. Only the NVM main array address space is cached. It is a direct-mapped cache that implements 8 lines of 64 bits (i.e., 64 Bytes). NVM Controller cache can be enabled by writing a '0' to the Cache Disable bit in the Control B register ([CTRLB.CACHEDIS](#)).

The cache can be configured to three different modes using the Read Mode bit group in the Control B register ([CTRLB.READMODE](#)).

The INVALL command can be issued using the Command bits in the Control A register to invalidate all cache lines ([CTRLA.CMD=INVALL](#)). Commands affecting NVM content automatically invalidate cache lines.



## 28.7 Register Summary

Offset	Name	Bit Pos.									
0x00	CTRLA	7:0		CMD[6:0]							
0x01		15:8		CMDEX[7:0]							
0x02 ... 0x03	Reserved										
0x04	CTRLB	7:0	MANW		RWS[3:0]						
0x05		15:8						SLEPPRM[1:0]			
0x06		23:16			CACHEDIS[1:0]			READMODE[1:0]			
0x07		31:24									
0x08	PARAM	7:0		NVMP[7:0]							
0x09		15:8		NVMP[15:8]							
0x0A		23:16		RWWEEP[3:0]					PSZ[2:0]		
0x0B		31:24		RWWEEP[11:4]							
0x0C	INTENCLR	7:0						ERROR	READY		
0x0D ... 0x0F	Reserved										
0x10	INTENSET	7:0						ERROR	READY		
0x11 ... 0x13	Reserved										
0x14	INTFLAG	7:0						ERROR	READY		
0x15 ... 0x17	Reserved										
0x18	STATUS	7:0			NVME	LOCKE	PROGE	LOAD	PRM		
0x19		15:8							SB		
0x1A ... 0x1B	Reserved										
0x1C	ADDR	7:0		ADDR[7:0]							
0x1D		15:8		ADDR[15:8]							
0x1E		23:16			ADDR[20:16]						
0x1F		31:24									
0x20	LOCK	7:0		LOCK[7:0]							
0x21		15:8		LOCK[15:8]							
0x22 ... 0x27	Reserved										
0x28	PBLDATA0	7:0		PBLDATA[7:0]							
0x29		15:8		PBLDATA[15:8]							
0x2A		23:16		PBLDATA[23:16]							
0x2B		31:24		PBLDATA[31:24]							
0x2C	PBLDATA1	7:0		PBLDATA[7:0]							
0x2D		15:8		PBLDATA[15:8]							

Offset	Name	Bit Pos.							
0x2E		23:16							PBLDATA[23:16]
0x2F		31:24							PBLDATA[31:24]

## 28.8 Register Description

Registers can be 8, 16, or 32 bits wide. Atomic 8-, 16-, and 32-bit accesses are supported. In addition, the 8-bit quarters and 16-bit halves of a 32-bit register, and the 8-bit halves of a 16-bit register can be accessed directly.

Some registers require synchronization when read and/or written. Synchronization is denoted by the "Read-Synchronized" and/or "Write-Synchronized" property in each individual register description.

Some registers are enable-protected, meaning they can only be written when the module is disabled. Enable-protection is denoted by the "Enable-Protected" property in each individual register description.

### 28.8.1 Control A

**Name:** CTRLA  
**Offset:** 0x00 [ID-00000b2c]  
**Reset:** 0x0000  
**Property:** PAC Write-Protection

Bit	15	14	13	12	11	10	9	8
	CMDEX[7:0]							
Access	R/W	R/W	R/W	R/W	R/W	R/W	R/W	R/W
Reset	0	0	0	0	0	0	0	0
Bit	7	6	5	4	3	2	1	0
	CMD[6:0]							
Access		R/W	R/W	R/W	R/W	R/W	R/W	R/W
Reset		0	0	0	0	0	0	0

#### Bits 15:8 – CMDEX[7:0]: Command Execution

When this bit group is written to the key value 0xA5, the command written to CMD will be executed. If a value different from the key value is tried, the write will not be performed and the Programming Error bit in the Status register (STATUS.PROGE) will be set. PROGE is also set if a previously written command is not completed yet.

The key value must be written at the same time as CMD. If a command is issued through the APB bus on the same cycle as an AHB bus access, the AHB bus access will be given priority. The command will then be executed when the NVM block and the AHB bus are idle.

INTFLAG.READY must be '1' when the command is issued.

Bit 0 of the CMDEX bit group will read back as '1' until the command is issued.

**Note:** The NVM Address bit field in the Address register (ADDR.ADDR) uses 16-bit addressing.

#### Bits 6:0 – CMD[6:0]: Command

These bits define the command to be executed when the CMDEX key is written.

CMD[6:0]	Group Configuration	Description
0x00-0x01	-	Reserved
0x02	ER	Erase Row - Erases the row addressed by the ADDR register in the NVM main array.
0x03	-	Reserved
0x04	WP	Write Page - Writes the contents of the page buffer to the page addressed by the ADDR register.
0x05	EAR	Erase Auxiliary Row - Erases the auxiliary row addressed by the ADDR register. This command can be given only when the security bit is not set and only to the User Configuration Row.
0x06	WAP	Write Auxiliary Page - Writes the contents of the page buffer to the page addressed by the ADDR register. This command can be given only when the security bit is not set and only to the User Configuration Row.
0x07-0x0E	-	Reserved
0x0F	WL	Write Lockbits- write the LOCK register
0x1A-0x19	-	Reserved
0x1A	RWWEER	RWWE Erase Row - Erases the row addressed by the ADDR register in the RWWE array.
0x1B	-	Reserved
0x1C	RWWEWP	RWWE Write Page - Writes the contents of the page buffer to the page addressed by the ADDR register in the RWWE array.
0x1D-0x3F	-	Reserved
0x40	LR	Lock Region - Locks the region containing the address location in the ADDR register.
0x41	UR	Unlock Region - Unlocks the region containing the address location in the ADDR register.
0x42	SPRM	Sets the Power Reduction Mode.
0x43	CPRM	Clears the Power Reduction Mode.
0x44	PBC	Page Buffer Clear - Clears the page buffer.
0x45	SSB	Set Security Bit - Sets the security bit by writing 0x00 to the first byte in the lockbit row.
0x46	INVAL	Invalidates all cache lines.
0x47	LDR	Lock Data Region - Locks the data region containing the address location in the ADDR register. When the Security Extension is enabled, only secure access can lock secure regions.

CMD[6:0]	Group Configuration	Description
0x48	UDR	Unlock Data Region - Unlocks the data region containing the address location in the ADDR register. When the Security Extension is enabled, only secure access can unlock secure regions.
0x47-0x7F	-	Reserved

## 28.8.2 Control B

**Name:** CTRLB  
**Offset:** 0x04 [ID-00000b2c]  
**Reset:** 0x00000080  
**Property:** PAC Write-Protection

Bit	31	30	29	28	27	26	25	24
	[Bit Fields]							
Access								
Reset								
Bit	23	22	21	20	19	18	17	16
					CACHEDIS[1:0]		READMODE[1:0]	
Access					R/W	R/W	R/W	R/W
Reset					0	0	0	0
Bit	15	14	13	12	11	10	9	8
							SLEPPRM[1:0]	
Access							R/W	R/W
Reset							0	0
Bit	7	6	5	4	3	2	1	0
	MANW			RWS[3:0]				
Access	R/W			R/W	R/W	R/W	R/W	
Reset	1			0	0	0	0	

### Bits 19:18 – CACHEDIS[1:0]: Cache Disable

These bits are used to enable/disable caching of the NVM and RWW EEPROM sections. The same cache is used for both sections.

**Table 28-4. Cache Disabled**

CACHEDIS[1:0]	RWW EEPROM	NVM Cache
0x0	Disabled	Enabled
0x1	Disabled	Disabled
0x2	Enabled	Enabled
0x3	Reserved	Reserved

Value	Description
0	The cache is enabled
1	The cache is disabled

### Bits 17:16 – READMODE[1:0]: NVMCTRL Read Mode

Value	Name	Description
0x0	NO_MISS_PENALTY	The NVM Controller (cache system) does not insert wait states on a cache miss. Gives the best system performance.
0x1	LOW_POWER	Reduces power consumption of the cache system, but inserts a wait state each time there is a cache miss. This mode may not be relevant if CPU performance is required, as the application will be stalled and may lead to increased run time.
0x2	DETERMINISTIC	The cache system ensures that a cache hit or miss takes the same amount of time, determined by the number of programmed Flash wait states. This mode can be used for real-time applications that require deterministic execution timings.
0x3	Reserved	

### Bits 9:8 – SLEPPRM[1:0]: Power Reduction Mode during Sleep

Indicates the Power Reduction Mode during sleep.

Value	Name	Description
0x0	WAKEUPACCESS	NVM block enters low-power mode when entering sleep. NVM block exits low-power mode upon first access.
0x1	WAKEUPINSTANT	NVM block enters low-power mode when entering sleep. NVM block exits low-power mode when exiting sleep.
0x2	Reserved	
0x3	DISABLED	Auto power reduction disabled.

### Bit 7 – MANW: Manual Write

Note that reset value of this bit is '1'.

Value	Description
0	Writing to the last word in the page buffer will initiate a write operation to the page addressed by the last write operation. This includes writes to memory and auxiliary rows.
1	Write commands must be issued through the CTRLA.CMD register.

### Bits 4:1 – RWS[3:0]: NVM Read Wait States

These bits control the number of wait states for a read operation. '0' indicates zero wait states, '1' indicates one wait state, etc., up to 15 wait states.

This register is initialized to 0 wait states. Software can change this value based on the NVM access time and system frequency.

## 28.8.3 NVM Parameter

**Name:** PARAM  
**Offset:** 0x08 [ID-00000b2c]  
**Reset:** 0x000XXXXX  
**Property:** PAC Write-Protection

Bit	31	30	29	28	27	26	25	24
	RWWEEP[11:4]							
Access	R	R	R	R	R	R	R	R
Reset	0	0	0	0	0	0	0	0
Bit	23	22	21	20	19	18	17	16
	RWWEEP[3:0]				PSZ[2:0]			
Access	R	R	R	R		R	R	R
Reset	0	0	0	0		x	x	x
Bit	15	14	13	12	11	10	9	8
	NVMP[15:8]							
Access	R	R	R	R	R	R	R	R
Reset	x	x	x	x	x	x	x	x
Bit	7	6	5	4	3	2	1	0
	NVMP[7:0]							
Access	R	R	R	R	R	R	R	R
Reset	x	x	x	x	x	x	x	x

**Bits 31:20 – RWWEEP[11:0]: Read While Write EEPROM emulation area Pages**

Indicates the number of pages in the RWW EEPROM emulation address space.

**Bits 18:16 – PSZ[2:0]: Page Size**

Indicates the page size. Not all devices of the device families will provide all the page sizes indicated in the table.

Value	Name	Description
0x0	8	8 bytes
0x1	16	16 bytes
0x2	32	32 bytes
0x3	64	64 bytes
0x4	128	128 bytes
0x5	256	256 bytes
0x6	512	512 bytes
0x7	1024	1024 bytes

**Bits 15:0 – NVMP[15:0]: NVM Pages**

Indicates the number of pages in the NVM main address space.

### 28.8.4 Interrupt Enable Clear

This register allows the user to disable an interrupt without doing a read-modify-write operation. Changes in this register will also be reflected in the Interrupt Enable Set register (INTENSET).

**Name:** INTENCLR

**Offset:** 0x0C [ID-00000b2c]

**Reset:** 0x00

**Property:** PAC Write-Protection

Bit	7	6	5	4	3	2	1	0
							ERROR	READY
Access							R/W	R/W
Reset							0	0

**Bit 1 – ERROR: Error Interrupt Enable**

Writing a '0' to this bit has no effect.

Writing a '1' to this bit clears the ERROR interrupt enable.

This bit will read as the current value of the ERROR interrupt enable.

**Bit 0 – READY: NVM Ready Interrupt Enable**

Writing a '0' to this bit has no effect.

Writing a '1' to this bit clears the READY interrupt enable.

This bit will read as the current value of the READY interrupt enable.

### 28.8.5 Interrupt Enable Set

This register allows the user to enable an interrupt without doing a read-modify-write operation. Changes in this register will also be reflected in the Interrupt Enable Clear register (INTENCLR).

**Name:** INTENSET

**Offset:** 0x10 [ID-00000b2c]

**Reset:** 0x00

**Property:** PAC Write-Protection

Bit	7	6	5	4	3	2	1	0
							ERROR	READY
Access							R/W	R/W
Reset							0	0

**Bit 1 – ERROR: Error Interrupt Enable**

Writing a '0' to this bit has no effect.

Writing a '1' to this bit sets the ERROR interrupt enable.

This bit will read as the current value of the ERROR interrupt enable.

**Bit 0 – READY: NVM Ready Interrupt Enable**

Writing a '0' to this bit has no effect.

Writing a '1' to this bit sets the READY interrupt enable.

This bit will read as the current value of the READY interrupt enable.

### 28.8.6 Interrupt Flag Status and Clear

**Name:** INTFLAG

**Offset:** 0x14 [ID-00000b2c]

**Reset:** 0x00

**Property:** –

Bit	7	6	5	4	3	2	1	0
							ERROR	READY
Access							R/W	R
Reset							0	0

### Bit 1 – ERROR: Error

This flag is set on the occurrence of an NVME, LOCKE or PROGE error.

This bit can be cleared by writing a '1' to its bit location.

Value	Description
0	No errors have been received since the last clear.
1	At least one error has occurred since the last clear.

### Bit 0 – READY: NVM Ready

Value	Description
0	The NVM controller is busy programming or erasing.
1	The NVM controller is ready to accept a new command.

## 28.8.7 Status

**Name:** STATUS

**Offset:** 0x18 [ID-00000b2c]

**Reset:** 0x0X00

**Property:** –

Bit	15	14	13	12	11	10	9	8
								SB
Access								R
Reset								x
Bit	7	6	5	4	3	2	1	0
				NVME	LOCKE	PROGE	LOAD	PRM
Access				R/W	R/W	R/W	R/W	R
Reset				0	0	0	0	0

### Bit 8 – SB: Security Bit Status

Value	Description
0	The Security bit is inactive.
1	The Security bit is active.

### Bit 4 – NVME: NVM Error

This bit can be cleared by writing a '1' to its bit location.

Value	Description
0	No programming or erase errors have been received from the NVM controller since this bit was last cleared.
1	At least one error has been registered from the NVM Controller since this bit was last cleared.



### Bit 3 – LOCKE: Lock Error Status

This bit can be cleared by writing a '1' to its bit location.

Value	Description
0	No programming of any locked lock region has happened since this bit was last cleared.
1	Programming of at least one locked lock region has happened since this bit was last cleared.

### Bit 2 – PROGE: Programming Error Status

This bit can be cleared by writing a '1' to its bit location.

Value	Description
0	No invalid commands or bad keywords were written in the NVM Command register since this bit was last cleared.
1	An invalid command and/or a bad keyword was/were written in the NVM Command register since this bit was last cleared.

### Bit 1 – LOAD: NVM Page Buffer Active Loading

This bit indicates that the NVM page buffer has been loaded with one or more words. Immediately after an NVM load has been performed, this flag is set. It remains set until a page write or a page buffer clear (PBCLR) command is given.

This bit can be cleared by writing a '1' to its bit location.

### Bit 0 – PRM: Power Reduction Mode

This bit indicates the current NVM power reduction state. The NVM block can be set in power reduction mode in two ways: through the command interface or automatically when entering sleep with SLEEPPRM set accordingly.

PRM can be cleared in three ways: through AHB access to the NVM block, through the command interface (SPRM and CPRM) or when exiting sleep with SLEEPPRM set accordingly.

Value	Description
0	NVM is not in power reduction mode.
1	NVM is in power reduction mode.

## 28.8.8 Address

**Name:** ADDR

**Offset:** 0x1C [ID-00000b2c]

**Reset:** 0x00000000

**Property:** PAC Write-Protection

Bit	31	30	29	28	27	26	25	24
[Greyed out bits 31-24]								
Access								
Reset								
Bit	23	22	21	20	19	18	17	16
				ADDR[20:16]				
Access				R/W	R/W	R/W	R/W	R/W
Reset				0	0	0	0	0
Bit	15	14	13	12	11	10	9	8
ADDR[15:8]								
Access	R/W	R/W	R/W	R/W	R/W	R/W	R/W	R/W
Reset	0	0	0	0	0	0	0	0
Bit	7	6	5	4	3	2	1	0
ADDR[7:0]								
Access	R/W	R/W	R/W	R/W	R/W	R/W	R/W	R/W
Reset	0	0	0	0	0	0	0	0

**Bits 20:0 – ADDR[20:0]: NVM Address**

ADDR drives the hardware (16-bit) address to the NVM when a command is executed using CMDEX. This register is also automatically updated when writing to the page buffer.

**28.8.9 Lock Section**

**Name:** LOCK  
**Offset:** 0x20 [ID-00000b2c]  
**Reset:** 0XXXXX  
**Property:** –

Bit	15	14	13	12	11	10	9	8
LOCK[15:8]								
Access	R	R	R	R	R	R	R	R
Reset	0	0	0	0	0	0	0	0
Bit	7	6	5	4	3	2	1	0
LOCK[7:0]								
Access	R	R	R	R	R	R	R	R
Reset	0	0	0	0	0	0	0	x

**Bits 15:0 – LOCK[15:0]: Region Lock Bits**

In order to set or clear these bits, the CMD register must be used.

Default state after erase will be unlocked (0x0000).

Value	Description
0	The corresponding lock region is locked.
1	The corresponding lock region is not locked.

## 28.8.10 Page Buffer Load Data 0

**Name:** PBLDATA0  
**Offset:** 0x28  
**Reset:** 0xFFFFFFFF  
**Property:** -

	Bit	31	30	29	28	27	26	25	24
		PBLDATA[31:24]							
Access		R	R	R	R	R	R	R	R
Reset		1	1	1	1	1	1	1	1
	Bit	23	22	21	20	19	18	17	16
		PBLDATA[23:16]							
Access		R	R	R	R	R	R	R	R
Reset		1	1	1	1	1	1	1	1
	Bit	15	14	13	12	11	10	9	8
		PBLDATA[15:8]							
Access		R	R	R	R	R	R	R	R
Reset		1	1	1	1	1	1	1	1
	Bit	7	6	5	4	3	2	1	0
		PBLDATA[7:0]							
Access		R	R	R	R	R	R	R	R
Reset		1	1	1	1	1	1	1	1

### Bits 31:0 – PBLDATA[31:0]: Page Buffer Load Data

The PBLDATA register is a holding register for partial AHB writes to the same 64-bit page buffer section. Page buffer loads are performed on a 64-bit basis.

This is a read only register.

## 28.8.11 Page Buffer Load Data 1

**Name:** PBLDATA1  
**Offset:** 0x2C  
**Reset:** 0xFFFFFFFF  
**Property:** -

Bit	31	30	29	28	27	26	25	24
PBLDATA[31:24]								
Access	R	R	R	R	R	R	R	R
Reset	1	1	1	1	1	1	1	1
Bit	23	22	21	20	19	18	17	16
PBLDATA[23:16]								
Access	R	R	R	R	R	R	R	R
Reset	1	1	1	1	1	1	1	1
Bit	15	14	13	12	11	10	9	8
PBLDATA[15:8]								
Access	R	R	R	R	R	R	R	R
Reset	1	1	1	1	1	1	1	1
Bit	7	6	5	4	3	2	1	0
PBLDATA[7:0]								
Access	R	R	R	R	R	R	R	R
Reset	1	1	1	1	1	1	1	1

**Bits 31:0 – PBLDATA[31:0]: Page Buffer Load Data (Bits 63:32)** Once the dimension element functions are supported the bit description must be updated to bit names becomes **PBLDATA[63:32]** in the register table.

The PBLDATA register is a holding register for partial AHB writes to the same 64-bit page buffer section. Page buffer loads are performed on a 64-bit basis.

This is a read only register.

## 29. PORT - I/O Pin Controller

### 29.1 Overview

The IO Pin Controller (PORT) controls the I/O pins of the device. The I/O pins are organized in a series of groups, collectively referred to as a PORT group. Each PORT group can have up to 32 pins that can be configured and controlled individually or as a group. The number of PORT groups on a device may depend on the package/number of pins. Each pin may either be used for general-purpose I/O under direct application control or be assigned to an embedded device peripheral. When used for general-purpose I/O, each pin can be configured as input or output, with highly configurable driver and pull settings.

All I/O pins have true read-modify-write functionality when used for general-purpose I/O; the direction or the output value of one or more pins may be changed (set, reset or toggled) explicitly without unintentionally changing the state of any other pins in the same port group by a single, atomic 8-, 16- or 32-bit write.

The PORT is connected to the high-speed bus matrix through an AHB/APB bridge.

### 29.2 Features

- Selectable input and output configuration for each individual pin
- Software-controlled multiplexing of peripheral functions on I/O pins
- Flexible pin configuration through a dedicated Pin Configuration register
- Configurable output driver and pull settings:
  - Totem-pole (push-pull)
  - Pull configuration
  - Driver strength
- Configurable input buffer and pull settings:
  - Internal pull-up or pull-down
  - Input sampling criteria
  - Input buffer can be disabled if not needed for lower power consumption
- Input event:
  - Up to four input event pins for each PORT group
  - SET/CLEAR/TOGGLE event actions for each event input on output value of a pin
  - Can be output to pin
- Power saving using STANDBY mode
  - No access to configuration registers
  - Possible access to data registers (DIR, OUT or IN)

### 29.3 Block Diagram

Figure 29-1. PORT Block Diagram



### 29.4 Signal Description

Table 29-1. Signal description for PORT

Signal name	Type	Description
Pxy	Digital I/O	General-purpose I/O pin y in group x

Refer to the *I/O Multiplexing and Considerations* for details on the pin mapping for this peripheral. One signal can be mapped on several pins.

#### Related Links

[I/O Multiplexing and Considerations](#)

### 29.5 Product Dependencies

In order to use this peripheral, other parts of the system must be configured correctly as following.

#### 29.5.1 I/O Lines

The I/O lines of the PORT are mapped to pins of the physical device. The following naming scheme is used:

Each line bundle with up to 32 lines is assigned an identifier 'xy', with letter x=A, B, C... and two-digit number y=00, 01, ...31. Examples: A24, C03.

PORT pins are labeled 'Pxy' accordingly, for example PA24, PC03. This identifies each pin in the device uniquely.

Each pin may be controlled by one or more peripheral multiplexer settings, which allow the pad to be routed internally to a dedicated peripheral function. When the setting is enabled, the selected peripheral

has control over the output state of the pad, as well as the ability to read the current physical pad state. Refer to *I/O Multiplexing and Considerations* for details.

Device-specific configurations may cause some lines (and the corresponding Pxy pin) not to be implemented.

#### Related Links

[I/O Multiplexing and Considerations](#)

### 29.5.2 Power Management

During Reset, all PORT lines are configured as inputs with input buffers, output buffers and pull disabled.

The PORT peripheral will continue operating in any sleep mode where its source clock is running.

### 29.5.3 Clocks

The PORT bus clock (CLK\_PORT\_APB) can be enabled and disabled in the Main Clock module, and the default state of CLK\_PORT\_APB can be found in the *Peripheral Clock Masking* section in *MCLK – Main Clock*.

The EVSYS and APB will insert wait states in the event of concurrent PORT accesses.

The PORT input synchronizers use the CPU main clock so that the resynchronization delay is minimized with respect to the APB clock.

#### Related Links

[MCLK – Main Clock](#)

### 29.5.4 DMA

Not applicable.

### 29.5.5 Interrupts

Not applicable.

### 29.5.6 Events

The events of this peripheral are connected to the Event System.

#### Related Links

[EVSYS – Event System](#)

### 29.5.7 Debug Operation

When the CPU is halted in debug mode, this peripheral will continue normal operation. If the peripheral is configured to require periodical service by the CPU through interrupts or similar, improper operation or data loss may result during debugging. This peripheral can be forced to halt operation during debugging - refer to the Debug Control (DBGCTRL) register for details.

### 29.5.8 Register Access Protection

All registers with write-access can be optionally write-protected by the Peripheral Access Controller (PAC).

**Note:** Optional write-protection is indicated by the "PAC Write-Protection" property in the register description.

When the CPU is halted in debug mode, all write-protection is automatically disabled. Write-protection does not apply for accesses through an external debugger.

#### Related Links

## PAC - Peripheral Access Controller

### 29.5.9 Analog Connections

Analog functions are connected directly between the analog blocks and the I/O pads using analog buses. However, selecting an analog peripheral function for a given pin will disable the corresponding digital features of the pad.

## 29.6 Functional Description

Figure 29-2. Overview of the PORT

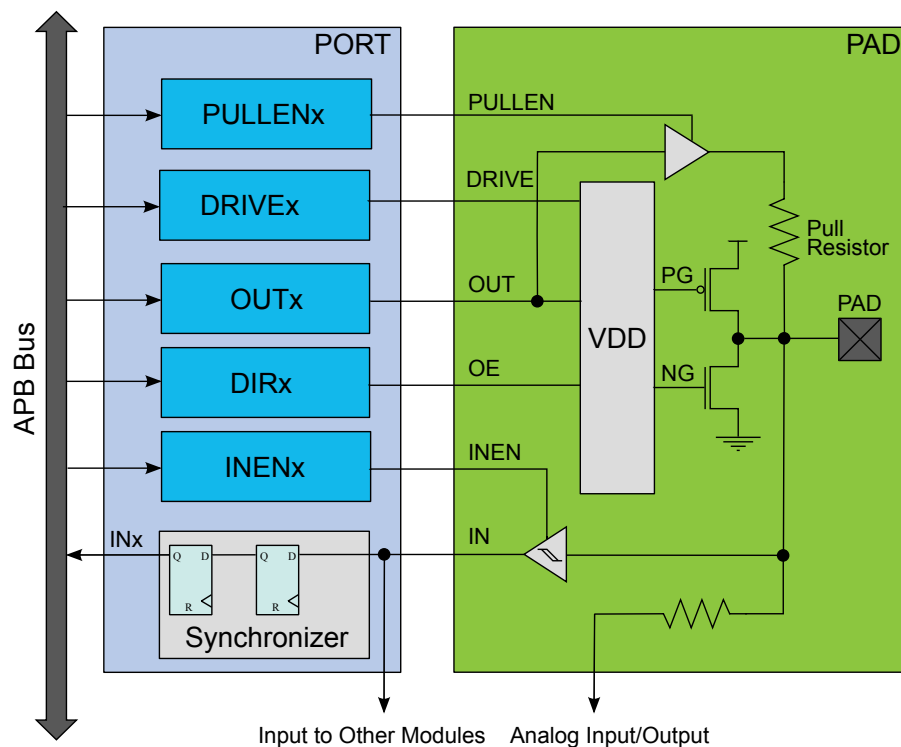

### 29.6.1 Principle of Operation

Each PORT group of up to 32 pins is controlled by the registers in PORT, as described in the figure. These registers in PORT are duplicated for each PORT group, with increasing base addresses. The number of PORT groups may depend on the package/number of pins.



Figure 29-3. Overview of the peripheral functions multiplexing



The I/O pins of the device are controlled by PORT peripheral registers. Each port pin has a corresponding bit in the Data Direction (DIR) and Data Output Value (OUT) registers to enable that pin as an output and to define the output state.

The direction of each pin in a PORT group is configured by the DIR register. If a bit in DIR is set to '1', the corresponding pin is configured as an output pin. If a bit in DIR is set to '0', the corresponding pin is configured as an input pin.

When the direction is set as output, the corresponding bit in the OUT register will set the level of the pin. If bit y in OUT is written to '1', pin y is driven HIGH. If bit y in OUT is written to '0', pin y is driven LOW. Pin configuration can be set by Pin Configuration (PINCFGy) registers, with y=00, 01, ..31 representing the bit position.

The Data Input Value (IN) is set as the input value of a port pin with resynchronization to the PORT clock. To reduce power consumption, these input synchronizers are clocked only when system requires reading the input value. The value of the pin can always be read, whether the pin is configured as input or output. If the Input Enable bit in the Pin Configuration registers (PINCFGy.INEN) is '0', the input value will not be sampled.

In PORT, the Peripheral Multiplexer Enable bit in the PINCFGy register (PINCFGy.PMUXEN) can be written to '1' to enable the connection between peripheral functions and individual I/O pins. The Peripheral Multiplexing n (PMUXn) registers select the peripheral function for the corresponding pin. This will override the connection between the PORT and that I/O pin, and connect the selected peripheral signal to the particular I/O pin instead of the PORT line bundle.

## 29.6.2 Basic Operation

### 29.6.2.1 Initialization

After reset, all standard function device I/O pads are connected to the PORT with outputs tri-stated and input buffers disabled, even if there is no clock running.

However, specific pins, such as those used for connection to a debugger, may be configured differently, as required by their special function.

## 29.6.2.2 Operation

Each I/O pin  $y$  can be controlled by the registers in PORT. Each PORT group has its own set of PORT registers, the base address of the register set for pin  $y$  is at byte address  $PORT + ([y] * 0x4)$ . The index within that register set is  $[y]$ .

To use pin number  $y$  as an *output*, write bit  $y$  of the DIR register to '1'. This can also be done by writing bit  $y$  in the DIRSET register to '1' - this will avoid disturbing the configuration of other pins in that group. The  $y$  bit in the OUT register must be written to the desired output value.

Similarly, writing an OUTSET bit to '1' will set the corresponding bit in the OUT register to '1'. Writing a bit in OUTCLR to '1' will set that bit in OUT to zero. Writing a bit in OUTTGL to '1' will toggle that bit in OUT.

To use pin  $y$  as an *input*, bit  $y$  in the DIR register must be written to '0'. This can also be done by writing bit  $y$  in the DIRCLR register to '1' - this will avoid disturbing the configuration of other pins in that group. The input value can be read from bit  $y$  in register IN as soon as the INEN bit in the Pin Configuration register (PINCFGy.INEN) is written to '1'.

Refer to *I/O Multiplexing and Considerations* for details on pin configuration and PORT groups.

By default, the input synchronizer is clocked only when an input read is requested. This will delay the read operation by two CLK\_PORT cycles. To remove the delay, the input synchronizers for each PORT group of eight pins can be configured to be always active, but this will increase power consumption. This is enabled by writing '1' to the corresponding SAMPLINGn bit field of the CTRL register, see CTRL.SAMPLING for details.

To use pin  $y$  as one of the available peripheral functions, the corresponding PMUXEN bit of the PINCFGy register must be '1'. The PINCFGy register for pin  $y$  is at byte offset (PINCFG0 +  $[y]$ ).

The peripheral function can be selected by setting the PMUXO or PMUXE in the PMUXn register. The PMUXO/PMUXE is at byte offset PMUX0 + ( $y/2$ ). The chosen peripheral must also be configured and enabled.

### Related Links

[I/O Multiplexing and Considerations](#)

## 29.6.3 I/O Pin Configuration

The Pin Configuration register (PINCFGy) is used for additional I/O pin configuration. A pin can be set in a totem-pole or pull configuration.

As pull configuration is done through the Pin Configuration register, all intermediate PORT states during switching of pin direction and pin values are avoided.

The I/O pin configurations are described further in this chapter, and summarized in [Table 29-2](#).

### 29.6.3.1 Pin Configurations Summary

**Table 29-2. Pin Configurations Summary**

DIR	INEN	PULLEN	OUT	Configuration
0	0	0	X	Reset or analog I/O: all digital disabled
0	0	1	0	Pull-down; input disabled
0	0	1	1	Pull-up; input disabled
0	1	0	X	Input
0	1	1	0	Input with pull-down

DIR	INEN	PULLEN	OUT	Configuration
0	1	1	1	Input with pull-up
1	0	X	X	Output; input disabled
1	1	X	X	Output; input enabled

### 29.6.3.2 Input Configuration

**Figure 29-4. I/O configuration - Standard Input**



**Figure 29-5. I/O Configuration - Input with Pull**

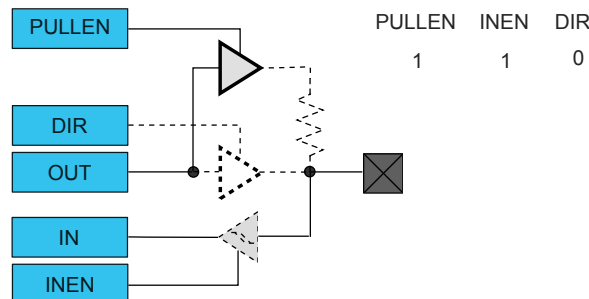

**Note:** When pull is enabled, the pull value is defined by the OUT value.

### 29.6.3.3 Totem-Pole Output

When configured for totem-pole (push-pull) output, the pin is driven low or high according to the corresponding bit setting in the OUT register. In this configuration there is no current limitation for sink or source other than what the pin is capable of. If the pin is configured for input, the pin will float if no external pull is connected.

**Note:** Enabling the output driver will automatically disable pull.

**Figure 29-6. I/O Configuration - Totem-Pole Output with Disabled Input**



**Figure 29-7. I/O Configuration - Totem-Pole Output with Enabled Input**



**Figure 29-8. I/O Configuration - Output with Pull**

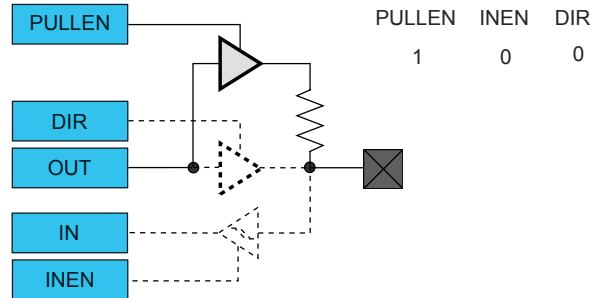

### 29.6.3.4 Digital Functionality Disabled

Neither Input nor Output functionality are enabled.

**Figure 29-9. I/O Configuration - Reset or Analog I/O: Digital Output, Input and Pull Disabled**



### 29.6.4 Events

The PORT allows input events to control individual I/O pins. These input events are generated by the EVSYS module and can originate from a different clock domain than the PORT module.

The PORT can perform the following actions:

- Output (OUT): I/O pin will be set when the incoming event has a high level ('1') and cleared when the incoming event has a low-level ('0').
- Set (SET): I/O pin will be set when an incoming event is detected.
- Clear (CLR): I/O pin will be cleared when an incoming event is detected.
- Toggle (TGL): I/O pin will toggle when an incoming event is detected.

The event is output to pin without any internal latency. For SET, CLEAR and TOGGLE event actions, the action will be executed up to three clock cycles after a rising edge.

The event actions can be configured with the Event Action m bit group in the Event Input Control register( EVCTRL.EVACTm). Writing a '1' to a PORT Event Enable Input m of the Event Control register (EVCTRL.PORTEIm) enables the corresponding action on input event. Writing '0' to this bit disables the

corresponding action on input event. Note that several actions can be enabled for incoming events. If several events are connected to the peripheral, any enabled action will be taken for any of the incoming events. Refer to *EVSYS – Event System*. for details on configuring the Event System.

Each event input can address one and only one I/O pin at a time. The selection of the pin is indicated by the PORT Event Pin Identifier of the Event Input Control register (EVCTR.PIDn). On the other hand, one I/O pin can be addressed by up to four different input events. To avoid action conflict on the output value of the register (OUT) of this particular I/O pin, only one action is performed according to the table below.

Note that this truth table can be applied to any SET/CLR/TGL configuration from two to four active input events.

**Table 29-3. Priority on Simultaneous SET/CLR/TGL Event Actions**

EVACT0	EVACT1	EVACT2	EVACT3	Executed Event Action
SET	SET	SET	SET	SET
CLR	CLR	CLR	CLR	CLR
All Other Combinations				TGL

Be careful when the event is output to pin. Due to the fact the events are received asynchronously, the I/O pin may have unpredictable levels, depending on the timing of when the events are received. When several events are output to the same pin, the lowest event line will get the access. All other events will be ignored.

**Related Links**

[EVSYS – Event System](#)

**29.6.5 PORT Access Priority**

The PORT is accessed by different systems:

- The ARM® CPU through the high-speed matrix and the AHB/APB bridge (APB)
- EVSYS through four asynchronous input events

The following priority is adopted:

1. APB
2. EVSYS input events

For input events that require different actions on the same I/O pin, refer to [Events](#).

## 29.7 Register Summary

Offset	Name	Bit Pos.								
0x00	DIR	7:0	DIR[7:0]							
0x01		15:8	DIR[15:8]							
0x02		23:16	DIR[23:16]							
0x03		31:24	DIR[31:24]							
0x04	DIRCLR	7:0	DIRCLR[7:0]							
0x05		15:8	DIRCLR[15:8]							
0x06		23:16	DIRCLR[23:16]							
0x07		31:24	DIRCLR[31:24]							
0x08	DIRSET	7:0	DIRSET[7:0]							
0x09		15:8	DIRSET[15:8]							
0x0A		23:16	DIRSET[23:16]							
0x0B		31:24	DIRSET[31:24]							
0x0C	DIRTGL	7:0	DIRTGL[7:0]							
0x0D		15:8	DIRTGL[15:8]							
0x0E		23:16	DIRTGL[23:16]							
0x0F		31:24	DIRTGL[31:24]							
0x10	OUT	7:0	OUT[7:0]							
0x11		15:8	OUT[15:8]							
0x12		23:16	OUT[23:16]							
0x13		31:24	OUT[31:24]							
0x14	OUTCLR	7:0	OUTCLR[7:0]							
0x15		15:8	OUTCLR[15:8]							
0x16		23:16	OUTCLR[23:16]							
0x17		31:24	OUTCLR[31:24]							
0x18	OUTSET	7:0	OUTSET[7:0]							
0x19		15:8	OUTSET[15:8]							
0x1A		23:16	OUTSET[23:16]							
0x1B		31:24	OUTSET[31:24]							
0x1C	OUTTGL	7:0	OUTTGL[7:0]							
0x1D		15:8	OUTTGL[15:8]							
0x1E		23:16	OUTTGL[23:16]							
0x1F		31:24	OUTTGL[31:24]							
0x20	IN	7:0	IN[7:0]							
0x21		15:8	IN[15:8]							
0x22		23:16	IN[23:16]							
0x23		31:24	IN[31:24]							
0x24	CTRL	7:0	SAMPLING[7:0]							
0x25		15:8	SAMPLING[15:8]							
0x26		23:16	SAMPLING[23:16]							
0x27		31:24	SAMPLING[31:24]							
0x28	WRCONFIG	7:0	PINMASK[7:0]							
0x29		15:8	PINMASK[15:8]							
0x2A		23:16		DRVSTR				PULLEN	INEN	PMUXEN
0x2B		31:24	HWSEL	WRPINCFG		WRPMUX		PMUX[3:0]		

Offset	Name	Bit Pos.								
0x2C	EVCTRL	7:0	PORTEIx	EVACTx[1:0]				PIDx[4:0]		
0x2D		15:8	PORTEIx	EVACTx[1:0]				PIDx[4:0]		
0x2E		23:16	PORTEIx	EVACTx[1:0]				PIDx[4:0]		
0x2F		31:24	PORTEIx	EVACTx[1:0]				PIDx[4:0]		
0x30	PMUX0	7:0		PMUXO[3:0]				PMUXE[3:0]		
0x31	PMUX1	7:0		PMUXO[3:0]				PMUXE[3:0]		
0x32	PMUX2	7:0		PMUXO[3:0]				PMUXE[3:0]		
0x33	PMUX3	7:0		PMUXO[3:0]				PMUXE[3:0]		
0x34	PMUX4	7:0		PMUXO[3:0]				PMUXE[3:0]		
0x35	PMUX5	7:0		PMUXO[3:0]				PMUXE[3:0]		
0x36	PMUX6	7:0		PMUXO[3:0]				PMUXE[3:0]		
0x37	PMUX7	7:0		PMUXO[3:0]				PMUXE[3:0]		
0x38	PMUX8	7:0		PMUXO[3:0]				PMUXE[3:0]		
0x39	PMUX9	7:0		PMUXO[3:0]				PMUXE[3:0]		
0x3A	PMUX10	7:0		PMUXO[3:0]				PMUXE[3:0]		
0x3B	PMUX11	7:0		PMUXO[3:0]				PMUXE[3:0]		
0x3C	PMUX12	7:0		PMUXO[3:0]				PMUXE[3:0]		
0x3D	PMUX13	7:0		PMUXO[3:0]				PMUXE[3:0]		
0x3E	PMUX14	7:0		PMUXO[3:0]				PMUXE[3:0]		
0x3F	PMUX15	7:0		PMUXO[3:0]				PMUXE[3:0]		
0x40	PINCFG0	7:0		DRVSTR				PULLEN	INEN	PMUXEN
0x41	PINCFG1	7:0		DRVSTR				PULLEN	INEN	PMUXEN
0x42	PINCFG2	7:0		DRVSTR				PULLEN	INEN	PMUXEN
0x43	PINCFG3	7:0		DRVSTR				PULLEN	INEN	PMUXEN
0x44	PINCFG4	7:0		DRVSTR				PULLEN	INEN	PMUXEN
0x45	PINCFG5	7:0		DRVSTR				PULLEN	INEN	PMUXEN
0x46	PINCFG6	7:0		DRVSTR				PULLEN	INEN	PMUXEN
0x47	PINCFG7	7:0		DRVSTR				PULLEN	INEN	PMUXEN
0x48	PINCFG8	7:0		DRVSTR				PULLEN	INEN	PMUXEN
0x49	PINCFG9	7:0		DRVSTR				PULLEN	INEN	PMUXEN
0x4A	PINCFG10	7:0		DRVSTR				PULLEN	INEN	PMUXEN
0x4B	PINCFG11	7:0		DRVSTR				PULLEN	INEN	PMUXEN
0x4C	PINCFG12	7:0		DRVSTR				PULLEN	INEN	PMUXEN
0x4D	PINCFG13	7:0		DRVSTR				PULLEN	INEN	PMUXEN
0x4E	PINCFG14	7:0		DRVSTR				PULLEN	INEN	PMUXEN
0x4F	PINCFG15	7:0		DRVSTR				PULLEN	INEN	PMUXEN
0x50	PINCFG16	7:0		DRVSTR				PULLEN	INEN	PMUXEN
0x51	PINCFG17	7:0		DRVSTR				PULLEN	INEN	PMUXEN
0x52	PINCFG18	7:0		DRVSTR				PULLEN	INEN	PMUXEN
0x53	PINCFG19	7:0		DRVSTR				PULLEN	INEN	PMUXEN
0x54	PINCFG20	7:0		DRVSTR				PULLEN	INEN	PMUXEN
0x55	PINCFG21	7:0		DRVSTR				PULLEN	INEN	PMUXEN
0x56	PINCFG22	7:0		DRVSTR				PULLEN	INEN	PMUXEN
0x57	PINCFG23	7:0		DRVSTR				PULLEN	INEN	PMUXEN
0x58	PINCFG24	7:0		DRVSTR				PULLEN	INEN	PMUXEN
0x59	PINCFG25	7:0		DRVSTR				PULLEN	INEN	PMUXEN
0x5A	PINCFG26	7:0		DRVSTR				PULLEN	INEN	PMUXEN

Offset	Name	Bit Pos.								
0x5B	<a href="#">PINCFG27</a>	7:0		DRVSTR				PULLEN	INEN	PMUXEN
0x5C	<a href="#">PINCFG28</a>	7:0		DRVSTR				PULLEN	INEN	PMUXEN
0x5D	<a href="#">PINCFG29</a>	7:0		DRVSTR				PULLEN	INEN	PMUXEN
0x5E	<a href="#">PINCFG30</a>	7:0		DRVSTR				PULLEN	INEN	PMUXEN
0x5F	<a href="#">PINCFG31</a>	7:0		DRVSTR				PULLEN	INEN	PMUXEN

## 29.8 PORT Pin Groups and Register Repetition



**Tip:** The I/O pins are assembled in pin groups ("PORT groups") with up to 32 pins. Group 0 consists of the PA pins, group 1 is for the PB pins, etc. Each pin group has its own PORT registers. For example, the register address offset for the Data Direction (DIR) register for group 0 (PA00 to PA31) is 0x00, and the register address offset for the DIR register for group 1 (PB00 to PB31) is 0x80.

## 29.9 Register Description

Registers can be 8, 16, or 32 bits wide. Atomic 8-, 16- and 32-bit accesses are supported. In addition, the 8-bit quarters and 16-bit halves of a 32-bit register, and the 8-bit halves of a 16-bit register can be accessed directly.

Some registers are optionally write-protected by the Peripheral Access Controller (PAC). Optional PAC write-protection is denoted by the "PAC Write-Protection" property in each individual register description. For details, refer to [Register Access Protection](#).

### 29.9.1 Data Direction

This register allows the user to configure one or more I/O pins as an input or output. This register can be manipulated without doing a read-modify-write operation by using the Data Direction Toggle (DIRTGL), Data Direction Clear (DIRCLR) and Data Direction Set (DIRSET) registers.



**Tip:** The I/O pins are assembled in pin groups ("PORT groups") with up to 32 pins. Group 0 consists of the PA pins, group 1 is for the PB pins, etc. Each pin group has its own PORT registers. For example, the register address offset for the Data Direction (DIR) register for group 0 (PA00 to PA31) is 0x00, and the register address offset for the DIR register for group 1 (PB00 to PB31) is 0x80.

**Name:** DIR  
**Offset:** 0x00 [ID-000011ca]  
**Reset:** 0x00000000  
**Property:** PAC Write-Protection



Bit	31	30	29	28	27	26	25	24
DIR[31:24]								
Access	R/W	R/W	R/W	R/W	R/W	R/W	R/W	R/W
Reset	0	0	0	0	0	0	0	0
Bit	23	22	21	20	19	18	17	16
DIR[23:16]								
Access	R/W	R/W	R/W	R/W	R/W	R/W	R/W	R/W
Reset	0	0	0	0	0	0	0	0
Bit	15	14	13	12	11	10	9	8
DIR[15:8]								
Access	R/W	R/W	R/W	R/W	R/W	R/W	R/W	R/W
Reset	0	0	0	0	0	0	0	0
Bit	7	6	5	4	3	2	1	0
DIR[7:0]								
Access	R/W	R/W	R/W	R/W	R/W	R/W	R/W	R/W
Reset	0	0	0	0	0	0	0	0

### Bits 31:0 – DIR[31:0]: Port Data Direction

These bits set the data direction for the individual I/O pins in the PORT group.

Value	Description
0	The corresponding I/O pin in the PORT group is configured as an input.
1	The corresponding I/O pin in the PORT group is configured as an output.

#### 29.9.2 Data Direction Clear

This register allows the user to set one or more I/O pins as an input, without doing a read-modify-write operation. Changes in this register will also be reflected in the Data Direction (DIR), Data Direction Toggle (DIRTGL) and Data Direction Set (DIRSET) registers.



**Tip:** The I/O pins are assembled in pin groups (“PORT groups”) with up to 32 pins. Group 0 consists of the PA pins, group 1 is for the PB pins, etc. Each pin group has its own PORT registers. For example, the register address offset for the Data Direction (DIR) register for group 0 (PA00 to PA31) is 0x00, and the register address offset for the DIR register for group 1 (PB00 to PB31) is 0x80.

**Name:** DIRCLR  
**Offset:** 0x04 [ID-000011ca]  
**Reset:** 0x00000000  
**Property:** PAC Write-Protection

Bit	31	30	29	28	27	26	25	24
DIRCLR[31:24]								
Access	R/W	R/W	R/W	R/W	R/W	R/W	R/W	R/W
Reset	0	0	0	0	0	0	0	0
Bit	23	22	21	20	19	18	17	16
DIRCLR[23:16]								
Access	R/W	R/W	R/W	R/W	R/W	R/W	R/W	R/W
Reset	0	0	0	0	0	0	0	0
Bit	15	14	13	12	11	10	9	8
DIRCLR[15:8]								
Access	R/W	R/W	R/W	R/W	R/W	R/W	R/W	R/W
Reset	0	0	0	0	0	0	0	0
Bit	7	6	5	4	3	2	1	0
DIRCLR[7:0]								
Access	R/W	R/W	R/W	R/W	R/W	R/W	R/W	R/W
Reset	0	0	0	0	0	0	0	0

### Bits 31:0 – DIRCLR[31:0]: Port Data Direction Clear

Writing a '0' to a bit has no effect.

Writing a '1' to a bit will clear the corresponding bit in the DIR register, which configures the I/O pin as an input.

Value	Description
0	The corresponding I/O pin in the PORT group will keep its configuration.
1	The corresponding I/O pin in the PORT group is configured as input.

### 29.9.3 Data Direction Set

This register allows the user to set one or more I/O pins as an output, without doing a read-modify-write operation. Changes in this register will also be reflected in the Data Direction (DIR), Data Direction Toggle (DIRTGL) and Data Direction Clear (DIRCLR) registers.



**Tip:** The I/O pins are assembled in pin groups ("PORT groups") with up to 32 pins. Group 0 consists of the PA pins, group 1 is for the PB pins, etc. Each pin group has its own PORT registers. For example, the register address offset for the Data Direction (DIR) register for group 0 (PA00 to PA31) is 0x00, and the register address offset for the DIR register for group 1 (PB00 to PB31) is 0x80.

**Name:** DIRSET

**Offset:** 0x08 [ID-000011ca]

**Reset:** 0x00000000

**Property:** PAC Write-Protection

Bit	31	30	29	28	27	26	25	24
DIRSET[31:24]								
Access	R/W	R/W	R/W	R/W	R/W	R/W	R/W	R/W
Reset	0	0	0	0	0	0	0	0
Bit	23	22	21	20	19	18	17	16
DIRSET[23:16]								
Access	R/W	R/W	R/W	R/W	R/W	R/W	R/W	R/W
Reset	0	0	0	0	0	0	0	0
Bit	15	14	13	12	11	10	9	8
DIRSET[15:8]								
Access	R/W	R/W	R/W	R/W	R/W	R/W	R/W	R/W
Reset	0	0	0	0	0	0	0	0
Bit	7	6	5	4	3	2	1	0
DIRSET[7:0]								
Access	R/W	R/W	R/W	R/W	R/W	R/W	R/W	R/W
Reset	0	0	0	0	0	0	0	0

### Bits 31:0 – DIRSET[31:0]: Port Data Direction Set

Writing '0' to a bit has no effect.

Writing '1' to a bit will set the corresponding bit in the DIR register, which configures the I/O pin as an output.

Value	Description
0	The corresponding I/O pin in the PORT group will keep its configuration.
1	The corresponding I/O pin in the PORT group is configured as an output.

#### 29.9.4 Data Direction Toggle

This register allows the user to toggle the direction of one or more I/O pins, without doing a read-modify-write operation. Changes in this register will also be reflected in the Data Direction (DIR), Data Direction Set (DIRSET) and Data Direction Clear (DIRCLR) registers.



**Tip:** The I/O pins are assembled in pin groups ("PORT groups") with up to 32 pins. Group 0 consists of the PA pins, group 1 is for the PB pins, etc. Each pin group has its own PORT registers. For example, the register address offset for the Data Direction (DIR) register for group 0 (PA00 to PA31) is 0x00, and the register address offset for the DIR register for group 1 (PB00 to PB31) is 0x80.

**Name:** DIRTGL

**Offset:** 0x0C [ID-000011ca]

**Reset:** 0x00000000

**Property:** PAC Write-Protection

Bit	31	30	29	28	27	26	25	24
	DIRTGL[31:24]							
Access	R/W	R/W	R/W	R/W	R/W	R/W	R/W	R/W
Reset	0	0	0	0	0	0	0	0
Bit	23	22	21	20	19	18	17	16
	DIRTGL[23:16]							
Access	R/W	R/W	R/W	R/W	R/W	R/W	R/W	R/W
Reset	0	0	0	0	0	0	0	0
Bit	15	14	13	12	11	10	9	8
	DIRTGL[15:8]							
Access	R/W	R/W	R/W	R/W	R/W	R/W	R/W	R/W
Reset	0	0	0	0	0	0	0	0
Bit	7	6	5	4	3	2	1	0
	DIRTGL[7:0]							
Access	R/W	R/W	R/W	R/W	R/W	R/W	R/W	R/W
Reset	0	0	0	0	0	0	0	0

### Bits 31:0 – DIRTGL[31:0]: Port Data Direction Toggle

Writing '0' to a bit has no effect.

Writing '1' to a bit will toggle the corresponding bit in the DIR register, which reverses the direction of the I/O pin.

Value	Description
0	The corresponding I/O pin in the PORT group will keep its configuration.
1	The direction of the corresponding I/O pin is toggled.

### 29.9.5 Data Output Value

This register sets the data output drive value for the individual I/O pins in the PORT.

This register can be manipulated without doing a read-modify-write operation by using the Data Output Value Clear (OUTCLR), Data Output Value Set (OUTSET), and Data Output Value Toggle (OUTTGL) registers.



**Tip:** The I/O pins are assembled in pin groups ("PORT groups") with up to 32 pins. Group 0 consists of the PA pins, group 1 is for the PB pins, etc. Each pin group has its own PORT registers. For example, the register address offset for the Data Direction (DIR) register for group 0 (PA00 to PA31) is 0x00, and the register address offset for the DIR register for group 1 (PB00 to PB31) is 0x80.

**Name:** OUT  
**Offset:** 0x10 [ID-000011ca]  
**Reset:** 0x00000000  
**Property:** PAC Write-Protection

Bit	31	30	29	28	27	26	25	24
	OUT[31:24]							
Access	R/W	R/W	R/W	R/W	R/W	R/W	R/W	R/W
Reset	0	0	0	0	0	0	0	0
Bit	23	22	21	20	19	18	17	16
	OUT[23:16]							
Access	R/W	R/W	R/W	R/W	R/W	R/W	R/W	R/W
Reset	0	0	0	0	0	0	0	0
Bit	15	14	13	12	11	10	9	8
	OUT[15:8]							
Access	R/W	R/W	R/W	R/W	R/W	R/W	R/W	R/W
Reset	0	0	0	0	0	0	0	0
Bit	7	6	5	4	3	2	1	0
	OUT[7:0]							
Access	R/W	R/W	R/W	R/W	R/W	R/W	R/W	R/W
Reset	0	0	0	0	0	0	0	0

### Bits 31:0 – OUT[31:0]: PORT Data Output Value

For pins configured as outputs via the Data Direction register (DIR), these bits set the logical output drive level.

For pins configured as inputs via the Data Direction register (DIR) and with pull enabled via the Pull Enable bit in the Pin Configuration register (PINCFG.PULLEN), these bits will set the input pull direction.

Value	Description
0	The I/O pin output is driven low, or the input is connected to an internal pull-down.
1	The I/O pin output is driven high, or the input is connected to an internal pull-up.

### 29.9.6 Data Output Value Clear

This register allows the user to set one or more output I/O pin drive levels low, without doing a read-modify-write operation. Changes in this register will also be reflected in the Data Output Value (OUT), Data Output Value Toggle (OUTTGL) and Data Output Value Set (OUTSET) registers.



**Tip:** The I/O pins are assembled in pin groups ("PORT groups") with up to 32 pins. Group 0 consists of the PA pins, group 1 is for the PB pins, etc. Each pin group has its own PORT registers. For example, the register address offset for the Data Direction (DIR) register for group 0 (PA00 to PA31) is 0x00, and the register address offset for the DIR register for group 1 (PB00 to PB31) is 0x80.

**Name:** OUTCLR  
**Offset:** 0x14 [ID-000011ca]  
**Reset:** 0x00000000  
**Property:** PAC Write-Protection

Bit	31	30	29	28	27	26	25	24
	OUTCLR[31:24]							
Access	R/W	R/W	R/W	R/W	R/W	R/W	R/W	R/W
Reset	0	0	0	0	0	0	0	0
Bit	23	22	21	20	19	18	17	16
	OUTCLR[23:16]							
Access	R/W	R/W	R/W	R/W	R/W	R/W	R/W	R/W
Reset	0	0	0	0	0	0	0	0
Bit	15	14	13	12	11	10	9	8
	OUTCLR[15:8]							
Access	R/W	R/W	R/W	R/W	R/W	R/W	R/W	R/W
Reset	0	0	0	0	0	0	0	0
Bit	7	6	5	4	3	2	1	0
	OUTCLR[7:0]							
Access	R/W	R/W	R/W	R/W	R/W	R/W	R/W	R/W
Reset	0	0	0	0	0	0	0	0

### Bits 31:0 – OUTCLR[31:0]: PORT Data Output Value Clear

Writing '0' to a bit has no effect.

Writing '1' to a bit will clear the corresponding bit in the OUT register. Pins configured as outputs via the Data Direction register (DIR) will be set to low output drive level. Pins configured as inputs via DIR and with pull enabled via the Pull Enable bit in the Pin Configuration register (PINCFG.PULLEN) will set the input pull direction to an internal pull-down.

Value	Description
0	The corresponding I/O pin in the PORT group will keep its configuration.
1	The corresponding I/O pin output is driven low, or the input is connected to an internal pull-down.

### 29.9.7 Data Output Value Set

This register allows the user to set one or more output I/O pin drive levels high, without doing a read-modify-write operation. Changes in this register will also be reflected in the Data Output Value (OUT), Data Output Value Toggle (OUTTGL) and Data Output Value Clear (OUTCLR) registers.



**Tip:** The I/O pins are assembled in pin groups ("PORT groups") with up to 32 pins. Group 0 consists of the PA pins, group 1 is for the PB pins, etc. Each pin group has its own PORT registers. For example, the register address offset for the Data Direction (DIR) register for group 0 (PA00 to PA31) is 0x00, and the register address offset for the DIR register for group 1 (PB00 to PB31) is 0x80.

**Name:** OUTSET  
**Offset:** 0x18 [ID-000011ca]  
**Reset:** 0x00000000  
**Property:** PAC Write-Protection

Bit	31	30	29	28	27	26	25	24
	OUTSET[31:24]							
Access	R/W	R/W	R/W	R/W	R/W	R/W	R/W	R/W
Reset	0	0	0	0	0	0	0	0
Bit	23	22	21	20	19	18	17	16
	OUTSET[23:16]							
Access	R/W	R/W	R/W	R/W	R/W	R/W	R/W	R/W
Reset	0	0	0	0	0	0	0	0
Bit	15	14	13	12	11	10	9	8
	OUTSET[15:8]							
Access	R/W	R/W	R/W	R/W	R/W	R/W	R/W	R/W
Reset	0	0	0	0	0	0	0	0
Bit	7	6	5	4	3	2	1	0
	OUTSET[7:0]							
Access	R/W	R/W	R/W	R/W	R/W	R/W	R/W	R/W
Reset	0	0	0	0	0	0	0	0

### Bits 31:0 – OUTSET[31:0]: PORT Data Output Value Set

Writing '0' to a bit has no effect.

Writing '1' to a bit will set the corresponding bit in the OUT register, which sets the output drive level high for I/O pins configured as outputs via the Data Direction register (DIR). For pins configured as inputs via Data Direction register (DIR) with pull enabled via the Pull Enable register (PULLEN), these bits will set the input pull direction to an internal pull-up.

Value	Description
0	The corresponding I/O pin in the group will keep its configuration.
1	The corresponding I/O pin output is driven high, or the input is connected to an internal pull-up.

### 29.9.8 Data Output Value Toggle

This register allows the user to toggle the drive level of one or more output I/O pins, without doing a read-modify-write operation. Changes in this register will also be reflected in the Data Output Value (OUT), Data Output Value Set (OUTSET) and Data Output Value Clear (OUTCLR) registers.



**Tip:** The I/O pins are assembled in pin groups ("PORT groups") with up to 32 pins. Group 0 consists of the PA pins, group 1 is for the PB pins, etc. Each pin group has its own PORT registers. For example, the register address offset for the Data Direction (DIR) register for group 0 (PA00 to PA31) is 0x00, and the register address offset for the DIR register for group 1 (PB00 to PB31) is 0x80.

**Name:** OUTTGL  
**Offset:** 0x1C [ID-000011ca]  
**Reset:** 0x00000000  
**Property:** PAC Write-Protection

Bit	31	30	29	28	27	26	25	24
	OUTTGL[31:24]							
Access	R/W	R/W	R/W	R/W	R/W	R/W	R/W	R/W
Reset	0	0	0	0	0	0	0	0
Bit	23	22	21	20	19	18	17	16
	OUTTGL[23:16]							
Access	R/W	R/W	R/W	R/W	R/W	R/W	R/W	R/W
Reset	0	0	0	0	0	0	0	0
Bit	15	14	13	12	11	10	9	8
	OUTTGL[15:8]							
Access	R/W	R/W	R/W	R/W	R/W	R/W	R/W	R/W
Reset	0	0	0	0	0	0	0	0
Bit	7	6	5	4	3	2	1	0
	OUTTGL[7:0]							
Access	R/W	R/W	R/W	R/W	R/W	R/W	R/W	R/W
Reset	0	0	0	0	0	0	0	0

### Bits 31:0 – OUTTGL[31:0]: PORT Data Output Value Toggle

Writing '0' to a bit has no effect.

Writing '1' to a bit will toggle the corresponding bit in the OUT register, which inverts the output drive level for I/O pins configured as outputs via the Data Direction register (DIR). For pins configured as inputs via Data Direction register (DIR) with pull enabled via the Pull Enable register (PULLEN), these bits will toggle the input pull direction.

Value	Description
0	The corresponding I/O pin in the PORT group will keep its configuration.
1	The corresponding OUT bit value is toggled.

## 29.9.9 Data Input Value



**Tip:** The I/O pins are assembled in pin groups ("PORT groups") with up to 32 pins. Group 0 consists of the PA pins, group 1 is for the PB pins, etc. Each pin group has its own PORT registers. For example, the register address offset for the Data Direction (DIR) register for group 0 (PA00 to PA31) is 0x00, and the register address offset for the DIR register for group 1 (PB00 to PB31) is 0x80.

**Name:** IN  
**Offset:** 0x20 [ID-000011ca]  
**Reset:** 0x00000000  
**Property:** -



Bit	31	30	29	28	27	26	25	24
	IN[31:24]							
Access	R	R	R	R	R	R	R	R
Reset	0	0	0	0	0	0	0	0
Bit	23	22	21	20	19	18	17	16
	IN[23:16]							
Access	R	R	R	R	R	R	R	R
Reset	0	0	0	0	0	0	0	0
Bit	15	14	13	12	11	10	9	8
	IN[15:8]							
Access	R	R	R	R	R	R	R	R
Reset	0	0	0	0	0	0	0	0
Bit	7	6	5	4	3	2	1	0
	IN[7:0]							
Access	R	R	R	R	R	R	R	R
Reset	0	0	0	0	0	0	0	0

**Bits 31:0 – IN[31:0]: PORT Data Input Value**

These bits are cleared when the corresponding I/O pin input sampler detects a logical low level on the input pin.

These bits are set when the corresponding I/O pin input sampler detects a logical high level on the input pin.

**29.9.10 Control**



**Tip:** The I/O pins are assembled in pin groups (“PORT groups”) with up to 32 pins. Group 0 consists of the PA pins, group 1 is for the PB pins, etc. Each pin group has its own PORT registers. For example, the register address offset for the Data Direction (DIR) register for group 0 (PA00 to PA31) is 0x00, and the register address offset for the DIR register for group 1 (PB00 to PB31) is 0x80.

**Name:** CTRL  
**Offset:** 0x24 [ID-000011ca]  
**Reset:** 0x00000000  
**Property:** PAC Write-Protection

Bit	31	30	29	28	27	26	25	24
	SAMPLING[31:24]							
Access	W	W	W	W	W	W	W	W
Reset	0	0	0	0	0	0	0	0
Bit	23	22	21	20	19	18	17	16
	SAMPLING[23:16]							
Access	W	W	W	W	W	W	W	W
Reset	0	0	0	0	0	0	0	0
Bit	15	14	13	12	11	10	9	8
	SAMPLING[15:8]							
Access	W	W	W	W	W	W	W	W
Reset	0	0	0	0	0	0	0	0
Bit	7	6	5	4	3	2	1	0
	SAMPLING[7:0]							
Access	W	W	W	W	W	W	W	W
Reset	0	0	0	0	0	0	0	0

### Bits 31:0 – SAMPLING[31:0]: Input Sampling Mode

Configures the input sampling functionality of the I/O pin input samplers, for pins configured as inputs via the Data Direction register (DIR).

The input samplers are enabled and disabled in sub-groups of eight. Thus if any pins within a byte request continuous sampling, all pins in that eight pin sub-group will be continuously sampled.

Value	Description
0	The I/O pin input synchronizer is disabled.
1	The I/O pin input synchronizer is enabled.

## 29.9.11 Write Configuration



**Tip:** The I/O pins are assembled in pin groups (“PORT groups”) with up to 32 pins. Group 0 consists of the PA pins, group 1 is for the PB pins, etc. Each pin group has its own PORT registers. For example, the register address offset for the Data Direction (DIR) register for group 0 (PA00 to PA31) is 0x00, and the register address offset for the DIR register for group 1 (PB00 to PB31) is 0x80.

This write-only register is used to configure several pins simultaneously with the same configuration and/or peripheral multiplexing.

In order to avoid side effect of non-atomic access, 8-bit or 16-bit writes to this register will have no effect. Reading this register always returns zero.

**Name:** WRCONFIG  
**Offset:** 0x28 [ID-000011ca]  
**Reset:** 0x00000000  
**Property:** PAC Write-Protection

Bit	31	30	29	28	27	26	25	24
	HWSEL	WRPINCFCG		WRPMUX	PMUX[3:0]			
Access	W	W		W	W	W	W	W
Reset	0	0		0	0	0	0	0
Bit	23	22	21	20	19	18	17	16
		DRVSTR				PULLEN	INEN	PMUXEN
Access		W				W	W	W
Reset		0				0	0	0
Bit	15	14	13	12	11	10	9	8
	PINMASK[15:8]							
Access	W	W	W	W	W	W	W	W
Reset	0	0	0	0	0	0	0	0
Bit	7	6	5	4	3	2	1	0
	PINMASK[7:0]							
Access	W	W	W	W	W	W	W	W
Reset	0	0	0	0	0	0	0	0

**Bit 31 – HWSEL: Half-Word Select**

This bit selects the half-word field of a 32-PORT group to be reconfigured in the atomic write operation.

This bit will always read as zero.

Value	Description
0	The lower 16 pins of the PORT group will be configured.
1	The upper 16 pins of the PORT group will be configured.

**Bit 30 – WRPINCFCG: Write PINCFG**

This bit determines whether the atomic write operation will update the Pin Configuration register (PINCFGy) or not for all pins selected by the WRCONFIG.PINMASK and WRCONFIG.HWSEL bits.

Writing '0' to this bit has no effect.

Writing '1' to this bit updates the configuration of the selected pins with the written WRCONFIG.DRVSTR, WRCONFIG.PULLEN, WRCONFIG.INEN, WRCONFIG.PMUXEN, and WRCONFIG.PINMASK values.

This bit will always read as zero.

Value	Description
0	The PINCFGy registers of the selected pins will not be updated.
1	The PINCFGy registers of the selected pins will be updated.

**Bit 28 – WRPMUX: Write PMUX**

This bit determines whether the atomic write operation will update the Peripheral Multiplexing register (PMUXn) or not for all pins selected by the WRCONFIG.PINMASK and WRCONFIG.HWSEL bits.

Writing '0' to this bit has no effect.

Writing '1' to this bit updates the pin multiplexer configuration of the selected pins with the written WRCONFIG.PMUX value.

This bit will always read as zero.

Value	Description
0	The PMUXn registers of the selected pins will not be updated.
1	The PMUXn registers of the selected pins will be updated.

### Bits 27:24 – PMUX[3:0]: Peripheral Multiplexing

These bits determine the new value written to the Peripheral Multiplexing register (PMUXn) for all pins selected by the WRCONFIG.PINMASK and WRCONFIG.HWSEL bits, when the WRCONFIG.WRPMUX bit is set.

These bits will always read as zero.

### Bit 22 – DRVSTR: Output Driver Strength Selection

This bit determines the new value written to PINCFGy.DRVSTR for all pins selected by the WRCONFIG.PINMASK and WRCONFIG.HWSEL bits, when the WRCONFIG.WRPINCFG bit is set.

This bit will always read as zero.

### Bit 18 – PULLEN: Pull Enable

This bit determines the new value written to PINCFGy.PULLEN for all pins selected by the WRCONFIG.PINMASK and WRCONFIG.HWSEL bits, when the WRCONFIG.WRPINCFG bit is set.

This bit will always read as zero.

### Bit 17 – INEN: Input Enable

This bit determines the new value written to PINCFGy.INEN for all pins selected by the WRCONFIG.PINMASK and WRCONFIG.HWSEL bits, when the WRCONFIG.WRPINCFG bit is set.

This bit will always read as zero.

### Bit 16 – PMUXEN: Peripheral Multiplexer Enable

This bit determines the new value written to PINCFGy.PMUXEN for all pins selected by the WRCONFIG.PINMASK and WRCONFIG.HWSEL bits, when the WRCONFIG.WRPINCFG bit is set.

This bit will always read as zero.

### Bits 15:0 – PINMASK[15:0]: Pin Mask for Multiple Pin Configuration

These bits select the pins to be configured within the half-word group selected by the WRCONFIG.HWSEL bit.

These bits will always read as zero.

Value	Description
0	The configuration of the corresponding I/O pin in the half-word group will be left unchanged.
1	The configuration of the corresponding I/O pin in the half-word PORT group will be updated.

## 29.9.12 Event Input Control



**Tip:** The I/O pins are assembled in pin groups ("PORT groups") with up to 32 pins. Group 0 consists of the PA pins, group 1 is for the PB pins, etc. Each pin group has its own PORT registers. For example, the register address offset for the Data Direction (DIR) register for group 0 (PA00 to PA31) is 0x00, and the register address offset for the DIR register for group 1 (PB00 to PB31) is 0x80.

There are up to four input event pins for each PORT group. Each byte of this register addresses one Event input pin.

**Name:** EVCTRL  
**Offset:** 0x2C [ID-000011ca]  
**Reset:** 0x00000000  
**Property:** PAC Write-Protection

	Bit	31	30	29	28	27	26	25	24
		PORTEIx		EVACTx[1:0]		PIDx[4:0]			
Access		R/W	R/W	R/W	R/W	R/W	R/W	R/W	R/W
Reset		0	0	0	0	0	0	0	0
	Bit	23	22	21	20	19	18	17	16
		PORTEIx		EVACTx[1:0]		PIDx[4:0]			
Access		R/W	R/W	R/W	R/W	R/W	R/W	R/W	R/W
Reset		0	0	0	0	0	0	0	0
	Bit	15	14	13	12	11	10	9	8
		PORTEIx		EVACTx[1:0]		PIDx[4:0]			
Access		R/W	R/W	R/W	R/W	R/W	R/W	R/W	R/W
Reset		0	0	0	0	0	0	0	0
	Bit	7	6	5	4	3	2	1	0
		PORTEIx		EVACTx[1:0]		PIDx[4:0]			
Access		R/W	R/W	R/W	R/W	R/W	R/W	R/W	R/W
Reset		0	0	0	0	0	0	0	0

**Bits 31,23,15,7 – PORTEIx: PORT Event Input Enable x [x = 3..0]**

Value	Description
0	The event action x (EVACTx) will not be triggered on any incoming event.
1	The event action x (EVACTx) will be triggered on any incoming event.

**Bits 30:29, 22:21,14:13,6:5 – EVACTx: PORT Event Action x [x = 3..0]**

These bits define the event action the PORT will perform on event input x. See also [Table 29-4](#).

**Bits 28:24,20:16,12:8,4:0 – PIDx: PORT Event Pin Identifier x [x = 3..0]**

These bits define the I/O pin on which the event action will be performed, according to [Table 29-5](#).

**Table 29-4. PORT Event x Action ( x = [3..0] )**

Value	Name	Description
0x0	OUT	Output register of pin will be set to level of event.
0x1	SET	Set output register of pin on event.

Value	Name	Description
0x2	CLR	Clear output register of pin on event.
0x3	TGL	Toggle output register of pin on event.

**Table 29-5. PORT Event x Pin Identifier ( x = [3..0] )**

Value	Name	Description
0x0	PIN0	Event action to be executed on PIN 0.
0x1	PIN1	Event action to be executed on PIN 1.
...	...	...
0x31	PIN31	Event action to be executed on PIN 31.

### 29.9.13 Peripheral Multiplexing n



**Tip:** The I/O pins are assembled in pin groups ("PORT groups") with up to 32 pins. Group 0 consists of the PA pins, group 1 is for the PB pins, etc. Each pin group has its own PORT registers. For example, the register address offset for the Data Direction (DIR) register for group 0 (PA00 to PA31) is 0x00, and the register address offset for the DIR register for group 1 (PB00 to PB31) is 0x80.

There are up to 16 Peripheral Multiplexing registers in each group, one for every set of two subsequent I/O lines. The n denotes the number of the set of I/O lines.

**Name:** PMUX  
**Offset:** 0x30 + n\*0x01 [n=0..15]  
**Reset:** 0x00  
**Property:** PAC Write-Protection

Bit	7	6	5	4	3	2	1	0
	PMUXO[3:0]				PMUXE[3:0]			
Access	R/W	R/W	R/W	R/W	R/W	R/W	R/W	R/W
Reset	0	0	0	0	0	0	0	0

#### Bits 7:4 – PMUXO[3:0]: Peripheral Multiplexing for Odd-Numbered Pin

These bits select the peripheral function for odd-numbered pins ( $2*n + 1$ ) of a PORT group, if the corresponding PINCFGy.PMUXEN bit is '1'.

Not all possible values for this selection may be valid. For more details, refer to the *I/O Multiplexing and Considerations*.

PMUXO[3:0]	Name	Description
0x0	A	Peripheral function A selected
0x1	B	Peripheral function B selected
0x2	C	Peripheral function C selected
0x3	D	Peripheral function D selected
0x4	E	Peripheral function E selected
0x5	F	Peripheral function F selected
0x6	G	Peripheral function G selected
0x7	H	Peripheral function H selected
0x8	I	Peripheral function I selected
0x9-0xF	-	Reserved

### Bits 3:0 – PMUXE[3:0]: Peripheral Multiplexing for Even-Numbered Pin

These bits select the peripheral function for even-numbered pins ( $2^n$ ) of a PORT group, if the corresponding PINCFGy.PMUXEN bit is '1'.

Not all possible values for this selection may be valid. For more details, refer to the *I/O Multiplexing and Considerations*.

PMUXE[3:0]	Name	Description
0x0	A	Peripheral function A selected
0x1	B	Peripheral function B selected
0x2	C	Peripheral function C selected
0x3	D	Peripheral function D selected
0x4	E	Peripheral function E selected
0x5	F	Peripheral function F selected
0x6	G	Peripheral function G selected
0x7	H	Peripheral function H selected
0x8	I	Peripheral function I selected
0x9-0xF	-	Reserved

## 29.9.14 Pin Configuration



**Tip:** The I/O pins are assembled in pin groups ("PORT groups") with up to 32 pins. Group 0 consists of the PA pins, group 1 is for the PB pins, etc. Each pin group has its own PORT registers. For example, the register address offset for the Data Direction (DIR) register for group 0 (PA00 to PA31) is 0x00, and the register address offset for the DIR register for group 1 (PB00 to PB31) is 0x80.

There are up to 32 Pin Configuration registers in each PORT group, one for each I/O line.

**Name:** PINCFG  
**Offset:** 0x40 + n\*0x01 [n=0..31]  
**Reset:** 0x00  
**Property:** PAC Write-Protection

	7	6	5	4	3	2	1	0
		DRVSTR				PULLEN	INEN	PMUXEN
Access		R/W				R/W	R/W	R/W
Reset		0				0	0	0

### Bit 6 – DRVSTR: Output Driver Strength Selection

This bit controls the output driver strength of an I/O pin configured as an output.

Value	Description
0	Pin drive strength is set to normal drive strength.
1	Pin drive strength is set to stronger drive strength.

### Bit 2 – PULLEN: Pull Enable

This bit enables the internal pull-up or pull-down resistor of an I/O pin configured as an input.

Value	Description
0	Internal pull resistor is disabled, and the input is in a high-impedance configuration.
1	Internal pull resistor is enabled, and the input is driven to a defined logic level in the absence of external input.

### Bit 1 – INEN: Input Enable

This bit controls the input buffer of an I/O pin configured as either an input or output.

Writing a zero to this bit disables the input buffer completely, preventing read-back of the physical pin state when the pin is configured as either an input or output.

Value	Description
0	Input buffer for the I/O pin is disabled, and the input value will not be sampled.
1	Input buffer for the I/O pin is enabled, and the input value will be sampled when required.

### Bit 0 – PMUXEN: Peripheral Multiplexer Enable

This bit enables or disables the peripheral multiplexer selection set in the Peripheral Multiplexing register (PMUXn) to enable or disable alternative peripheral control over an I/O pin direction and output drive value.

Writing a zero to this bit allows the PORT to control the pad direction via the Data Direction register (DIR) and output drive value via the Data Output Value register (OUT). The peripheral multiplexer value in PMUXn is ignored. Writing '1' to this bit enables the peripheral selection in PMUXn to control the pad. In this configuration, the physical pin state may still be read from the Data Input Value register (IN) if PINCFGn.INEN is set.



Value	Description
0	The peripheral multiplexer selection is disabled, and the PORT registers control the direction and output drive value.
1	The peripheral multiplexer selection is enabled, and the selected peripheral function controls the direction and output drive value.

## 30. EVSYS – Event System

### 30.1 Overview

The Event System (EVSYS) allows autonomous, low-latency and configurable communication between peripherals.

Several peripherals can be configured to generate and/or respond to signals known as events. The exact condition to generate an event, or the action taken upon receiving an event, is specific to each peripheral. Peripherals that respond to events are called event users. Peripherals that generate events are called event generators. A peripheral can have one or more event generators and can have one or more event users.

Communication is made without CPU intervention and without consuming system resources such as bus or RAM bandwidth. This reduces the load on the CPU and other system resources, compared to a traditional interrupt-based system.

### 30.2 Features

- 6 configurable event channels, where each channel can:
  - Be connected to any event generator.
  - Provide a pure asynchronous, resynchronized or synchronous path
- 68 event generators.
- 31 event users.
- Configurable edge detector.
- Peripherals can be event generators, event users, or both.
- SleepWalking and interrupt for operation in sleep modes.
- Software event generation.
- Each event user can choose which channel to respond to.

### 30.3 Block Diagram

Figure 30-1. Event System Block Diagram



## 30.4 Signal Description

Not applicable.

## 30.5 Product Dependencies

In order to use this peripheral, other parts of the system must be configured correctly, as described below.

### 30.5.1 I/O Lines

Not applicable.

### 30.5.2 Power Management

The EVSYS can be used to wake up the CPU from all sleep modes, even if the clock used by the EVSYS channel and the EVSYS bus clock are disabled. Refer to the *PM – Power Manager* for details on the different sleep modes.

Although the clock for the EVSYS is stopped, the device still can wake up the EVSYS clock. Some event generators can generate an event when their clocks are stopped. The generic clock for the channel (GCLK\_EVSYS\_CHANNEL\_n) will be restarted if that channel uses a synchronized path or a resynchronized path. It does not need to wake the system from sleep.

#### Related Links

[PM – Power Manager](#)

### 30.5.3 Clocks

The EVSYS bus clock (CLK\_EVSYS\_APB) can be enabled and disabled in the Main Clock module, and the default state of CLK\_EVSYS\_APB can be found in *Peripheral Clock Masking*.

Each EVSYS channel has a dedicated generic clock (GCLK\_EVSYS\_CHANNEL\_n). These are used for event detection and propagation for each channel. These clocks must be configured and enabled in the generic clock controller before using the EVSYS. Refer to *GCLK - Generic Clock Controller* for details.

#### Related Links

[Peripheral Clock Masking](#)

[GCLK - Generic Clock Controller](#)

### 30.5.4 DMA

Not applicable.

### 30.5.5 Interrupts

The interrupt request line is connected to the Interrupt Controller. Using the EVSYS interrupts requires the interrupt controller to be configured first. Refer to *Nested Vector Interrupt Controller* for details.

#### Related Links

[Nested Vector Interrupt Controller](#)

### 30.5.6 Events

Not applicable.

### 30.5.7 Debug Operation

When the CPU is halted in debug mode, this peripheral will continue normal operation. If the peripheral is configured to require periodical service by the CPU through interrupts or similar, improper operation or

data loss may result during debugging. This peripheral can be forced to halt operation during debugging - refer to the Debug Control (DBGCTRL) register for details.

## 30.5.8 Register Access Protection

Registers with write-access can be optionally write-protected by the Peripheral Access Controller (PAC), except for the following:

- Channel Status (CHSTATUS)
- Interrupt Flag Status and Clear register (INTFLAG)

**Note:** Optional write-protection is indicated by the "PAC Write-Protection" property in the register description.

When the CPU is halted in debug mode, all write-protection is automatically disabled. Write-protection does not apply for accesses through an external debugger.

## 30.5.9 Analog Connections

Not applicable.

## 30.6 Functional Description

### 30.6.1 Principle of Operation

The Event System consists of several channels which route the internal events from peripherals (generators) to other internal peripherals or IO pins (users). Each event generator can be selected as source for multiple channels, but a channel cannot be set to use multiple event generators at the same time.

A channel path can be configured in asynchronous, synchronous or re-synchronized mode of operation. The mode of operation must be selected based on the requirements of the application.

When using synchronous or resynchronized path, the Event System includes options to transfer events to users when rising, falling or both edges are detected on on event generators.

For further details, refer to Channel Path section of this chapter.

### 30.6.2 Basic Operation

#### 30.6.2.1 Initialization

Before enabling event routing within the system, the Event Users Multiplexer and Event Channels must be selected in the Event System (EVSYS), and the two peripherals that generate and use the event have to be configured. The recommended sequence is:

1. In the event generator peripheral, enable output of event by writing a '1' to the respective Event Output Enable bit ("EO") in the peripheral's Event Control register (e.g., TCC.EVCTRL.MCEO1, AC.EVCTRL.WINEO0, RTC.EVCTRL.OVFEO).
2. Configure the EVSYS:
  - 2.1. Configure the Event User multiplexer by writing the respective EVSYS.USERm register, see also [User Multiplexer Setup](#).
  - 2.2. Configure the Event Channel by writing the respective EVSYS.CHANNELn register, see also [Event System Channel](#).
3. Configure the action to be executed by the event user peripheral by writing to the Event Action bits (EVACT) in the respective Event control register (e.g., TC.EVCTRL.EVACT, PDEC.EVCTRL.EVACT). Note: not all peripherals require this step.

4. In the event user peripheral, enable event input by writing a '1' to the respective Event Input Enable bit ("EI") in the peripheral's Event Control register (e.g., AC.EVCTRL.IVEIO, ADC.EVCTRL.STARTEI).

### 30.6.2.2 Enabling, Disabling, and Resetting

The EVSYS is always enabled.

The EVSYS is reset by writing a '1' to the Software Reset bit in the Control A register (CTRLA.SWRST). All registers in the EVSYS will be reset to their initial state and all ongoing events will be canceled.

Refer to [CTRLA.SWRST](#) register for details.

### 30.6.2.3 User Multiplexer Setup

The user multiplexer defines the channel to be connected to which event user. Each user multiplexer is dedicated to one event user. A user multiplexer receives all event channels output and must be configured to select one of these channels, as shown in Block Diagram section. The channel is selected with the Channel bit group in the User register (USERm.CHANNEL).

The user multiplexer must always be configured before the channel. A list of all user multiplexers is found in the User (USERm) register description.

#### Related Links

[USERm](#)

### 30.6.2.4 Event System Channel

An event channel can select one event from a list of event generators. Depending on configuration, the selected event could be synchronized, resynchronized or asynchronously sent to the users. When synchronization or resynchronization is required, the channel includes an internal edge detector, allowing the Event System to generate internal events when rising, falling or both edges are detected on the selected event generator.

An event channel is able to generate internal events for the specific software commands. A channel block diagram is shown in *Block Diagram* section.

### 30.6.2.5 Event Generators

Each event channel can receive the events from all event generators. All event generators are listed in the Event Generator bit field in the Channel n register (CHANNELn.EVGEN). For details on event generation, refer to the corresponding module chapter. The channel event generator is selected by the Event Generator bit group in the Channel register (CHANNELn.EVGEN). By default, the channels are not connected to any event generators (ie, CHANNELn.EVGEN = 0)

### 30.6.2.6 Channel Path

There are three different ways to propagate the event from an event generator:

- Asynchronous path
- Synchronous path
- Resynchronized path

The path is decided by writing to the Path Selection bit group of the Channel register (CHANNELn.PATH).

#### Asynchronous Path

When using the asynchronous path, the events are propagated from the event generator to the event user without intervention from the Event System. The GCLK for this channel (GCLK\_EVSYS\_CHANNEL\_n) is not mandatory, meaning that an event will be propagated to the user without any clock latency.

When the asynchronous path is selected, the channel cannot generate any interrupts, and the Channel Status register (CHSTATUS) is always zero. The edge detection is not required and must be disabled by software. Each peripheral event user has to select which event edge must trigger internal actions. For further details, refer to each peripheral chapter description.

## Synchronous Path

The synchronous path should be used when the event generator and the event channel share the same generator for the generic clock. If they do not share the same clock, a logic change from the event generator to the event channel might not be detected in the channel, which means that the event will not be propagated to the event user. For details on generic clock generators, refer to *GCLK - Generic Clock Controller*.

When using the synchronous path, the channel is able to generate interrupts. The channel busy n bit in the Channel Status register (CHSTATUS.CHBUSYn) are also updated and available for use.

## Resynchronized Path

The resynchronized path are used when the event generator and the event channel do not share the same generator for the generic clock. When the resynchronized path is used, resynchronization of the event from the event generator is done in the channel. For details on generic clock generators, refer to *GCLK - Generic Clock Controller*.

When the resynchronized path is used, the channel is able to generate interrupts. The channel busy n bits in the Channel Status register (CHSTATUS.CHBUSYn) are also updated and available for use.

## Related Links

[GCLK - Generic Clock Controller](#)

### 30.6.2.7 Edge Detection

When synchronous or resynchronized paths are used, edge detection must be enabled. The event system can execute edge detection in three different ways:

- Generate an event only on the rising edge
- Generate an event only on the falling edge
- Generate an event on rising and falling edges.

Edge detection is selected by writing to the Edge Selection bit group of the Channel register (CHANNELn.EDGSEL).

### 30.6.2.8 Event Latency

An event from an event generator is propagated to an event user with different latency, depending on event channel configuration.

- Asynchronous Path: The maximum routing latency of an external event is related to the internal signal routing and it is device dependent.
- Resynchronized Path: The maximum routing latency of an external event is three GCLK\_EVSYS\_CHANNEL\_n clock cycles.

The maximum propagation latency of a user event to the peripheral clock core domain is three peripheral clock cycles.

The event generators, event channel and event user clocks ratio must be selected in relation with the internal event latency constraints. Events propagation or event actions in peripherals may be lost if the clock setup violates the internal latencies.

## 30.6.2.9 The Overrun Channel n Interrupt

The Overrun Channel n interrupt flag in the Interrupt Flag Status and Clear register (INTFLAG.OVRn) will be set, and the optional interrupt will be generated in the following cases:

- One or more event users on channel n is not ready when there is a new event.
- An event occurs when the previous event on channel m has not been handled by all event users connected to that channel.

The flag will only be set when using resynchronized paths. In the case of asynchronous path, the INTFLAG.OVRn is always read as zero.

## 30.6.2.10 The Event Detected Channel n Interrupt

The Event Detected Channel n interrupt flag in the Interrupt Flag Status and Clear register (INTFLAG.EVDn) is set when an event coming from the event generator configured on channel n is detected.

The flag will only be set when using a resynchronized path. In the case of asynchronous path, the INTFLAG.EVDn is always zero.

## 30.6.2.11 Channel Status

The Channel Status register (CHSTATUS) shows the status of the channels when using a synchronous or resynchronized path. There are two different status bits in CHSTATUS for each of the available channels:

- The CHSTATUS.CHBUSYn bit will be set when an event on the corresponding channel n has not been handled by all event users connected to that channel.
- The CHSTATUS.USRRDYn bit will be set when all event users connected to the corresponding channel are ready to handle incoming events on that channel.

## 30.6.2.12 Software Event

A software event can be initiated on a channel by setting the Channel n bit in the Software Event register (SWEVT.CHANNELn) to '1'. Then the software event can be serviced as any event generator; i.e., when the bit is set to '1', an event will be generated on the respective channel.

## 30.6.3 Interrupts

The EVSYS has the following interrupt sources:

- Overrun Channel n interrupt (OVRn): for details, refer to [The Overrun Channel n Interrupt](#).
- Event Detected Channel n interrupt (EVDn): for details, refer to [The Event Detected Channel n Interrupt](#).

These interrupts events are asynchronous wake-up sources. See *Sleep Mode Controller*. Each interrupt source has an interrupt flag which is in the Interrupt Flag Status and Clear (INTFLAG) register. The flag is set when the interrupt is issued. Each interrupt event can be individually enabled by setting a '1' to the corresponding bit in the Interrupt Enable Set (INTENSET) register, and disabled by setting a '1' to the corresponding bit in the Interrupt Enable Clear (INTENCLR) register. An interrupt event is generated when the interrupt flag is set and the corresponding interrupt is enabled. The interrupt event works until the interrupt flag is cleared, the interrupt is disabled, or the Event System is reset. See [INTFLAG](#) for details on how to clear interrupt flags.

All interrupt events from the peripheral are ORed together on system level to generate one combined interrupt request to the NVIC. Refer to the *Nested Vector Interrupt Controller* for details. The event user must read the INTFLAG register to determine what the interrupt condition is.

Note that interrupts must be globally enabled for interrupt requests to be generated. Refer to *Nested Vector Interrupt Controller* for details.

### Related Links

## Sleep Mode Controller

### 30.6.4 Sleep Mode Operation

The EVSYS can generate interrupts to wake up the device from any sleep mode.

To be able to run in standby, the Run in Standby bit in the Channel register (CHANNELn.RUNSTDBY) must be set to '1'. When the Generic Clock On Demand bit in Channel register (CHANNELn.ONDEMAND) is set to '1' and the event generator is detected, the event channel will request its clock (GCLK\_EVSYS\_CHANNEL\_n). The event latency for a resynchronized channel path will increase by two GCLK\_EVSYS\_CHANNEL\_n clock (i.e., up to five GCLK\_EVSYS\_CHANNEL\_n clock cycles).

A channel will behave differently in different sleep modes regarding to CHANNELn.RUNSTDBY and CHANNELn.ONDEMAND, as shown in the table below:

**Table 30-1. Event Channel Sleep Behavior**

CHANNELn.ONDEMAND	CHANNELn.RUNSTDBY	Sleep Behavior
0	0	Only run in IDLE sleep mode if an event must be propagated. Disabled in STANDBY sleep mode.
0	1	Always run in IDLE and STANDBY sleep modes.
1	0	Only run in IDLE sleep mode if an event must be propagated. Disabled in STANDBY sleep mode. Two GCLK_EVSYS_n latency added in RESYNC path before the event is propagated internally.
1	1	Always run in IDLE and STANDBY sleep modes. Two GCLK_EVSYS_n latency added in RESYNC path before the event is propagated internally.

## 30.7 Register Summary

### 30.7.1 Common Registers

Offset	Name	Bit Pos.								
0x00	CTRLA	7:0								SWRST
0x01..0x0B	Reserved									
0x0C	CHSTATUS	7:0		USRRDY5	USRRDY4	USRRDY3	USRRDY2	USRRDY1	USRRDY0	
0x0D		15:8								
0x0E		23:16		CHBUSY5	CHBUSY4	CHBUSY3	CHBUSY2	CHBUSY1	CHBUSY0	
0x0F		31:24								
0x10	INTENCLR	7:0		OVR5	OVR4	OVR3	OVR2	OVR1	OVR0	
0x11		15:8								
0x12		23:16		EVD5	EVD4	EVD3	EVD2	EVD1	EVD0	
0x13		31:24								
0x14	INTENSET	7:0		OVR5	OVR4	OVR3	OVR2	OVR1	OVR0	
0x15		15:8								
0x16		23:16		EVD5	EVD4	EVD3	EVD2	EVD1	EVD0	



Offset	Name	Bit Pos.								
0x17		31:24								
0x18	INTFLAG	7:0		OVR5	OVR4	OVR3	OVR2	OVR1	OVR0	
0x19		15:8								
0x1A		23:16		EVD5	EVD4	EVD3	EVD2	EVD1	EVD0	
0x1B		31:24								
0x1C	SWEVT	7:0	CHANNEL[5:0]							
0x1D		15:8								
0x1E		23:16								
0x1F		31:24								

## 30.7.2 CHANNELn

Offset	Name	Bit Pos.								
0x20 + 0x4*n	CHANNELn	7:0	EVGEN[7:0]							
0x21 + 0x4*n		15:8	ONDEMAND	RUNSTDBY			EDGSEL[1:0]	PATH[1:0]		
0x22 + 0x4*n		23:16								
0x23 + 0x4*n		31:24								

## 30.7.3 USERm

Offset	Name	Bit Pos.								
0x80 + 0x4*m		7:0	CHANNEL[7:0]							
0x81 + 0x4*m		15:8								
0x82 + 0x4*m		23:16								
0x83 + 0x4*m		31:24								

## 30.8 Register Description

Registers can be 8, 16, or 32 bits wide. Atomic 8-, 16-, and 32-bit accesses are supported. In addition, the 8-bit quarters and 16-bit halves of a 32-bit register, and the 8-bit halves of a 16-bit register can be accessed directly.

Optional write-protection by the Peripheral Access Controller (PAC) is denoted by the "PAC Write-Protection" property in each individual register description.

Refer to *Register Access Protection* and *PAC - Peripheral Access Controller*.

### Related Links

## PAC - Peripheral Access Controller

### 30.8.1 Control A

**Name:** CTRLA  
**Offset:** 0x00 [ID-0000120d]  
**Reset:** 0x00  
**Property:** PAC Write-Protection

Bit	7	6	5	4	3	2	1	0
								SWRST
Access								W
Reset								0

#### Bit 0 – SWRST: Software Reset

Writing '0' to this bit has no effect.

Writing '1' to this bit resets all registers in the EVSYS to their initial state.

**Note:** Before applying a Software Reset it is recommended to disable the event generators.

### 30.8.2 Channel Status

**Name:** CHSTATUS  
**Offset:** 0x0C [ID-0000120d]  
**Reset:** 0x000000FF  
**Property:** –

Bit	31	30	29	28	27	26	25	24
Access								
Reset								

Bit	23	22	21	20	19	18	17	16
			CHBUSYn	CHBUSYn	CHBUSYn	CHBUSYn	CHBUSYn	CHBUSYn
Access			R	R	R	R	R	R
Reset			0	0	0	0	0	0

Bit	15	14	13	12	11	10	9	8
Access								
Reset								

Bit	7	6	5	4	3	2	1	0
			USRRDYn	USRRDYn	USRRDYn	USRRDYn	USRRDYn	USRRDYn
Access			R	R	R	R	R	R
Reset			0	0	0	0	0	1

#### Bits 21:16 – CHBUSYn: Channel Busy n [n = 5..0]

This bit is cleared when channel n is idle.

This bit is set if an event on channel n has not been handled by all event users connected to channel n.

**Bits 5:0 – USRRDYn: User Ready for Channel n [n = 5..0]**

This bit is cleared when at least one of the event users connected to the channel is not ready.

This bit is set when all event users connected to channel n are ready to handle incoming events on channel n.

### 30.8.3 Interrupt Enable Clear

This register allows the user to disable an interrupt without doing a read-modify-write operation. Changes in this register will also be reflected in the Interrupt Enable Set register (INTENSET).

**Name:** INTENCLR  
**Offset:** 0x10 [ID-0000120d]  
**Reset:** 0x00000000  
**Property:** PAC Write-Protection

Bit	31	30	29	28	27	26	25	24
Access								
Reset								
Bit	23	22	21	20	19	18	17	16
			EVDn	EVDn	EVDn	EVDn	EVDn	EVDn
Access			R/W	R/W	R/W	R/W	R/W	R/W
Reset			0	0	0	0	0	0
Bit	15	14	13	12	11	10	9	8
Access								
Reset								
Bit	7	6	5	4	3	2	1	0
			OVRn	OVRn	OVRn	OVRn	OVRn	OVRn
Access			R/W	R/W	R/W	R/W	R/W	R/W
Reset			0	0	0	0	0	0

**Bits 21:16 – EVDn: Event Detected Channel n Interrupt Enable [n = 5..0]**

Writing '0' to this bit has no effect.

Writing '1' to this bit will clear the Event Detected Channel n Interrupt Enable bit, which disables the Event Detected Channel n interrupt.

Value	Description
0	The Event Detected Channel n interrupt is disabled.
1	The Event Detected Channel n interrupt is enabled.

**Bits 5:0 – OVRn: Overrun Channel n Interrupt Enable[n = 5..0]**

Writing '0' to this bit has no effect.

Writing '1' to this bit will clear the Overrun Channel n Interrupt Enable bit, which disables the Overrun Channel n interrupt.

Value	Description
0	The Overrun Channel n interrupt is disabled.
1	The Overrun Channel n interrupt is enabled.

### 30.8.4 Interrupt Enable Set

This register allows the user to enable an interrupt without doing a read-modify-write operation. Changes in this register will also be reflected in the Interrupt Enable Clear register (INTENCLR).

**Name:** INTENSET  
**Offset:** 0x14 [ID-0000120d]  
**Reset:** 0x00000000  
**Property:** PAC Write-Protection

Bit	31	30	29	28	27	26	25	24
Access								
Reset								
Bit	23	22	21	20	19	18	17	16
			EVDn	EVDn	EVDn	EVDn	EVDn	EVDn
Access			R/W	R/W	R/W	R/W	R/W	R/W
Reset			0	0	0	0	0	0
Bit	15	14	13	12	11	10	9	8
Access								
Reset								
Bit	7	6	5	4	3	2	1	0
			OVRn	OVRn	OVRn	OVRn	OVRn	OVRn
Access			R/W	R/W	R/W	R/W	R/W	R/W
Reset			0	0	0	0	0	0

#### Bits 21:16 – EVDn: Event Detected Channel n Interrupt Enable [n = 5..0]

Writing '0' to this bit has no effect.

Writing '1' to this bit will set the Event Detected Channel n Interrupt Enable bit, which enables the Event Detected Channel n interrupt.

Value	Description
0	The Event Detected Channel n interrupt is disabled.
1	The Event Detected Channel n interrupt is enabled.

#### Bits 5:0 – OVRn: Overrun Channel n Interrupt Enable [n = 5..0]

Writing '0' to this bit has no effect.

Writing '1' to this bit will set the Overrun Channel n Interrupt Enable bit, which disables the Overrun Channel n interrupt.

Value	Description
0	The Overrun Channel n interrupt is disabled.
1	The Overrun Channel n interrupt is enabled.

## 30.8.5 Interrupt Flag Status and Clear

**Name:** INTFLAG  
**Offset:** 0x18 [ID-0000120d]  
**Reset:** 0x00000000  
**Property:** –

Bit	31	30	29	28	27	26	25	24
Access								
Reset								
Bit	23	22	21	20	19	18	17	16
			EVDn	EVDn	EVDn	EVDn	EVDn	EVDn
Access			R/W	R/W	R/W	R/W	R/W	R/W
Reset			0	0	0	0	0	0
Bit	15	14	13	12	11	10	9	8
Access								
Reset								
Bit	7	6	5	4	3	2	1	0
			OVRn	OVRn	OVRn	OVRn	OVRn	OVRn
Access			R/W	R/W	R/W	R/W	R/W	R/W
Reset			0	0	0	0	0	0

### Bits 21:16 – EVDn: Event Detected Channel n [n=5..0]

This flag is set on the next CLK\_EVSYS\_APB cycle when an event is being propagated through the channel, and an interrupt request will be generated if INTENCLR/SET.EVDn is '1'.

When the event channel path is asynchronous, the EVDn interrupt flag will not be set.

Writing '0' to this bit has no effect.

Writing '1' to this bit will clear the Event Detected Channel n interrupt flag.

### Bits 5:0 – OVRn: Overrun Channel n [n=5..0]

This flag is set on the next CLK\_EVSYS\_APB cycle when an event is being propagated through the channel, and an interrupt request will be generated if INTENCLR/SET.OVRn is '1'.

There are two possible overrun channel conditions:

- One or more of the event users on channel n are not ready when a new event occurs.
- An event happens when the previous event on channel n has not yet been handled by all event users.

When the event channel path is asynchronous, the OVRn interrupt flag will not be set.

Writing '0' to this bit has no effect.

Writing '1' to this bit will clear the Overrun Detected Channel n interrupt flag.

### 30.8.6 Software Event

**Name:** SWEVT  
**Offset:** 0x1C [ID-0000120d]  
**Reset:** 0x00000000  
**Property:** PAC Write-Protection



**Bits 5:0 – CHANNELn: Channel n Software [n=5..0] Selection**

Writing '0' to this bit has no effect.

Writing '1' to this bit will trigger a software event for the channel n.

These bits will always return zero when read.

### 30.8.7 Channel

This register allows the user to configure channel n. To write to this register, do a single, 32-bit write of all the configuration data.

**Name:** CHANNELn  
**Offset:** 0x20+n\*0x4 [0..5n=0..11] [ID-0000120d]  
**Reset:** 0x00000000  
**Property:** PAC Write-Protection

Bit	31	30	29	28	27	26	25	24
	[Greyed out register bits]							
Access								
Reset								
Bit	23	22	21	20	19	18	17	16
	[Greyed out register bits]							
Access								
Reset								
Bit	15	14	13	12	11	10	9	8
	ONDEMAND	RUNSTDBY			EDGSEL[1:0]		PATH[1:0]	
Access	R/W	R/W			R/W	R/W	R/W	R/W
Reset	0	0			0	0	0	0
Bit	7	6	5	4	3	2	1	0
	EVGEN[7:0]							
Access	R/W	R/W	R/W	R/W	R/W	R/W	R/W	R/W
Reset	0	0	0	0	0	0	0	0

### Bit 15 – ONDEMAND: Generic Clock On Demand

Value	Description
0	Generic clock for a channel is always on, if the channel is configured and generic clock source is enabled.
1	Generic clock is requested on demand while an event is handled

### Bit 14 – RUNSTDBY: Run in Standby

This bit is used to define the behavior during standby sleep mode.

Value	Description
0	The channel is disabled in standby sleep mode.
1	The channel is not stopped in standby sleep mode and depends on the CHANNEL.ONDEMAND

### Bits 11:10 – EDGSEL[1:0]: Edge Detection Selection

These bits set the type of edge detection to be used on the channel.

These bits must be written to zero when using the asynchronous path.

Value	Name	Description
0x0	NO_EVT_OUTPUT	No event output when using the resynchronized or synchronous path
0x1	RISING_EDGE	Event detection only on the rising edge of the signal from the event generator
0x2	FALLING_EDGE	Event detection only on the falling edge of the signal from the event generator
0x3	BOTH_EDGES	Event detection on rising and falling edges of the signal from the event generator

### Bits 9:8 – PATH[1:0]: Path Selection

These bits are used to choose which path will be used by the selected channel.

The path choice can be limited by the channel source, see the table in [USERm](#).

Value	Name	Description
0x0	SYNCHRONOUS	Synchronous path
0x1	RESYNCHRONIZED	Resynchronized path
0x2	ASYNCHRONOUS	Asynchronous path
0x3	-	Reserved

### Bits 7:0 – EVGEN[7:0]: Event Generator

These bits are used to choose the event generator to connect to the selected channel.

**Table 30-2. Event Generators**

Value	Event Generator	Description
0x00	NONE	No event generator selected
0x01	OSCCTRL FAIL	XOSC Clock Failure
0x02	OSC32KCTRL FAIL	XOSC32K Clock Failure
0x03	RTC CMP0	Compare 0 (mode 0 and 1) or Alarm 0 (mode 2)
0x04	RTC CMP1	Compare 1
0x05	RTC OVF	Overflow
0x06	RTC PER0	Period 0
0x07	RTC PER1	Period 1
0x08	RTC PER2	Period 2
0x09	RTC PER3	Period 3
0x0A	RTC PER4	Period 4
0x0B	RTC PER5	Period 5
0x0C	RTC PER6	Period 6
0x0D	RTC PER7	Period 7
0x0E	EIC EXTINT0	External Interrupt 0
0x0F	EIC EXTINT1	External Interrupt 1
0x10	EIC EXTINT2	External Interrupt 2
0x11	EIC EXTINT3	External Interrupt 3
0x12	EIC EXTINT4	External Interrupt 4
0x13	EIC EXTINT5	External Interrupt 5
0x14	EIC EXTINT6	External Interrupt 6
0x15	EIC EXTINT7	External Interrupt 7
0x16	EIC EXTINT8	External Interrupt 8
0x17	EIC EXTINT9	External Interrupt 9
0x18	EIC EXTINT10	External Interrupt 10



Value	Event Generator	Description
0x19	EIC EXTINT11	External Interrupt 11
0x1A	EIC EXTINT12	External Interrupt 12
0x1B	EIC EXTINT13	External Interrupt 13
0x1C	EIC EXTINT14	External Interrupt 14
0x1D	EIC EXTINT15	External Interrupt 15
0x1E	-	Reserved
0x1F	DMAC CH0	Channel 0
0x20	DMAC CH1	Channel 1
0x21	DMAC CH2	Channel 2
0x22	DMAC CH3	Channel 3
0x23	TCC0 OVF	Overflow
0x24	TCC0 TRG	Trig
0x25	TCC0 CNT	Counter
0x26	TCC0 MC0	Match/Capture 1
0x27	TCC0 MC1	Match/Capture 1
0x28	TCC0 MC2	Match/Capture 2
0x29	TCC0 MC3	Match/Capture 3
0x2A - 0x33	-	Reserved
0x34	TC0 OVF	Overflow/Underflow
0x35	TC0 MC0	Match/Capture 0
0x36	TC0 MC1	Match/Capture 1
0x37	TC1 OVF	Overflow/Underflow
0x38	TC1 MC0	Match/Capture 0
0x39	TC1 MC1	Match/Capture 1
0x3A	TC2 OVF	Overflow/Underflow
0x3B	TC2 MC1	Match/Capture 0
0x3C	TC2 MC0	Match/Capture 1
0x3D	TC3 OVF	Overflow/Underflow
0x3E	TC3 MC0	Match/Capture 0
0x3F	TC3 MC1	Match/Capture 1
0x40	TC4 OVF	Overflow/Underflow
0x41	TC4 MC0	Match/Capture 0

Value	Event Generator	Description
0x42	TC4 MC1	Match/Capture 1
0x43	ADC0 RESRDY	Result Ready
0x44	ADC0 WINMON	Window Monitor
0x45	-	Reserved
0x46	-	Reserved
0x47	-	Reserved
0x48	-	Reserved
0x49	AC COMP0	Comparator 0
0x4A	AC COMP1	Comparator 1
0x4B	-	Reserved
0x4C	-	Reserved
0x4D	AC WIN0	Window 0
0x4E	-	Reserved
0x4F	-	Reserved
0x50	PTC EOC	End of Conversion
0x51	PTC WCOMP	Window Comparator
0x52	CCL LUTOUT0	CCL output
0x53	CCL LUTOUT1	CCL output
0x54	CCL LUTOUT2	CCL output
0x55	CCL LUT3	CCL output
0x56	PAC ACCERR	Access Error
0x57	-	Reserved
0x58	TC5 OVF	Overflow/Underflow
0x59	TC5 MC0	Match/Capture 0
0x5A	TC5 MC1	Match/Capture 1
0x5B	TC6 OVF	Overflow/Underflow
0x5C	TC6 MC0	Match/Capture 0
0x5D	TC6 MC1	Match/Capture 1
0x5E	TC7 OVF	Overflow/Underflow
0x5F	TC7 MC0	Match/Capture 0
0x60	TC7 MC1	Match/Capture 1
0x61 - 0xFF	-	Reserved

## 30.8.8 Event User m

**Name:** USERm  
**Offset:** 0x80+m\*0x4 [m=0..300..46] [ID-0000120d]  
**Reset:** 0x00000000  
**Property:** PAC Write-Protection

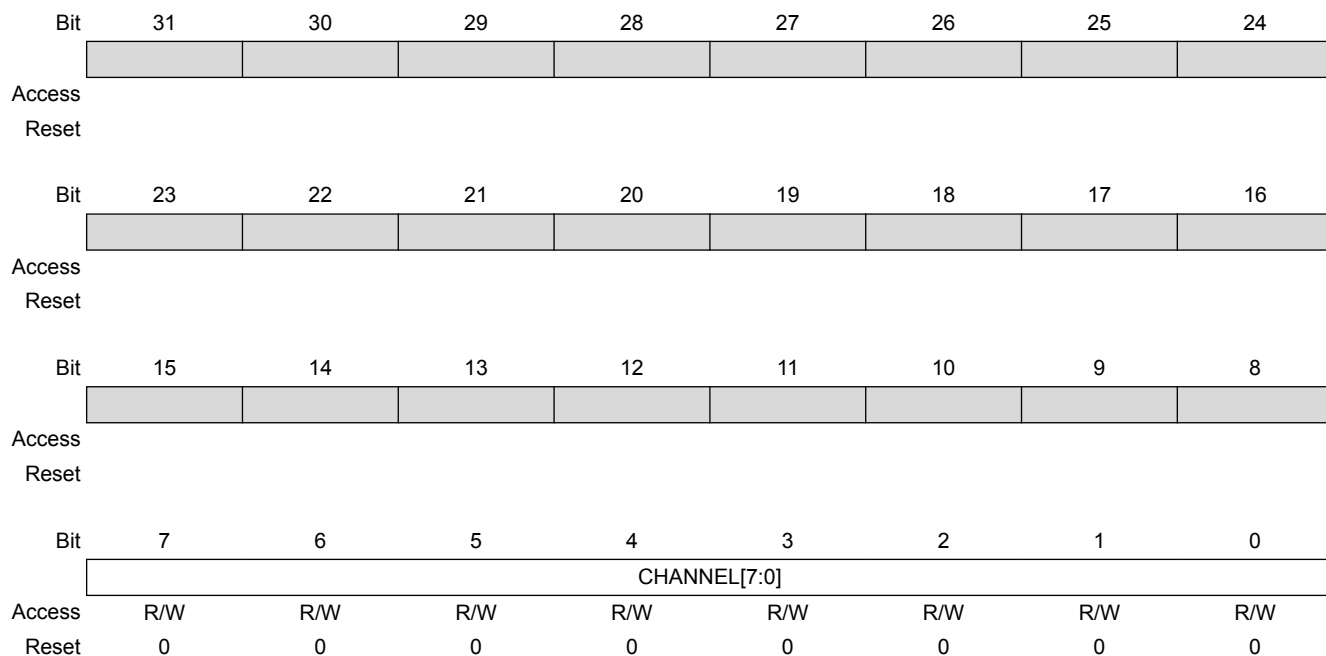

### Bits 7:0 – CHANNEL[7:0]: Channel Event Selection

These bits are used to select the channel to connect to the event user.

Note that to select channel m, the value (m+1) must be written to the USER.CHANNEL bit group.

Value	Channel Number
0x00	No channel output selected
0x01	0
0x02	1
0x03	2
0x04	3
0x05	4
0x06	5
0x07	6
0x08-0xFF	Reserved

**Table 30-3. User Multiplexer Number**

USERm	User Multiplexer	Description	Path Type
m = 0	Reserved	-	Reserved
m = 1	PORT EV0	Event 0	Asynchronous path only
m = 2	PORT EV1	Event 1	Asynchronous path only
m = 3	PORT EV2	Event 2	Asynchronous path only
m = 4	PORT EV3	Event 3	Asynchronous path only
m = 5	DMAC CH0	Channel 0	Asynchronous, synchronous, and resynchronized paths
m = 6	DMAC CH1	Channel 1	Asynchronous, synchronous, and resynchronized paths
m = 7	DMAC CH2	Channel 2	Asynchronous, synchronous, and resynchronized paths
m = 8	DMAC CH3	Channel 3	Asynchronous, synchronous, and resynchronized paths
m = 9	TCC0 EV0	-	Asynchronous, synchronous, and resynchronized paths
m = 10	TCC0 EV1	-	Asynchronous, synchronous, and resynchronized paths
m = 11	TCC0 MC0	Match/Capture 0	Asynchronous, synchronous, and resynchronized paths
m = 12	TCC0 MC1	Match/Capture 1	Asynchronous, synchronous, and resynchronized paths
m = 13	TCC0 MC2	Match/Capture 2	Asynchronous, synchronous, and resynchronized paths
m = 14	TCC0 MC3	Match/Capture 3	Asynchronous, synchronous, and resynchronized paths
m = 15	TCC1 EV0	-	Asynchronous, synchronous, and resynchronized paths

USERm	User Multiplexer	Description	Path Type
m = 16	TCC1 EV1	-	Asynchronous, synchronous, and resynchronized paths
m = 17	TCC1 MC0	Match/Capture 0	Asynchronous, synchronous, and resynchronized paths
m = 18	TCC1 MC1	Match/Capture 1	Asynchronous, synchronous, and resynchronized paths
m = 19	TCC2 EV0	-	Asynchronous, synchronous, and resynchronized paths
m = 20	TCC2 EV1	-	Asynchronous, synchronous, and resynchronized paths
m = 21	TCC2 MC0	Match/Capture 0	Asynchronous, synchronous, and resynchronized paths
m = 22	TCC2 MC1	Match/Capture 1	Asynchronous, synchronous, and resynchronized paths
m = 23	TC0	-	Asynchronous, synchronous, and resynchronized paths
m = 24	TC1	-	Asynchronous, synchronous, and resynchronized paths
m = 25	TC2	-	Asynchronous, synchronous, and resynchronized paths
m = 26	TC3	-	Asynchronous, synchronous, and resynchronized paths
m = 27	TC4	-	Asynchronous, synchronous, and resynchronized paths
m = 28	ADC0 START	ADC start conversion	Asynchronous, synchronous, and resynchronized paths
m = 29	ADC0 SYNC	Flush ADC	Asynchronous, synchronous, and resynchronized paths

USERm	User Multiplexer	Description	Path Type
m=30 to 33	Reserved	-	Reserved
m = 34	AC COMP0	Start comparator 0	Asynchronous path only
m = 35	AC COMP1	Start comparator 1	Asynchronous path only
m=36 to 38	Reserved	-	Reserved
m = 39	PTC STCONC	PTC start conversion	Asynchronous path only
m = 40	CCL LUTIN 0	CCL input	Asynchronous path only
m = 41	CCL LUTIN 1	CCL input	Asynchronous path only
m = 42	CCL LUTIN 2	CCL input	Asynchronous path only
m = 43	CCL LUTIN 3	CCL input	Asynchronous path only
m=44 to 46	Reserved	-	Reserved
m=47	TC5	-	Asynchronous, synchronous, and resynchronized paths
m=48	TC6	-	Asynchronous, synchronous, and resynchronized paths
m=49	TC7	-	Asynchronous, synchronous, and resynchronized paths
others	Reserved	-	Reserved

## 31. SERCOM – Serial Communication Interface

### 31.1 Overview

There are up to eight instances of the serial communication interface (SERCOM) peripheral.

A SERCOM can be configured to support a number of modes: I<sup>2</sup>C, SPI, and USART. When SERCOM is configured and enabled, all SERCOM resources will be dedicated to the selected mode.

The SERCOM serial engine consists of a transmitter and receiver, baud-rate generator and address matching functionality. It can use the internal generic clock or an external clock to operate in all sleep modes.

#### Related Links

[SERCOM USART – SERCOM Universal Synchronous and Asynchronous Receiver and Transmitter](#)

[SERCOM SPI – SERCOM Serial Peripheral Interface](#)

[SERCOM I2C – SERCOM Inter-Integrated Circuit](#)

### 31.2 Features

- Interface for configuring into one of the following:
  - I<sup>2</sup>C – Two-wire serial interface  
SMBus™ compatible
  - SPI – Serial peripheral interface
  - USART – Universal synchronous and asynchronous serial receiver and transmitter
- Single transmit buffer and double receive buffer
- Baud-rate generator
- Address match/mask logic
- Operational in all sleep modes
- Can be used with DMA

See the Related Links for full feature lists of the interface configurations.

#### Related Links

[SERCOM USART – SERCOM Universal Synchronous and Asynchronous Receiver and Transmitter](#)

[SERCOM SPI – SERCOM Serial Peripheral Interface](#)

[SERCOM I2C – SERCOM Inter-Integrated Circuit](#)

### 31.3 Block Diagram

Figure 31-1. SERCOM Block Diagram



### 31.4 Signal Description

See the respective SERCOM mode chapters for details.

#### Related Links

- [SERCOM USART – SERCOM Universal Synchronous and Asynchronous Receiver and Transmitter](#)
- [SERCOM SPI – SERCOM Serial Peripheral Interface](#)
- [SERCOM I2C – SERCOM Inter-Integrated Circuit](#)

### 31.5 Product Dependencies

In order to use this peripheral, other parts of the system must be configured correctly, as described below.

#### 31.5.1 I/O Lines

Using the SERCOM I/O lines requires the I/O pins to be configured using port configuration (PORT).

From *USART Block Diagram* one can see that the SERCOM has four internal pads, PAD[3:0]. The signals from I2C, SPI and USART are routed through these SERCOM pads via a multiplexer. The configuration of the multiplexer is available from the different SERCOM modes. Refer to the mode specific chapters for details.

#### Related Links

- [SERCOM USART – SERCOM Universal Synchronous and Asynchronous Receiver and Transmitter](#)
- [SERCOM SPI – SERCOM Serial Peripheral Interface](#)
- [SERCOM I2C – SERCOM Inter-Integrated Circuit](#)
- [PORT: IO Pin Controller](#)
- [Block Diagram](#)

#### 31.5.2 Power Management

The SERCOM can operate in any sleep mode where the selected clock source is running. SERCOM interrupts can be used to wake up the device from sleep modes.



## Related Links

[PM – Power Manager](#)

### 31.5.3 Clocks

The SERCOM bus clock (CLK\_SERCOMx\_APB) can be enabled and disabled in the Main Clock Controller. Refer to *Peripheral Clock Masking* for details and default status of this clock.

The SERCOM uses two generic clocks: GCLK\_SERCOMx\_CORE and GCLK\_SERCOMx\_SLOW. The core clock (GCLK\_SERCOMx\_CORE) is required to clock the SERCOM while working as a master. The slow clock (GCLK\_SERCOMx\_SLOW) is only required for certain functions. See specific mode chapters for details.

These clocks must be configured and enabled in the Generic Clock Controller (GCLK) before using the SERCOM.

The generic clocks are asynchronous to the user interface clock (CLK\_SERCOMx\_APB). Due to this asynchronicity, writing to certain registers will require synchronization between the clock domains. Refer to [Synchronization](#) for details.

## Related Links

[GCLK - Generic Clock Controller](#)

[MCLK – Main Clock](#)

### 31.5.4 DMA

The DMA request lines are connected to the DMA Controller (DMAC). The DMAC must be configured before the SERCOM DMA requests are used.

## Related Links

[DMAC – Direct Memory Access Controller](#)

### 31.5.5 Interrupts

The interrupt request line is connected to the Interrupt Controller (NVIC). The NVIC must be configured before the SERCOM interrupts are used.

## Related Links

[Nested Vector Interrupt Controller](#)

### 31.5.6 Events

Not applicable.

### 31.5.7 Debug Operation

When the CPU is halted in debug mode, this peripheral will continue normal operation. If the peripheral is configured to require periodical service by the CPU through interrupts or similar, improper operation or data loss may result during debugging. This peripheral can be forced to halt operation during debugging - refer to the Debug Control (DBGCTRL) register for details.

### 31.5.8 Register Access Protection

All registers with write-access can be write-protected optionally by the Peripheral Access Controller (PAC), except for the following registers:

- Interrupt Flag Clear and Status register (INTFLAG)
- Status register (STATUS)
- Data register (DATA)

- Address register (ADDR)

Optional write-protection by the Peripheral Access Controller (PAC) is denoted by the "PAC Write-Protection" property in each individual register description.

PAC write-protection does not apply to accesses through an external debugger.

## Related Links

[PAC - Peripheral Access Controller](#)

### 31.5.9 Analog Connections

Not applicable.

## 31.6 Functional Description

### 31.6.1 Principle of Operation

The basic structure of the SERCOM serial engine is shown in [Figure 31-2](#). Labels in capital letters are synchronous to the system clock and accessible by the CPU; labels in lowercase letters can be configured to run on the GCLK\_SERCOMx\_CORE clock or an external clock.

**Figure 31-2. SERCOM Serial Engine**



The transmitter consists of a single write buffer and a shift register.

The receiver consists of a two-level receive buffer and a shift register.

The baud-rate generator is capable of running on the GCLK\_SERCOMx\_CORE clock or an external clock.

Address matching logic is included for SPI and I<sup>2</sup>C operation.

### 31.6.2 Basic Operation

#### 31.6.2.1 Initialization

The SERCOM must be configured to the desired mode by writing the Operating Mode bits in the Control A register (CTRLA.MODE). Refer to table SERCOM Modes for details.

**Table 31-1. SERCOM Modes**

CTRLA.MODE	Description
0x0	USART with external clock
0x1	USART with internal clock
0x2	SPI in slave operation
0x3	SPI in master operation
0x4	I <sup>2</sup> C slave operation
0x5	I <sup>2</sup> C master operation
0x6-0x7	Reserved

For further initialization information, see the respective SERCOM mode chapters:

**Related Links**

[SERCOM USART – SERCOM Universal Synchronous and Asynchronous Receiver and Transmitter](#)

[SERCOM SPI – SERCOM Serial Peripheral Interface](#)

[SERCOM I2C – SERCOM Inter-Integrated Circuit](#)

**31.6.2.2 Enabling, Disabling, and Resetting**

This peripheral is enabled by writing '1' to the Enable bit in the Control A register (CTRLA.ENABLE), and disabled by writing '0' to it.

Writing '1' to the Software Reset bit in the Control A register (CTRLA.SWRST) will reset all registers of this peripheral to their initial states, except the DBGCTRL register, and the peripheral is disabled.

Refer to the CTRLA register description for details.

**31.6.2.3 Clock Generation – Baud-Rate Generator**

The baud-rate generator, as shown in [Figure 31-3](#), generates internal clocks for asynchronous and synchronous communication. The output frequency ( $f_{BAUD}$ ) is determined by the Baud register (BAUD) setting and the baud reference frequency ( $f_{ref}$ ). The baud reference clock is the serial engine clock, and it can be internal or external.

For asynchronous communication, the /16 (divide-by-16) output is used when transmitting, whereas the /1 (divide-by-1) output is used while receiving.

For synchronous communication, the /2 (divide-by-2) output is used.

This functionality is automatically configured, depending on the selected operating mode.

Figure 31-3. Baud Rate Generator



Table 31-2 contains equations for the baud rate (in bits per second) and the BAUD register value for each operating mode.

For asynchronous operation, there are two different modes: In *arithmetic mode*, the BAUD register value is 16 bits (0 to 65,535). In *fractional mode*, the BAUD register is 13 bits, while the fractional adjustment is 3 bits. In this mode the BAUD setting must be greater than or equal to 1.

For synchronous operation, the BAUD register value is 8 bits (0 to 255).

Table 31-2. Baud Rate Equations

Operating Mode	Condition	Baud Rate (Bits Per Second)	BAUD Register Value Calculation
Asynchronous Arithmetic	$f_{BAUD} \leq \frac{f_{ref}}{S}$	$f_{BAUD} = \frac{f_{ref}}{S} \left(1 - \frac{BAUD}{65536}\right)$	$BAUD = 65536 \cdot \left(1 - S \cdot \frac{f_{BAUD}}{f_{ref}}\right)$
Asynchronous Fractional	$f_{BAUD} \leq \frac{f_{ref}}{S}$	$f_{BAUD} = \frac{f_{ref}}{S \cdot \left(BAUD + \frac{FP}{8}\right)}$	$BAUD = \frac{f_{ref}}{S \cdot f_{BAUD}} - \frac{FP}{8}$
Synchronous	$f_{BAUD} \leq \frac{f_{ref}}{2}$	$f_{BAUD} = \frac{f_{ref}}{2 \cdot (BAUD + 1)}$	$BAUD = \frac{f_{ref}}{2 \cdot f_{BAUD}} - 1$

S - Number of samples per bit. Can be 16, 8, or 3.

The Asynchronous Fractional option is used for auto-baud detection.

The baud rate error is represented by the following formula:

$$\text{Error} = 1 - \left(\frac{\text{ExpectedBaudRate}}{\text{ActualBaudRate}}\right)$$

**Asynchronous Arithmetic Mode BAUD Value Selection**

The formula given for  $f_{BAUD}$  calculates the average frequency over 65536  $f_{ref}$  cycles. Although the BAUD register can be set to any value between 0 and 65536, the actual average frequency of  $f_{BAUD}$  over a single frame is more granular. The BAUD register values that will affect the average frequency over a single frame lead to an integer increase in the cycles per frame (CPF)

$$CPF = \frac{f_{ref}}{f_{BAUD}}(D + S)$$

where

- $D$  represent the data bits per frame
- $S$  represent the sum of start and first stop bits, if present.

Table 31-3 shows the BAUD register value versus baud frequency  $f_{\text{BAUD}}$  at a serial engine frequency of 48MHz. This assumes a  $D$  value of 8 bits and an  $S$  value of 2 bits (10 bits, including start and stop bits).

**Table 31-3. BAUD Register Value vs. Baud Frequency**

BAUD Register Value	Serial Engine CPF	$f_{\text{BAUD}}$ at 48MHz Serial Engine Frequency ( $f_{\text{REF}}$ )
0 – 406	160	3MHz
407 – 808	161	2.981MHz
809 – 1205	162	2.963MHz
...	...	...
65206	31775	15.11kHz
65207	31871	15.06kHz
65208	31969	15.01kHz

### 31.6.3 Additional Features

#### 31.6.3.1 Address Match and Mask

The SERCOM address match and mask feature is capable of matching either one address, two unique addresses, or a range of addresses with a mask, based on the mode selected. The match uses seven or eight bits, depending on the mode.

##### Address With Mask

An address written to the Address bits in the Address register (ADDR.ADDR), and a mask written to the Address Mask bits in the Address register (ADDR.ADDRMASK) will yield an address match. All bits that are masked are not included in the match. Note that writing the ADDR.ADDRMASK to 'all zeros' will match a single unique address, while writing ADDR.ADDRMASK to 'all ones' will result in all addresses being accepted.

**Figure 31-4. Address With Mask**



##### Two Unique Addresses

The two addresses written to ADDR and ADDRMASK will cause a match.

**Figure 31-5. Two Unique Addresses**



**Address Range**

The range of addresses between and including ADDR.ADDR and ADDR.ADDRMASK will cause a match. ADDR.ADDR and ADDR.ADDRMASK can be set to any two addresses, with ADDR.ADDR acting as the upper limit and ADDR.ADDRMASK acting as the lower limit.

**Figure 31-6. Address Range**



**31.6.4 DMA Operation**

Not applicable.

**31.6.5 Interrupts**

Interrupt sources are mode-specific. See the respective SERCOM mode chapters for details.

Each interrupt source has its own interrupt flag.

The interrupt flag in the Interrupt Flag Status and Clear register (INTFLAG) will be set when the interrupt condition is met.

Each interrupt can be individually enabled by writing '1' to the corresponding bit in the Interrupt Enable Set register (INTENSET), and disabled by writing '1' to the corresponding bit in the Interrupt Enable Clear register (INTENCLR).

An interrupt request is generated when the interrupt flag is set and the corresponding interrupt is enabled. The interrupt request remains active until either the interrupt flag is cleared, the interrupt is disabled, or the SERCOM is reset. For details on clearing interrupt flags, refer to the INTFLAG register description.

The SERCOM has one common interrupt request line for all the interrupt sources. The value of INTFLAG indicates which interrupt condition occurred. The user must read the INTFLAG register to determine which interrupt condition is present.

**Note:**

Note that interrupts must be globally enabled for interrupt requests.

**Related Links**

[Nested Vector Interrupt Controller](#)

**31.6.6 Events**

Not applicable.

**31.6.7 Sleep Mode Operation**

The peripheral can operate in any sleep mode where the selected serial clock is running. This clock can be external or generated by the internal baud-rate generator.

The SERCOM interrupts can be used to wake up the device from sleep modes. Refer to the different SERCOM mode chapters for details.

## 31.6.8 Synchronization

Due to asynchronicity between the main clock domain and the peripheral clock domains, some registers need to be synchronized when written or read.

Required write-synchronization is denoted by the "Write-Synchronized" property in the register description.

Required read-synchronization is denoted by the "Read-Synchronized" property in the register description.

### Related Links

[Register Synchronization](#)

## 32. SERCOM USART – SERCOM Universal Synchronous and Asynchronous Receiver and Transmitter

### 32.1 Overview

The Universal Synchronous and Asynchronous Receiver and Transmitter (USART) is one of the available modes in the Serial Communication Interface (SERCOM).

The USART uses the SERCOM transmitter and receiver, see [Block Diagram](#). Labels in uppercase letters are synchronous to CLK\_SERCOMx\_APB and accessible for CPU. Labels in lowercase letters can be programmed to run on the internal generic clock or an external clock.

The transmitter consists of a single write buffer, a shift register, and control logic for different frame formats. The write buffer support data transmission without any delay between frames. The receiver consists of a two-level receive buffer and a shift register. Status information of the received data is available for error checking. Data and clock recovery units ensure robust synchronization and noise filtering during asynchronous data reception.

#### Related Links

[SERCOM – Serial Communication Interface](#)

### 32.2 USART Features

- Full-duplex operation
- Asynchronous (with clock reconstruction) or synchronous operation
- Internal or external clock source for asynchronous and synchronous operation
- Baud-rate generator
- Supports serial frames with 5, 6, 7, 8 or 9 data bits and 1 or 2 stop bits
- Odd or even parity generation and parity check
- Selectable LSB- or MSB-first data transfer
- Buffer overflow and frame error detection
- Noise filtering, including false start-bit detection and digital low-pass filter
- Collision detection
- Can operate in all sleep modes
- Operation at speeds up to half the system clock for internally generated clocks
- Operation at speeds up to the system clock for externally generated clocks
- RTS and CTS flow control
- IrDA modulation and demodulation up to 115.2kbps
- LIN master support
- LIN slave support
  - Auto-baud and break character detection
- RS485 Support
- Start-of-frame detection
- Can work with DMA

#### Related Links

[Features](#)



### 32.3 Block Diagram

Figure 32-1. USART Block Diagram



### 32.4 Signal Description

Table 32-1. SERCOM USART Signals

Signal Name	Type	Description
PAD[3:0]	Digital I/O	General SERCOM pins

One signal can be mapped to one of several pins.

#### Related Links

[I/O Multiplexing and Considerations](#)

### 32.5 Product Dependencies

In order to use this peripheral, other parts of the system must be configured correctly, as described below.

#### 32.5.1 I/O Lines

Using the USART's I/O lines requires the I/O pins to be configured using the I/O Pin Controller (PORT).

When the SERCOM is used in USART mode, the SERCOM controls the direction and value of the I/O pins according to the table below. Both PORT control bits PINCFGn.PULLEN and PINCFGn.DRVSTR are still effective. If the receiver or transmitter is disabled, these pins can be used for other purposes.

Table 32-2. USART Pin Configuration

Pin	Pin Configuration
TxD	Output
RxD	Input
XCK	Output or input

The combined configuration of PORT and the Transmit Data Pinout and Receive Data Pinout bit fields in the Control A register (CTRLA.TXPO and CTRLA.RXPO, respectively) will define the physical position of the USART signals in [Table 32-2](#).

## Related Links

[PORT: IO Pin Controller](#)

### 32.5.2 Power Management

This peripheral can continue to operate in any sleep mode where its source clock is running. The interrupts can wake up the device from sleep modes.

## Related Links

[PM – Power Manager](#)

### 32.5.3 Clocks

The SERCOM bus clock (CLK\_SERCOMx\_APB) can be enabled and disabled in the Main Clock Controller. Refer to *Peripheral Clock Masking* for details and default status of this clock.

A generic clock (GCLK\_SERCOMx\_CORE) is required to clock the SERCOMx\_CORE. This clock must be configured and enabled in the Generic Clock Controller before using the SERCOMx\_CORE. Refer to *GCLK - Generic Clock Controller* for details.

This generic clock is asynchronous to the bus clock (CLK\_SERCOMx\_APB). Therefore, writing to certain registers will require synchronization to the clock domains. Refer to *Synchronization* for further details.

## Related Links

[Peripheral Clock Masking](#)

[Synchronization](#)

[GCLK - Generic Clock Controller](#)

### 32.5.4 DMA

The DMA request lines are connected to the DMA Controller (DMAC). In order to use DMA requests with this peripheral the DMAC must be configured first. Refer to *DMAC – Direct Memory Access Controller* for details.

## Related Links

[DMAC – Direct Memory Access Controller](#)

### 32.5.5 Interrupts

The interrupt request line is connected to the Interrupt Controller. In order to use interrupt requests of this peripheral, the Interrupt Controller (NVIC) must be configured first. Refer to *Nested Vector Interrupt Controller* for details.

## Related Links

[Nested Vector Interrupt Controller](#)

### 32.5.6 Events

Not applicable.

### 32.5.7 Debug Operation

When the CPU is halted in debug mode, this peripheral will continue normal operation. If the peripheral is configured to require periodical service by the CPU through interrupts or similar, improper operation or data loss may result during debugging. This peripheral can be forced to halt operation during debugging - refer to the Debug Control (DBGCTRL) register for details.

### 32.5.8 Register Access Protection

Registers with write-access can be write-protected optionally by the peripheral access controller (PAC).

PAC Write-Protection is not available for the following registers:

- Interrupt Flag Clear and Status register (INTFLAG)
- Status register (STATUS)
- Data register (DATA)

Optional PAC Write-Protection is denoted by the "PAC Write-Protection" property in each individual register description.

Write-protection does not apply to accesses through an external debugger.

**Related Links**

[PAC - Peripheral Access Controller](#)

**32.5.9 Analog Connections**

Not applicable.

**32.6 Functional Description**

**32.6.1 Principle of Operation**

The USART uses the following lines for data transfer:

- RXD for receiving
- TXD for transmitting
- XCK for the transmission clock in synchronous operation

USART data transfer is frame based. A serial frame consists of:

- 1 start bit
- From 5 to 9 data bits (MSB or LSB first)
- No, even or odd parity bit
- 1 or 2 stop bits

A frame starts with the start bit followed by one character of data bits. If enabled, the parity bit is inserted after the data bits and before the first stop bit. After the stop bit(s) of a frame, either the next frame can follow immediately, or the communication line can return to the idle (high) state. The figure below illustrates the possible frame formats. Brackets denote optional bits.

**Figure 32-2. Frame Formats**



- St** Start bit. Signal is always low.
- n, [n]** Data bits. 0 to [5..9]
- [P]** Parity bit. Either odd or even.
- Sp, [Sp]** Stop bit. Signal is always high.

**IDLE** No frame is transferred on the communication line. Signal is always high in this state.

## 32.6.2 Basic Operation

### 32.6.2.1 Initialization

The following registers are enable-protected, meaning they can only be written when the USART is disabled (CTRL.ENABLE=0):

- Control A register (CTRLA), except the Enable (ENABLE) and Software Reset (SWRST) bits.
- Control B register (CTRLB), except the Receiver Enable (RXEN) and Transmitter Enable (TXEN) bits.
- Baud register (BAUD)

When the USART is enabled or is being enabled (CTRLA.ENABLE=1), any writing attempt to these registers will be discarded. If the peripheral is being disabled, writing to these registers will be executed after disabling is completed. Enable-protection is denoted by the "Enable-Protection" property in the register description.

Before the USART is enabled, it must be configured by these steps:

1. Select either external (0x0) or internal clock (0x1) by writing the Operating Mode value in the CTRLA register (CTRLA.MODE).
2. Select either asynchronous (0) or synchronous (1) communication mode by writing the Communication Mode bit in the CTRLA register (CTRLA.CMODE).
3. Select pin for receive data by writing the Receive Data Pinout value in the CTRLA register (CTRLA.RXPO).
4. Select pads for the transmitter and external clock by writing the Transmit Data Pinout bit in the CTRLA register (CTRLA.TXPO).
5. Configure the Character Size field in the CTRLB register (CTRLB.CHSIZE) for character size.
6. Set the Data Order bit in the CTRLA register (CTRLA.DORD) to determine MSB- or LSB-first data transmission.
7. To use parity mode:
  - 7.1. Enable parity mode by writing 0x1 to the Frame Format field in the CTRLA register (CTRLA.FORM).
  - 7.2. Configure the Parity Mode bit in the CTRLB register (CTRLB.PMODE) for even or odd parity.
8. Configure the number of stop bits in the Stop Bit Mode bit in the CTRLB register (CTRLB.SBMODE).
9. When using an internal clock, write the Baud register (BAUD) to generate the desired baud rate.
10. Enable the transmitter and receiver by writing '1' to the Receiver Enable and Transmitter Enable bits in the CTRLB register (CTRLB.RXEN and CTRLB.TXEN).

### 32.6.2.2 Enabling, Disabling, and Resetting

This peripheral is enabled by writing '1' to the Enable bit in the Control A register (CTRLA.ENABLE), and disabled by writing '0' to it.

Writing '1' to the Software Reset bit in the Control A register (CTRLA.SWRST) will reset all registers of this peripheral to their initial states, except the DBGCTRL register, and the peripheral is disabled.

Refer to the CTRLA register description for details.

## 32.6.2.3 Clock Generation and Selection

For both synchronous and asynchronous modes, the clock used for shifting and sampling data can be generated internally by the SERCOM baud-rate generator or supplied externally through the XCK line.

The synchronous mode is selected by writing a '1' to the Communication Mode bit in the Control A register (CTRLA.CMODE), the asynchronous mode is selected by writing a zero to CTRLA.CMODE.

The internal clock source is selected by writing 0x1 to the Operation Mode bit field in the Control A register (CTRLA.MODE), the external clock source is selected by writing 0x0 to CTRLA.MODE.

The SERCOM baud-rate generator is configured as in the figure below.

In asynchronous mode (CTRLA.CMODE=0), the 16-bit Baud register value is used.

In synchronous mode (CTRLA.CMODE=1), the eight LSBs of the Baud register are used. Refer to *Clock Generation – Baud-Rate Generator* for details on configuring the baud rate.

**Figure 32-3. Clock Generation**



### Related Links

[Clock Generation – Baud-Rate Generator](#)

[Asynchronous Arithmetic Mode BAUD Value Selection](#)

### Synchronous Clock Operation

In synchronous mode, the CTRLA.MODE bit field determines whether the transmission clock line (XCK) serves either as input or output. The dependency between clock edges, data sampling, and data change is the same for internal and external clocks. Data input on the RxD pin is sampled at the opposite XCK clock edge when data is driven on the TxD pin.

The Clock Polarity bit in the Control A register (CTRLA.CPOL) selects which XCK clock edge is used for RxD sampling, and which is used for TxD change:

When CTRLA.CPOL is '0', the data will be changed on the rising edge of XCK, and sampled on the falling edge of XCK.

When CTRLA.CPOL is '1', the data will be changed on the falling edge of XCK, and sampled on the rising edge of XCK.

Figure 32-4. Synchronous Mode XCK Timing



When the clock is provided through XCK (CTRLA.MODE=0x0), the shift registers operate directly on the XCK clock. This means that XCK is not synchronized with the system clock and, therefore, can operate at frequencies up to the system frequency.

#### 32.6.2.4 Data Register

The USART Transmit Data register (TxDATA) and USART Receive Data register (RxDATA) share the same I/O address, referred to as the Data register (DATA). Writing the DATA register will update the TxDATA register. Reading the DATA register will return the contents of the RxDATA register.

#### 32.6.2.5 Data Transmission

Data transmission is initiated by writing the data to be sent into the DATA register. Then, the data in TxDATA will be moved to the shift register when the shift register is empty and ready to send a new frame. After the shift register is loaded with data, the data frame will be transmitted.

When the entire data frame including stop bit(s) has been transmitted and no new data was written to DATA, the Transmit Complete interrupt flag in the Interrupt Flag Status and Clear register (INTFLAG.TXC) will be set, and the optional interrupt will be generated.

The Data Register Empty flag in the Interrupt Flag Status and Clear register (INTFLAG.DRE) indicates that the register is empty and ready for new data. The DATA register should only be written to when INTFLAG.DRE is set.

#### Disabling the Transmitter

The transmitter is disabled by writing '0' to the Transmitter Enable bit in the CTRLB register (CTRLB.TXEN).

Disabling the transmitter will complete only after any ongoing and pending transmissions are completed, i.e., there is no data in the transmit shift register and TxDATA to transmit.

#### 32.6.2.6 Data Reception

The receiver accepts data when a valid start bit is detected. Each bit following the start bit will be sampled according to the baud rate or XCK clock, and shifted into the receive shift register until the first stop bit of a frame is received. The second stop bit will be ignored by the receiver.

When the first stop bit is received and a complete serial frame is present in the receive shift register, the contents of the shift register will be moved into the two-level receive buffer. Then, the Receive Complete interrupt flag in the Interrupt Flag Status and Clear register (INTFLAG.RXC) will be set, and the optional interrupt will be generated.

The received data can be read from the DATA register when the Receive Complete interrupt flag is set.

## Disabling the Receiver

Writing '0' to the Receiver Enable bit in the CTRLB register (CTRLB.RXEN) will disable the receiver, flush the two-level receive buffer, and data from ongoing receptions will be lost.

## Error Bits

The USART receiver has three error bits in the Status (STATUS) register: Frame Error (FERR), Buffer Overflow (BUFOVF), and Parity Error (PERR). Once an error happens, the corresponding error bit will be set until it is cleared by writing '1' to it. These bits are also cleared automatically when the receiver is disabled.

There are two methods for buffer overflow notification, selected by the Immediate Buffer Overflow Notification bit in the Control A register (CTRLA.IBON):

When CTRLA.IBON=1, STATUS.BUFOVF is raised immediately upon buffer overflow. Software can then empty the receive FIFO by reading RxDATA, until the receiver complete interrupt flag (INTFLAG.RXC) is cleared.

When CTRLA.IBON=0, the buffer overflow condition is attending data through the receive FIFO. After the received data is read, STATUS.BUFOVF will be set along with INTFLAG.RXC.

## Asynchronous Data Reception

The USART includes a clock recovery and data recovery unit for handling asynchronous data reception.

The clock recovery logic can synchronize the incoming asynchronous serial frames at the RxD pin to the internally generated baud-rate clock.

The data recovery logic samples and applies a low-pass filter to each incoming bit, thereby improving the noise immunity of the receiver.

## Asynchronous Operational Range

The operational range of the asynchronous reception depends on the accuracy of the internal baud-rate clock, the rate of the incoming frames, and the frame size (in number of bits). In addition, the operational range of the receiver is depending on the difference between the received bit rate and the internally generated baud rate. If the baud rate of an external transmitter is too high or too low compared to the internally generated baud rate, the receiver will not be able to synchronize the frames to the start bit.

There are two possible sources for a mismatch in baud rate: First, the reference clock will always have some minor instability. Second, the baud-rate generator cannot always do an exact division of the reference clock frequency to get the baud rate desired. In this case, the BAUD register value should be set to give the lowest possible error. Refer to *Clock Generation – Baud-Rate Generator* for details.

Recommended maximum receiver baud-rate errors for various character sizes are shown in the table below.

**Table 32-3. Asynchronous Receiver Error for 16-fold Oversampling**

D (Data bits+Parity)	R <sub>SLOW</sub> [%]	R <sub>FAST</sub> [%]	Max. total error [%]	Recommended max. Rx error [%]
5	94.12	107.69	+5.88/-7.69	±2.5
6	94.92	106.67	+5.08/-6.67	±2.0
7	95.52	105.88	+4.48/-5.88	±2.0
8	96.00	105.26	+4.00/-5.26	±2.0
9	96.39	104.76	+3.61/-4.76	±1.5
10	96.70	104.35	+3.30/-4.35	±1.5

The following equations calculate the ratio of the incoming data rate and internal receiver baud rate:

$$R_{\text{SLOW}} = \frac{(D + 1)S}{S - 1 + D \cdot S + S_F} \quad , \quad R_{\text{FAST}} = \frac{(D + 2)S}{(D + 1)S + S_M}$$

- $R_{\text{SLOW}}$  is the ratio of the slowest incoming data rate that can be accepted in relation to the receiver baud rate
- $R_{\text{FAST}}$  is the ratio of the fastest incoming data rate that can be accepted in relation to the receiver baud rate
- $D$  is the sum of character size and parity size ( $D = 5$  to  $10$  bits)
- $S$  is the number of samples per bit ( $S = 16, 8$  or  $3$ )
- $S_F$  is the first sample number used for majority voting ( $S_F = 7, 3,$  or  $2$ ) when CTRLA.SAMPA=0.
- $S_M$  is the middle sample number used for majority voting ( $S_M = 8, 4,$  or  $2$ ) when CTRLA.SAMPA=0.

The recommended maximum Rx Error assumes that the receiver and transmitter equally divide the maximum total error. Its connection to the SERCOM Receiver error acceptance is depicted in this figure:

**Figure 32-5. USART Rx Error Calculation**



The recommendation values in the table above accommodate errors of the clock source and the baud generator. The following figure gives an example for a baud rate of 3Mbps:

**Figure 32-6. USART Rx Error Calculation Example**



\*Transmitter Error depends on the external transmitter used in the application. It is advised that it is within the Recommended max. Rx Error (+/-1.5% in this example). Larger Transmitter Errors are acceptable but must lie within the Accepted Receiver Error.

## Related Links

[Clock Generation – Baud-Rate Generator](#)

[Asynchronous Arithmetic Mode BAUD Value Selection](#)

## 32.6.3 Additional Features

### 32.6.3.1 Parity

Even or odd parity can be selected for error checking by writing 0x1 to the Frame Format bit field in the Control A register (CTRLA.FORM).



If *even parity* is selected (CTRLB.PMODE=0), the parity bit of an outgoing frame is '1' if the data contains an odd number of bits that are '1', making the total number of '1' even.

If *odd parity* is selected (CTRLB.PMODE=1), the parity bit of an outgoing frame is '1' if the data contains an even number of bits that are '0', making the total number of '1' odd.

When parity checking is enabled, the parity checker calculates the parity of the data bits in incoming frames and compares the result with the parity bit of the corresponding frame. If a parity error is detected, the Parity Error bit in the Status register (STATUS.PERR) is set.

### 32.6.3.2 Hardware Handshaking

The USART features an out-of-band hardware handshaking flow control mechanism, implemented by connecting the RTS and CTS pins with the remote device, as shown in the figure below.

**Figure 32-7. Connection with a Remote Device for Hardware Handshaking**



Hardware handshaking is only available in the following configuration:

- USART with internal clock (CTRLA.MODE=1),
- Asynchronous mode (CTRLA.CMODE=0),
- and Flow control pinout (CTRLA.TXPO=2).

When the receiver is disabled or the receive FIFO is full, the receiver will drive the RTS pin high. This notifies the remote device to stop transfer after the ongoing transmission. Enabling and disabling the receiver by writing to CTRLB.RXEN will set/clear the RTS pin after a synchronization delay. When the receive FIFO goes full, RTS will be set immediately and the frame being received will be stored in the shift register until the receive FIFO is no longer full.

**Figure 32-8. Receiver Behavior when Operating with Hardware Handshaking**

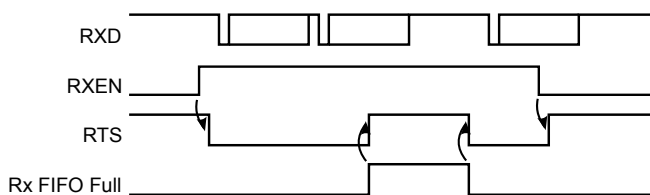

The current CTS Status is in the STATUS register (STATUS.CTS). Character transmission will start only if STATUS.CTS=0. When CTS is set, the transmitter will complete the ongoing transmission and stop transmitting.

**Figure 32-9. Transmitter Behavior when Operating with Hardware Handshaking**



### 32.6.3.3 IrDA Modulation and Demodulation

Transmission and reception can be encoded IrDA compliant up to 115.2 kb/s. IrDA modulation and demodulation work in the following configuration:

- IrDA encoding enabled (CTRLB.ENC=1),
- Asynchronous mode (CTRLA.CMODE=0),

- and 16x sample rate (CTRLA.SAMPR[0]=0).

During transmission, each low bit is transmitted as a high pulse. The pulse width is 3/16 of the baud rate period, as illustrated in the figure below.

**Figure 32-10. IrDA Transmit Encoding**



The reception decoder has two main functions.

The first is to synchronize the incoming data to the IrDA baud rate counter. Synchronization is performed at the start of each zero pulse.

The second main function is to decode incoming Rx data. If a pulse width meets the minimum length set by configuration (RXPL.RXPL), it is accepted. When the baud rate counter reaches its middle value (1/2 bit length), it is transferred to the receiver.

**Note:** Note that the polarity of the transmitter and receiver are opposite: During transmission, a '0' bit is transmitted as a '1' pulse. During reception, an accepted '0' pulse is received as a '0' bit.

**Example:** The figure below illustrates reception where RXPL.RXPL is set to 19. This indicates that the pulse width should be at least 20 SE clock cycles. When using BAUD=0xE666 or 160 SE cycles per bit, this corresponds to 2/16 baud clock as minimum pulse width required. In this case the first bit is accepted as a '0', the second bit is a '1', and the third bit is also a '1'. A low pulse is rejected since it does not meet the minimum requirement of 2/16 baud clock.

**Figure 32-11. IrDA Receive Decoding**



### 32.6.3.4 Break Character Detection and Auto-Baud

Break character detection and auto-baud are available in this configuration:

- Auto-baud frame format (CTRLA.FORM = 0x04 or 0x05),
- Asynchronous mode (CTRLA.CMODE = 0),
- and 16x sample rate using fractional baud rate generation (CTRLA.SAMPR = 1).

The auto-baud follows the LIN format. All LIN Frames start with a Break Field followed by a Sync Field. The USART uses a break detection threshold of greater than 11 nominal bit times at the configured baud rate. At any time, if more than 11 consecutive dominant bits are detected on the bus, the USART detects a Break Field. When a Break Field has been detected, the Receive Break interrupt flag (INTFLAG.RXBRK) is set and the USART expects the Sync Field character to be 0x55. This field is used to update the actual baud rate in order to stay synchronized. If the received Sync character is not 0x55, then the Inconsistent Sync Field error flag (STATUS.ISF) is set along with the Error interrupt flag (INTFLAG.ERROR), and the baud rate is unchanged.

Figure 32-12. LIN Break and Sync Fields

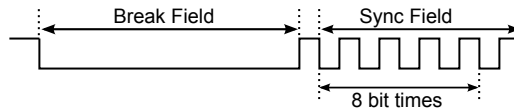

After a break field is detected and the start bit of the Sync Field is detected, a counter is started. The counter is then incremented for the next 8 bit times of the Sync Field. At the end of these 8 bit times, the counter is stopped. At this moment, the 13 most significant bits of the counter (value divided by 8) give the new clock divider (BAUD.BAUD), and the 3 least significant bits of this value (the remainder) give the new Fractional Part (BAUD.FP).

When the Sync Field has been received, the clock divider (BAUD.BAUD) and the Fractional Part (BAUD.FP) are updated after a synchronization delay. After the Break and Sync Fields are received, multiple characters of data can be received.

32.6.3.5 LIN Master

LIN master is available with the following configuration:

- LIN master format (CTRLA.FORM = 0x02)
- Asynchronous mode (CTRLA.CMODE = 0)
- 16x sample rate using fractional baud rate generation (CTRLA.SAMPR = 1)

LIN frames start with a header transmitted by the master. The header consists of the break, sync, and identifier fields. After the master transmits the header, the addressed slave will respond with 1-8 bytes of data plus checksum.

Figure 32-13. LIN Frame Format



Using the LIN command field (CTRLB.LINCMD), the complete header can be automatically transmitted, or software can control transmission of the various header components.

When CTRLB.LINCMD=0x1, software controls transmission of the LIN header. In this case, software uses the following sequence.

- CTRLB.LINCMD is written to 0x1.
- DATA register written to 0x00. This triggers transmission of the break field by hardware. Note that writing the DATA register with any other value will also result in the transmission of the break field by hardware.
- DATA register written to 0x55. The 0x55 value (sync) is transmitted.
- DATA register written to the identifier. The identifier is transmitted.

When CTRLB.LINCMD=0x2, hardware controls transmission of the LIN header. In this case, software uses the following sequence.

- CTRLB.LINCMD is written to 0x2.
- DATA register written to the identifier. This triggers transmission of the complete header by hardware. First the break field is transmitted. Next, the sync field is transmitted, and finally the identifier is transmitted.

In LIN master mode, the length of the break field is programmable using the break length field (CTRLC.BRKLLEN). When the LIN header command is used (CTRLB.LINCMD=0x2), the delay between the break and sync fields, in addition to the delay between the sync and ID fields are configurable using

the header delay field (CTRLC.HDRDLY). When manual transmission is used (CTRLB.LINCMD=0x1), software controls the delay between break and sync.

**Figure 32-14. LIN Header Generation**



After header transmission is complete, the slave responds with 1-8 data bytes plus checksum.

### 32.6.3.6 RS485

RS485 is available with the following configuration:

- USART frame format (CTRLA.FORM = 0x00 or 0x01)
- RS485 pinout (CTRLA.TXPO=0x3).

The RS485 feature enables control of an external line driver as shown in the figure below. While operating in RS485 mode, the transmit enable pin (TE) is driven high when the transmitter is active.

**Figure 32-15. RS485 Bus Connection**



The TE pin will remain high for the complete frame including stop bit(s). If a Guard Time is programmed in the Control C register (CTRLC.GTIME), the line will remain driven after the last character completion. The following figure shows a transfer with one stop bit and CTRLC.GTIME=3.

**Figure 32-16. Example of TE Drive with Guard Time**



The Transmit Complete interrupt flag (INTFLAG.TXC) will be raised after the guard time is complete and TE goes low.

### 32.6.3.7 Collision Detection

When the receiver and transmitter are connected either through pin configuration or externally, transmit collision can be detected after selecting the Collision Detection Enable bit in the CTRLB register (CTRLB.COLDEN=1). To detect collision, the receiver and transmitter must be enabled (CTRLB.RXEN=1 and CTRLB.TXEN=1).

Collision detection is performed for each bit transmitted by comparing the received value with the transmit value, as shown in the figure below. While the transmitter is idle (no transmission in progress), characters can be received on RxD without triggering a collision.

**Figure 32-17. Collision Checking**



The next figure shows the conditions for a collision detection. In this case, the start bit and the first data bit are received with the same value as transmitted. The second received data bit is found to be different than the transmitted bit at the detection point, which indicates a collision.

**Figure 32-18. Collision Detected**



When a collision is detected, the USART follows this sequence:

1. Abort the current transfer.
2. Flush the transmit buffer.
3. Disable transmitter (CTRLB.TXEN=0)
  - This is done after a synchronization delay. The CTRLB Synchronization Busy bit (SYNCBUSY.CTRLB) will be set until this is complete.
  - After disabling, the TxD pin will be tri-stated.
4. Set the Collision Detected bit (STATUS.COLL) along with the Error interrupt flag (INTFLAG.ERROR).
5. Set the Transmit Complete interrupt flag (INTFLAG.TXC), since the transmit buffer no longer contains data.

After a collision, software must manually enable the transmitter again before continuing, after assuring that the CTRLB Synchronization Busy bit (SYNCBUSY.CTRLB) is not set.

### 32.6.3.8 Loop-Back Mode

For loop-back mode, configure the Receive Data Pinout (CTRLA.RXPO) and Transmit Data Pinout (CTRLA.TXPO) to use the same data pins for transmit and receive. The loop-back is through the pad, so the signal is also available externally.

### 32.6.3.9 Start-of-Frame Detection

The USART start-of-frame detector can wake up the CPU when it detects a start bit. In standby sleep mode, the internal fast startup oscillator must be selected as the GCLK\_SERCOMx\_CORE source.

When a 1-to-0 transition is detected on RxD, the 8MHz Internal Oscillator is powered up and the USART clock is enabled. After startup, the rest of the data frame can be received, provided that the baud rate is slow enough in relation to the fast startup internal oscillator start-up time. Refer to *Electrical Characteristics* for details. The start-up time of this oscillator varies with supply voltage and temperature.

The USART start-of-frame detection works both in asynchronous and synchronous modes. It is enabled by writing '1' to the Start of Frame Detection Enable bit in the Control B register (CTRLB.SFDE).

If the Receive Start Interrupt Enable bit in the Interrupt Enable Set register (INTENSET.RXS) is set, the Receive Start interrupt is generated immediately when a start is detected.

When using start-of-frame detection without the Receive Start interrupt, start detection will force the 8MHz Internal Oscillator and USART clock active while the frame is being received. In this case, the CPU will not wake up until the Receive Complete interrupt is generated.

### Related Links

[Electrical Characteristics 85°C \(SAM C20J/G/E\)](#)

### 32.6.3.10 Sample Adjustment

In asynchronous mode (CTRLA.CMODE=0), three samples in the middle are used to determine the value based on majority voting. The three samples used for voting can be selected using the Sample Adjustment bit field in Control A register (CTRLA.SAMPA). When CTRLA.SAMPA=0, samples 7-8-9 are used for 16x oversampling, and samples 3-4-5 are used for 8x oversampling.

### 32.6.4 DMA, Interrupts and Events

**Table 32-4. Module Request for SERCOM USART**

Condition	Request		
	DMA	Interrupt	Event
Data Register Empty (DRE)	Yes (request cleared when data is written)	Yes	NA
Receive Complete (RXC)	Yes (request cleared when data is read)	Yes	
Transmit Complete (TXC)	NA	Yes	
Receive Start (RXS)	NA	Yes	
Clear to Send Input Change (CTSIC)	NA	Yes	
Receive Break (RXBRK)	NA	Yes	
Error (ERROR)	NA	Yes	

#### 32.6.4.1 DMA Operation

The USART generates the following DMA requests:

- Data received (RX): The request is set when data is available in the receive FIFO. The request is cleared when DATA is read.
- Data transmit (TX): The request is set when the transmit buffer (TX DATA) is empty. The request is cleared when DATA is written.

#### 32.6.4.2 Interrupts

The USART has the following interrupt sources. These are asynchronous interrupts, and can wake up the device from any sleep mode:

- Data Register Empty (DRE)
- Receive Complete (RXC)
- Transmit Complete (TXC)
- Receive Start (RXS)
- Clear to Send Input Change (CTSIC)

- Received Break (RXBRK)
- Error (ERROR)

Each interrupt source has its own interrupt flag. The interrupt flag in the Interrupt Flag Status and Clear register (INTFLAG) will be set when the interrupt condition is met. Each interrupt can be individually enabled by writing '1' to the corresponding bit in the Interrupt Enable Set register (INTENSET), and disabled by writing '1' to the corresponding bit in the Interrupt Enable Clear register (INTENCLR).

An interrupt request is generated when the interrupt flag is set and if the corresponding interrupt is enabled. The interrupt request remains active until either the interrupt flag is cleared, the interrupt is disabled, or the USART is reset. For details on clearing interrupt flags, refer to the INTFLAG register description.

The USART has one common interrupt request line for all the interrupt sources. The value of INTFLAG indicates which interrupt is executed. Note that interrupts must be globally enabled for interrupt requests. Refer to *Nested Vector Interrupt Controller* for details.

#### Related Links

[Nested Vector Interrupt Controller](#)

#### 32.6.4.3 Events

Not applicable.

#### 32.6.5 Sleep Mode Operation

The behavior in sleep mode is depending on the clock source and the Run In Standby bit in the Control A register (CTRLA.RUNSTDBY):

- Internal clocking, CTRLA.RUNSTDBY=1: GCLK\_SERCOMx\_CORE can be enabled in all sleep modes. Any interrupt can wake up the device.
- External clocking, CTRLA.RUNSTDBY=1: The Receive Start and the Receive Complete interrupt(s) can wake up the device.
- Internal clocking, CTRLA.RUNSTDBY=0: Internal clock will be disabled, after any ongoing transfer was completed. The Receive Start and the Receive Complete interrupt(s) can wake up the device.
- External clocking, CTRLA.RUNSTDBY=0: External clock will be disconnected, after any ongoing transfer was completed. All reception will be dropped.

#### 32.6.6 Synchronization

Due to asynchronicity between the main clock domain and the peripheral clock domains, some registers need to be synchronized when written or read.

The following bits are synchronized when written:

- Software Reset bit in the CTRLA register (CTRLA.SWRST)
- Enable bit in the CTRLA register (CTRLA.ENABLE)
- Receiver Enable bit in the CTRLB register (CTRLB.RXEN)
- Transmitter Enable bit in the Control B register (CTRLB.TXEN)

**Note:** CTRLB.RXEN is write-synchronized somewhat differently. See also [CTRLB](#) for details.

Required write-synchronization is denoted by the "Write-Synchronized" property in the register description.

#### Related Links

[Register Synchronization](#)

## 32.7 Register Summary

Offset	Name	Bit Pos.									
0x00	CTRLA	7:0	RUNSTDBY			MODE[2:0]		ENABLE	SWRST		
0x01		15:8	SAMPR[2:0]						IBON		
0x02		23:16	SAMP[1:0]		RXPO[1:0]				TXPO[1:0]		
0x03		31:24		DORD	CPOL	CMODE	FORM[3:0]				
0x04	CTRLB	7:0		SBMODE				CHSIZE[2:0]			
0x05		15:8			PMODE		ENC	SFDE	COLDEN		
0x06		23:16						RXEN	TXEN		
0x07		31:24							LINCMD[1:0]		
0x08	CTRLC	7:0						GTIME[2:0]			
0x09		15:8				HDRDLY[1:0]		BRKLEN[1:0]			
0x0A		23:16									
0x0B		31:24									
0x0C	BAUD	7:0	BAUD[7:0]								
0x0D		15:8	BAUD[15:8]								
0x0E	RXPL	7:0	RXPL[7:0]								
0x0F	Reserved										
0x13											
0x14	INTENCLR	7:0	ERROR		RXBRK	CTSIC	RXS	RXC	TXC	DRE	
0x15	Reserved										
0x16	INTENSET	7:0	ERROR		RXBRK	CTSIC	RXS	RXC	TXC	DRE	
0x17	Reserved										
0x18	INTFLAG	7:0	ERROR		RXBRK	CTSIC	RXS	RXC	TXC	DRE	
0x19	Reserved										
0x1A	STATUS	7:0		TXE	COLL	ISF	CTS	BUFOVF	FERR	PERR	
0x1B		15:8									
0x1C	SYNDBUSY	7:0						CTRLB	ENABLE	SWRST	
0x1D		15:8									
0x1E		23:16									
0x1F		31:24									
0x20	Reserved										
0x27											
0x28	DATA	7:0	DATA[7:0]								
0x29		15:8								DATA[8:8]	
0x2A	Reserved										
0x2F											
0x30		DBGCTRL	7:0								DBGSTOP

## 32.8 Register Description

Registers can be 8, 16, or 32 bits wide. Atomic 8-, 16-, and 32-bit accesses are supported. In addition, the 8-bit quarters and 16-bit halves of a 32-bit register, and the 8-bit halves of a 16-bit register can be accessed directly.



Some registers require synchronization when read and/or written. Synchronization is denoted by the "Read-Synchronized" and/or "Write-Synchronized" property in each individual register description.

Optional write-protection by the Peripheral Access Controller (PAC) is denoted by the "PAC Write-Protection" property in each individual register description.

Some registers are enable-protected, meaning they can only be written when the module is disabled. Enable-protection is denoted by the "Enable-Protected" property in each individual register description.

## 32.8.1 Control A

**Name:** CTRLA

**Offset:** 0x00 [ID-00000fa7]

**Reset:** 0x00000000

**Property:** PAC Write-Protection, Enable-Protected, Write-Synchronized

	Bit	31	30	29	28	27	26	25	24
			DORD	CPOL	CMODE	FORM[3:0]			
Access			R/W	R/W	R/W	R/W	R/W	R/W	R/W
Reset			0	0	0	0	0	0	0
	Bit	23	22	21	20	19	18	17	16
		SAMPA[1:0]		RXPO[1:0]				TXPO[1:0]	
Access		R/W	R/W	R/W	R/W			R/W	R/W
Reset		0	0	0	0			0	0
	Bit	15	14	13	12	11	10	9	8
		SAMPR[2:0]							IBON
Access		R/W	R/W	R/W					R
Reset		0	0	0					0
	Bit	7	6	5	4	3	2	1	0
		RUNSTDBY			MODE[2:0]		ENABLE	SWRST	
Access		R/W			R/W	R/W	R/W	R/W	R/W
Reset		0			0	0	0	0	0

### Bit 30 – DORD: Data Order

This bit selects the data order when a character is shifted out from the Data register.

This bit is not synchronized.

Value	Description
0	MSB is transmitted first.
1	LSB is transmitted first.

### Bit 29 – CPOL: Clock Polarity

This bit selects the relationship between data output change and data input sampling in synchronous mode.

This bit is not synchronized.

CPOL	TxD Change	RxD Sample
0x0	Rising XCK edge	Falling XCK edge
0x1	Falling XCK edge	Rising XCK edge

### Bit 28 – CMODE: Communication Mode

This bit selects asynchronous or synchronous communication.

This bit is not synchronized.

Value	Description
0	Asynchronous communication.
1	Synchronous communication.

### Bits 27:24 – FORM[3:0]: Frame Format

These bits define the frame format.

These bits are not synchronized.

FORM[3:0]	Description
0x0	USART frame
0x1	USART frame with parity
0x2	LIN Master - Break and sync generation. See LIN Command (CTRLB.LINCMD).
0x3	Reserved
0x4	Auto-baud (LIN Slave) - break detection and auto-baud.
0x5	Auto-baud - break detection and auto-baud with parity
0x6-0xF	Reserved

### Bits 23:22 – SAMPA[1:0]: Sample Adjustment

These bits define the sample adjustment.

These bits are not synchronized.

SAMPA[1:0]	16x Over-sampling (CTRLA.SAMPR=0 or 1)	8x Over-sampling (CTRLA.SAMPR=2 or 3)
0x0	7-8-9	3-4-5
0x1	9-10-11	4-5-6
0x2	11-12-13	5-6-7
0x3	13-14-15	6-7-8

### Bits 21:20 – RXPO[1:0]: Receive Data Pinout

These bits define the receive data (RxD) pin configuration.

These bits are not synchronized.

RXPO[1:0]	Name	Description
0x0	PAD[0]	SERCOM PAD[0] is used for data reception
0x1	PAD[1]	SERCOM PAD[1] is used for data reception
0x2	PAD[2]	SERCOM PAD[2] is used for data reception
0x3	PAD[3]	SERCOM PAD[3] is used for data reception

### Bits 17:16 – TXPO[1:0]: Transmit Data Pinout

These bits define the transmit data (TxD) and XCK pin configurations.

This bit is not synchronized.

TXPO	TxD Pin Location	XCK Pin Location (When Applicable)	RTS/TE	CTS
0x0	SERCOM PAD[0]	SERCOM PAD[1]	N/A	N/A
0x1	SERCOM PAD[2]	SERCOM PAD[3]	N/A	N/A
0x2	SERCOM PAD[0]	N/A	SERCOM PAD[2]	SERCOM PAD[3]
0x3	SERCOM_PAD[0]	SERCOM_PAD[1]	SERCOM_PAD[2]	N/A

### Bits 15:13 – SAMPR[2:0]: Sample Rate

These bits select the sample rate.

These bits are not synchronized.

SAMPR[2:0]	Description
0x0	16x over-sampling using arithmetic baud rate generation.
0x1	16x over-sampling using fractional baud rate generation.
0x2	8x over-sampling using arithmetic baud rate generation.
0x3	8x over-sampling using fractional baud rate generation.
0x4	3x over-sampling using arithmetic baud rate generation.
0x5-0x7	Reserved

### Bit 8 – IBON: Immediate Buffer Overflow Notification

This bit controls when the buffer overflow status bit (STATUS.BUFOVF) is asserted when a buffer overflow occurs.

Value	Description
0	STATUS.BUFOVF is asserted when it occurs in the data stream.
1	STATUS.BUFOVF is asserted immediately upon buffer overflow.

### Bit 7 – RUNSTDBY: Run In Standby

This bit defines the functionality in standby sleep mode.

This bit is not synchronized.

RUNSTDBY	External Clock	Internal Clock
0x0	External clock is disconnected when ongoing transfer is finished. All reception is dropped.	Generic clock is disabled when ongoing transfer is finished. The device can wake up on Receive Start or Transfer Complete interrupt.
0x1	Wake on Receive Start or Receive Complete interrupt.	Generic clock is enabled in all sleep modes. Any interrupt can wake up the device.

### Bits 4:2 – MODE[2:0]: Operating Mode

These bits select the USART serial communication interface of the SERCOM.

These bits are not synchronized.

Value	Description
0x0	USART with external clock
0x1	USART with internal clock

### Bit 1 – ENABLE: Enable

Due to synchronization, there is delay from writing CTRLA.ENABLE until the peripheral is enabled/disabled. The value written to CTRLA.ENABLE will read back immediately and the Enable Synchronization Busy bit in the Synchronization Busy register (SYNCBUSY.ENABLE) will be set. SYNCBUSY.ENABLE is cleared when the operation is complete.

This bit is not enable-protected.

Value	Description
0	The peripheral is disabled or being disabled.
1	The peripheral is enabled or being enabled.

### Bit 0 – SWRST: Software Reset

Writing '0' to this bit has no effect.

Writing '1' to this bit resets all registers in the SERCOM, except DBGCTRL, to their initial state, and the SERCOM will be disabled.

Writing '1' to CTRLA.SWRST will always take precedence, meaning that all other writes in the same write-operation will be discarded. Any register write access during the ongoing reset will result in an APB error. Reading any register will return the reset value of the register.

Due to synchronization, there is a delay from writing CTRLA.SWRST until the reset is complete. CTRLA.SWRST and SYNCBUSY.SWRST will both be cleared when the reset is complete.

This bit is not enable-protected.

Value	Description
0	There is no reset operation ongoing.
1	The reset operation is ongoing.

## 32.8.2 Control B

**Name:** CTRLB  
**Offset:** 0x04 [ID-0000fa7]  
**Reset:** 0x00000000  
**Property:** PAC Write-Protection, Enable-Protected, Write-Synchronized

Bit	31	30	29	28	27	26	25	24
							LINCMD[1:0]	
Access							R/W	R/W
Reset							0	0
Bit	23	22	21	20	19	18	17	16
							RXEN	TXEN
Access							R/W	R/W
Reset							0	0
Bit	15	14	13	12	11	10	9	8
			PMODE			ENC	SFDE	COLDEN
Access			R/W			R/W	R/W	R/W
Reset			0			0	0	0
Bit	7	6	5	4	3	2	1	0
			SBMODE			CHSIZE[2:0]		
Access			R/W			R/W	R/W	R/W
Reset			0			0	0	0

**Bits 25:24 – LINCMD[1:0]: LIN Command**

These bits define the LIN header transmission control. This field is only valid in LIN master mode (CTRLA.FORM= LIN Master).

These are strobe bits and will always read back as zero.

These bits are not enable-protected.

Value	Description
0x0	Normal USART transmission.
0x1	Break field is transmitted when DATA is written.
0x2	Break, sync and identifier are automatically transmitted when DATA is written with the identifier.
0x3	Reserved

**Bit 17 – RXEN: Receiver Enable**

Writing '0' to this bit will disable the USART receiver. Disabling the receiver will flush the receive buffer and clear the FERR, PERR and BUFOVF bits in the STATUS register.

Writing '1' to CTRLB.RXEN when the USART is disabled will set CTRLB.RXEN immediately. When the USART is enabled, CTRLB.RXEN will be cleared, and SYNCBUSY.CTRLB will be set and remain set until the receiver is enabled. When the receiver is enabled, CTRLB.RXEN will read back as '1'.

Writing '1' to CTRLB.RXEN when the USART is enabled will set SYNCBUSY.CTRLB, which will remain set until the receiver is enabled, and CTRLB.RXEN will read back as '1'.

This bit is not enable-protected.

Value	Description
0	The receiver is disabled or being enabled.
1	The receiver is enabled or will be enabled when the USART is enabled.

### Bit 16 – TXEN: Transmitter Enable

Writing '0' to this bit will disable the USART transmitter. Disabling the transmitter will not become effective until ongoing and pending transmissions are completed.

Writing '1' to CTRLB.TXEN when the USART is disabled will set CTRLB.TXEN immediately. When the USART is enabled, CTRLB.TXEN will be cleared, and SYNCBUSY.CTRLB will be set and remain set until the transmitter is enabled. When the transmitter is enabled, CTRLB.TXEN will read back as '1'.

Writing '1' to CTRLB.TXEN when the USART is enabled will set SYNCBUSY.CTRLB, which will remain set until the receiver is enabled, and CTRLB.TXEN will read back as '1'.

This bit is not enable-protected.

Value	Description
0	The transmitter is disabled or being enabled.
1	The transmitter is enabled or will be enabled when the USART is enabled.

### Bit 13 – PMODE: Parity Mode

This bit selects the type of parity used when parity is enabled (CTRLA.FORM is '1'). The transmitter will automatically generate and send the parity of the transmitted data bits within each frame. The receiver will generate a parity value for the incoming data and parity bit, compare it to the parity mode and, if a mismatch is detected, STATUS.PERR will be set.

This bit is not synchronized.

Value	Description
0	Even parity.
1	Odd parity.

### Bit 10 – ENC: Encoding Format

This bit selects the data encoding format.

This bit is not synchronized.

Value	Description
0	Data is not encoded.
1	Data is IrDA encoded.

### Bit 9 – SFDE: Start of Frame Detection Enable

This bit controls whether the start-of-frame detector will wake up the device when a start bit is detected on the RxD line.

This bit is not synchronized.

SFDE	INTENSET.RXS	INTENSET.RXC	Description
0	X	X	Start-of-frame detection disabled.
1	0	0	Reserved
1	0	1	Start-of-frame detection enabled. RXC wakes up the device from all sleep modes.

SFDE	INTENSET.RXS	INTENSET.RXC	Description
1	1	0	Start-of-frame detection enabled. RXS wakes up the device from all sleep modes.
1	1	1	Start-of-frame detection enabled. Both RXC and RXS wake up the device from all sleep modes.

**Bit 8 – COLDEN: Collision Detection Enable**

This bit enables collision detection.

This bit is not synchronized.

Value	Description
0	Collision detection is not enabled.
1	Collision detection is enabled.

**Bit 6 – SBMODE: Stop Bit Mode**

This bit selects the number of stop bits transmitted.

This bit is not synchronized.

Value	Description
0	One stop bit.
1	Two stop bits.

**Bits 2:0 – CHSIZE[2:0]: Character Size**

These bits select the number of bits in a character.

These bits are not synchronized.

CHSIZE[2:0]	Description
0x0	8 bits
0x1	9 bits
0x2-0x4	Reserved
0x5	5 bits
0x6	6 bits
0x7	7 bits

### 32.8.3 Control C

**Name:** CTRLC

**Offset:** 0x08 [ID-00000fa7]

**Reset:** 0x00000000

**Property:** PAC Write-Protection, Enable-Protected

Bit	31	30	29	28	27	26	25	24	
Access									
Reset									
Bit	23	22	21	20	19	18	17	16	
Access									
Reset									
Bit	15	14	13	12	11	10	9	8	
					HDRDLY[1:0]		BRKLEN[1:0]		
Access					R/W	R/W	R/W	R/W	
Reset					0	0	0	0	
Bit	7	6	5	4	3	2	1	0	
						GTIME[2:0]			
Access						R/W	R/W	R/W	
Reset						0	0	0	

**Bits 11:10 – HDRDLY[1:0]: LIN Master Header Delay**

These bits define the delay between break and sync transmission in addition to the delay between the sync and identifier (ID) fields when in LIN master mode (CTRLA.FORM=0x2). This field is only valid when using the LIN header command (CTRLB.LINCMD=0x2).

Value	Description
0x0	Delay between break and sync transmission is 1 bit time. Delay between sync and ID transmission is 1 bit time.
0x1	Delay between break and sync transmission is 4 bit time. Delay between sync and ID transmission is 4 bit time.
0x2	Delay between break and sync transmission is 8 bit time. Delay between sync and ID transmission is 4 bit time.
0x3	Delay between break and sync transmission is 14 bit time. Delay between sync and ID transmission is 4 bit time.

**Bits 9:8 – BRKLEN[1:0]: LIN Master Break Length**

These bits define the length of the break field transmitted when in LIN master mode (CTRLA.FORM=0x2).

Value	Description
0x0	Break field transmission is 13 bit times
0x1	Break field transmission is 17 bit times
0x2	Break field transmission is 21 bit times
0x3	Break field transmission is 26 bit times

**Bits 2:0 – GTIME[2:0]: Guard Time**

These bits define the guard time when using RS485 mode (CTRLA.TXPO=0x3).



For RS485 mode, the guard time is programmable from 0-7 bit times and defines the time that the transmit enable pin (TE) remains high after the last stop bit is transmitted and there is no remaining data to be transmitted.

## 32.8.4 Baud

**Name:** BAUD  
**Offset:** 0x0C [ID-00000fa7]  
**Reset:** 0x0000  
**Property:** Enable-Protected, PAC Write-Protection

Bit	15	14	13	12	11	10	9	8
	BAUD[15:8]							
Access	R/W	R/W	R/W	R/W	R/W	R/W	R/W	R/W
Reset	0	0	0	0	0	0	0	0
Bit	7	6	5	4	3	2	1	0
	BAUD[7:0]							
Access	R/W	R/W	R/W	R/W	R/W	R/W	R/W	R/W
Reset	0	0	0	0	0	0	0	0

### Bits 15:0 – BAUD[15:0]: Baud Value

Arithmetic Baud Rate Generation (`CTRLA.SAMPR[0]=0`):

These bits control the clock generation, as described in the *SERCOM Baud Rate* section.

If Fractional Baud Rate Generation (`CTRLA.SAMPR[0]=1`) bit positions 15 to 13 are replaced by `FP[2:0]` Fractional Part:

- **Bits 15:13 - FP[2:0]: Fractional Part**

These bits control the clock generation, as described in the *SERCOM Clock Generation – Baud-Rate Generator* section.

- **Bits 12:0 - BAUD[21:0]: Baud Value**

These bits control the clock generation, as described in the *SERCOM Clock Generation – Baud-Rate Generator* section.

## 32.8.5 Receive Pulse Length Register

**Name:** RXPL  
**Offset:** 0x0E [ID-00000fa7]  
**Reset:** 0x00  
**Property:** PAC Write-Protection

Bit	7	6	5	4	3	2	1	0
	RXPL[7:0]							
Access	R/W	R/W	R/W	R/W	R/W	R/W	R/W	R/W
Reset	0	0	0	0	0	0	0	0

**Bits 7:0 – RXPL[7:0]: Receive Pulse Length**

When the encoding format is set to IrDA (CTRLB.ENC=1), these bits control the minimum pulse length that is required for a pulse to be accepted by the IrDA receiver with regards to the serial engine clock period  $SE_{per}$ .

$$PULSE \geq (RXPL + 2) \cdot SE_{per}$$

**32.8.6 Interrupt Enable Clear**

This register allows the user to disable an interrupt without doing a read-modify-write operation. Changes in this register will also be reflected in the Interrupt Enable Set register (INTENSET).

**Name:** INTENCLR  
**Offset:** 0x14 [ID-00000fa7]  
**Reset:** 0x00  
**Property:** PAC Write-Protection

Bit	7	6	5	4	3	2	1	0
	ERROR		RXBRK	CTSIC	RXS	RXC	TXC	DRE
Access	R/W		R/W	R/W	R/W	R/W	R/W	R/W
Reset	0		0	0	0	0	0	0

**Bit 7 – ERROR: Error Interrupt Enable**

Writing '0' to this bit has no effect.

Writing '1' to this bit will clear the Error Interrupt Enable bit, which disables the Error interrupt.

Value	Description
0	Error interrupt is disabled.
1	Error interrupt is enabled.

**Bit 5 – RXBRK: Receive Break Interrupt Enable**

Writing '0' to this bit has no effect.

Writing '1' to this bit will clear the Receive Break Interrupt Enable bit, which disables the Receive Break interrupt.

Value	Description
0	Receive Break interrupt is disabled.
1	Receive Break interrupt is enabled.

**Bit 4 – CTSIC: Clear to Send Input Change Interrupt Enable**

Writing '0' to this bit has no effect.

Writing '1' to this bit will clear the Clear To Send Input Change Interrupt Enable bit, which disables the Clear To Send Input Change interrupt.

Value	Description
0	Clear To Send Input Change interrupt is disabled.
1	Clear To Send Input Change interrupt is enabled.

### Bit 3 – RXS: Receive Start Interrupt Enable

Writing '0' to this bit has no effect.

Writing '1' to this bit will clear the Receive Start Interrupt Enable bit, which disables the Receive Start interrupt.

Value	Description
0	Receive Start interrupt is disabled.
1	Receive Start interrupt is enabled.

### Bit 2 – RXC: Receive Complete Interrupt Enable

Writing '0' to this bit has no effect.

Writing '1' to this bit will clear the Receive Complete Interrupt Enable bit, which disables the Receive Complete interrupt.

Value	Description
0	Receive Complete interrupt is disabled.
1	Receive Complete interrupt is enabled.

### Bit 1 – TXC: Transmit Complete Interrupt Enable

Writing '0' to this bit has no effect.

Writing '1' to this bit will clear the Transmit Complete Interrupt Enable bit, which disables the Receive Complete interrupt.

Value	Description
0	Transmit Complete interrupt is disabled.
1	Transmit Complete interrupt is enabled.

### Bit 0 – DRE: Data Register Empty Interrupt Enable

Writing '0' to this bit has no effect.

Writing '1' to this bit will clear the Data Register Empty Interrupt Enable bit, which disables the Data Register Empty interrupt.

Value	Description
0	Data Register Empty interrupt is disabled.
1	Data Register Empty interrupt is enabled.

## 32.8.7 Interrupt Enable Set

This register allows the user to disable an interrupt without doing a read-modify-write operation. Changes in this register will also be reflected in the Interrupt Enable Clear register (INTENCLR).

**Name:** INTENSET

**Offset:** 0x16 [ID-00000fa7]

**Reset:** 0x00

**Property:** PAC Write-Protection

Bit	7	6	5	4	3	2	1	0
	ERROR		RXBRK	CTSIC	RXS	RXC	TXC	DRE
Access	R/W		R/W	R/W	R/W	R/W	R/W	R/W
Reset	0		0	0	0	0	0	0

### Bit 7 – ERROR: Error Interrupt Enable

Writing '0' to this bit has no effect.

Writing '1' to this bit will set the Error Interrupt Enable bit, which enables the Error interrupt.

Value	Description
0	Error interrupt is disabled.
1	Error interrupt is enabled.

### Bit 5 – RXBRK: Receive Break Interrupt Enable

Writing '0' to this bit has no effect.

Writing '1' to this bit will set the Receive Break Interrupt Enable bit, which enables the Receive Break interrupt.

Value	Description
0	Receive Break interrupt is disabled.
1	Receive Break interrupt is enabled.

### Bit 4 – CTSIC: Clear to Send Input Change Interrupt Enable

Writing '0' to this bit has no effect.

Writing '1' to this bit will set the Clear To Send Input Change Interrupt Enable bit, which enables the Clear To Send Input Change interrupt.

Value	Description
0	Clear To Send Input Change interrupt is disabled.
1	Clear To Send Input Change interrupt is enabled.

### Bit 3 – RXS: Receive Start Interrupt Enable

Writing '0' to this bit has no effect.

Writing '1' to this bit will set the Receive Start Interrupt Enable bit, which enables the Receive Start interrupt.

Value	Description
0	Receive Start interrupt is disabled.
1	Receive Start interrupt is enabled.

### Bit 2 – RXC: Receive Complete Interrupt Enable

Writing '0' to this bit has no effect.

Writing '1' to this bit will set the Receive Complete Interrupt Enable bit, which enables the Receive Complete interrupt.

Value	Description
0	Receive Complete interrupt is disabled.
1	Receive Complete interrupt is enabled.

### Bit 1 – TXC: Transmit Complete Interrupt Enable

Writing '0' to this bit has no effect.

Writing '1' to this bit will set the Transmit Complete Interrupt Enable bit, which enables the Transmit Complete interrupt.

Value	Description
0	Transmit Complete interrupt is disabled.
1	Transmit Complete interrupt is enabled.

### Bit 0 – DRE: Data Register Empty Interrupt Enable

Writing '0' to this bit has no effect.

Writing '1' to this bit will set the Data Register Empty Interrupt Enable bit, which enables the Data Register Empty interrupt.

Value	Description
0	Data Register Empty interrupt is disabled.
1	Data Register Empty interrupt is enabled.

## 32.8.8 Interrupt Flag Status and Clear

**Name:** INTFLAG

**Offset:** 0x18 [ID-00000fa7]

**Reset:** 0x00

**Property:** -

Bit	7	6	5	4	3	2	1	0
	ERROR		RXBRK	CTSIC	RXS	RXC	TXC	DRE
Access	R/W		R/W	R/W	R/W	R	R/W	R
Reset	0		0	0	0	0	0	0

### Bit 7 – ERROR: Error

This flag is cleared by writing '1' to it.

This bit is set when any error is detected. Errors that will set this flag have corresponding status flags in the STATUS register. Errors that will set this flag are COLL, ISF, BUFOVF, FERR, and PERR. Writing '0' to this bit has no effect.

Writing '1' to this bit will clear the flag.

### Bit 5 – RXBRK: Receive Break

This flag is cleared by writing '1' to it.

This flag is set when auto-baud is enabled (CTRLA.FORM) and a break character is received.

Writing '0' to this bit has no effect.

Writing '1' to this bit will clear the flag.

### Bit 4 – CTSIC: Clear to Send Input Change

This flag is cleared by writing a '1' to it.

This flag is set when a change is detected on the CTS pin.

Writing '0' to this bit has no effect.

Writing '1' to this bit will clear the flag.

### **Bit 3 – RXS: Receive Start**

This flag is cleared by writing '1' to it.

This flag is set when a start condition is detected on the RxD line and start-of-frame detection is enabled (CTRLB.SFDE is '1').

Writing '0' to this bit has no effect.

Writing '1' to this bit will clear the Receive Start interrupt flag.

### **Bit 2 – RXC: Receive Complete**

This flag is cleared by reading the Data register (DATA) or by disabling the receiver.

This flag is set when there are unread data in DATA.

Writing '0' to this bit has no effect.

Writing '1' to this bit has no effect.

### **Bit 1 – TXC: Transmit Complete**

This flag is cleared by writing '1' to it or by writing new data to DATA.

This flag is set when the entire frame in the transmit shift register has been shifted out and there are no new data in DATA.

Writing '0' to this bit has no effect.

Writing '1' to this bit will clear the flag.

### **Bit 0 – DRE: Data Register Empty**

This flag is cleared by writing new data to DATA.

This flag is set when DATA is empty and ready to be written.

Writing '0' to this bit has no effect.

Writing '1' to this bit has no effect.

## **32.8.9 Status**

**Name:** STATUS

**Offset:** 0x1A [ID-0000fa7]

**Reset:** 0x0000

**Property:** -

	Bit	15	14	13	12	11	10	9	8
Access									
Reset									
	Bit	7	6	5	4	3	2	1	0
			TXE	COLL	ISF	CTS	BUFOVF	FERR	PERR
Access			R/W	R/W	R/W	R	R/W	R/W	R/W
Reset			0	0	0	0	0	0	0

**Bit 6 – TXE: Transmitter Empty**

When CTRLA.FORM is set to LIN master mode, this bit is set when any ongoing transmission is complete and TxDATA is empty. When CTRLA.FORM is not set to LIN master mode, this bit will always read back as zero.

Writing '0' to this bit has no effect.

Writing '1' to this bit will clear it.

**Bit 5 – COLL: Collision Detected**

This bit is cleared by writing '1' to the bit or by disabling the receiver.

This bit is set when collision detection is enabled (CTRLB.COLDEN) and a collision is detected.

Writing '0' to this bit has no effect.

Writing '1' to this bit will clear it.

**Bit 4 – ISF: Inconsistent Sync Field**

This bit is cleared by writing '1' to the bit or by disabling the receiver.

This bit is set when the frame format is set to auto-baud (CTRLA.FORM) and a sync field not equal to 0x55 is received.

Writing '0' to this bit has no effect.

Writing '1' to this bit will clear it.

**Bit 3 – CTS: Clear to Send**

This bit indicates the current level of the CTS pin when flow control is enabled (CTRLA.TXPO).

Writing '0' to this bit has no effect.

Writing '1' to this bit has no effect.

**Bit 2 – BUFOVF: Buffer Overflow**

Reading this bit before reading the Data register will indicate the error status of the next character to be read.

This bit is cleared by writing '1' to the bit or by disabling the receiver.

This bit is set when a buffer overflow condition is detected. A buffer overflow occurs when the receive buffer is full, there is a new character waiting in the receive shift register and a new start bit is detected.

Writing '0' to this bit has no effect.

Writing '1' to this bit will clear it.

## **Bit 1 – FERR: Frame Error**

Reading this bit before reading the Data register will indicate the error status of the next character to be read.

This bit is cleared by writing '1' to the bit or by disabling the receiver.

This bit is set if the received character had a frame error, i.e., when the first stop bit is zero.

Writing '0' to this bit has no effect.

Writing '1' to this bit will clear it.

## **Bit 0 – PERR: Parity Error**

Reading this bit before reading the Data register will indicate the error status of the next character to be read.

This bit is cleared by writing '1' to the bit or by disabling the receiver.

This bit is set if parity checking is enabled (CTRLA.FORM is 0x1, 0x5) and a parity error is detected.

Writing '0' to this bit has no effect.

Writing '1' to this bit will clear it.

### **32.8.10 Synchronization Busy**

**Name:** SYNCBUSY

**Offset:** 0x1C [ID-0000fa7]

**Reset:** 0x00000000

**Property:** -



	Bit	31	30	29	28	27	26	25	24	
Access										
Reset										
	Bit	23	22	21	20	19	18	17	16	
Access										
Reset										
	Bit	15	14	13	12	11	10	9	8	
Access										
Reset										
	Bit	7	6	5	4	3	2	1	0	
							CTRLB	ENABLE	SWRST	
Access							R	R	R	
Reset							0	0	0	

### Bit 2 – CTRLB: CTRLB Synchronization Busy

Writing to the CTRLB register when the SERCOM is enabled requires synchronization. When writing to CTRLB the SYNCBUSY.CTRLB bit will be set until synchronization is complete. If CTRLB is written while SYNCBUSY.CTRLB is asserted, an APB error will be generated.

Value	Description
0	CTRLB synchronization is not busy.
1	CTRLB synchronization is busy.

### Bit 1 – ENABLE: SERCOM Enable Synchronization Busy

Enabling and disabling the SERCOM (CTRLA.ENABLE) requires synchronization. When written, the SYNCBUSY.ENABLE bit will be set until synchronization is complete.

Writes to any register (except for CTRLA.SWRST) while enable synchronization is on-going will be discarded and an APB error will be generated.

Value	Description
0	Enable synchronization is not busy.
1	Enable synchronization is busy.

### Bit 0 – SWRST: Software Reset Synchronization Busy

Resetting the SERCOM (CTRLA.SWRST) requires synchronization. When written, the SYNCBUSY.SWRST bit will be set until synchronization is complete.

Writes to any register while synchronization is on-going will be discarded and an APB error will be generated.

Value	Description
0	SWRST synchronization is not busy.
1	SWRST synchronization is busy.

## 32.8.11 Data

**Name:** DATA  
**Offset:** 0x28 [ID-00000fa7]  
**Reset:** 0x0000  
**Property:** -

Bit	15	14	13	12	11	10	9	8
	[Greyed out bits]							DATA[8:8]
Access								R/W
Reset								0
Bit	7	6	5	4	3	2	1	0
	DATA[7:0]							
Access	R/W	R/W	R/W	R/W	R/W	R/W	R/W	R/W
Reset	0	0	0	0	0	0	0	0

**Bits 8:0 – DATA[8:0]: Data**

Reading these bits will return the contents of the Receive Data register. The register should be read only when the Receive Complete Interrupt Flag bit in the Interrupt Flag Status and Clear register (INTFLAG.RXC) is set. The status bits in STATUS should be read before reading the DATA value in order to get any corresponding error.

Writing these bits will write the Transmit Data register. This register should be written only when the Data Register Empty Interrupt Flag bit in the Interrupt Flag Status and Clear register (INTFLAG.DRE) is set.

### 32.8.12 Debug Control

**Name:** DBGCTRL  
**Offset:** 0x30 [ID-00000fa7]  
**Reset:** 0x00  
**Property:** PAC Write-Protection

Bit	7	6	5	4	3	2	1	0
	[Greyed out bits]							DBGSTOP
Access								R/W
Reset								0

**Bit 0 – DBGSTOP: Debug Stop Mode**

This bit controls the baud-rate generator functionality when the CPU is halted by an external debugger.

Value	Description
0	The baud-rate generator continues normal operation when the CPU is halted by an external debugger.
1	The baud-rate generator is halted when the CPU is halted by an external debugger.

## 33. SERCOM SPI – SERCOM Serial Peripheral Interface

### 33.1 Overview

The serial peripheral interface (SPI) is one of the available modes in the Serial Communication Interface (SERCOM).

The SPI uses the SERCOM transmitter and receiver configured as shown in [Block Diagram](#). Each side, master and slave, depicts a separate SPI containing a shift register, a transmit buffer and two receive buffers. In addition, the SPI master uses the SERCOM baud-rate generator, while the SPI slave can use the SERCOM address match logic. Labels in capital letters are synchronous to CLK\_SERCOMx\_APB and accessible by the CPU, while labels in lowercase letters are synchronous to the SCK clock.

#### Related Links

[SERCOM – Serial Communication Interface](#)

### 33.2 Features

SERCOM SPI includes the following features:

- Full-duplex, four-wire interface (MISO, MOSI, SCK,  $\overline{SS}$ )
- Single-buffered transmitter, double-buffered receiver
- Supports all four SPI modes of operation
- Single data direction operation allows alternate function on MISO or MOSI pin
- Selectable LSB- or MSB-first data transfer
- Can be used with DMA
- Master operation:
  - Serial clock speed,  $f_{SCK}=1/t_{SCK}^{(1)}$
  - 8-bit clock generator
  - Hardware controlled  $\overline{SS}$
- Slave operation:
  - Serial clock speed,  $f_{SCK}=1/t_{SSCK}^{(1)}$
  - Optional 8-bit address match operation
  - Operation in all sleep modes
  - Wake on  $\overline{SS}$  transition

1. For  $t_{SCK}$  and  $t_{SSCK}$  values, refer to SPI Timing Characteristics.

#### Related Links

[SERCOM in SPI Mode Timing](#)

[SERCOM – Serial Communication Interface](#)

Features

### 33.3 Block Diagram

Figure 33-1. Full-Duplex SPI Master Slave Interconnection



### 33.4 Signal Description

Table 33-1. SERCOM SPI Signals

Signal Name	Type	Description
PAD[3:0]	Digital I/O	General SERCOM pins

One signal can be mapped to one of several pins.

#### Related Links

[I/O Multiplexing and Considerations](#)

### 33.5 Product Dependencies

In order to use this peripheral, other parts of the system must be configured correctly, as described below.

#### 33.5.1 I/O Lines

In order to use the SERCOM's I/O lines, the I/O pins must be configured using the IO Pin Controller (PORT).

When the SERCOM is configured for SPI operation, the SERCOM controls the direction and value of the I/O pins according to the table below. Both PORT control bits PINCFGn.PULLEN and PINCFGn.DRVSTR are still effective. If the receiver is disabled, the data input pin can be used for other purposes. In master mode, the slave select line ( $\overline{SS}$ ) is hardware controlled when the Master Slave Select Enable bit in the Control B register (CTRLB.MSSEN) is '1'.

Table 33-2. SPI Pin Configuration

Pin	Master SPI	Slave SPI
MOSI	Output	Input
MISO	Input	Output
SCK	Output	Input
$\overline{SS}$	Output (CTRLB.MSSEN=1)	Input

The combined configuration of PORT, the Data In Pinout and the Data Out Pinout bit groups in the Control A register (CTRLA.DIPO and CTRLA.DOPO) define the physical position of the SPI signals in the table above.

## Related Links

[PORT: IO Pin Controller](#)

### 33.5.2 Power Management

This peripheral can continue to operate in any sleep mode where its source clock is running. The interrupts can wake up the device from sleep modes.

## Related Links

[PM – Power Manager](#)

### 33.5.3 Clocks

The SERCOM bus clock (CLK\_SERCOMx\_APB) can be enabled and disabled in the Main Clock Controller. Refer to *Peripheral Clock Masking* for details and default status of this clock.

A generic clock (GCLK\_SERCOMx\_CORE) is required to clock the SPI. This clock must be configured and enabled in the Generic Clock Controller before using the SPI.

This generic clock is asynchronous to the bus clock (CLK\_SERCOMx\_APB). Therefore, writes to certain registers will require synchronization to the clock domains.

## Related Links

[GCLK - Generic Clock Controller](#)

[Peripheral Clock Masking](#)

[Synchronization](#)

### 33.5.4 DMA

The DMA request lines are connected to the DMA Controller (DMAC). In order to use DMA requests with this peripheral the DMAC must be configured first. Refer to *DMAC – Direct Memory Access Controller* for details.

## Related Links

[DMAC – Direct Memory Access Controller](#)

### 33.5.5 Interrupts

The interrupt request line is connected to the Interrupt Controller. In order to use interrupt requests of this peripheral, the Interrupt Controller (NVIC) must be configured first. Refer to *Nested Vector Interrupt Controller* for details.

## Related Links

[Nested Vector Interrupt Controller](#)

### 33.5.6 Events

Not applicable.

### 33.5.7 Debug Operation

When the CPU is halted in debug mode, this peripheral will continue normal operation. If the peripheral is configured to require periodical service by the CPU through interrupts or similar, improper operation or data loss may result during debugging. This peripheral can be forced to halt operation during debugging - refer to the Debug Control (DBGCTRL) register for details.

### 33.5.8 Register Access Protection

Registers with write-access can be write-protected optionally by the peripheral access controller (PAC).

PAC Write-Protection is not available for the following registers:

- Interrupt Flag Clear and Status register (INTFLAG)
- Status register (STATUS)
- Data register (DATA)

Optional PAC Write-Protection is denoted by the "PAC Write-Protection" property in each individual register description.

Write-protection does not apply to accesses through an external debugger.

**Related Links**

[PAC - Peripheral Access Controller](#)

### 33.5.9 Analog Connections

Not applicable.

## 33.6 Functional Description

### 33.6.1 Principle of Operation

The SPI is a high-speed synchronous data transfer interface. It allows high-speed communication between the device and peripheral devices.

The SPI can operate as master or slave. As master, the SPI initiates and controls all data transactions. The SPI is single buffered for transmitting and double buffered for receiving.

When transmitting data, the Data register can be loaded with the next character to be transmitted during the current transmission.

When receiving, the data is transferred to the two-level receive buffer, and the receiver is ready for a new character.

The SPI transaction format is shown in [SPI Transaction Format](#). Each transaction can contain one or more characters. The character size is configurable, and can be either 8 or 9 bits.

**Figure 33-2. SPI Transaction Format**

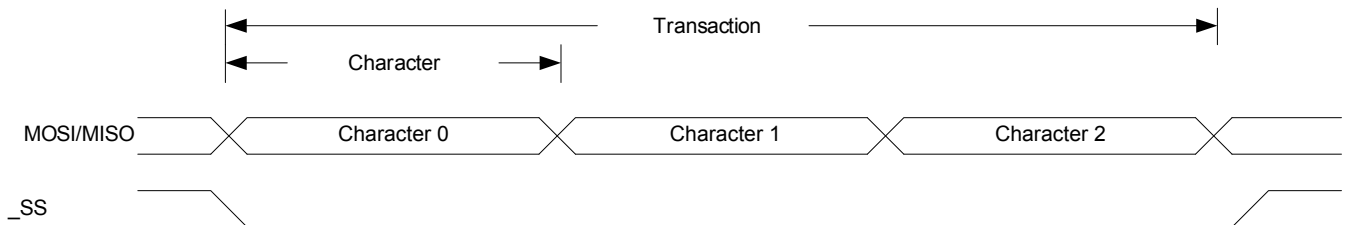

The SPI master must pull the slave select line ( $\overline{SS}$ ) of the desired slave low to initiate a transaction. The master and slave prepare data to send via their respective shift registers, and the master generates the serial clock on the SCK line.

Data are always shifted from master to slave on the Master Output Slave Input line (MOSI); data is shifted from slave to master on the Master Input Slave Output line (MISO).

Each time character is shifted out from the master, a character will be shifted out from the slave simultaneously. To signal the end of a transaction, the master will pull the  $\overline{SS}$  line high.

### 33.6.2 Basic Operation

#### 33.6.2.1 Initialization

The following registers are enable-protected, meaning that they can only be written when the SPI is disabled (CTRL.ENABLE=0):

- Control A register (CTRLA), except Enable (CTRLA.ENABLE) and Software Reset (CTRLA.SWRST)
- Control B register (CTRLB), except Receiver Enable (CTRLB.RXEN)
- Baud register (BAUD)
- Address register (ADDR)

When the SPI is enabled or is being enabled (CTRLA.ENABLE=1), any writing to these registers will be discarded.

when the SPI is being disabled, writing to these registers will be completed after the disabling.

Enable-protection is denoted by the Enable-Protection property in the register description.

Initialize the SPI by following these steps:

1. Select SPI mode in master / slave operation in the Operating Mode bit group in the CTRLA register (CTRLA.MODE= 0x2 or 0x3 ).
2. Select transfer mode for the Clock Polarity bit and the Clock Phase bit in the CTRLA register (CTRLA.CPOL and CTRLA.CPHA) if desired.
3. Select the Frame Format value in the CTRLA register (CTRLA.FORM).
4. Configure the Data In Pinout field in the Control A register (CTRLA.DIPO) for SERCOM pads of the receiver.
5. Configure the Data Out Pinout bit group in the Control A register (CTRLA.DOPO) for SERCOM pads of the transmitter.
6. Select the Character Size value in the CTRLB register (CTRLB.CHSIZE).
7. Write the Data Order bit in the CTRLA register (CTRLA.DORD) for data direction.
8. If the SPI is used in master mode:
  - 8.1. Select the desired baud rate by writing to the Baud register (BAUD).
  - 8.2. If Hardware SS control is required, write '1' to the Master Slave Select Enable bit in CTRLB register (CTRLB.MSSEN).
9. Enable the receiver by writing the Receiver Enable bit in the CTRLB register (CTRLB.RXEN=1).

### 33.6.2.2 Enabling, Disabling, and Resetting

This peripheral is enabled by writing '1' to the Enable bit in the Control A register (CTRLA.ENABLE), and disabled by writing '0' to it.

Writing '1' to the Software Reset bit in the Control A register (CTRLA.SWRST) will reset all registers of this peripheral to their initial states, except the DBGCTRL register, and the peripheral is disabled.

Refer to the CTRLA register description for details.

### 33.6.2.3 Clock Generation

In SPI master operation (CTRLA.MODE=0x3), the serial clock (SCK) is generated internally by the SERCOM baud-rate generator.

In SPI mode, the baud-rate generator is set to synchronous mode. The 8-bit Baud register (BAUD) value is used for generating SCK and clocking the shift register. Refer to *Clock Generation – Baud-Rate Generator* for more details.

In SPI slave operation (CTRLA.MODE is 0x2), the clock is provided by an external master on the SCK pin. This clock is used to directly clock the SPI shift register.

#### Related Links

[Clock Generation – Baud-Rate Generator](#)

[Asynchronous Arithmetic Mode BAUD Value Selection](#)

### 33.6.2.4 Data Register

The SPI Transmit Data register (TxDATA) and SPI Receive Data register (RxDATA) share the same I/O address, referred to as the SPI Data register (DATA). Writing DATA register will update the Transmit Data register. Reading the DATA register will return the contents of the Receive Data register.

### 33.6.2.5 SPI Transfer Modes

There are four combinations of SCK phase and polarity to transfer serial data. The SPI data transfer modes are shown in [SPI Transfer Modes \(Table\)](#) and [SPI Transfer Modes \(Figure\)](#).

SCK phase is configured by the Clock Phase bit in the CTRLA register (CTRLA.CPHA). SCK polarity is programmed by the Clock Polarity bit in the CTRLA register (CTRLA.CPOL). Data bits are shifted out and latched in on opposite edges of the SCK signal. This ensures sufficient time for the data signals to stabilize.

**Table 33-3. SPI Transfer Modes**

Mode	CPOL	CPHA	Leading Edge	Trailing Edge
0	0	0	Rising, sample	Falling, setup
1	0	1	Rising, setup	Falling, sample
2	1	0	Falling, sample	Rising, setup
3	1	1	Falling, setup	Rising, sample

**Note:**

Leading edge is the first clock edge in a clock cycle.

Trailing edge is the second clock edge in a clock cycle.



Figure 33-3. SPI Transfer Modes



### 33.6.2.6 Transferring Data

#### Master

In master mode (CTRLA.MODE=0x3), when Master Slave Enable Select (CTRLB.MSSEN) is '1', hardware will control the  $\overline{SS}$  line.

When Master Slave Select Enable (CTRLB.MSSEN) is '0', the  $\overline{SS}$  line must be configured as an output.  $\overline{SS}$  can be assigned to any general purpose I/O pin. When the SPI is ready for a data transaction, software must pull the  $\overline{SS}$  line low.

When writing a character to the Data register (DATA), the character will be transferred to the shift register. Once the content of TxDATA has been transferred to the shift register, the Data Register Empty flag in the Interrupt Flag Status and Clear register (INTFLAG.DRE) will be set. And a new character can be written to DATA.

Each time one character is shifted out from the master, another character will be shifted in from the slave simultaneously. If the receiver is enabled (CTRLA.RXEN=1), the contents of the shift register will be transferred to the two-level receive buffer. The transfer takes place in the same clock cycle as the last

data bit is shifted in. And the Receive Complete Interrupt flag in the Interrupt Flag Status and Clear register (INTFLAG.RXC) will be set. The received data can be retrieved by reading DATA.

When the last character has been transmitted and there is no valid data in DATA, the Transmit Complete Interrupt flag in the Interrupt Flag Status and Clear register (INTFLAG.TXC) will be set. When the transaction is finished, the master must pull the  $\overline{SS}$  line high to notify the slave. If Master Slave Select Enable (CTRLB.MSSEN) is set to '0', the software must pull the  $\overline{SS}$  line high.

## Slave

In slave mode (CTRLA.MODE=0x2), the SPI interface will remain inactive with the MISO line tri-stated as long as the  $\overline{SS}$  pin is pulled high. Software may update the contents of DATA at any time as long as the Data Register Empty flag in the Interrupt Status and Clear register (INTFLAG.DRE) is set.

When  $\overline{SS}$  is pulled low and SCK is running, the slave will sample and shift out data according to the transaction mode set. When the content of TxDATA has been loaded into the shift register, INTFLAG.DRE will be set, and new data can be written to DATA.

Similar to the master, the slave will receive one character for each character transmitted. A character will be transferred into the two-level receive buffer within the same clock cycle its last data bit is received. The received character can be retrieved from DATA when the Receive Complete interrupt flag (INTFLAG.RXC) is set.

When the master pulls the  $\overline{SS}$  line high, the transaction is done and the Transmit Complete Interrupt flag in the Interrupt Flag Status and Clear register (INTFLAG.TXC) will be set.

After DATA is written it takes up to three SCK clock cycles until the content of DATA is ready to be loaded into the shift register on the next character boundary. As a consequence, the first character transferred in a SPI transaction will not be the content of DATA. This can be avoided by using the preloading feature. Refer to [Preloading of the Slave Shift Register](#).

When transmitting several characters in one SPI transaction, the data has to be written into DATA register with at least three SCK clock cycles left in the current character transmission. If this criteria is not met, the previously received character will be transmitted.

Once the DATA register is empty, it takes three CLK\_SERCOM\_APB cycles for INTFLAG.DRE to be set.

### 33.6.2.7 Receiver Error Bit

The SPI receiver has one error bit: the Buffer Overflow bit (BUFOVF), which can be read from the Status register (STATUS). Once an error happens, the bit will stay set until it is cleared by writing '1' to it. The bit is also automatically cleared when the receiver is disabled.

There are two methods for buffer overflow notification, selected by the immediate buffer overflow notification bit in the Control A register (CTRLA.IBON):

If CTRLA.IBON=1, STATUS.BUFOVF is raised immediately upon buffer overflow. Software can then empty the receive FIFO by reading RxDATA until the receiver complete interrupt flag in the Interrupt Flag Status and Clear register (INTFLAG.RXC) goes low.

If CTRLA.IBON=0, the buffer overflow condition travels with data through the receive FIFO. After the received data is read, STATUS.BUFOVF and INTFLAG.ERROR will be set along with INTFLAG.RXC, and RxDATA will be zero.

### 33.6.3 Additional Features

#### 33.6.3.1 Address Recognition

When the SPI is configured for slave operation (CTRLA.MODE=0x2) with address recognition (CTRLA.FORM is 0x2), the SERCOM address recognition logic is enabled: the first character in a transaction is checked for an address match.

If there is a match, the Receive Complete Interrupt flag in the Interrupt Flag Status and Clear register (INTFLAG.RXC) is set, the MISO output is enabled, and the transaction is processed. If the device is in sleep mode, an address match can wake up the device in order to process the transaction.

If there is no match, the complete transaction is ignored.

If a 9-bit frame format is selected, only the lower 8 bits of the shift register are checked against the Address register (ADDR).

Preload must be disabled (CTRLB.PLOADEN=0) in order to use this mode.

## Related Links

[Address Match and Mask](#)

### 33.6.3.2 Preloading of the Slave Shift Register

When starting a transaction, the slave will first transmit the contents of the shift register before loading new data from DATA. The first character sent can be either the reset value of the shift register (if this is the first transmission since the last reset) or the last character in the previous transmission.

Preloading can be used to preload data into the shift register while  $\overline{SS}$  is high: this eliminates sending a dummy character when starting a transaction. If the shift register is not preloaded, the current contents of the shift register will be shifted out.

Only one data character will be preloaded into the shift register while the synchronized  $\overline{SS}$  signal is high. If the next character is written to DATA before  $\overline{SS}$  is pulled low, the second character will be stored in DATA until transfer begins.

For proper preloading, sufficient time must elapse between  $\overline{SS}$  going low and the first SCK sampling edge, as in [Timing Using Preloading](#). See also *Electrical Characteristics* for timing details.

Preloading is enabled by writing '1' to the Slave Data Preload Enable bit in the CTRLB register (CTRLB.PLOADEN).

**Figure 33-4. Timing Using Preloading**



### 33.6.3.3 Master with Several Slaves

Master with multiple slaves in parallel is only available when Master Slave Select Enable (CTRLB.MSSEN) is set to zero and hardware  $\overline{SS}$  control is disabled. If the bus consists of several SPI slaves, an SPI master can use general purpose I/O pins to control the  $\overline{SS}$  line to each of the slaves on the bus, as shown in [Multiple Slaves in Parallel](#). In this configuration, the single selected SPI slave will drive the tri-state MISO line.

Figure 33-5. Multiple Slaves in Parallel



Another configuration is multiple slaves in series, as in [Multiple Slaves in Series](#). In this configuration, all n attached slaves are connected in series. A common  $\overline{SS}$  line is provided to all slaves, enabling them simultaneously. The master must shift n characters for a complete transaction. Depending on the Master Slave Select Enable bit (CTRLB.MSSEN), the  $\overline{SS}$  line can be controlled either by hardware or user software and normal GPIO.

Figure 33-6. Multiple Slaves in Series



#### 33.6.3.4 Loop-Back Mode

For loop-back mode, configure the Data In Pinout (CTRLA.DIPO) and Data Out Pinout (CTRLA.DOPO) to use the same data pins for transmit and receive. The loop-back is through the pad, so the signal is also available externally.

#### 33.6.3.5 Hardware Controlled $\overline{SS}$

In master mode, a single  $\overline{SS}$  chip select can be controlled by hardware by writing the Master Slave Select Enable (CTRLB.MSSEN) bit to '1'. In this mode, the  $\overline{SS}$  pin is driven low for a minimum of one baud cycle before transmission begins, and stays low for a minimum of one baud cycle after transmission completes. If back-to-back frames are transmitted, the  $\overline{SS}$  pin will always be driven high for a minimum of one baud cycle between frames.

In [Hardware Controlled  \$\overline{SS}\$](#) , the time T is between one and two baud cycles depending on the SPI transfer mode.

Figure 33-7. Hardware Controlled  $\overline{SS}$



T = 1 to 2 baud cycles

When CTRLB.MSEN=0, the  $\overline{SS}$  pin(s) is/are controlled by user software and normal GPIO.

### 33.6.3.6 Slave Select Low Detection

In slave mode, the SPI can wake the CPU when the slave select ( $\overline{SS}$ ) goes low. When the Slave Select Low Detect is enabled (CTRLB.SSDE=1), a high-to-low transition will set the Slave Select Low interrupt flag (INTFLAG.SSL) and the device will wake up if applicable.

### 33.6.4 DMA, Interrupts, and Events

Table 33-4. Module Request for SERCOM SPI

Condition	Request		
	DMA	Interrupt	Event
Data Register Empty (DRE)	Yes (request cleared when data is written)	Yes	NA
Receive Complete (RXC)	Yes (request cleared when data is read)	Yes	
Transmit Complete (TXC)	NA	Yes	
Slave Select low (SSL)	NA	Yes	
Error (ERROR)	NA	Yes	

#### 33.6.4.1 DMA Operation

The SPI generates the following DMA requests:

- Data received (RX): The request is set when data is available in the receive FIFO. The request is cleared when DATA is read.
- Data transmit (TX): The request is set when the transmit buffer (TX DATA) is empty. The request is cleared when DATA is written.

#### 33.6.4.2 Interrupts

The SPI has the following interrupt sources. These are asynchronous interrupts, and can wake up the device from any sleep mode:

- Data Register Empty (DRE)
- Receive Complete (RXC)
- Transmit Complete (TXC)
- Slave Select Low (SSL)
- Error (ERROR)

Each interrupt source has its own interrupt flag. The interrupt flag in the Interrupt Flag Status and Clear register (INTFLAG) will be set when the interrupt condition is met. Each interrupt can be individually

enabled by writing '1' to the corresponding bit in the Interrupt Enable Set register (INTENSET), and disabled by writing '1' to the corresponding bit in the Interrupt Enable Clear register (INTENCLR).

An interrupt request is generated when the interrupt flag is set and if the corresponding interrupt is enabled. The interrupt request remains active until either the interrupt flag is cleared, the interrupt is disabled, or the SPI is reset. For details on clearing interrupt flags, refer to the INTFLAG register description.

The SPI has one common interrupt request line for all the interrupt sources. The value of INTFLAG indicates which interrupt is executed. Note that interrupts must be globally enabled for interrupt requests. Refer to *Nested Vector Interrupt Controller* for details.

#### Related Links

[Nested Vector Interrupt Controller](#)

#### 33.6.4.3 Events

Not applicable.

#### 33.6.5 Sleep Mode Operation

The behavior in sleep mode is depending on the master/slave configuration and the Run In Standby bit in the Control A register (CTRLA.RUNSTDBY):

- Master operation, CTRLA.RUNSTDBY=1: The peripheral clock GCLK\_SERCOM\_CORE will continue to run in idle sleep mode and in standby sleep mode. Any interrupt can wake up the device.
- Master operation, CTRLA.RUNSTDBY=0: GLK\_SERCOMx\_CORE will be disabled after the ongoing transaction is finished. Any interrupt can wake up the device.
- Slave operation, CTRLA.RUNSTDBY=1: The Receive Complete interrupt can wake up the device.
- Slave operation, CTRLA.RUNSTDBY=0: All reception will be dropped, including the ongoing transaction.

#### 33.6.6 Synchronization

Due to asynchronicity between the main clock domain and the peripheral clock domains, some registers need to be synchronized when written or read.

The following bits are synchronized when written:

- Software Reset bit in the CTRLA register (CTRLA.SWRST)
- Enable bit in the CTRLA register (CTRLA.ENABLE)
- Receiver Enable bit in the CTRLB register (CTRLB.RXEN)

**Note:** CTRLB.RXEN is write-synchronized somewhat differently. See also *CTRLB* register for details.

Required write-synchronization is denoted by the "Write-Synchronized" property in the register description.

#### Related Links

[Register Synchronization](#)

## 33.7 Register Summary

Offset	Name	Bit Pos.							
0x00	CTRLA	7:0	RUNSTDBY			MODE[2:0]		ENABLE	SWRST
0x01		15:8							IBON
0x02		23:16			DIPO[1:0]				DOPO[1:0]
0x03		31:24		DORD	CPOL	CPHA		FORM[3:0]	
0x04	CTRLB	7:0		PLOADEN				CHSIZE[2:0]	
0x05		15:8		AMODE[1:0]	MSEN			SSDE	
0x06		23:16						RXEN	
0x07		31:24							
0x08 ... 0x0B	Reserved								
0x0C	BAUD	7:0				BAUD[7:0]			
0x0D ... 0x13	Reserved								
0x14	INTENCLR	7:0	ERROR			SSL	RXC	TXC	DRE
0x15	Reserved								
0x16	INTENSET	7:0	ERROR			SSL	RXC	TXC	DRE
0x17	Reserved								
0x18	INTFLAG	7:0	ERROR			SSL	RXC	TXC	DRE
0x19	Reserved								
0x1A	STATUS	7:0					BUFOVF		
0x1B		15:8							
0x1C	SYNDBUSY	7:0					CTRLB	ENABLE	SWRST
0x1D		15:8							
0x1E		23:16							
0x1F		31:24							
0x20 ... 0x23	Reserved								
0x24	ADDR	7:0				ADDR[7:0]			
0x25		15:8							
0x26		23:16				ADDRMASK[7:0]			
0x27		31:24							
0x28	DATA	7:0				DATA[7:0]			
0x29		15:8							DATA[8:8]
0x2A ... 0x2F	Reserved								
0x30	DBGCTRL	7:0							DBGSTOP

## 33.8 Register Description

Registers can be 8, 16, or 32 bits wide. Atomic 8-, 16-, and 32-bit accesses are supported. In addition, the 8-bit quarters and 16-bit halves of a 32-bit register, and the 8-bit halves of a 16-bit register can be accessed directly.

Some registers require synchronization when read and/or written. Synchronization is denoted by the "Read-Synchronized" and/or "Write-Synchronized" property in each individual register description.

Refer to [Synchronization](#)

Some registers are enable-protected, meaning they can only be written when the module is disabled. Enable-protection is denoted by the "Enable-Protected" property in each individual register description.

Optional write-protection by the Peripheral Access Controller (PAC) is denoted by the "PAC Write-Protection" property in each individual register description.

Refer to [Register Access Protection](#).

### 33.8.1 Control A

**Name:** CTRLA

**Offset:** 0x00 [ID-00000e74]

**Reset:** 0x00000000

**Property:** PAC Write-Protection, Enable-Protected, Write-Synchronized

	Bit	31	30	29	28	27	26	25	24
			DORD	CPOL	CPHA	FORM[3:0]			
Access			R/W	R/W	R/W	R/W	R/W	R/W	R/W
Reset			0	0	0	0	0	0	0
	Bit	23	22	21	20	19	18	17	16
				DIPO[1:0]				DOPO[1:0]	
Access				R/W	R/W			R/W	R/W
Reset				0	0			0	0
	Bit	15	14	13	12	11	10	9	8
									IBON
Access									R/W
Reset									0
	Bit	7	6	5	4	3	2	1	0
		RUNSTDBY			MODE[2:0]			ENABLE	SWRST
Access		R/W			R/W	R/W	R/W	R/W	R/W
Reset		0			0	0	0	0	0

#### Bit 30 – DORD: Data Order

This bit selects the data order when a character is shifted out from the shift register.

This bit is not synchronized.



Value	Description
0	MSB is transferred first.
1	LSB is transferred first.

### Bit 29 – CPOL: Clock Polarity

In combination with the Clock Phase bit (CPHA), this bit determines the SPI transfer mode.

This bit is not synchronized.

Value	Description
0	SCK is low when idle. The leading edge of a clock cycle is a rising edge, while the trailing edge is a falling edge.
1	SCK is high when idle. The leading edge of a clock cycle is a falling edge, while the trailing edge is a rising edge.

### Bit 28 – CPHA: Clock Phase

In combination with the Clock Polarity bit (CPOL), this bit determines the SPI transfer mode.

This bit is not synchronized.

Mode	CPOL	CPHA	Leading Edge	Trailing Edge
0x0	0	0	Rising, sample	Falling, change
0x1	0	1	Rising, change	Falling, sample
0x2	1	0	Falling, sample	Rising, change
0x3	1	1	Falling, change	Rising, sample

Value	Description
0	The data is sampled on a leading SCK edge and changed on a trailing SCK edge.
1	The data is sampled on a trailing SCK edge and changed on a leading SCK edge.

### Bits 27:24 – FORM[3:0]: Frame Format

This bit field selects the various frame formats supported by the SPI in slave mode. When the 'SPI frame with address' format is selected, the first byte received is checked against the ADDR register.

FORM[3:0]	Name	Description
0x0	SPI	SPI frame
0x1	-	Reserved
0x2	SPI_ADDR	SPI frame with address
0x3-0xF	-	Reserved

### Bits 21:20 – DIPO[1:0]: Data In Pinout

These bits define the data in (DI) pad configurations.

In master operation, DI is MISO.

In slave operation, DI is MOSI.

These bits are not synchronized.

DIPO[1:0]	Name	Description
0x0	PAD[0]	SERCOM PAD[0] is used as data input
0x1	PAD[1]	SERCOM PAD[1] is used as data input
0x2	PAD[2]	SERCOM PAD[2] is used as data input
0x3	PAD[3]	SERCOM PAD[3] is used as data input

### Bits 17:16 – DOPO[1:0]: Data Out Pinout

This bit defines the available pad configurations for data out (DO) and the serial clock (SCK). In slave operation, the slave select line ( $\overline{SS}$ ) is controlled by DOPO, while in master operation the  $\overline{SS}$  line is controlled by the port configuration.

In master operation, DO is MOSI.

In slave operation, DO is MISO.

These bits are not synchronized.

DOPO	DO	SCK	Slave $\overline{SS}$	Master $\overline{SS}$
0x0	PAD[0]	PAD[1]	PAD[2]	System configuration
0x1	PAD[2]	PAD[3]	PAD[1]	System configuration
0x2	PAD[3]	PAD[1]	PAD[2]	System configuration
0x3	PAD[0]	PAD[3]	PAD[1]	System configuration

### Bit 8 – IBON: Immediate Buffer Overflow Notification

This bit controls when the buffer overflow status bit (STATUS.BUFOVF) is set when a buffer overflow occurs.

This bit is not synchronized.

Value	Description
0	STATUS.BUFOVF is set when it occurs in the data stream.
1	STATUS.BUFOVF is set immediately upon buffer overflow.

### Bit 7 – RUNSTDBY: Run In Standby

This bit defines the functionality in standby sleep mode.

These bits are not synchronized.

RUNSTDBY	Slave	Master
0x0	Disabled. All reception is dropped, including the ongoing transaction.	Generic clock is disabled when ongoing transaction is finished. All interrupts can wake up the device.
0x1	Ongoing transaction continues, wake on Receive Complete interrupt.	Generic clock is enabled while in sleep modes. All interrupts can wake up the device.

### Bits 4:2 – MODE[2:0]: Operating Mode

These bits must be written to 0x2 or 0x3 to select the SPI serial communication interface of the SERCOM.

0x2: SPI slave operation

0x3: SPI master operation

These bits are not synchronized.

**Bit 1 – ENABLE: Enable**

Due to synchronization, there is delay from writing CTRLA.ENABLE until the peripheral is enabled/disabled. The value written to CTRLA.ENABLE will read back immediately and the Synchronization Enable Busy bit in the Synchronization Busy register (SYNCBUSY.ENABLE) will be set. SYNCBUSY.ENABLE is cleared when the operation is complete.

This bit is not enable-protected.

Value	Description
0	The peripheral is disabled or being disabled.
1	The peripheral is enabled or being enabled.

**Bit 0 – SWRST: Software Reset**

Writing '0' to this bit has no effect.

Writing '1' to this bit resets all registers in the SERCOM, except DBGCTRL, to their initial state, and the SERCOM will be disabled.

Writing "1" to CTRLA.SWRST will always take precedence, meaning that all other writes in the same write-operation will be discarded. Any register write access during the ongoing reset will result in an APB error. Reading any register will return the reset value of the register.

Due to synchronization, there is a delay from writing CTRLA.SWRST until the reset is complete. CTRLA.SWRST and SYNCBUSY.SWRST will both be cleared when the reset is complete.

This bit is not enable-protected.

Value	Description
0	There is no reset operation ongoing.
1	The reset operation is ongoing.

**33.8.2 Control B**

**Name:** CTRLB

**Offset:** 0x04 [ID-00000e74]

**Reset:** 0x00000000

**Property:** PAC Write-Protection, Enable-Protected

Bit	31	30	29	28	27	26	25	24
Access								
Reset								
Bit	23	22	21	20	19	18	17	16
							RXEN	
Access							R/W	
Reset							0	
Bit	15	14	13	12	11	10	9	8
	AMODE[1:0]		MSSSEN			SSDE		
Access	R/W	R/W	R/W			R/W		
Reset	0	0	0			0		
Bit	7	6	5	4	3	2	1	0
			PLOADEN			CHSIZE[2:0]		
Access			R/W			R/W	R/W	R/W
Reset			0			0	0	0

### Bit 17 – RXEN: Receiver Enable

Writing '0' to this bit will disable the SPI receiver immediately. The receive buffer will be flushed, data from ongoing receptions will be lost and STATUS.BUFOVF will be cleared.

Writing '1' to CTRLB.RXEN when the SPI is disabled will set CTRLB.RXEN immediately. When the SPI is enabled, CTRLB.RXEN will be cleared, SYNCBUSY.CTRLB will be set and remain set until the receiver is enabled. When the receiver is enabled CTRLB.RXEN will read back as '1'.

Writing '1' to CTRLB.RXEN when the SPI is enabled will set SYNCBUSY.CTRLB, which will remain set until the receiver is enabled, and CTRLB.RXEN will read back as '1'.

This bit is not enable-protected.

Value	Description
0	The receiver is disabled or being enabled.
1	The receiver is enabled or it will be enabled when SPI is enabled.

### Bits 15:14 – AMODE[1:0]: Address Mode

These bits set the slave addressing mode when the frame format (CTRLA.FORM) with address is used. They are unused in master mode.

AMODE[1:0]	Name	Description
0x0	MASK	ADDRMASK is used as a mask to the ADDR register
0x1	2_ADDRS	The slave responds to the two unique addresses in ADDR and ADDRMASK
0x2	RANGE	The slave responds to the range of addresses between and including ADDR and ADDRMASK. ADDR is the upper limit
0x3	-	Reserved

### Bit 13 – MSSSEN: Master Slave Select Enable

This bit enables hardware slave select ( $\overline{SS}$ ) control.

Value	Description
0	Hardware $\overline{SS}$ control is disabled.
1	Hardware $\overline{SS}$ control is enabled.

### Bit 9 – SSDE: Slave Select Low Detect Enable

This bit enables wake up when the slave select ( $\overline{SS}$ ) pin transitions from high to low.

Value	Description
0	$\overline{SS}$ low detector is disabled.
1	$\overline{SS}$ low detector is enabled.

### Bit 6 – PLOADEN: Slave Data Preload Enable

Setting this bit will enable preloading of the slave shift register when there is no transfer in progress. If the  $\overline{SS}$  line is high when DATA is written, it will be transferred immediately to the shift register.

### Bits 2:0 – CHSIZE[2:0]: Character Size

CHSIZE[2:0]	Name	Description
0x0	8BIT	8 bits
0x1	9BIT	9 bits
0x2-0x7	-	Reserved

## 33.8.3 Baud Rate

**Name:** BAUD

**Offset:** 0x0C [ID-00000e74]

**Reset:** 0x00

**Property:** PAC Write-Protection, Enable-Protected

Bit	7	6	5	4	3	2	1	0
	BAUD[7:0]							
Access	R/W	R/W	R/W	R/W	R/W	R/W	R/W	R/W
Reset	0	0	0	0	0	0	0	0

### Bits 7:0 – BAUD[7:0]: Baud Register

These bits control the clock generation, as described in the *SERCOM Clock Generation – Baud-Rate Generator*.

## 33.8.4 Interrupt Enable Clear

**Name:** INTENCLR

**Offset:** 0x14 [ID-00000e74]

**Reset:** 0x00

**Property:** PAC Write-Protection

Bit	7	6	5	4	3	2	1	0
	ERROR				SSL	RXC	TXC	DRE
Access	R/W				R/W	R/W	R/W	R/W
Reset	0				0	0	0	0

### Bit 7 – ERROR: Error Interrupt Enable

Writing '0' to this bit has no effect.

Writing '1' to this bit will clear the Error Interrupt Enable bit, which disables the Error interrupt.

Value	Description
0	Error interrupt is disabled.
1	Error interrupt is enabled.

### Bit 3 – SSL: Slave Select Low Interrupt Enable

Writing '0' to this bit has no effect.

Writing '1' to this bit will clear the Slave Select Low Interrupt Enable bit, which disables the Slave Select Low interrupt.

Value	Description
0	Slave Select Low interrupt is disabled.
1	Slave Select Low interrupt is enabled.

### Bit 2 – RXC: Receive Complete Interrupt Enable

Writing '0' to this bit has no effect.

Writing '1' to this bit will clear the Receive Complete Interrupt Enable bit, which disables the Receive Complete interrupt.

Value	Description
0	Receive Complete interrupt is disabled.
1	Receive Complete interrupt is enabled.

### Bit 1 – TXC: Transmit Complete Interrupt Enable

Writing '0' to this bit has no effect.

Writing '1' to this bit will clear the Transmit Complete Interrupt Enable bit, which disable the Transmit Complete interrupt.

Value	Description
0	Transmit Complete interrupt is disabled.
1	Transmit Complete interrupt is enabled.

### Bit 0 – DRE: Data Register Empty Interrupt Enable

Writing '0' to this bit has no effect.

Writing '1' to this bit will clear the Data Register Empty Interrupt Enable bit, which disables the Data Register Empty interrupt.

Value	Description
0	Data Register Empty interrupt is disabled.
1	Data Register Empty interrupt is enabled.

## 33.8.5 Interrupt Enable Set

**Name:** INTENSET  
**Offset:** 0x16 [ID-0000e74]  
**Reset:** 0x00  
**Property:** PAC Write-Protection

	7	6	5	4	3	2	1	0
Bit	ERROR				SSL	RXC	TXC	DRE
Access	R/W				R/W	R/W	R/W	R/W
Reset	0				0	0	0	0

### Bit 7 – ERROR: Error Interrupt Enable

Writing '0' to this bit has no effect.

Writing '1' to this bit will set the Error Interrupt Enable bit, which enables the Error interrupt.

Value	Description
0	Error interrupt is disabled.
1	Error interrupt is enabled.

### Bit 3 – SSL: Slave Select Low Interrupt Enable

Writing '0' to this bit has no effect.

Writing '1' to this bit will set the Slave Select Low Interrupt Enable bit, which enables the Slave Select Low interrupt.

Value	Description
0	Slave Select Low interrupt is disabled.
1	Slave Select Low interrupt is enabled.

### Bit 2 – RXC: Receive Complete Interrupt Enable

Writing '0' to this bit has no effect.

Writing '1' to this bit will set the Receive Complete Interrupt Enable bit, which enables the Receive Complete interrupt.

Value	Description
0	Receive Complete interrupt is disabled.
1	Receive Complete interrupt is enabled.

### Bit 1 – TXC: Transmit Complete Interrupt Enable

Writing '0' to this bit has no effect.

Writing '1' to this bit will set the Transmit Complete Interrupt Enable bit, which enables the Transmit Complete interrupt.

Value	Description
0	Transmit Complete interrupt is disabled.
1	Transmit Complete interrupt is enabled.

### Bit 0 – DRE: Data Register Empty Interrupt Enable

Writing '0' to this bit has no effect.

Writing '1' to this bit will set the Data Register Empty Interrupt Enable bit, which enables the Data Register Empty interrupt.

Value	Description
0	Data Register Empty interrupt is disabled.
1	Data Register Empty interrupt is enabled.

### 33.8.6 Interrupt Flag Status and Clear

**Name:** INTFLAG  
**Offset:** 0x18 [ID-00000e74]  
**Reset:** 0x00  
**Property:** -

	7	6	5	4	3	2	1	0
Bit	ERROR				SSL	RXC	TXC	DRE
Access	R/W				R/W	R	R/W	R
Reset	0				0	0	0	0

#### Bit 7 – ERROR: Error

This flag is cleared by writing '1' to it.

This bit is set when any error is detected. Errors that will set this flag have corresponding status flags in the STATUS register. The BUFOVF error will set this interrupt flag.

Writing '0' to this bit has no effect.

Writing '1' to this bit will clear the flag.

#### Bit 3 – SSL: Slave Select Low

This flag is cleared by writing '1' to it.

This bit is set when a high to low transition is detected on the `_SS` pin in slave mode and Slave Select Low Detect (CTRLB.SSDE) is enabled.

Writing '0' to this bit has no effect.

Writing '1' to this bit will clear the flag.

#### Bit 2 – RXC: Receive Complete

This flag is cleared by reading the Data (DATA) register or by disabling the receiver.

This flag is set when there are unread data in the receive buffer. If address matching is enabled, the first data received in a transaction will be an address.

Writing '0' to this bit has no effect.

Writing '1' to this bit has no effect.

#### Bit 1 – TXC: Transmit Complete

This flag is cleared by writing '1' to it or by writing new data to DATA.

In master mode, this flag is set when the data have been shifted out and there are no new data in DATA.

In slave mode, this flag is set when the `_SS` pin is pulled high. If address matching is enabled, this flag is only set if the transaction was initiated with an address match.

Writing '0' to this bit has no effect.

Writing '1' to this bit will clear the flag.



## Bit 0 – DRE: Data Register Empty

This flag is cleared by writing new data to DATA.

This flag is set when DATA is empty and ready for new data to transmit.

Writing '0' to this bit has no effect.

Writing '1' to this bit has no effect.

### 33.8.7 Status

**Name:** STATUS

**Offset:** 0x1A [ID-00000e74]

**Reset:** 0x0000

**Property:** –



## Bit 2 – BUFOVF: Buffer Overflow

Reading this bit before reading DATA will indicate the error status of the next character to be read.

This bit is cleared by writing '1' to the bit or by disabling the receiver.

This bit is set when a buffer overflow condition is detected. See also [CTRLA.IBON](#) for overflow handling.

When set, the corresponding RxDATA will be zero.

Writing '0' to this bit has no effect.

Writing '1' to this bit will clear it.

Value	Description
0	No Buffer Overflow has occurred.
1	A Buffer Overflow has occurred.

### 33.8.8 Synchronization Busy

**Name:** SYNCBUSY

**Offset:** 0x1C [ID-00000e74]

**Reset:** 0x00000000

**Property:** -

Bit	31	30	29	28	27	26	25	24
Access								
Reset								
Bit	23	22	21	20	19	18	17	16
Access								
Reset								
Bit	15	14	13	12	11	10	9	8
Access								
Reset								
Bit	7	6	5	4	3	2	1	0
						CTRLB	ENABLE	SWRST
Access						R	R	R
Reset						0	0	0

**Bit 2 – CTRLB: CTRLB Synchronization Busy**

Writing to the CTRLB when the SERCOM is enabled requires synchronization. Ongoing synchronization is indicated by SYNCBUSY.CTRLB=1 until synchronization is complete. If CTRLB is written while SYNCBUSY.CTRLB=1, an APB error will be generated.

Value	Description
0	CTRLB synchronization is not busy.
1	CTRLB synchronization is busy.

**Bit 1 – ENABLE: SERCOM Enable Synchronization Busy**

Enabling and disabling the SERCOM (CTRLA.ENABLE) requires synchronization. Ongoing synchronization is indicated by SYNCBUSY.ENABLE=1 until synchronization is complete.

Writes to any register (except for CTRLA.SWRST) while enable synchronization is on-going will be discarded and an APB error will be generated.

Value	Description
0	Enable synchronization is not busy.
1	Enable synchronization is busy.

**Bit 0 – SWRST: Software Reset Synchronization Busy**

Resetting the SERCOM (CTRLA.SWRST) requires synchronization. Ongoing synchronization is indicated by SYNCBUSY.SWRST=1 until synchronization is complete.

Writes to any register while synchronization is on-going will be discarded and an APB error will be generated.

Value	Description
0	SWRST synchronization is not busy.
1	SWRST synchronization is busy.

**33.8.9 Address**

**Name:** ADDR  
**Offset:** 0x24 [ID-00000e74]  
**Reset:** 0x00000000  
**Property:** PAC Write-Protection, Enable-Protected

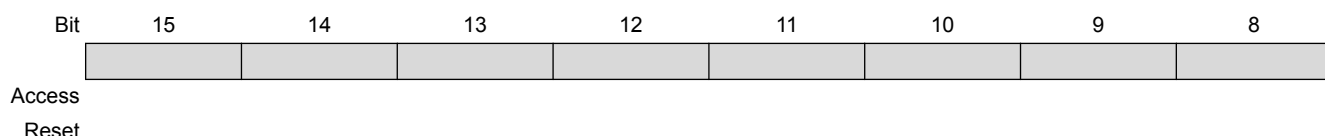
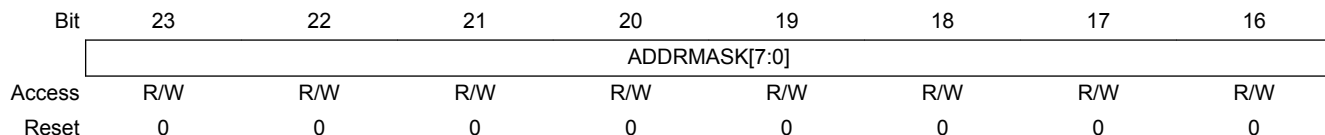

**Bits 23:16 – ADDRMASK[7:0]: Address Mask**

These bits hold the address mask when the transaction format with address is used (CTRLA.FORM, CTRLB.AMODE).

**Bits 7:0 – ADDR[7:0]: Address**

These bits hold the address when the transaction format with address is used (CTRLA.FORM, CTRLB.AMODE).

### 33.8.10 Data

**Name:** DATA  
**Offset:** 0x28 [ID-00000e74]  
**Reset:** 0x0000  
**Property:** –

Bit	15	14	13	12	11	10	9	8
	DATA[8:8]							DATA[8:8]
Access								R/W
Reset								0
Bit	7	6	5	4	3	2	1	0
	DATA[7:0]							
Access	R/W	R/W	R/W	R/W	R/W	R/W	R/W	R/W
Reset	0	0	0	0	0	0	0	0

**Bits 8:0 – DATA[8:0]: Data**

Reading these bits will return the contents of the receive data buffer. The register should be read only when the Receive Complete Interrupt Flag bit in the Interrupt Flag Status and Clear register (INTFLAG.RXC) is set.

Writing these bits will write the transmit data buffer. This register should be written only when the Data Register Empty Interrupt Flag bit in the Interrupt Flag Status and Clear register (INTFLAG.DRE) is set.

### 33.8.11 Debug Control

**Name:** DBGCTRL  
**Offset:** 0x30 [ID-00000e74]  
**Reset:** 0x00  
**Property:** PAC Write-Protection

Bit	7	6	5	4	3	2	1	0
	DBGSTOP							DBGSTOP
Access								R/W
Reset								0

**Bit 0 – DBGSTOP: Debug Stop Mode**

This bit controls the functionality when the CPU is halted by an external debugger.

Value	Description
0	The baud-rate generator continues normal operation when the CPU is halted by an external debugger.
1	The baud-rate generator is halted when the CPU is halted by an external debugger.

## 34. SERCOM I<sup>2</sup>C – SERCOM Inter-Integrated Circuit

### 34.1 Overview

The inter-integrated circuit (I<sup>2</sup>C) interface is one of the available modes in the serial communication interface (SERCOM).

The I<sup>2</sup>C interface uses the SERCOM transmitter and receiver configured as shown in [Figure 34-1](#). Labels in capital letters are registers accessible by the CPU, while lowercase labels are internal to the SERCOM.

A SERCOM instance can be configured to be either an I<sup>2</sup>C master or an I<sup>2</sup>C slave. Both master and slave have an interface containing a shift register, a transmit buffer and a receive buffer. In addition, the I<sup>2</sup>C master uses the SERCOM baud-rate generator, while the I<sup>2</sup>C slave uses the SERCOM address match logic.

#### Related Links

[SERCOM – Serial Communication Interface](#)

### 34.2 Features

SERCOM I<sup>2</sup>C includes the following features:

- Master or slave operation
- Can be used with DMA
- Philips I<sup>2</sup>C compatible
- SMBus™ compatible
- PMBus compatible
- Support of 100kHz and 400kHz, 1MHz and 3.4MHz I<sup>2</sup>C mode
- 4-Wire operation supported
- Physical interface includes:
  - Slew-rate limited outputs
  - Filtered inputs
- Slave operation:
  - Operation in all sleep modes
  - Wake-up on address match
  - 7-bit and 10-bit Address match in hardware for:
    - Unique address and/or 7-bit general call address
    - Address range
    - Two unique addresses can be used with DMA

#### Related Links

[Features](#)

## 34.3 Block Diagram

Figure 34-1. I<sup>2</sup>C Single-Master Single-Slave Interconnection



## 34.4 Signal Description

Signal Name	Type	Description
PAD[0]	Digital I/O	SDA
PAD[1]	Digital I/O	SCL
PAD[2]	Digital I/O	SDA_OUT (4-wire operation)
PAD[3]	Digital I/O	SDC_OUT (4-wire operation)

One signal can be mapped on several pins.

Not all the pins are I<sup>2</sup>C pins.

### Related Links

[I/O Multiplexing and Considerations](#)

## 34.5 Product Dependencies

In order to use this peripheral, other parts of the system must be configured correctly, as described below.

### 34.5.1 I/O Lines

In order to use the I/O lines of this peripheral, the I/O pins must be configured using the I/O Pin Controller (PORT).

When the SERCOM is used in I<sup>2</sup>C mode, the SERCOM controls the direction and value of the I/O pins. Both PORT control bits PINCFGn.PULLEN and PINCFGn.DRVSTR are still effective. If the receiver or transmitter is disabled, these pins can be used for other purposes.

### Related Links

[PORT: IO Pin Controller](#)

### 34.5.2 Power Management

This peripheral can continue to operate in any sleep mode where its source clock is running. The interrupts can wake up the device from sleep modes.

## Related Links

[PM – Power Manager](#)

### 34.5.3 Clocks

The SERCOM bus clock (CLK\_SERCOMx\_APB) can be enabled and disabled in the Main Clock Controller. Refer to *Peripheral Clock Masking* for details and default status of this clock.

Two generic clocks are used by SERCOM, GCLK\_SERCOMx\_CORE and GCLK\_SERCOM\_SLOW. The core clock (GCLK\_SERCOMx\_CORE) can clock the I<sup>2</sup>C when working as a master. The slow clock (GCLK\_SERCOM\_SLOW) is required only for certain functions, e.g. SMBus timing. These clocks must be configured and enabled in the Generic Clock Controller (GCLK) before using the I<sup>2</sup>C.

These generic clocks are asynchronous to the bus clock (CLK\_SERCOMx\_APB). Due to this asynchronicity, writes to certain registers will require synchronization between the clock domains. Refer to [Synchronization](#) for further details.

## Related Links

[GCLK - Generic Clock Controller](#)

[Peripheral Clock Masking](#)

[PM – Power Manager](#)

### 34.5.4 DMA

The DMA request lines are connected to the DMA Controller (DMAC). In order to use DMA requests with this peripheral the DMAC must be configured first. Refer to *DMAC – Direct Memory Access Controller* for details.

## Related Links

[DMAC – Direct Memory Access Controller](#)

### 34.5.5 Interrupts

The interrupt request line is connected to the Interrupt Controller. In order to use interrupt requests of this peripheral, the Interrupt Controller (NVIC) must be configured first. Refer to *Nested Vector Interrupt Controller* for details.

## Related Links

[Nested Vector Interrupt Controller](#)

### 34.5.6 Events

Not applicable.

### 34.5.7 Debug Operation

When the CPU is halted in debug mode, this peripheral will continue normal operation. If the peripheral is configured to require periodical service by the CPU through interrupts or similar, improper operation or data loss may result during debugging. This peripheral can be forced to halt operation during debugging - refer to the Debug Control (DBGCTRL) register for details.

### 34.5.8 Register Access Protection

Registers with write-access can be write-protected optionally by the peripheral access controller (PAC).

PAC Write-Protection is not available for the following registers:

- Interrupt Flag Clear and Status register (INTFLAG)
- Status register (STATUS)

- Data register (DATA)
- Address register (ADDR)

Optional PAC Write-Protection is denoted by the "PAC Write-Protection" property in each individual register description.

Write-protection does not apply to accesses through an external debugger.

**Related Links**

[PAC - Peripheral Access Controller](#)

### 34.5.9 Analog Connections

Not applicable.

## 34.6 Functional Description

### 34.6.1 Principle of Operation

The I<sup>2</sup>C interface uses two physical lines for communication:

- Serial Data Line (SDA) for packet transfer
- Serial Clock Line (SCL) for the bus clock

A transaction starts with the I<sup>2</sup>C master sending the start condition, followed by a 7-bit address and a direction bit (read or write to/from the slave).

The addressed I<sup>2</sup>C slave will then acknowledge (ACK) the address, and data packet transactions can begin. Every 9-bit data packet consists of 8 data bits followed by a one-bit reply indicating whether the data was acknowledged or not.

If a data packet is not acknowledged (NACK), whether by the I<sup>2</sup>C slave or master, the I<sup>2</sup>C master takes action by either terminating the transaction by sending the stop condition, or by sending a repeated start to transfer more data.

The figure below illustrates the possible transaction formats and [Transaction Diagram Symbols](#) explains the transaction symbols. These symbols will be used in the following descriptions.



**Figure 34-2. Basic I<sup>2</sup>C Transaction Diagram**







## Transaction Diagram Symbols



### Bus Driver

	Master driving bus
	Slave driving bus
	Either Master or Slave driving bus



### Special Bus Conditions

	START condition
	repeated START condition
	STOP condition

### Data Package Direction

	Master Read
'1'	
	Master Write
'0'	

### Acknowledge

	Acknowledge (ACK)
'0'	
	Not Acknowledge (NACK)
'1'	

## 34.6.2 Basic Operation

### 34.6.2.1 Initialization

The following registers are enable-protected, meaning they can be written only when the I<sup>2</sup>C interface is disabled (CTRLA.ENABLE is '0'):

- Control A register (CTRLA), except Enable (CTRLA.ENABLE) and Software Reset (CTRLA.SWRST) bits
- Control B register (CTRLB), except Acknowledge Action (CTRLB.ACKACT) and Command (CTRLB.CMD) bits
- Baud register (BAUD)
- Address register (ADDR) in slave operation.

When the I<sup>2</sup>C is enabled or is being enabled (CTRLA.ENABLE=1), writing to these registers will be discarded. If the I<sup>2</sup>C is being disabled, writing to these registers will be completed after the disabling.

Enable-protection is denoted by the "Enable-Protection" property in the register description.

Before the I<sup>2</sup>C is enabled it must be configured as outlined by the following steps:

1. Select I<sup>2</sup>C Master or Slave mode by writing 0x4 or 0x5 to the Operating Mode bits in the CTRLA register (CTRLA.MODE).
2. If desired, select the SDA Hold Time value in the CTRLA register (CTRLA.SDAHOLD).
3. If desired, enable smart operation by setting the Smart Mode Enable bit in the CTRLB register (CTRLB.SMEN).
4. If desired, enable SCL low time-out by setting the SCL Low Time-Out bit in the Control A register (CTRLA.LOWTOUT).
5. In Master mode:
  - 5.1. Select the inactive bus time-out in the Inactive Time-Out bit group in the CTRLA register (CTRLA.INACTOUT).
  - 5.2. Write the Baud Rate register (BAUD) to generate the desired baud rate.

In Slave mode:

- 5.1. Configure the address match configuration by writing the Address Mode value in the CTRLB register (CTRLB.AMODE).
- 5.2. Set the Address and Address Mask value in the Address register (ADDR.ADDR and ADDR.ADDRMASK) according to the address configuration.

### 34.6.2.2 Enabling, Disabling, and Resetting

This peripheral is enabled by writing '1' to the Enable bit in the Control A register (CTRLA.ENABLE), and disabled by writing '0' to it.

Refer to [CTRLA](#) for details.

### 34.6.2.3 I<sup>2</sup>C Bus State Logic

The bus state logic includes several logic blocks that continuously monitor the activity on the I<sup>2</sup>C bus lines in all sleep modes. The start and stop detectors and the bit counter are all essential in the process of determining the current bus state. The bus state is determined according to [Bus State Diagram](#). Software can get the current bus state by reading the Master Bus State bits in the Status register (STATUS.BUSSTATE). The value of STATUS.BUSSTATE in the figure is shown in binary.

**Figure 34-3. Bus State Diagram**



The bus state machine is active when the I<sup>2</sup>C master is enabled.

After the I<sup>2</sup>C master has been enabled, the bus state is UNKNOWN (0b00). From the UNKNOWN state, the bus will transition to IDLE (0b01) by either:

- Forcing by writing 0b01 to STATUS.BUSSTATE
- A stop condition is detected on the bus
- If the inactive bus time-out is configured for SMBus compatibility (CTRLA.INACTOUT) and a time-out occurs.

**Note:** Once a known bus state is established, the bus state logic will not re-enter the UNKNOWN state.

When the bus is IDLE it is ready for a new transaction. If a start condition is issued on the bus by another I<sup>2</sup>C master in a multi-master setup, the bus becomes BUSY (0b11). The bus will re-enter IDLE either

when a stop condition is detected, or when a time-out occurs (inactive bus time-out needs to be configured).

If a start condition is generated internally by writing the Address bit group in the Address register (ADDR.ADDR) while IDLE, the OWNER state (0b10) is entered. If the complete transaction was performed without interference, i.e., arbitration was not lost, the I<sup>2</sup>C master can issue a stop condition, which will change the bus state back to IDLE.

However, if a packet collision is detected while in OWNER state, the arbitration is assumed lost and the bus state becomes BUSY until a stop condition is detected. A repeated start condition will change the bus state only if arbitration is lost while issuing a repeated start.

Regardless of winning or losing arbitration, the entire address will be sent. If arbitration is lost, only 'ones' are transmitted from the point of losing arbitration and the rest of the address length.

**Note:** Violating the protocol may cause the I<sup>2</sup>C to hang. If this happens it is possible to recover from this state by a software reset (CTRLA.SWRST='1').

#### Related Links

[CTRLA](#)

#### 34.6.2.4 I<sup>2</sup>C Master Operation

The I<sup>2</sup>C master is byte-oriented and interrupt based. The number of interrupts generated is kept at a minimum by automatic handling of most events. The software driver complexity and code size are reduced by auto-triggering of operations, and a special smart mode, which can be enabled by the Smart Mode Enable bit in the Control A register (CTRLA.SMEN).

The I<sup>2</sup>C master has two interrupt strategies.

When SCL Stretch Mode (CTRLA.SCLSM) is '0', SCL is stretched before or after the acknowledge bit. In this mode the I<sup>2</sup>C master operates according to [Master Behavioral Diagram \(SCLSM=0\)](#). The circles labelled "Mn" (M1, M2..) indicate the nodes the bus logic can jump to, based on software or hardware interaction.

This diagram is used as reference for the description of the I<sup>2</sup>C master operation throughout the document.

**Figure 34-4. I<sup>2</sup>C Master Behavioral Diagram (SCLSM=0)**



In the second strategy (CTRLA.SCLSM=1), interrupts only occur after the ACK bit, as in [Master Behavioral Diagram \(SCLSM=1\)](#). This strategy can be used when it is not necessary to check DATA before acknowledging.

**Note:** I<sup>2</sup>C High-speed (*Hs*) mode requires CTRLA.SCLSM=1.

Figure 34-5. I<sup>2</sup>C Master Behavioral Diagram (SCLSM=1)



### Master Clock Generation

The SERCOM peripheral supports several I<sup>2</sup>C bi-directional modes:

- Standard mode (*Sm*) up to 100kHz
- Fast mode (*Fm*) up to 400kHz
- Fast mode Plus (*Fm+*) up to 1MHz
- High-speed mode (*Hs*) up to 3.4MHz

The Master clock configuration for *Sm*, *Fm*, and *Fm+* are described in [Clock Generation \(Standard-Mode, Fast-Mode, and Fast-Mode Plus\)](#). For *Hs*, refer to [Master Clock Generation \(High-Speed Mode\)](#).

### Clock Generation (Standard-Mode, Fast-Mode, and Fast-Mode Plus)

In I<sup>2</sup>C *Sm*, *Fm*, and *Fm+* mode, the Master clock (SCL) frequency is determined as described in this section:

The low ( $T_{LOW}$ ) and high ( $T_{HIGH}$ ) times are determined by the Baud Rate register (BAUD), while the rise ( $T_{RISE}$ ) and fall ( $T_{FALL}$ ) times are determined by the bus topology. Because of the wired-AND logic of the bus,  $T_{FALL}$  will be considered as part of  $T_{LOW}$ . Likewise,  $T_{RISE}$  will be in a state between  $T_{LOW}$  and  $T_{HIGH}$  until a high state has been detected.

Figure 34-6. SCL Timing



The following parameters are timed using the SCL low time period  $T_{LOW}$ . This comes from the Master Baud Rate Low bit group in the Baud Rate register (BAUD.BAUDLOW). When BAUD.BAUDLOW=0, or the Master Baud Rate bit group in the Baud Rate register (BAUD.BAUD) determines it.

- $T_{LOW}$  – Low period of SCL clock
- $T_{SU;STO}$  – Set-up time for stop condition
- $T_{BUF}$  – Bus free time between stop and start conditions
- $T_{HD;STA}$  – Hold time (repeated) start condition
- $T_{SU;STA}$  – Set-up time for repeated start condition
- $T_{HIGH}$  is timed using the SCL high time count from BAUD.BAUD
- $T_{RISE}$  is determined by the bus impedance; for internal pull-ups. Refer to *Electrical Characteristics*.
- $T_{FALL}$  is determined by the open-drain current limit and bus impedance; can typically be regarded as zero. Refer to *Electrical Characteristics* for details.

The SCL frequency is given by:

$$f_{SCL} = \frac{1}{T_{LOW} + T_{HIGH} + T_{RISE}}$$

When BAUD.BAUDLOW is zero, the BAUD.BAUD value is used to time both SCL high and SCL low. In this case the following formula will give the SCL frequency:

$$f_{SCL} = \frac{f_{GCLK}}{10 + 2BAUD + f_{GCLK} \cdot T_{RISE}}$$

When BAUD.BAUDLOW is non-zero, the following formula determines the SCL frequency:

$$f_{SCL} = \frac{f_{GCLK}}{10 + BAUD + BAUDLOW + f_{GCLK} \cdot T_{RISE}}$$

The following formulas can determine the SCL  $T_{LOW}$  and  $T_{HIGH}$  times:

$$T_{LOW} = \frac{BAUDLOW + 5}{f_{GCLK}}$$

$$T_{HIGH} = \frac{BAUD + 5}{f_{GCLK}}$$

**Note:** The I<sup>2</sup>C standard *Fm+* (Fast-mode plus) requires a nominal high to low SCL ratio of 1:2, and BAUD should be set accordingly. At a minimum, BAUD.BAUD and/or BAUD.BAUDLOW must be non-zero.

**Startup Timing** The minimum time between SDA transition and SCL rising edge is 6 APB cycles when the DATA register is written in smart mode. If a greater startup time is required due to long rise times, the time between DATA write and IF clear must be controlled by software.

**Note:** When timing is controlled by user, the Smart Mode cannot be enabled.

## Related Links

[Electrical Characteristics 85°C \(SAM C20J/G/E\)](#)

### **Master Clock Generation (High-Speed Mode)**

For I<sup>2</sup>C *Hs* transfers, there is no SCL synchronization. Instead, the SCL frequency is determined by the GCLK\_SERCOMx\_CORE frequency ( $f_{GCLK}$ ) and the High-Speed Baud setting in the Baud register (BAUD.HSBAUD). When BAUD.HSBAUDLOW=0, the HSBAUD value will determine both SCL high and SCL low. In this case the following formula determines the SCL frequency.

$$f_{SCL} = \frac{f_{GCLK}}{2 + 2 \cdot HSBAUD}$$

When HSBAUDLOW is non-zero, the following formula determines the SCL frequency.

$$f_{SCL} = \frac{f_{GCLK}}{2 + HSBAUD + HSBAUDLOW}$$

**Note:** The I<sup>2</sup>C standard *Hs* (High-speed) requires a nominal high to low SCL ratio of 1:2, and HSBAUD should be set accordingly. At a minimum, BAUD.HSBAUD and/or BAUD.HSBAUDLOW must be non-zero.

### **Transmitting Address Packets**

The I<sup>2</sup>C master starts a bus transaction by writing the I<sup>2</sup>C slave address to ADDR.ADDR and the direction bit, as described in [Principle of Operation](#). If the bus is busy, the I<sup>2</sup>C master will wait until the bus becomes idle before continuing the operation. When the bus is idle, the I<sup>2</sup>C master will issue a start condition on the bus. The I<sup>2</sup>C master will then transmit an address packet using the address written to ADDR.ADDR. After the address packet has been transmitted by the I<sup>2</sup>C master, one of four cases will arise according to arbitration and transfer direction.

#### **Case 1: Arbitration lost or bus error during address packet transmission**

If arbitration was lost during transmission of the address packet, the Master on Bus bit in the Interrupt Flag Status and Clear register (INTFLAG.MB) and the Arbitration Lost bit in the Status register (STATUS.ARBLOST) are both set. Serial data output to SDA is disabled, and the SCL is released, which disables clock stretching. In effect the I<sup>2</sup>C master is no longer allowed to execute any operation on the bus until the bus is idle again. A bus error will behave similarly to the arbitration lost condition. In this case, the MB interrupt flag and Master Bus Error bit in the Status register (STATUS.BUSERR) are both set in addition to STATUS.ARBLOST.

The Master Received Not Acknowledge bit in the Status register (STATUS.RXNACK) will always contain the last successfully received acknowledge or not acknowledge indication.

In this case, software will typically inform the application code of the condition and then clear the interrupt flag before exiting the interrupt routine. No other flags have to be cleared at this moment, because all flags will be cleared automatically the next time the ADDR.ADDR register is written.

#### **Case 2: Address packet transmit complete – No ACK received**

If there is no I<sup>2</sup>C slave device responding to the address packet, then the INTFLAG.MB interrupt flag and STATUS.RXNACK will be set. The clock hold is active at this point, preventing further activity on the bus.

The missing ACK response can indicate that the I<sup>2</sup>C slave is busy with other tasks or sleeping. Therefore, it is not able to respond. In this event, the next step can be either issuing a stop condition (recommended) or resending the address packet by a repeated start condition. When using SMBus logic, the slave must ACK the address. If there is no response, it means that the slave is not available on the bus.

### Case 3: Address packet transmit complete – Write packet, Master on Bus set

If the I<sup>2</sup>C master receives an acknowledge response from the I<sup>2</sup>C slave, INTFLAG.MB will be set and STATUS.RXNACK will be cleared. The clock hold is active at this point, preventing further activity on the bus.

In this case, the software implementation becomes highly protocol dependent. Three possible actions can enable the I<sup>2</sup>C operation to continue:

- Initiate a data transmit operation by writing the data byte to be transmitted into DATA.DATA.
- Transmit a new address packet by writing ADDR.ADDR. A repeated start condition will automatically be inserted before the address packet.
- Issue a stop condition, consequently terminating the transaction.

### Case 4: Address packet transmit complete – Read packet, Slave on Bus set

If the I<sup>2</sup>C master receives an ACK from the I<sup>2</sup>C slave, the I<sup>2</sup>C master proceeds to receive the next byte of data from the I<sup>2</sup>C slave. When the first data byte is received, the Slave on Bus bit in the Interrupt Flag register (INTFLAG.SB) will be set and STATUS.RXNACK will be cleared. The clock hold is active at this point, preventing further activity on the bus.

In this case, the software implementation becomes highly protocol dependent. Three possible actions can enable the I<sup>2</sup>C operation to continue:

- Let the I<sup>2</sup>C master continue to read data by acknowledging the data received. ACK can be sent by software, or automatically in smart mode.
- Transmit a new address packet.
- Terminate the transaction by issuing a stop condition.

**Note:** An ACK or NACK will be automatically transmitted if smart mode is enabled. The Acknowledge Action bit in the Control B register (CTRLB.ACKACT) determines whether ACK or NACK should be sent.

### Transmitting Data Packets

When an address packet with direction Master Write (see [Figure 34-2](#)) was transmitted successfully, INTFLAG.MB will be set. The I<sup>2</sup>C master will start transmitting data via the I<sup>2</sup>C bus by writing to DATA.DATA, and monitor continuously for packet collisions. I

If a collision is detected, the I<sup>2</sup>C master will lose arbitration and STATUS.ARBLOST will be set. If the transmit was successful, the I<sup>2</sup>C master will receive an ACK bit from the I<sup>2</sup>C slave, and STATUS.RXNACK will be cleared. INTFLAG.MB will be set in both cases, regardless of arbitration outcome.

It is recommended to read STATUS.ARBLOST and handle the arbitration lost condition in the beginning of the I<sup>2</sup>C Master on Bus interrupt. This can be done as there is no difference between handling address and data packet arbitration.

STATUS.RXNACK must be checked for each data packet transmitted before the next data packet transmission can commence. The I<sup>2</sup>C master is not allowed to continue transmitting data packets if a NACK is received from the I<sup>2</sup>C slave.

### Receiving Data Packets (SCLSM=0)

When INTFLAG.SB is set, the I<sup>2</sup>C master will already have received one data packet. The I<sup>2</sup>C master must respond by sending either an ACK or NACK. Sending a NACK may be unsuccessful when



arbitration is lost during the transmission. In this case, a lost arbitration will prevent setting INTFLAG.SB. Instead, INTFLAG.MB will indicate a change in arbitration. Handling of lost arbitration is the same as for data bit transmission.

### Receiving Data Packets (SCLSM=1)

When INTFLAG.SB is set, the I<sup>2</sup>C master will already have received one data packet and transmitted an ACK or NACK, depending on CTRLB.ACKACT. At this point, CTRLB.ACKACT must be set to the correct value for the next ACK bit, and the transaction can continue by reading DATA and issuing a command if not in the smart mode.

### High-Speed Mode

High-speed transfers are a multi-step process, see [High Speed Transfer](#).

First, a master code (0b00001nnn, where 'nnn' is a unique master code) is transmitted in Full-speed mode, followed by a NACK since no slave should acknowledge. Arbitration is performed only during the Full-speed Master Code phase. The master code is transmitted by writing the master code to the address register (ADDR.ADDR) and writing the high-speed bit (ADDR.HS) to '0'.

After the master code and NACK have been transmitted, the master write interrupt will be asserted. In the meanwhile, the slave address can be written to the ADDR.ADDR register together with ADDR.HS=1. Now in High-speed mode, the master will generate a repeated start, followed by the slave address with RW-direction. The bus will remain in High-speed mode until a stop is generated. If a repeated start is desired, the ADDR.HS bit must again be written to '1', along with the new address ADDR.ADDR to be transmitted.

**Figure 34-7. High Speed Transfer**



Transmitting in High-speed mode requires the I<sup>2</sup>C master to be configured in High-speed mode (CTRLA.SPEED=0x2) and the SCL clock stretch mode (CTRLA.SCLSM) bit set to '1'.

### 10-Bit Addressing

When 10-bit addressing is enabled by the Ten Bit Addressing Enable bit in the Address register (ADDR.TENBITEN=1) and the Address bit field ADDR.ADDR is written, the two address bytes will be transmitted, see [10-bit Address Transmission for a Read Transaction](#). The addressed slave acknowledges the two address bytes, and the transaction continues. Regardless of whether the transaction is a read or write, the master must start by sending the 10-bit address with the direction bit (ADDR.ADDR[0]) being zero.

If the master receives a NACK after the first byte, the write interrupt flag will be raised and the STATUS.RXNACK bit will be set. If the first byte is acknowledged by one or more slaves, then the master will proceed to transmit the second address byte and the master will first see the write interrupt flag after the second byte is transmitted. If the transaction direction is read-from-slave, the 10-bit address transmission must be followed by a repeated start and the first 7 bits of the address with the read/write bit equal to '1'.

**Figure 34-8. 10-bit Address Transmission for a Read Transaction**



This implies the following procedure for a 10-bit read operation:

1. Write the 10-bit address to ADDR.ADDR[10:1]. ADDR.TENBITEN must be '1', the direction bit (ADDR.ADDR[0]) must be '0' (can be written simultaneously with ADDR).
2. Once the Master on Bus interrupt is asserted, Write ADDR[7:0] register to '11110 address[9:8] 1'. ADDR.TENBITEN must be cleared (can be written simultaneously with ADDR).
3. Proceed to transmit data.

### 34.6.2.5 I<sup>2</sup>C Slave Operation

The I<sup>2</sup>C slave is byte-oriented and interrupt-based. The number of interrupts generated is kept at a minimum by automatic handling of most events. The software driver complexity and code size are reduced by auto-triggering of operations, and a special smart mode, which can be enabled by the Smart Mode Enable bit in the Control A register (CTRLA.SMEN).

The I<sup>2</sup>C slave has two interrupt strategies.

When SCL Stretch Mode bit (CTRLA.SCLSM) is '0', SCL is stretched before or after the acknowledge bit. In this mode, the I<sup>2</sup>C slave operates according to [I<sup>2</sup>C Slave Behavioral Diagram \(SCLSM=0\)](#). The circles labelled "Sn" (S1, S2..) indicate the nodes the bus logic can jump to, based on software or hardware interaction.

This diagram is used as reference for the description of the I<sup>2</sup>C slave operation throughout the document.

**Figure 34-9. I<sup>2</sup>C Slave Behavioral Diagram (SCLSM=0)**

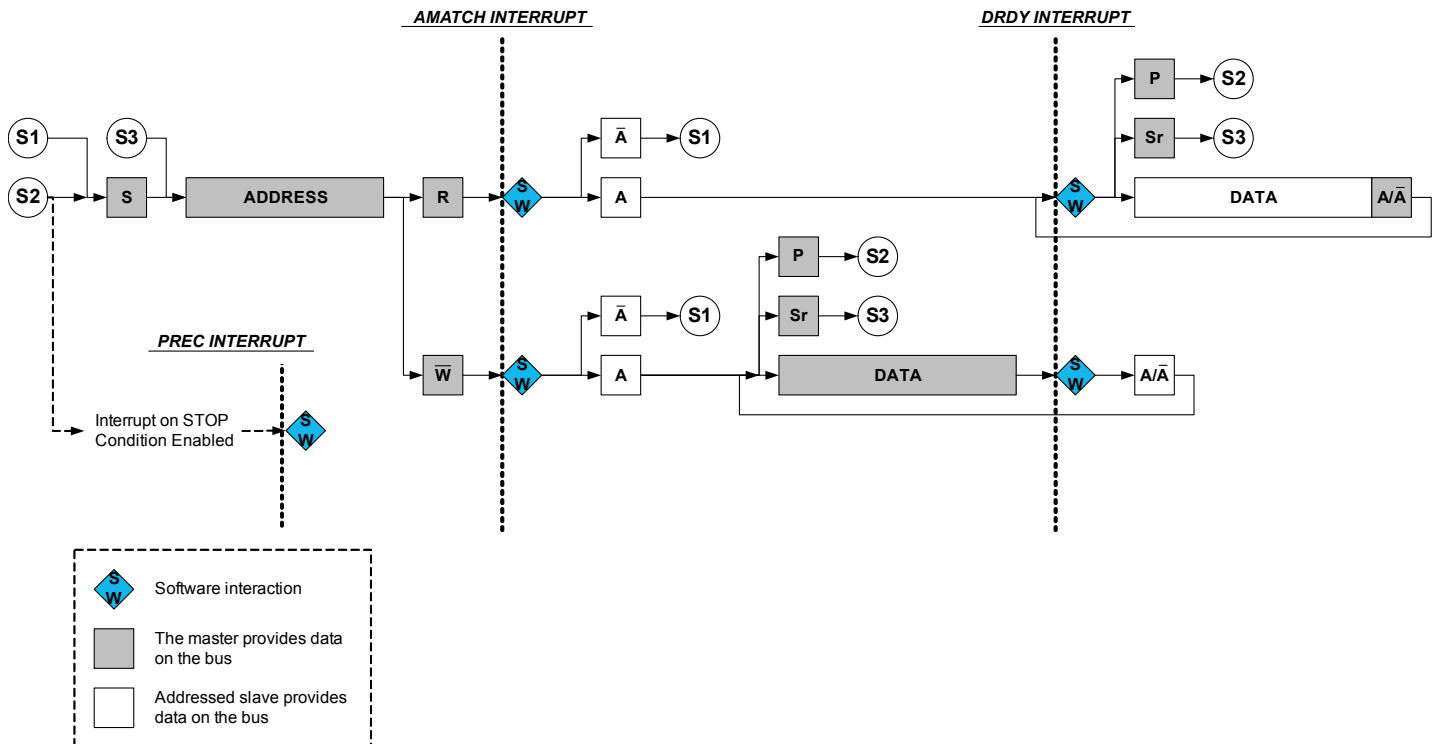

In the second strategy (CTRLA.SCLSM=1), interrupts only occur after the ACK bit is sent as shown in [Slave Behavioral Diagram \(SCLSM=1\)](#). This strategy can be used when it is not necessary to check

DATA before acknowledging. For master reads, an address and data interrupt will be issued simultaneously after the address acknowledge. However, for master writes, the first data interrupt will be seen after the first data byte has been received by the slave and the acknowledge bit has been sent to the master.

**Note:** For I<sup>2</sup>C High-speed mode (*Hs*), SCLSM=1 is required.

**Figure 34-10. I<sup>2</sup>C Slave Behavioral Diagram (SCLSM=1)**



### Receiving Address Packets (SCLSM=0)

When CTRLA.SCLSM=0, the I<sup>2</sup>C slave stretches the SCL line according to Figure 34-9. When the I<sup>2</sup>C slave is properly configured, it will wait for a start condition.

When a start condition is detected, the successive address packet will be received and checked by the address match logic. If the received address is not a match, the packet will be rejected, and the I<sup>2</sup>C slave will wait for a new start condition. If the received address is a match, the Address Match bit in the Interrupt Flag register (INTFLAG.AMATCH) will be set.

SCL will be stretched until the I<sup>2</sup>C slave clears INTFLAG.AMATCH. As the I<sup>2</sup>C slave holds the clock by forcing SCL low, the software has unlimited time to respond.

The direction of a transaction is determined by reading the Read / Write Direction bit in the Status register (STATUS.DIR). This bit will be updated only when a valid address packet is received.

If the Transmit Collision bit in the Status register (STATUS.COLL) is set, this indicates that the last packet addressed to the I<sup>2</sup>C slave had a packet collision. A collision causes the SDA and SCL lines to be released without any notification to software. Therefore, the next AMATCH interrupt is the first indication of the previous packet's collision. Collisions are intended to follow the SMBus Address Resolution Protocol (ARP).

After the address packet has been received from the I<sup>2</sup>C master, one of two cases will arise based on transfer direction.

#### Case 1: Address packet accepted – Read flag set

The STATUS.DIR bit is '1', indicating an I<sup>2</sup>C master read operation. The SCL line is forced low, stretching the bus clock. If an ACK is sent, I<sup>2</sup>C slave hardware will set the Data Ready bit in the Interrupt Flag

register (INTFLAG.DRDY), indicating data are needed for transmit. If a NACK is sent, the I<sup>2</sup>C slave will wait for a new start condition and address match.

Typically, software will immediately acknowledge the address packet by sending an ACK/NACK bit. The I<sup>2</sup>C slave Command bit field in the Control B register (CTRLB.COMD) can be written to '0x3' for both read and write operations as the command execution is dependent on the STATUS.DIR bit. Writing '1' to INTFLAG.AMATCH will also cause an ACK/NACK to be sent corresponding to the CTRLB.ACKACT bit.

## Case 2: Address packet accepted – Write flag set

The STATUS.DIR bit is cleared, indicating an I<sup>2</sup>C master write operation. The SCL line is forced low, stretching the bus clock. If an ACK is sent, the I<sup>2</sup>C slave will wait for data to be received. Data, repeated start or stop can be received.

If a NACK is sent, the I<sup>2</sup>C slave will wait for a new start condition and address match. Typically, software will immediately acknowledge the address packet by sending an ACK/NACK. The I<sup>2</sup>C slave command CTRLB.COMD = 3 can be used for both read and write operation as the command execution is dependent on STATUS.DIR.

Writing '1' to INTFLAG.AMATCH will also cause an ACK/NACK to be sent corresponding to the CTRLB.ACKACT bit.

## Receiving Address Packets (SCLSM=1)

When SCLSM=1, the I<sup>2</sup>C slave will stretch the SCL line only after an ACK, see [Slave Behavioral Diagram \(SCLSM=1\)](#). When the I<sup>2</sup>C slave is properly configured, it will wait for a start condition to be detected.

When a start condition is detected, the successive address packet will be received and checked by the address match logic.

If the received address is not a match, the packet will be rejected and the I<sup>2</sup>C slave will wait for a new start condition.

If the address matches, the acknowledge action as configured by the Acknowledge Action bit Control B register (CTRLB.ACKACT) will be sent and the Address Match bit in the Interrupt Flag register (INTFLAG.AMATCH) is set. SCL will be stretched until the I<sup>2</sup>C slave clears INTFLAG.AMATCH. As the I<sup>2</sup>C slave holds the clock by forcing SCL low, the software is given unlimited time to respond to the address.

The direction of a transaction is determined by reading the Read/Write Direction bit in the Status register (STATUS.DIR). This bit will be updated only when a valid address packet is received.

If the Transmit Collision bit in the Status register (STATUS.COLL) is set, the last packet addressed to the I<sup>2</sup>C slave had a packet collision. A collision causes the SDA and SCL lines to be released without any notification to software. The next AMATCH interrupt is, therefore, the first indication of the previous packet's collision. Collisions are intended to follow the SMBus Address Resolution Protocol (ARP).

After the address packet has been received from the I<sup>2</sup>C master, INTFLAG.AMATCH be set to '1' to clear it.

## Receiving and Transmitting Data Packets

After the I<sup>2</sup>C slave has received an address packet, it will respond according to the direction either by waiting for the data packet to be received or by starting to send a data packet by writing to DATA.DATA. When a data packet is received or sent, INTFLAG.DRDY will be set. After receiving data, the I<sup>2</sup>C slave will send an acknowledge according to CTRLB.ACKACT.

## Case 1: Data received

INTFLAG.DRDY is set, and SCL is held low, pending for SW interaction.

## Case 2: Data sent

When a byte transmission is successfully completed, the INTFLAG.DRDY interrupt flag is set. If NACK is received, indicated by STATUS.RXNACK=1, the I<sup>2</sup>C slave must expect a stop or a repeated start to be received. The I<sup>2</sup>C slave must release the data line to allow the I<sup>2</sup>C master to generate a stop or repeated start. Upon detecting a stop condition, the Stop Received bit in the Interrupt Flag register (INTFLAG.PREC) will be set and the I<sup>2</sup>C slave will return to IDLE state.

### High-Speed Mode

When the I<sup>2</sup>C slave is configured in High-speed mode (*Hs*, CTRLA.SPEED=0x2) and CTRLA.SCLSM=1, switching between Full-speed and High-speed modes is automatic. When the slave recognizes a START followed by a master code transmission and a NACK, it automatically switches to High-speed mode and sets the High-speed status bit (STATUS.HS). The slave will then remain in High-speed mode until a STOP is received.

### 10-Bit Addressing

When 10-bit addressing is enabled (ADDR.TENBITEN=1), the two address bytes following a START will be checked against the 10-bit slave address recognition. The first byte of the address will always be acknowledged, and the second byte will raise the address interrupt flag, see [10-bit Addressing](#).

If the transaction is a write, then the 10-bit address will be followed by *N* data bytes.

If the operation is a read, the 10-bit address will be followed by a repeated START and reception of '11110 ADDR[9:8] 1', and the second address interrupt will be received with the DIR bit set. The slave matches on the second address as it it was addressed by the previous 10-bit address.

**Figure 34-11. 10-bit Addressing**

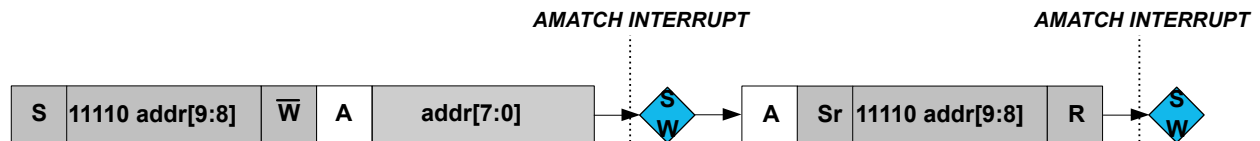

### PMBus Group Command

When the PMBus Group Command bit in the CTRLB register is set (CTRLB.GCMD=1) and 7-bit addressing is used, INTFLAG.PREC will be set when a STOP condition is detected on the bus. When CTRLB.GCMD=0, a STOP condition without address match will not be set INTFLAG.PREC.

The group command protocol is used to send commands to more than one device. The commands are sent in one continuous transmission with a single STOP condition at the end. When the STOP condition is detected by the slaves addressed during the group command, they all begin executing the command they received.

[PMBus Group Command Example](#) shows an example where this slave, bearing ADDRESS 1, is addressed after a repeated START condition. There can be multiple slaves addressed before and after this slave. Eventually, at the end of the group command, a single STOP is generated by the master. At this point a STOP interrupt is asserted.

**Figure 34-12. PMBus Group Command Example**



### 34.6.3 Additional Features

#### 34.6.3.1 SMBus

The I<sup>2</sup>C includes three hardware SCL low time-outs which allow a time-out to occur for SMBus SCL low time-out, master extend time-out, and slave extend time-out. This allows for SMBus functionality. These time-outs are driven by the GCLK\_SERCOM\_SLOW clock. The GCLK\_SERCOM\_SLOW clock is used to accurately time the time-out and must be configured to use a 32KHz oscillator. The I<sup>2</sup>C interface also allows for a SMBus compatible SDA hold time.

- **T<sub>TIMEOUT</sub>**: SCL low time of 25..35ms – Measured for a single SCL low period. It is enabled by CTRLA.LOWTOUTEN.
- **T<sub>LOW:SEXT</sub>**: Cumulative clock low extend time of 25 ms – Measured as the cumulative SCL low extend time by a slave device in a single message from the initial START to the STOP. It is enabled by CTRLA.SEXTTOEN.
- **T<sub>LOW:MEXT</sub>**: Cumulative clock low extend time of 10 ms – Measured as the cumulative SCL low extend time by the master device within a single byte from START-to-ACK, ACK-to-ACK, or ACK-to-STOP. It is enabled by CTRLA.MEXTTOEN.

#### 34.6.3.2 Smart Mode

The I<sup>2</sup>C interface has a smart mode that simplifies application code and minimizes the user interaction needed to adhere to the I<sup>2</sup>C protocol. The smart mode accomplishes this by automatically issuing an ACK or NACK (based on the content of CTRLB.ACKACT) as soon as DATA.DATA is read.

#### 34.6.3.3 4-Wire Mode

Writing a '1' to the Pin Usage bit in the Control A register (CTRLA.PINOUT) will enable 4-wire mode operation. In this mode, the internal I<sup>2</sup>C tri-state drivers are bypassed, and an external I<sup>2</sup>C compliant tri-state driver is needed when connecting to an I<sup>2</sup>C bus.

**Figure 34-13. I<sup>2</sup>C Pad Interface**



### 34.6.3.4 Quick Command

Setting the Quick Command Enable bit in the Control B register (CTRLB.QCEN) enables quick command. When quick command is enabled, the corresponding interrupt flag (INTFLAG.SB or INTFLAG.MB) is set immediately after the slave acknowledges the address. At this point, the software can either issue a stop command or a repeated start by writing CTRLB.CMD or ADDR.ADDR.

### 34.6.4 DMA, Interrupts and Events

**Table 34-1. Module Request for SERCOM I<sup>2</sup>C Slave**

Condition	Request		
	DMA	Interrupt	Event
Data needed for transmit (TX) (Slave transmit mode)	Yes (request cleared when data is written)		NA
Data received (RX) (Slave receive mode)	Yes (request cleared when data is read)		
Data Ready (DRDY)		Yes	
Address Match (AMATCH)		Yes	
Stop received (PREC)		Yes	
Error (ERROR)		Yes	

**Table 34-2. Module Request for SERCOM I<sup>2</sup>C Master**

Condition	Request		
	DMA	Interrupt	Event
Data needed for transmit (TX) (Master transmit mode)	Yes (request cleared when data is written)		NA
Data needed for transmit (RX) (Master transmit mode)	Yes (request cleared when data is read)		
Master on Bus (MB)		Yes	

Condition	Request		
	DMA	Interrupt	Event
Stop received (SB)		Yes	
Error (ERROR)		Yes	

### 34.6.4.1 DMA Operation

Smart mode must be enabled for DMA operation in the Control B register by writing CTRLB.SMEN=1.

#### Slave DMA

When using the I<sup>2</sup>C slave with DMA, an address match will cause the address interrupt flag (INTFLAG.ADDRMATCH) to be raised. After the interrupt has been serviced, data transfer will be performed through DMA.

The I<sup>2</sup>C slave generates the following requests:

- Write data received (RX): The request is set when master write data is received. The request is cleared when DATA is read.
- Read data needed for transmit (TX): The request is set when data is needed for a master read operation. The request is cleared when DATA is written.

#### Master DMA

When using the I<sup>2</sup>C master with DMA, the ADDR register must be written with the desired address (ADDR.ADDR), transaction length (ADDR.LEN), and transaction length enable (ADDR.LENEN). When ADDR.LENEN is written to 1 along with ADDR.ADDR, ADDR.LEN determines the number of data bytes in the transaction from 0 to 255. DMA is then used to transfer ADDR.LEN bytes followed by an automatically generated NACK (for master reads) and a STOP.

If a NACK is received by the slave for a master write transaction before ADDR.LEN bytes, a STOP will be automatically generated and the length error (STATUS.LENERR) will be raised along with the INTFLAG.ERROR interrupt.

The I<sup>2</sup>C master generates the following requests:

- Read data received (RX): The request is set when master read data is received. The request is cleared when DATA is read.
- Write data needed for transmit (TX): The request is set when data is needed for a master write operation. The request is cleared when DATA is written.

### 34.6.4.2 Interrupts

The I<sup>2</sup>C slave has the following interrupt sources. These are asynchronous interrupts. They can wake-up the device from any sleep mode:

- Error (ERROR)
- Data Ready (DRDY)
- Address Match (AMATCH)
- Stop Received (PREC)

The I<sup>2</sup>C master has the following interrupt sources. These are asynchronous interrupts. They can wake-up the device from any sleep mode:

- Error (ERROR)
- Slave on Bus (SB)
- Master on Bus (MB)



Each interrupt source has its own interrupt flag. The interrupt flag in the Interrupt Flag Status and Clear register (INTFLAG) will be set when the interrupt condition is met. Each interrupt can be individually enabled by writing '1' to the corresponding bit in the Interrupt Enable Set register (INTENSET), and disabled by writing '1' to the corresponding bit in the Interrupt Enable Clear register (INTENCLR). An interrupt request is generated when the interrupt flag is set and the corresponding interrupt is enabled. The interrupt request is active until the interrupt flag is cleared, the interrupt is disabled or the I<sup>2</sup>C is reset. See [INTFLAG](#) register for details on how to clear interrupt flags.

The I<sup>2</sup>C has one common interrupt request line for all the interrupt sources. The value of INTFLAG indicates which interrupt is executed. Note that interrupts must be globally enabled for interrupt requests. Refer to *Nested Vector Interrupt Controller* for details.

#### Related Links

[Nested Vector Interrupt Controller](#)

#### 34.6.4.3 Events

Not applicable.

#### 34.6.5 Sleep Mode Operation I<sup>2</sup>C Master Operation

The generic clock (GCLK\_SERCOMx\_CORE) will continue to run in idle sleep mode. If the Run In Standby bit in the Control A register (CTRLA.RUNSTDBY) is '1', the GLK\_SERCOMx\_CORE will also run in standby sleep mode. Any interrupt can wake up the device.

If CTRLA.RUNSTDBY=0, the GLK\_SERCOMx\_CORE will be disabled after any ongoing transaction is finished. Any interrupt can wake up the device.

#### I<sup>2</sup>C Slave Operation

Writing CTRLA.RUNSTDBY=1 will allow the Address Match interrupt to wake up the device.

When CTRLA.RUNSTDBY=0, all receptions will be dropped.

#### 34.6.6 Synchronization

Due to asynchronicity between the main clock domain and the peripheral clock domains, some registers need to be synchronized when written or read.

The following bits are synchronized when written:

- Software Reset bit in the CTRLA register (CTRLA.SWRST)
- Enable bit in the CTRLA register (CTRLA.ENABLE)
- Write to Bus State bits in the Status register (STATUS.BUSSTATE)
- Address bits in the Address register (ADDR.ADDR) when in master operation.

The following registers are synchronized when written:

- Data (DATA) when in master operation

Required write-synchronization is denoted by the "Write-Synchronized" property in the register description.

#### Related Links

[Register Synchronization](#)

### 34.7 Register Summary - I2C Slave

Offset	Name	Bit Pos.								
0x00	CTRLA	7:0	RUNSTDBY			MODE[2:0]		ENABLE	SWRST	
0x01		15:8								
0x02		23:16	SEXTTOEN		SDAHOLD[1:0]				PINOUT	
0x03		31:24		LOWTOUT			SCLSM		SPEED[1:0]	
0x04	CTRLB	7:0								
0x05		15:8	AMODE[1:0]				AACKEN	GCMD	SMEN	
0x06		23:16					ACKACT	CMD[1:0]		
0x07		31:24								
0x08 ... 0x13	Reserved									
0x14	INTENCLR	7:0	ERROR				DRDY	AMATCH	PREC	
0x15	Reserved									
0x16	INTENSET	7:0	ERROR				DRDY	AMATCH	PREC	
0x17	Reserved									
0x18	INTFLAG	7:0	ERROR				DRDY	AMATCH	PREC	
0x19	Reserved									
0x1A	STATUS	7:0	CLKHOLD	LOWTOUT		SR	DIR	RXNACK	COLL	BUSERR
0x1B		15:8						LENERR	SEXTTOUT	
0x1C	SYNDBUSY	7:0							ENABLE	SWRST
0x1D		15:8								
0x1E		23:16								
0x1F		31:24								
0x20 ... 0x23	Reserved									
0x24	ADDR	7:0	ADDR[6:0]						GENCEN	
0x25		15:8	TENBITEN					ADDR[9:7]		
0x26		23:16	ADDRMASK[6:0]							
0x27		31:24						ADDRMASK[9:7]		
0x28	DATA	7:0	DATA[7:0]							
0x29		15:8								

### 34.8 Register Description - I<sup>2</sup>C Slave

Registers can be 8, 16, or 32 bits wide. Atomic 8-, 16- and 32-bit accesses are supported. In addition, the 8-bit quarters and 16-bit halves of a 32-bit register, and the 8-bit halves of a 16-bit register can be accessed directly.

Some registers are optionally write-protected by the Peripheral Access Controller (PAC). Optional PAC write-protection is denoted by the "PAC Write-Protection" property in each individual register description. For details, refer to [Register Access Protection](#).

Some registers are synchronized when read and/or written. Synchronization is denoted by the "Write-Synchronized" or the "Read-Synchronized" property in each individual register description. For details, refer to [Synchronization](#).

Some registers are enable-protected, meaning they can only be written when the peripheral is disabled. Enable-protection is denoted by the "Enable-Protected" property in each individual register description.

## 34.8.1 Control A

**Name:** CTRLA

**Offset:** 0x00 [ID-00001bb3]

**Reset:** 0x00000000

**Property:** PAC Write-Protection, Enable-Protected, Write-Synchronized

Bit	31		30		29		28		27		26		25		24
	LOWTOUT						SCLSM				SPEED[1:0]				
Access	R/W						R/W				R/W				R/W
Reset	0						0				0				0
Bit	23		22		21		20		19		18		17		16
	SEXTTOEN				SDAHOLD[1:0]										PINOUT
Access	R/W				R/W		R/W								R/W
Reset	0				0		0								0
Bit	15		14		13		12		11		10		9		8
Access															
Reset															
Bit	7		6		5		4		3		2		1		0
	RUNSTDBY								MODE[2:0]				ENABLE	SWRST	
Access	R/W						R/W		R/W		R/W		R/W		R/W
Reset	0						0		0		0		0		0

### Bit 30 – LOWTOUT: SCL Low Time-Out

This bit enables the SCL low time-out. If SCL is held low for 25ms-35ms, the slave will release its clock hold, if enabled, and reset the internal state machine. Any interrupt flags set at the time of time-out will remain set.

Value	Description
0	Time-out disabled.
1	Time-out enabled.

### Bit 27 – SCLSM: SCL Clock Stretch Mode

This bit controls when SCL will be stretched for software interaction.

This bit is not synchronized.

Value	Description
0	SCL stretch according to <a href="#">Figure 34-9</a>
1	SCL stretch only after ACK bit according to <a href="#">Figure 34-10</a>

### Bits 25:24 – SPEED[1:0]: Transfer Speed

These bits define bus speed.

These bits are not synchronized.

Value	Description
0x0	Standard-mode (Sm) up to 100 kHz and Fast-mode (Fm) up to 400 kHz
0x1	Fast-mode Plus (Fm+) up to 1 MHz
0x2	High-speed mode (Hs-mode) up to 3.4 MHz
0x3	Reserved

### Bit 23 – SEXTTOEN: Slave SCL Low Extend Time-Out

This bit enables the slave SCL low extend time-out. If SCL is cumulatively held low for greater than 25ms from the initial START to a STOP, the slave will release its clock hold if enabled and reset the internal state machine. Any interrupt flags set at the time of time-out will remain set. If the address was recognized, PREC will be set when a STOP is received.

This bit is not synchronized.

Value	Description
0	Time-out disabled
1	Time-out enabled

### Bits 21:20 – SDAHOLD[1:0]: SDA Hold Time

These bits define the SDA hold time with respect to the negative edge of SCL.

These bits are not synchronized.

Value	Name	Description
0x0	DIS	Disabled
0x1	75	50-100ns hold time
0x2	450	300-600ns hold time
0x3	600	400-800ns hold time

### Bit 16 – PINOUT: Pin Usage

This bit sets the pin usage to either two- or four-wire operation:

This bit is not synchronized.

Value	Description
0	4-wire operation disabled
1	4-wire operation enabled

### Bit 7 – RUNSTDBY: Run in Standby

This bit defines the functionality in standby sleep mode.

This bit is not synchronized.

Value	Description
0	Disabled – All reception is dropped.
1	Wake on address match, if enabled.

### Bits 4:2 – MODE[2:0]: Operating Mode

These bits must be written to 0x04 to select the I<sup>2</sup>C slave serial communication interface of the SERCOM.

These bits are not synchronized.

### Bit 1 – ENABLE: Enable

Due to synchronization, there is delay from writing CTRLA.ENABLE until the peripheral is enabled/disabled. The value written to CTRLA.ENABLE will read back immediately and the Enable Synchronization

Busy bit in the Synchronization Busy register (SYNCBUSY.ENABLE) will be set. SYNCBUSY.ENABLE will be cleared when the operation is complete.

This bit is not enable-protected.

Value	Description
0	The peripheral is disabled or being disabled.
1	The peripheral is enabled.

### Bit 0 – SWRST: Software Reset

Writing '0' to this bit has no effect.

Writing '1' to this bit resets all registers in the SERCOM, except DBGCTRL, to their initial state, and the SERCOM will be disabled.

Writing '1' to CTRLA.SWRST will always take precedence, meaning that all other writes in the same write-operation will be discarded. Any register write access during the ongoing reset will result in an APB error. Reading any register will return the reset value of the register.

Due to synchronization, there is a delay from writing CTRLA.SWRST until the reset is complete. CTRLA.SWRST and SYNCBUSY.SWRST will both be cleared when the reset is complete.

This bit is not enable-protected.

Value	Description
0	There is no reset operation ongoing.
1	The reset operation is ongoing.

## 34.8.2 Control B

**Name:** CTRLB

**Offset:** 0x04 [ID-00001bb3]

**Reset:** 0x00000000

**Property:** PAC Write-Protection, Enable-Protected, Write-Synchronized

Bit	31	30	29	28	27	26	25	24
Access								
Reset								
Bit	23	22	21	20	19	18	17	16
						ACKACT	CMD[1:0]	
Access						R/W	R/W	R/W
Reset						0	0	0
Bit	15	14	13	12	11	10	9	8
	AMODE[1:0]					AACKEN	GCMD	SMEN
Access	R/W	R/W				R/W	R/W	R/W
Reset	0	0				0	0	0
Bit	7	6	5	4	3	2	1	0
Access								
Reset								

### Bit 18 – ACKACT: Acknowledge Action

This bit defines the slave's acknowledge behavior after an address or data byte is received from the master. The acknowledge action is executed when a command is written to the CMD bits. If smart mode is enabled (CTRLB.SMEN=1), the acknowledge action is performed when the DATA register is read.

This bit is not enable-protected.

Value	Description
0	Send ACK
1	Send NACK

### Bits 17:16 – CMD[1:0]: Command

This bit field triggers the slave operation as the below. The CMD bits are strobe bits, and always read as zero. The operation is dependent on the slave interrupt flags, INTFLAG.DRDY and INTFLAG.AMATCH, in addition to STATUS.DIR.

All interrupt flags (INTFLAG.DRDY, INTFLAG.AMATCH and INTFLAG.PREC) are automatically cleared when a command is given.

This bit is not enable-protected.

**Table 34-3. Command Description**

CMD[1:0]	DIR	Action
0x0	X	(No action)
0x1	X	(Reserved)
0x2	Used to complete a transaction in response to a data interrupt (DRDY)	
	0 (Master write)	Execute acknowledge action succeeded by waiting for any start (S/Sr) condition
	1 (Master read)	Wait for any start (S/Sr) condition

CMD[1:0]	DIR	Action
0x3	Used in response to an address interrupt (AMATCH)	
	0 (Master write)	Execute acknowledge action succeeded by reception of next byte
	1 (Master read)	Execute acknowledge action succeeded by slave data interrupt
	Used in response to a data interrupt (DRDY)	
	0 (Master write)	Execute acknowledge action succeeded by reception of next byte
	1 (Master read)	Execute a byte read operation followed by ACK/NACK reception

### Bits 15:14 – AMODE[1:0]: Address Mode

These bits set the addressing mode.

These bits are not write-synchronized.

Value	Name	Description
0x0	MASK	The slave responds to the address written in ADDR.ADDR masked by the value in ADDR.ADDRMASK. See <i>SERCOM – Serial Communication Interface</i> for additional information.
0x1	2_ADDRS	The slave responds to the two unique addresses in ADDR.ADDR and ADDR.ADDRMASK.
0x2	RANGE	The slave responds to the range of addresses between and including ADDR.ADDR and ADDR.ADDRMASK. ADDR.ADDR is the upper limit.
0x3	-	Reserved.

### Bit 10 – AACKEN: Automatic Acknowledge Enable

This bit enables the address to be automatically acknowledged if there is an address match.

This bit is not write-synchronized.

Value	Description
0	Automatic acknowledge is disabled.
1	Automatic acknowledge is enabled.

### Bit 9 – GCMD: PMBus Group Command

This bit enables PMBus group command support. When enabled, the Stop Recived interrupt flag (INTFLAG.PREC) will be set when a STOP condition is detected if the slave has been addressed since the last STOP condition on the bus.

This bit is not write-synchronized.

Value	Description
0	Group command is disabled.
1	Group command is enabled.

### Bit 8 – SMEN: Smart Mode Enable

When smart mode is enabled, data is acknowledged automatically when DATA.DATA is read.

This bit is not write-synchronized.

Value	Description
0	Smart mode is disabled.
1	Smart mode is enabled.

### 34.8.3 Interrupt Enable Clear

This register allows the user to disable an interrupt without doing a read-modify-write operation. Changes in this register will also be reflected in the Interrupt Enable Set register (INTENSET).

**Name:** INTENCLR  
**Offset:** 0x14 [ID-00001bb3]  
**Reset:** 0x00  
**Property:** PAC Write-Protection

	7	6	5	4	3	2	1	0
	ERROR					DRDY	AMATCH	PREC
Access	R/W					R/W	R/W	R/W
Reset	0					0	0	0

#### Bit 7 – ERROR: Error Interrupt Enable

Writing '0' to this bit has no effect.

Writing '1' to this bit will clear the Error Interrupt Enable bit, which disables the Error interrupt.

Value	Description
0	Error interrupt is disabled.
1	Error interrupt is enabled.

#### Bit 2 – DRDY: Data Ready Interrupt Enable

Writing '0' to this bit has no effect.

Writing '1' to this bit will clear the Data Ready bit, which disables the Data Ready interrupt.

Value	Description
0	The Data Ready interrupt is disabled.
1	The Data Ready interrupt is enabled.

#### Bit 1 – AMATCH: Address Match Interrupt Enable

Writing '0' to this bit has no effect.

Writing '1' to this bit will clear the Address Match Interrupt Enable bit, which disables the Address Match interrupt.

Value	Description
0	The Address Match interrupt is disabled.
1	The Address Match interrupt is enabled.

#### Bit 0 – PREC: Stop Received Interrupt Enable

Writing '0' to this bit has no effect.

Writing '1' to this bit will clear the Stop Received Interrupt Enable bit, which disables the Stop Received interrupt.

Value	Description
0	The Stop Received interrupt is disabled.
1	The Stop Received interrupt is enabled.



## 34.8.4 Interrupt Enable Set

This register allows the user to enable an interrupt without doing a read-modify-write operation. Changes in this register will also be reflected in the Interrupt Enable Clear register (INTENCLR).

**Name:** INTENSET  
**Offset:** 0x16 [ID-00001bb3]  
**Reset:** 0x00  
**Property:** PAC Write-Protection

Bit	7	6	5	4	3	2	1	0
	ERROR					DRDY	AMATCH	PREC
Access	R/W					R/W	R/W	R/W
Reset	0					0	0	0

### Bit 7 – ERROR: Error Interrupt Enable

Writing '0' to this bit has no effect.

Writing '1' to this bit will set the Error Interrupt Enable bit, which enables the Error interrupt.

Value	Description
0	Error interrupt is disabled.
1	Error interrupt is enabled.

### Bit 2 – DRDY: Data Ready Interrupt Enable

Writing '0' to this bit has no effect.

Writing '1' to this bit will set the Data Ready bit, which enables the Data Ready interrupt.

Value	Description
0	The Data Ready interrupt is disabled.
1	The Data Ready interrupt is enabled.

### Bit 1 – AMATCH: Address Match Interrupt Enable

Writing '0' to this bit has no effect.

Writing '1' to this bit will set the Address Match Interrupt Enable bit, which enables the Address Match interrupt.

Value	Description
0	The Address Match interrupt is disabled.
1	The Address Match interrupt is enabled.

### Bit 0 – PREC: Stop Received Interrupt Enable

Writing '0' to this bit has no effect.

Writing '1' to this bit will set the Stop Received Interrupt Enable bit, which enables the Stop Received interrupt.

Value	Description
0	The Stop Received interrupt is disabled.
1	The Stop Received interrupt is enabled.

## 34.8.5 Interrupt Flag Status and Clear

**Name:** INTFLAG  
**Offset:** 0x18 [ID-00001bb3]  
**Reset:** 0x00  
**Property:** -

	7	6	5	4	3	2	1	0
Bit	ERROR					DRDY	AMATCH	PREC
Access	R/W					R/W	R/W	R/W
Reset	0					0	0	0

### Bit 7 – ERROR: Error

This bit is set when any error is detected. Errors that will set this flag have corresponding status flags in the STATUS register. The corresponding bits in STATUS are SEXTTOUT, LOWTOUT, COLL, and BUSERR.

Writing '0' to this bit has no effect.

Writing '1' to this bit will clear the flag.

### Bit 2 – DRDY: Data Ready

This flag is set when a I<sup>2</sup>C slave byte transmission is successfully completed.

The flag is cleared by hardware when either:

- Writing to the DATA register.
- Reading the DATA register with smart mode enabled.
- Writing a valid command to the CMD register.

Writing '0' to this bit has no effect.

Writing '1' to this bit will clear the Data Ready interrupt flag.

### Bit 1 – AMATCH: Address Match

This flag is set when the I<sup>2</sup>C slave address match logic detects that a valid address has been received.

The flag is cleared by hardware when CTRL.CMD is written.

Writing '0' to this bit has no effect.

Writing '1' to this bit will clear the Address Match interrupt flag. When cleared, an ACK/NACK will be sent according to CTRLB.ACKACT.

### Bit 0 – PREC: Stop Received

This flag is set when a stop condition is detected for a transaction being processed. A stop condition detected between a bus master and another slave will not set this flag, unless the PMBus Group Command is enabled in the Control B register (CTRLB.GCMD=1).

This flag is cleared by hardware after a command is issued on the next address match.

Writing '0' to this bit has no effect.

Writing '1' to this bit will clear the Stop Received interrupt flag.

## 34.8.6 Status

**Name:** STATUS  
**Offset:** 0x1A [ID-00001bb3]  
**Reset:** 0x0000  
**Property:** -

	Bit	15	14	13	12	11	10	9	8
							LENERR	SEXTTOUT	
Access							R/W	R/W	
Reset							0	0	
	Bit	7	6	5	4	3	2	1	0
		CLKHOLD	LOWTOUT		SR	DIR	RXNACK	COLL	BUSERR
Access		R	R/W		R	R	R	R/W	R/W
Reset		0	0		0	0	0	0	0

**Bit 10 – LENERR: Transaction Length Error**

This bit is set when the length counter is enabled (LENGTH.LENEN) and a STOP or repeated START is received before or after the length in LENGTH.LEN is reached.

This bit is cleared automatically when responding to a new start condition with ACK or NACK (CTRLB.CMD=0x3) or when INTFLAG.AMATCH is cleared.

Writing a '0' to this bit has no effect.

Writing a '1' to this bit will clear the status.

**Bit 10 – HS: High-speed**

This bit is set if the slave detects a START followed by a Master Code transmission.

Writing a '0' to this bit has no effect.

Writing a '1' to this bit will clear the status. However, this flag is automatically cleared when a STOP is received.

**Bit 9 – SEXTTOUT: Slave SCL Low Extend Time-Out**

This bit is set if a slave SCL low extend time-out occurs.

This bit is cleared automatically if responding to a new start condition with ACK or NACK (write 3 to CTRLB.CMD) or when INTFLAG.AMATCH is cleared.

Writing a '0' to this bit has no effect.

Writing a '1' to this bit will clear the status.

Value	Description
0	No SCL low extend time-out has occurred.
1	SCL low extend time-out has occurred.

**Bit 7 – CLKHOLD: Clock Hold**

The slave Clock Hold bit (STATUS.CLKHOLD) is set when the slave is holding the SCL line low, stretching the I2C clock. Software should consider this bit a read-only status flag that is set when INTFLAG.DRDY or INTFLAG.AMATCH is set.

This bit is automatically cleared when the corresponding interrupt is also cleared.

**Bit 6 – LOWTOUT: SCL Low Time-out**

This bit is set if an SCL low time-out occurs.

This bit is cleared automatically if responding to a new start condition with ACK or NACK (write 3 to CTRLB.CMD) or when INTFLAG.AMATCH is cleared.

Writing a '0' to this bit has no effect.

Writing a '1' to this bit will clear the status.

Value	Description
0	No SCL low time-out has occurred.
1	SCL low time-out has occurred.

**Bit 4 – SR: Repeated Start**

When INTFLAG.AMATCH is raised due to an address match, SR indicates a repeated start or start condition.

This flag is only valid while the INTFLAG.AMATCH flag is one.

Value	Description
0	Start condition on last address match
1	Repeated start condition on last address match

**Bit 3 – DIR: Read / Write Direction**

The Read/Write Direction (STATUS.DIR) bit stores the direction of the last address packet received from a master.

Value	Description
0	Master write operation is in progress.
1	Master read operation is in progress.

**Bit 2 – RXNACK: Received Not Acknowledge**

This bit indicates whether the last data packet sent was acknowledged or not.

Value	Description
0	Master responded with ACK.
1	Master responded with NACK.

**Bit 1 – COLL: Transmit Collision**

If set, the I2C slave was not able to transmit a high data or NACK bit, the I2C slave will immediately release the SDA and SCL lines and wait for the next packet addressed to it.

This flag is intended for the SMBus address resolution protocol (ARP). A detected collision in non-ARP situations indicates that there has been a protocol violation, and should be treated as a bus error.

Note that this status will not trigger any interrupt, and should be checked by software to verify that the data were sent correctly. This bit is cleared automatically if responding to an address match with an ACK or a NACK (writing 0x3 to CTRLB.CMD), or INTFLAG.AMATCH is cleared.

Writing a '0' to this bit has no effect.

Writing a '1' to this bit will clear the status.

Value	Description
0	No collision detected on last data byte sent.
1	Collision detected on last data byte sent.

## Bit 0 – BUSERR: Bus Error

The Bus Error bit (STATUS.BUSERR) indicates that an illegal bus condition has occurred on the bus, regardless of bus ownership. An illegal bus condition is detected if a protocol violating start, repeated start or stop is detected on the I2C bus lines. A start condition directly followed by a stop condition is one example of a protocol violation. If a time-out occurs during a frame, this is also considered a protocol violation, and will set STATUS.BUSERR.

This bit is cleared automatically if responding to an address match with an ACK or a NACK (writing 0x3 to CTRLB.COMD) or INTFLAG.AMATCH is cleared.

Writing a '1' to this bit will clear the status.

Writing a '0' to this bit has no effect.

Value	Description
0	No bus error detected.
1	Bus error detected.

### 34.8.7 Synchronization Busy

**Name:** SYNCBUSY  
**Offset:** 0x1C [ID-00001bb3]  
**Reset:** 0x00000000



## Bit 1 – ENABLE: SERCOM Enable Synchronization Busy

Enabling and disabling the SERCOM (CTRLA.ENABLE) requires synchronization. When written, the SYNCBUSY.ENABLE bit will be set until synchronization is complete.

Writes to any register (except for CTRLA.SWRST) while enable synchronization is on-going will be discarded and an APB error will be generated.

Value	Description
0	Enable synchronization is not busy.
1	Enable synchronization is busy.

**Bit 0 – SWRST: Software Reset Synchronization Busy**

Resetting the SERCOM (CTRLA.SWRST) requires synchronization. When written, the SYNCBUSY.SWRST bit will be set until synchronization is complete.

Writes to any register while synchronization is on-going will be discarded and an APB error will be generated.

Value	Description
0	SWRST synchronization is not busy.
1	SWRST synchronization is busy.

### 34.8.8 Address

**Name:** ADDR

**Offset:** 0x24 [ID-00001bb3]

**Reset:** 0x00000000

**Property:** PAC Write-Protection, Enable-Protected

Bit	31	30	29	28	27	26	25	24	
	ADDRMASK[9:7]								
Access						R/W	R/W	R/W	
Reset						0	0	0	
Bit	23	22	21	20	19	18	17	16	
	ADDRMASK[6:0]								
Access	R/W	R/W	R/W	R/W	R/W	R/W	R/W		
Reset	0	0	0	0	0	0	0		
Bit	15	14	13	12	11	10	9	8	
	TENBITEN					ADDR[9:7]			
Access	R/W					R/W	R/W	R/W	
Reset	0					0	0	0	
Bit	7	6	5	4	3	2	1	0	
	ADDR[6:0]							GENCEN	
Access	R/W	R/W	R/W	R/W	R/W	R/W	R/W	R/W	
Reset	0	0	0	0	0	0	0	0	

**Bits 26:17 – ADDRMASK[9:0]: Address Mask**

These bits act as a second address match register, an address mask register or the lower limit of an address range, depending on the CTRLB.AMODE setting.

**Bit 15 – TENBITEN: Ten Bit Addressing Enable**

Value	Description
0	10-bit address recognition disabled.
1	10-bit address recognition enabled.

## Bits 10:1 – ADDR[9:0]: Address

These bits contain the I<sup>2</sup>C slave address used by the slave address match logic to determine if a master has addressed the slave.

When using 7-bit addressing, the slave address is represented by ADDR[6:0].

When using 10-bit addressing (ADDR.TENBITEN=1), the slave address is represented by ADDR[9:0]

When the address match logic detects a match, INTFLAG.AMATCH is set and STATUS.DIR is updated to indicate whether it is a read or a write transaction.

## Bit 0 – GENCEN: General Call Address Enable

A general call address is an address consisting of all-zeroes, including the direction bit (master write).

Value	Description
0	General call address recognition disabled.
1	General call address recognition enabled.

### 34.8.9 Data

**Name:** DATA

**Offset:** 0x28 [ID-00001bb3]

**Reset:** 0x0000

**Property:** Write-Synchronized, Read-Synchronized

	Bit	15	14	13	12	11	10	9	8
		[Greyed out bits 15:8]							
Access									
Reset									
	Bit	7	6	5	4	3	2	1	0
		DATA[7:0]							
Access		R/W	R/W	R/W	R/W	R/W	R/W	R/W	R/W
Reset		0	0	0	0	0	0	0	0

## Bits 7:0 – DATA[7:0]: Data

The slave data register I/O location (DATA.DATA) provides access to the master transmit and receive data buffers. Reading valid data or writing data to be transmitted can be successfully done only when SCL is held low by the slave (STATUS.CLKHOLD is set). An exception occurs when reading the last data byte after the stop condition has been received.

Accessing DATA.DATA auto-triggers I<sup>2</sup>C bus operations. The operation performed depends on the state of CTRLB.ACKACT, CTRLB.SMEN and the type of access (read/write).

Writing or reading DATA.DATA when not in smart mode does not require synchronization.

## 34.9 Register Summary - I2C Master

Offset	Name	Bit Pos.								
0x00	CTRLA	7:0	RUNSTDBY			MODE[2:0]		ENABLE	SWRST	
0x01		15:8								
0x02		23:16	SEXTTOEN	MEXTTOEN	SDAHOLD[1:0]				PINOUT	
0x03		31:24		LOWTOUT	INACTOUT[1:0]		SCLSM		SPEED[1:0]	
0x04	CTRLB	7:0								
0x05		15:8					QCEN	SMEN		
0x06		23:16					ACKACT	CMD[1:0]		
0x07		31:24								
0x08 ... 0x0B	Reserved									
0x0C	BAUD	7:0	BAUD[7:0]							
0x0D		15:8	BAUDLOW[7:0]							
0x0E		23:16	HSBAUD[7:0]							
0x0F		31:24	HSBAUDLOW[7:0]							
0x10 ... 0x13	Reserved									
0x14	INTENCLR	7:0	ERROR					SB	MB	
0x15	Reserved									
0x16	INTENSET	7:0	ERROR					SB	MB	
0x17	Reserved									
0x18	INTFLAG	7:0	ERROR					SB	MB	
0x18	DATA	7:0	DATA[7:0]							
0x19		15:8								
0x1A	STATUS	7:0	CLKHOLD	LOWTOUT	BUSSTATE[1:0]			RXNACK	ARBLOST	BUSERR
0x1B		15:8						LENERR	SEXTTOUT	MEXTTOUT
0x1C	SYNDBUSY	7:0						SYSOP	ENABLE	SWRST
0x1D		15:8								
0x1E		23:16								
0x1F		31:24								
0x21 ... 0x23	Reserved									
0x24	ADDR	7:0								
0x25		15:8	TENBITEN	HS	LENEN			ADDR[2:0]		
0x26		23:16	LEN[7:0]							
0x27		31:24								
0x28 ... 0x2F	Reserved									
0x30	DBGCTRL	7:0							DBGSTOP	



## 34.10 Register Description - I<sup>2</sup>C Master

Registers can be 8, 16, or 32 bits wide. Atomic 8-, 16- and 32-bit accesses are supported. In addition, the 8-bit quarters and 16-bit halves of a 32-bit register, and the 8-bit halves of a 16-bit register can be accessed directly.

Some registers are optionally write-protected by the Peripheral Access Controller (PAC). Optional PAC write-protection is denoted by the "PAC Write-Protection" property in each individual register description. For details, refer to [Register Access Protection](#).

Some registers are synchronized when read and/or written. Synchronization is denoted by the "Write-Synchronized" or the "Read-Synchronized" property in each individual register description. For details, refer to [Synchronization](#).

Some registers are enable-protected, meaning they can only be written when the peripheral is disabled. Enable-protection is denoted by the "Enable-Protected" property in each individual register description.

### 34.10.1 Control A

**Name:** CTRLA

**Offset:** 0x00 [ID-00001bb3]

**Reset:** 0x00000000

**Property:** PAC Write-Protection, Enable-Protected, Write-Synchronized

Bit	31	30	29	28	27	26	25	24
		LOWTOUT	INACTOUT[1:0]		SCLSM		SPEED[1:0]	
Access		R/W	R/W	R/W	R/W		R/W	R/W
Reset		0	0	0	0		0	0
Bit	23	22	21	20	19	18	17	16
	SEXTTOEN	MEXTTOEN	SDAHOLD[1:0]					PINOUT
Access	R/W	R/W	R/W	R/W				R/W
Reset	0	0	0	0				0
Bit	15	14	13	12	11	10	9	8
Access								
Reset								
Bit	7	6	5	4	3	2	1	0
	RUNSTDBY			MODE[2:0]			ENABLE	SWRST
Access	R/W			R/W	R/W	R/W	R/W	R/W
Reset	0			0	0	0	0	0

#### Bit 30 – LOWTOUT: SCL Low Time-Out

This bit enables the SCL low time-out. If SCL is held low for 25ms-35ms, the master will release its clock hold, if enabled, and complete the current transaction. A stop condition will automatically be transmitted.

INTFLAG.SB or INTFLAG.MB will be set as normal, but the clock hold will be released. The STATUS.LOWTOUT and STATUS.BUSERR status bits will be set.

This bit is not synchronized.

Value	Description
0	Time-out disabled.
1	Time-out enabled.

**Bits 29:28 – INACTOUT[1:0]: Inactive Time-Out**

If the inactive bus time-out is enabled and the bus is inactive for longer than the time-out setting, the bus state logic will be set to idle. An inactive bus arise when either an I<sup>2</sup>C master or slave is holding the SCL low.

Enabling this option is necessary for SMBus compatibility, but can also be used in a non-SMBus set-up.

Calculated time-out periods are based on a 100kHz baud rate.

These bits are not synchronized.

Value	Name	Description
0x0	DIS	Disabled
0x1	55US	5-6 SCL cycle time-out (50-60μs)
0x2	105US	10-11 SCL cycle time-out (100-110μs)
0x3	205US	20-21 SCL cycle time-out (200-210μs)

**Bit 27 – SCLSM: SCL Clock Stretch Mode**

This bit controls when SCL will be stretched for software interaction.

This bit is not synchronized.

Value	Description
0	SCL stretch according to <a href="#">Figure 34-4</a> .
1	SCL stretch only after ACK bit, <a href="#">Figure 34-5</a> .

**Bits 25:24 – SPEED[1:0]: Transfer Speed**

These bits define bus speed.

These bits are not synchronized.

Value	Description
0x0	Standard-mode (Sm) up to 100 kHz and Fast-mode (Fm) up to 400 kHz
0x1	Fast-mode Plus (Fm+) up to 1 MHz
0x2	High-speed mode (Hs-mode) up to 3.4 MHz
0x3	Reserved

**Bit 23 – SEXTTOEN: Slave SCL Low Extend Time-Out**

This bit enables the slave SCL low extend time-out. If SCL is cumulatively held low for greater than 25ms from the initial START to a STOP, the master will release its clock hold if enabled, and complete the current transaction. A STOP will automatically be transmitted.

SB or MB will be set as normal, but CLKHOLD will be release. The MEXTTOUT and BUSERR status bits will be set.

This bit is not synchronized.

Value	Description
0	Time-out disabled
1	Time-out enabled

## Bit 22 – MEXTTOEN: Master SCL Low Extend Time-Out

This bit enables the master SCL low extend time-out. If SCL is cumulatively held low for greater than 10ms from START-to-ACK, ACK-to-ACK, or ACK-to-STOP the master will release its clock hold if enabled, and complete the current transaction. A STOP will automatically be transmitted.

SB or MB will be set as normal, but CLKHOLD will be released. The MEXTTOUT and BUSERR status bits will be set.

This bit is not synchronized.

Value	Description
0	Time-out disabled
1	Time-out enabled

## Bits 21:20 – SDAHOLD[1:0]: SDA Hold Time

These bits define the SDA hold time with respect to the negative edge of SCL.

These bits are not synchronized.

Value	Name	Description
0x0	DIS	Disabled
0x1	75NS	50-100ns hold time
0x2	450NS	300-600ns hold time
0x3	600NS	400-800ns hold time

## Bit 16 – PINOUT: Pin Usage

This bit set the pin usage to either two- or four-wire operation:

This bit is not synchronized.

Value	Description
0	4-wire operation disabled.
1	4-wire operation enabled.

## Bit 7 – RUNSTDBY: Run in Standby

This bit defines the functionality in standby sleep mode.

This bit is not synchronized.

Value	Description
0	GCLK_SERCOMx_CORE is disabled and the I <sup>2</sup> C master will not operate in standby sleep mode.
1	GCLK_SERCOMx_CORE is enabled in all sleep modes.

## Bits 4:2 – MODE[2:0]: Operating Mode

These bits must be written to 0x5 to select the I<sup>2</sup>C master serial communication interface of the SERCOM.

These bits are not synchronized.

## Bit 1 – ENABLE: Enable

Due to synchronization, there is delay from writing CTRLA.ENABLE until the peripheral is enabled/disabled. The value written to CTRLA.ENABLE will read back immediately and the Synchronization Enable Busy bit in the Synchronization Busy register (SYNCBUSY.ENABLE) will be set. SYNCBUSY.ENABLE will be cleared when the operation is complete.

This bit is not enable-protected.

Value	Description
0	The peripheral is disabled or being disabled.
1	The peripheral is enabled.

### Bit 0 – SWRST: Software Reset

Writing '0' to this bit has no effect.

Writing '1' to this bit resets all registers in the SERCOM, except DBGCTRL, to their initial state, and the SERCOM will be disabled.

Writing '1' to CTRLA.SWRST will always take precedence, meaning that all other writes in the same write-operation will be discarded. Any register write access during the ongoing reset will result in an APB error. Reading any register will return the reset value of the register.

Due to synchronization there is a delay from writing CTRLA.SWRST until the reset is complete. CTRLA.SWRST and SYNCBUSY.SWRST will both be cleared when the reset is complete.

This bit is not enable-protected.

Value	Description
0	There is no reset operation ongoing.
1	The reset operation is ongoing.

## 34.10.2 Control B

**Name:** CTRLB

**Offset:** 0x04 [ID-00001bb3]

**Reset:** 0x00000000

**Property:** PAC Write-Protection, Enable-Protected, Write-Synchronized

Bit	31	30	29	28	27	26	25	24
Access								
Reset								
Bit	23	22	21	20	19	18	17	16
						ACKACT	CMD[1:0]	
Access						R/W	R/W	R/W
Reset						0	0	0
Bit	15	14	13	12	11	10	9	8
							QCEN	SMEN
Access							R	R/W
Reset							0	0
Bit	7	6	5	4	3	2	1	0
Access								
Reset								

**Bit 18 – ACKACT: Acknowledge Action**

This bit defines the I<sup>2</sup>C master's acknowledge behavior after a data byte is received from the I<sup>2</sup>C slave. The acknowledge action is executed when a command is written to CTRLB.CMD, or if smart mode is enabled (CTRLB.SMEN is written to one), when DATA.DATA is read.

This bit is not enable-protected.

This bit is not write-synchronized.

Value	Description
0	Send ACK.
1	Send NACK.

**Bits 17:16 – CMD[1:0]: Command**

Writing these bits triggers a master operation as described below. The CMD bits are strobe bits, and always read as zero. The acknowledge action is only valid in master read mode. In master write mode, a command will only result in a repeated start or stop condition. The CTRLB.ACKACT bit and the CMD bits can be written at the same time, and then the acknowledge action will be updated before the command is triggered.

Commands can only be issued when either the Slave on Bus interrupt flag (INTFLAG.SB) or Master on Bus interrupt flag (INTFLAG.MB) is '1'.

If CMD 0x1 is issued, a repeated start will be issued followed by the transmission of the current address in ADDR.ADDR. If another address is desired, ADDR.ADDR must be written instead of the CMD bits. This will trigger a repeated start followed by transmission of the new address.

Issuing a command will set the System Operation bit in the Synchronization Busy register (SYNCSBUSY.SYSOP).

**Table 34-4. Command Description**

CMD[1:0]	Direction	Action
0x0	X	(No action)
0x1	X	Execute acknowledge action succeeded by repeated Start
0x2	0 (Write)	No operation
	1 (Read)	Execute acknowledge action succeeded by a byte read operation
0x3	X	Execute acknowledge action succeeded by issuing a stop condition

These bits are not enable-protected.

**Bit 9 – QCEN: Quick Command Enable**

This bit is not write-synchronized.

Value	Description
0	Quick Command is disabled.
1	Quick Command is enabled.

**Bit 8 – SMEN: Smart Mode Enable**

When smart mode is enabled, acknowledge action is sent when DATA.DATA is read.

This bit is not write-synchronized.

Value	Description
0	Smart mode is disabled.
1	Smart mode is enabled.

**34.10.3 Baud Rate**

**Name:** BAUD

**Offset:** 0x0C [ID-00001bb3]

**Reset:** 0x0000

**Property:** PAC Write-Protection, Enable-Protected

Bit	31	30	29	28	27	26	25	24
HSBAUDLOW[7:0]								
Access	R/W	R/W	R/W	R/W	R/W	R/W	R/W	R/W
Reset	0	0	0	0	0	0	0	0
Bit	23	22	21	20	19	18	17	16
HSBAUD[7:0]								
Access	R/W	R/W	R/W	R/W	R/W	R/W	R/W	R/W
Reset	0	0	0	0	0	0	0	0
Bit	15	14	13	12	11	10	9	8
BAUDLOW[7:0]								
Access	R/W	R/W	R/W	R/W	R/W	R/W	R/W	R/W
Reset	0	0	0	0	0	0	0	0
Bit	7	6	5	4	3	2	1	0
BAUD[7:0]								
Access	R/W	R/W	R/W	R/W	R/W	R/W	R/W	R/W
Reset	0	0	0	0	0	0	0	0

**Bits 31:24 – HSBAUDLOW[7:0]: High Speed Master Baud Rate Low**

HSBAUDLOW non-zero: HSBAUDLOW indicates the SCL low time in High-speed mode according to

$$HSBAUDLOW = f_{GCLK} \cdot T_{LOW} - 1$$

HSBAUDLOW equal to zero: The HSBAUD register is used to time  $T_{LOW}$ ,  $T_{HIGH}$ ,  $T_{SU;STO}$ ,  $T_{HD;STA}$  and  $T_{SU;STA}$ .  $T_{BUF}$  is timed by the BAUD register.

**Bits 23:16 – HSBAUD[7:0]: High Speed Master Baud Rate**

This bit field indicates the SCL high time in High-speed mode according to the following formula. When HSBAUDLOW is zero,  $T_{LOW}$ ,  $T_{HIGH}$ ,  $T_{SU;STO}$ ,  $T_{HD;STA}$  and  $T_{SU;STA}$  are derived using this formula.  $T_{BUF}$  is timed by the BAUD register.

$$HSBAUD = f_{GCLK} \cdot T_{HIGH} - 1$$

**Bits 15:8 – BAUDLOW[7:0]: Master Baud Rate Low**

If this bit field is non-zero, the SCL low time will be described by the value written.

For more information on how to calculate the frequency, see SERCOM [Clock Generation – Baud-Rate Generator](#).

**Bits 7:0 – BAUD[7:0]: Master Baud Rate**

This bit field is used to derive the SCL high time if BAUD.BAUDLOW is non-zero. If BAUD.BAUDLOW is zero, BAUD will be used to generate both high and low periods of the SCL.

For more information on how to calculate the frequency, see SERCOM [Clock Generation – Baud-Rate Generator](#).

**34.10.4 Interrupt Enable Clear**

This register allows the user to disable an interrupt without doing a read-modify-write operation. Changes in this register will also be reflected in the Interrupt Enable Set register (INTENSET).

**Name:** INTENCLR  
**Offset:** 0x14 [ID-00001bb3]  
**Reset:** 0x00  
**Property:** PAC Write-Protection

Bit	7	6	5	4	3	2	1	0
	ERROR						SB	MB
Access	R/W						R/W	R/W
Reset	0						0	0

### Bit 7 – ERROR: Error Interrupt Enable

Writing '0' to this bit has no effect.

Writing '1' to this bit will clear the Error Interrupt Enable bit, which disables the Error interrupt.

Value	Description
0	Error interrupt is disabled.
1	Error interrupt is enabled.

### Bit 1 – SB: Slave on Bus Interrupt Enable

Writing '0' to this bit has no effect.

Writing '1' to this bit will clear the Slave on Bus Interrupt Enable bit, which disables the Slave on Bus interrupt.

Value	Description
0	The Slave on Bus interrupt is disabled.
1	The Slave on Bus interrupt is enabled.

### Bit 0 – MB: Master on Bus Interrupt Enable

Writing '0' to this bit has no effect.

Writing '1' to this bit will clear the Master on Bus Interrupt Enable bit, which disables the Master on Bus interrupt.

Value	Description
0	The Master on Bus interrupt is disabled.
1	The Master on Bus interrupt is enabled.

## 34.10.5 Interrupt Enable Clear

This register allows the user to enable an interrupt without doing a read-modify-write operation. Changes in this register will also be reflected in the Interrupt Enable Clear register (INTENCLR).

**Name:** INTENSET  
**Offset:** 0x16 [ID-00001bb3]  
**Reset:** 0x00  
**Property:** PAC Write-Protection



Bit	7	6	5	4	3	2	1	0
	ERROR						SB	MB
Access	R/W						R/W	R/W
Reset	0						0	0

**Bit 7 – ERROR: Error Interrupt Enable**

Writing '0' to this bit has no effect.

Writing '1' to this bit will set the Error Interrupt Enable bit, which enables the Error interrupt.

Value	Description
0	Error interrupt is disabled.
1	Error interrupt is enabled.

**Bit 1 – SB: Slave on Bus Interrupt Enable**

Writing '0' to this bit has no effect.

Writing '1' to this bit will set the Slave on Bus Interrupt Enable bit, which enables the Slave on Bus interrupt.

Value	Description
0	The Slave on Bus interrupt is disabled.
1	The Slave on Bus interrupt is enabled.

**Bit 0 – MB: Master on Bus Interrupt Enable**

Writing '0' to this bit has no effect.

Writing '1' to this bit will set the Master on Bus Interrupt Enable bit, which enables the Master on Bus interrupt.

Value	Description
0	The Master on Bus interrupt is disabled.
1	The Master on Bus interrupt is enabled.

### 34.10.6 Interrupt Flag Status and Clear

**Name:** INTFLAG  
**Offset:** 0x18 [ID-00001bb3]  
**Reset:** 0x00  
**Property:** -

Bit	7	6	5	4	3	2	1	0
	ERROR						SB	MB
Access	R/W						R/W	R/W
Reset	0						0	0

**Bit 7 – ERROR: Error**

This flag is cleared by writing '1' to it.

This bit is set when any error is detected. Errors that will set this flag have corresponding status bits in the STATUS register. These status bits are LENERR, SEXTTOUT, MEXTTOUT, LOWTOUT, ARBLOST, and BUSERR.

Writing '0' to this bit has no effect.

Writing '1' to this bit will clear the flag.

## **Bit 1 – SB: Slave on Bus**

The Slave on Bus flag (SB) is set when a byte is successfully received in master read mode, i.e., no arbitration lost or bus error occurred during the operation. When this flag is set, the master forces the SCL line low, stretching the I<sup>2</sup>C clock period. The SCL line will be released and SB will be cleared on one of the following actions:

- Writing to ADDR.ADDR
- Writing to DATA.DATA
- Reading DATA.DATA when smart mode is enabled (CTRLB.SMEN)
- Writing a valid command to CTRLB.CMD

Writing '1' to this bit location will clear the SB flag. The transaction will not continue or be terminated until one of the above actions is performed.

Writing '0' to this bit has no effect.

## **Bit 0 – MB: Master on Bus**

This flag is set when a byte is transmitted in master write mode. The flag is set regardless of the occurrence of a bus error or an arbitration lost condition. MB is also set when arbitration is lost during sending of NACK in master read mode, or when issuing a start condition if the bus state is unknown. When this flag is set and arbitration is not lost, the master forces the SCL line low, stretching the I<sup>2</sup>C clock period. The SCL line will be released and MB will be cleared on one of the following actions:

- Writing to ADDR.ADDR
- Writing to DATA.DATA
- Reading DATA.DATA when smart mode is enabled (CTRLB.SMEN)
- Writing a valid command to CTRLB.CMD

Writing '1' to this bit location will clear the MB flag. The transaction will not continue or be terminated until one of the above actions is performed.

Writing '0' to this bit has no effect.

### **34.10.7 Status**

**Name:** STATUS

**Offset:** 0x1A [ID-00001bb3]

**Reset:** 0x0000

**Property:** Write-Synchronized

Bit	15	14	13	12	11	10	9	8
						LENERR	SEXTTOUT	MEXTTOUT
Access						R/W	R/W	R/W
Reset						0	0	0
Bit	7	6	5	4	3	2	1	0
	CLKHOLD	LOWTOUT	BUSSTATE[1:0]			RXNACK	ARBLOST	BUSERR
Access	R	R/W	R	R		R	R/W	R/W
Reset	0	0	0	0		0	0	0

**Bit 10 – LENERR: Transaction Length Error**

This bit is set when automatic length is used for a DMA transaction and the slave sends a NACK before ADDR.LEN bytes have been written by the master.

Writing '1' to this bit location will clear STATUS.LENERR. This flag is automatically cleared when writing to the ADDR register.

Writing '0' to this bit has no effect.

This bit is not write-synchronized.

**Bit 9 – SEXTTOUT: Slave SCL Low Extend Time-Out**

This bit is set if a slave SCL low extend time-out occurs.

This bit is automatically cleared when writing to the ADDR register.

Writing '1' to this bit location will clear SEXTTOUT. Normal use of the I<sup>2</sup>C interface does not require the SEXTTOUT flag to be cleared by this method.

Writing '0' to this bit has no effect.

This bit is not write-synchronized.

**Bit 8 – MEXTTOUT: Master SCL Low Extend Time-Out**

This bit is set if a master SCL low time-out occurs.

Writing '1' to this bit location will clear STATUS.MEXTTOUT. This flag is automatically cleared when writing to the ADDR register.

Writing '0' to this bit has no effect.

This bit is not write-synchronized.

**Bit 7 – CLKHOLD: Clock Hold**

This bit is set when the master is holding the SCL line low, stretching the I<sup>2</sup>C clock. Software should consider this bit when INTFLAG.SB or INTFLAG.MB is set.

This bit is cleared when the corresponding interrupt flag is cleared and the next operation is given.

Writing '0' to this bit has no effect.

Writing '1' to this bit has no effect.

This bit is not write-synchronized.

**Bit 6 – LOWTOUT: SCL Low Time-Out**

This bit is set if an SCL low time-out occurs.

Writing '1' to this bit location will clear this bit. This flag is automatically cleared when writing to the ADDR register.

Writing '0' to this bit has no effect.

This bit is not write-synchronized.

### Bits 5:4 – BUSSTATE[1:0]: Bus State

These bits indicate the current I<sup>2</sup>C bus state.

When in UNKNOWN state, writing 0x1 to BUSSTATE forces the bus state into the IDLE state. The bus state cannot be forced into any other state.

Writing BUSSTATE to idle will set SYNCBUSY.SYSOP.

Value	Name	Description
0x0	UNKNOWN	The bus state is unknown to the I <sup>2</sup> C master and will wait for a stop condition to be detected or wait to be forced into an idle state by software
0x1	IDLE	The bus state is waiting for a transaction to be initialized
0x2	OWNER	The I <sup>2</sup> C master is the current owner of the bus
0x3	BUSY	Some other I <sup>2</sup> C master owns the bus

### Bit 2 – RXNACK: Received Not Acknowledge

This bit indicates whether the last address or data packet sent was acknowledged or not.

Writing '0' to this bit has no effect.

Writing '1' to this bit has no effect.

This bit is not write-synchronized.

Value	Description
0	Slave responded with ACK.
1	Slave responded with NACK.

### Bit 1 – ARBLOST: Arbitration Lost

This bit is set if arbitration is lost while transmitting a high data bit or a NACK bit, or while issuing a start or repeated start condition on the bus. The Master on Bus interrupt flag (INTFLAG.MB) will be set when STATUS.ARBLOST is set.

Writing the ADDR.ADDR register will automatically clear STATUS.ARBLOST.

Writing '0' to this bit has no effect.

Writing '1' to this bit will clear it.

This bit is not write-synchronized.

### Bit 0 – BUSERR: Bus Error

This bit indicates that an illegal bus condition has occurred on the bus, regardless of bus ownership. An illegal bus condition is detected if a protocol violating start, repeated start or stop is detected on the I<sup>2</sup>C bus lines. A start condition directly followed by a stop condition is one example of a protocol violation. If a time-out occurs during a frame, this is also considered a protocol violation, and will set BUSERR.

If the I<sup>2</sup>C master is the bus owner at the time a bus error occurs, STATUS.ARBLOST and INTFLAG.MB will be set in addition to BUSERR.

Writing the ADDR.ADDR register will automatically clear the BUSERR flag.

Writing '0' to this bit has no effect.

Writing '1' to this bit will clear it.

This bit is not write-synchronized.

### 34.10.8 Synchronization Busy

**Name:** SYNCBUSY  
**Offset:** 0x1C [ID-00001bb3]  
**Reset:** 0x00000000

Bit	31	30	29	28	27	26	25	24
	[Greyed out bits 31-24]							
Access								
Reset								
Bit	23	22	21	20	19	18	17	16
	[Greyed out bits 23-16]							
Access								
Reset								
Bit	15	14	13	12	11	10	9	8
	[Greyed out bits 15-8]							
Access								
Reset								
Bit	7	6	5	4	3	2	1	0
	[Greyed out bits 7-3]					SYSOP	ENABLE	SWRST
Access						R	R	R
Reset						0	0	0

#### Bit 2 – SYSOP: System Operation Synchronization Busy

Writing CTRLB.CMD, STATUS.BUSSTATE, ADDR, or DATA when the SERCOM is enabled requires synchronization. When written, the SYNCBUSY.SYSOP bit will be set until synchronization is complete.

Value	Description
0	System operation synchronization is not busy.
1	System operation synchronization is busy.

#### Bit 1 – ENABLE: SERCOM Enable Synchronization Busy

Enabling and disabling the SERCOM (CTRLA.ENABLE) requires synchronization. When written, the SYNCBUSY.ENABLE bit will be set until synchronization is complete.

Writes to any register (except for CTRLA.SWRST) while enable synchronization is on-going will be discarded and an APB error will be generated.

Value	Description
0	Enable synchronization is not busy.
1	Enable synchronization is busy.

## Bit 0 – SWRST: Software Reset Synchronization Busy

Resetting the SERCOM (CTRLA.SWRST) requires synchronization. When written, the SYNCBUSY.SWRST bit will be set until synchronization is complete.

Writes to any register while synchronization is on-going will be discarded and an APB error will be generated.

Value	Description
0	SWRST synchronization is not busy.
1	SWRST synchronization is busy.

### 34.10.9 Address

**Name:** ADDR  
**Offset:** 0x24 [ID-00001bb3]  
**Reset:** 0x0000  
**Property:** Write-Synchronized

Bit	31	30	29	28	27	26	25	24
Access								
Reset								
Bit	23	22	21	20	19	18	17	16
Access	LEN[7:0]							
Reset	0							
Bit	15	14	13	12	11	10	9	8
Access	TENBITEN	HS	LENEN			ADDR[2:0]		
Reset	0	0	0			0	0	0
Bit	7	6	5	4	3	2	1	0
Access								
Reset								

#### Bits 23:16 – LEN[7:0]: Transaction Length

These bits define the transaction length of a DMA transaction from 0 to 255 bytes. The Transfer Length Enable (LENEN) bit must be written to '1' in order to use DMA.

#### Bit 15 – TENBITEN: Ten Bit Addressing Enable

This bit enables 10-bit addressing. This bit can be written simultaneously with ADDR to indicate a 10-bit or 7-bit address transmission.

Value	Description
0	10-bit addressing disabled.
1	10-bit addressing enabled.

## Bit 14 – HS: High Speed

This bit enables High-speed mode for the current transfer from repeated START to STOP. This bit can be written simultaneously with ADDR for a high speed transfer.

Value	Description
0	High-speed transfer disabled.
1	High-speed transfer enabled.

## Bit 13 – LENEN: Transfer Length Enable

Value	Description
0	Automatic transfer length disabled.
1	Automatic transfer length enabled.

## Bits 10:8 – ADDR[2:0]: Address

When ADDR is written, the consecutive operation will depend on the bus state:

UNKNOWN: INTFLAG.MB and STATUS.BUSERR are set, and the operation is terminated.

BUSY: The I<sup>2</sup>C master will await further operation until the bus becomes IDLE.

IDLE: The I<sup>2</sup>C master will issue a start condition followed by the address written in ADDR. If the address is acknowledged, SCL is forced and held low, and STATUS.CLKHOLD and INTFLAG.MB are set.

OWNER: A repeated start sequence will be performed. If the previous transaction was a read, the acknowledge action is sent before the repeated start bus condition is issued on the bus. Writing ADDR to issue a repeated start is performed while INTFLAG.MB or INTFLAG.SB is set.

STATUS.BUSERR, STATUS.ARBLOST, INTFLAG.MB and INTFLAG.SB will be cleared when ADDR is written.

The ADDR register can be read at any time without interfering with ongoing bus activity, as a read access does not trigger the master logic to perform any bus protocol related operations.

The I<sup>2</sup>C master control logic uses bit 0 of ADDR as the bus protocol's read/write flag (R/W); 0 for write and 1 for read.

### 34.10.10 Data

**Name:** DATA

**Offset:** 0x18 [ID-00001bb3]

**Reset:** 0x0000

**Property:** Write-Synchronized, Read-Synchronized

Bit	15	14	13	12	11	10	9	8
Access	[Greyed out]							
Reset	[Greyed out]							
Bit	7	6	5	4	3	2	1	0
Access	DATA[7:0]							
Reset	0	0	0	0	0	0	0	0

**Bits 7:0 – DATA[7:0]: Data**

The master data register I/O location (DATA) provides access to the master transmit and receive data buffers. Reading valid data or writing data to be transmitted can be successfully done only when SCL is held low by the master (STATUS.CLKHOLD is set). An exception is reading the last data byte after the stop condition has been sent.

Accessing DATA.DATA auto-triggers I<sup>2</sup>C bus operations. The operation performed depends on the state of CTRLB.ACKACT, CTRLB.SMEN and the type of access (read/write).

Writing or reading DATA.DATA when not in smart mode does not require synchronization.

**34.10.11 Debug Control**

**Name:** DBGCTRL  
**Offset:** 0x30 [ID-00001bb3]  
**Reset:** 0x00  
**Property:** PAC Write-Protection

Bit	7	6	5	4	3	2	1	0
Access	[Greyed out]							DBGSTOP
Reset	[Greyed out]							0

**Bit 0 – DBGSTOP: Debug Stop Mode**

This bit controls functionality when the CPU is halted by an external debugger.

Value	Description
0	The baud-rate generator continues normal operation when the CPU is halted by an external debugger.
1	The baud-rate generator is halted when the CPU is halted by an external debugger.



## 35. TC – Timer/Counter

### 35.1 Overview

There are up to eight TC peripheral instances.

Each TC consists of a counter, a prescaler, compare/capture channels and control logic. The counter can be set to count events, or clock pulses. The counter, together with the compare/capture channels, can be configured to timestamp input events or IO pin edges, allowing for capturing of frequency and/or pulse width.

A TC can also perform waveform generation, such as frequency generation and pulse-width modulation.

### 35.2 Features

- Selectable configuration
  - 8-, 16- or 32-bit TC operation, with compare/capture channels
- 2 compare/capture channels (CC) with:
  - Double buffered timer period setting (in 8-bit mode only)
  - Double buffered compare channel
- Waveform generation
  - Frequency generation
  - Single-slope pulse-width modulation
- Input capture
  - Event / IO pin edge capture
  - Frequency capture
  - Pulse-width capture
  - Time-stamp capture
  - Minimum and maximum capture
- One input event
- Interrupts/output events on:
  - Counter overflow/underflow
  - Compare match or capture
- Internal prescaler
- DMA support

35.3 Block Diagram

Figure 35-1. Timer/Counter Block Diagram



35.4 Signal Description

Table 35-1. Signal Description for TC.

Signal Name	Type	Description
WO[1:0]	Digital output	Waveform output
	Digital input	Capture input

Refer to *I/O Multiplexing and Considerations* for details on the pin mapping for this peripheral. One signal can be mapped on several pins.

Related Links

### 35.5 Product Dependencies

In order to use this peripheral, other parts of the system must be configured correctly, as described below.

#### 35.5.1 I/O Lines

In order to use the I/O lines of this peripheral, the I/O pins must be configured using the I/O Pin Controller (PORT).

##### Related Links

[PORT: IO Pin Controller](#)

#### 35.5.2 Power Management

This peripheral can continue to operate in any sleep mode where its source clock is running. The interrupts can wake up the device from sleep modes. Events connected to the event system can trigger other operations in the system without exiting sleep modes.

##### Related Links

[PM – Power Manager](#)

#### 35.5.3 Clocks

The TC bus clocks (CLK\_TCx\_APB) can be enabled and disabled in the Main Clock Module. The default state of CLK\_TCx\_APB can be found in the *Peripheral Clock Masking*.

The generic clocks (GCLK\_TCx) are asynchronous to the user interface clock (CLK\_TCx\_APB). Due to this asynchronicity, accessing certain registers will require synchronization between the clock domains. Refer to [Synchronization](#) for further details.

Note that TC0 and TC1 share a peripheral clock channel, as do TC2 and TC3. For this reason they cannot be set to different clock frequencies.

##### Related Links

[Peripheral Clock Masking](#)

#### 35.5.4 DMA

The DMA request lines are connected to the DMA Controller (DMAC). In order to use DMA requests with this peripheral the DMAC must be configured first. Refer to *DMAC – Direct Memory Access Controller* for details.

##### Related Links

[DMAC – Direct Memory Access Controller](#)

#### 35.5.5 Interrupts

The interrupt request line is connected to the Interrupt Controller. In order to use interrupt requests of this peripheral, the Interrupt Controller (NVIC) must be configured first. Refer to *Nested Vector Interrupt Controller* for details.

##### Related Links

[Nested Vector Interrupt Controller](#)

#### 35.5.6 Events

The events of this peripheral are connected to the Event System.

## Related Links

[EVSYS – Event System](#)

### 35.5.7 Debug Operation

When the CPU is halted in debug mode, this peripheral will halt normal operation. This peripheral can be forced to continue operation during debugging - refer to the Debug Control (DBGCTRL) register for details.

### 35.5.8 Register Access Protection

Registers with write-access can be optionally write-protected by the Peripheral Access Controller (PAC), except for the following:

- Interrupt Flag Status and Clear register (INTFLAG)
- Status register (STATUS)
- Count register (COUNT)
- Period and Period Buffer registers (PER, PERBUF)
- Compare/Capture Value registers and Compare/Capture Value Buffer registers (CCx, CCBUFx)

**Note:** Optional write-protection is indicated by the "PAC Write-Protection" property in the register description.

When the CPU is halted in debug mode, all write-protection is automatically disabled. Write-protection does not apply for accesses through an external debugger.

### 35.5.9 Analog Connections

Not applicable.

## 35.6 Functional Description

### 35.6.1 Principle of Operation

The following definitions are used throughout the documentation:

**Table 35-2. Timer/Counter Definitions**

Name	Description
TOP	The counter reaches TOP when it becomes equal to the highest value in the count sequence. The TOP value can be the same as Period (PER) or the Compare Channel 0 (CC0) register value depending on the waveform generator mode in <a href="#">Waveform Output Operations</a> .
ZERO	The counter is ZERO when it contains all zeroes
MAX	The counter reaches MAX when it contains all ones
UPDATE	The timer/counter signals an update when it reaches ZERO or TOP, depending on the direction settings.
Timer	The timer/counter clock control is handled by an internal source
Counter	The clock control is handled externally (e.g. counting external events)
CC	For compare operations, the CC are referred to as “compare channels” For capture operations, the CC are referred to as “capture channels.”

Each TC instance has up to two compare/capture channels (CC0 and CC1).

The counter in the TC can either count events from the Event System, or clock ticks of the GCLK\_TCx clock, which may be divided by the prescaler.

The counter value is passed to the CCx where it can be either compared to user-defined values or captured.

The Counter register (COUNT), compare and capture registers with buffers (CCx and CCBUFx) can be configured as 8-, 16- or 32-bit registers, with according MAX values. Mode settings determine the maximum range of the counter. Each buffer register has a buffer valid (BUFV) flag that indicates when the buffer contains a new value.

In 8-bit mode, Period Value (PER) and Period Buffer Value (PERBUF) registers are also available. The counter range and the operating frequency determine the maximum time resolution achievable with the TC peripheral.

The TC can be set to count up or down. Under normal operation, the counter value is continuously compared to the TOP or ZERO value to determine whether the counter has reached that value. On a comparison match the TC can request DMA transactions, or generate interrupts or events for the Event System.

In compare operation, the counter value is continuously compared to the values in the CCx registers. In case of a match the TC can request DMA transactions, or generate interrupts or events for the Event System. In waveform generator mode, these comparisons are used to set the waveform period or pulse width.

Capture operation can be enabled to perform input signal period and pulse width measurements, or to capture selectable edges from an IO pin or internal event from Event System.

## 35.6.2 Basic Operation

### 35.6.2.1 Initialization

The following registers are enable-protected, meaning that they can only be written when the TC is disabled (CTRLA.ENABLE =0):

- Control A register (CTRLA), except the Enable (ENABLE) and Software Reset (SWRST) bits
- Drive Control register (DRVCTRL)
- Wave register (WAVE)
- Event Control register (EVCTRL)

Enable-protected bits in the CTRLA register can be written at the same time as CTRLA.ENABLE is written to '1', but not at the same time as CTRLA.ENABLE is written to '0'. Enable-protection is denoted by the "Enable-Protected" property in the register description.

Before enabling the TC, the peripheral must be configured by the following steps:

1. Enable the TC bus clock (CLK\_TCx\_APB).
2. Select 8-, 16- or 32-bit counter mode via the TC Mode bit group in the Control A register (CTRLA.MODE). The default mode is 16-bit.
3. Select one wave generation operation in the Waveform Generation Operation bit group in the WAVE register (WAVE.WAVEGEN).
4. If desired, the GCLK\_TCx clock can be prescaled via the Prescaler bit group in the Control A register (CTRLA.PRESCALER).
  - If the prescaler is used, select a prescaler synchronization operation via the Prescaler and Counter Synchronization bit group in the Control A register (CTRLA.PRESYNC).

5. If desired, select one-shot operation by writing a '1' to the One-Shot bit in the Control B Set register (CTRLBSET.ONESHOT).
6. If desired, configure the counting direction 'down' (starting from the TOP value) by writing a '1' to the Counter Direction bit in the Control B register (CTRLBSET.DIR).
7. For capture operation, enable the individual channels to capture in the Capture Channel x Enable bit group in the Control A register (CTRLA.CAPTEN).
8. If desired, enable inversion of the waveform output or IO pin input signal for individual channels via the Invert Enable bit group in the Drive Control register (DRVCTRL.INVEN).

### 35.6.2.2 Enabling, Disabling, and Resetting

The TC is enabled by writing a '1' to the Enable bit in the Control A register (CTRLA.ENABLE). The TC is disabled by writing a zero to CTRLA.ENABLE.

The TC is reset by writing a '1' to the Software Reset bit in the Control A register (CTRLA.SWRST). All registers in the TC, except DBGCTRL, will be reset to their initial state. Refer to the [CTRLA](#) register for details.

The TC should be disabled before the TC is reset in order to avoid undefined behavior.

### 35.6.2.3 Prescaler Selection

The GCLK\_TCx is fed into the internal prescaler.

The prescaler consists of a counter that counts up to the selected prescaler value, whereupon the output of the prescaler toggles.

If the prescaler value is higher than one, the counter update condition can be optionally executed on the next GCLK\_TCx clock pulse or the next prescaled clock pulse. For further details, refer to Prescaler (CTRLA.PRESCALER) and Counter Synchronization (CTRLA.PRESYNC) description.

Prescaler outputs from 1 to 1/1024 are available. For a complete list of available prescaler outputs, see the register description for the Prescaler bit group in the Control A register (CTRLA.PRESCALER).

**Note:** When counting events, the prescaler is bypassed.

The joint stream of prescaler ticks and event action ticks is called CLK\_TC\_CNT.

**Figure 35-2. Prescaler**



### 35.6.2.4 Counter Mode

The counter mode is selected by the Mode bit group in the Control A register (CTRLA.MODE). By default, the counter is enabled in the 16-bit counter resolution. Three counter resolutions are available:

- COUNT8: The 8-bit TC has its own Period Value and Period Buffer Value registers (PER and PERBUF).
- COUNT16: 16-bit is the default counter mode. There is no dedicated period register in this mode.
- COUNT32: This mode is achieved by pairing two 16-bit TC peripherals. TC0 is paired with TC1, and TC2 is paired with TC3. TC4 does not support 32-bit resolution.

When paired, the TC peripherals are configured using the registers of the even-numbered TC (TC0 or TC2 respectively). The odd-numbered partner (TC1 or TC3 respectively) will act as slave, and the Slave bit in the Status register (STATUS.SLAVE) will be set. The register values of a slave will

not reflect the registers of the 32-bit counter. Writing to any of the slave registers will not affect the 32-bit counter. Normal access to the slave COUNT and CCx registers is not allowed.

### 35.6.2.5 Counter Operations

Depending on the mode of operation, the counter is cleared, reloaded, incremented, or decremented at each TC clock input (CLK\_TC\_CNT). A counter clear or reload marks the end of the current counter cycle and the start of a new one.

The counting direction is set by the Direction bit in the Control B register (CTRLB.DIR). If this bit is zero the counter is counting up, and counting down if CTRLB.DIR=1. The counter will count up or down for each tick (clock or event) until it reaches TOP or ZERO. When it is counting up and TOP is reached, the counter will be set to zero at the next tick (overflow) and the Overflow Interrupt Flag in the Interrupt Flag Status and Clear register (INTFLAG.OVF) will be set. When it is counting down, the counter is reloaded with the TOP value when ZERO is reached (underflow), and INTFLAG.OVF is set.

INTFLAG.OVF can be used to trigger an interrupt, a DMA request, or an event. An overflow/underflow occurrence (i.e. a compare match with TOP/ZERO) will stop counting if the One-Shot bit in the Control B register is set (CTRLBSET.ONESHOT).

It is possible to change the counter value (by writing directly in the COUNT register) even when the counter is running. When starting the TC, the COUNT value will be either ZERO or TOP (depending on the counting direction set by CTRLBSET.DIR or CTRLBCLR.DIR), unless a different value has been written to it, or the TC has been stopped at a value other than ZERO. The write access has higher priority than count, clear, or reload. The direction of the counter can also be changed during normal operation. See also the figure below.

**Figure 35-3. Counter Operation**



Due to asynchronous clock domains, the internal counter settings are written when the synchronization is complete. Normal operation must be used when using the counter as timer base for the capture channels.

#### Stop Command and Event Action

A Stop command can be issued from software by using Command bits in the Control B Set register (CTRLBSET.CMD = 0x2, STOP). When a Stop is detected while the counter is running, the counter will be loaded with the starting value (ZERO or TOP, depending on direction set by CTRLBSET.DIR or CTRLBCLR.DIR). All waveforms are cleared and the Stop bit in the Status register is set (STATUS.STOP).

## Re-Trigger Command and Event Action

A re-trigger command can be issued from software by writing the Command bits in the Control B Set register (CTRLBSET.CMD = 0x1, RETRIGGER), or from event when a re-trigger event action is configured in the Event Control register (EVCTRL.EVACT = 0x1, RETRIGGER).

When the command is detected during counting operation, the counter will be reloaded or cleared, depending on the counting direction (CTRLBSET.DIR or CTRLBCLR.DIR). When the re-trigger command is detected while the counter is stopped, the counter will resume counting from the current value in the COUNT register.

**Note:** When a re-trigger event action is configured in the Event Action bits in the Event Control register (EVCTRL.EVACT=0x1, RETRIGGER), enabling the counter will not start the counter. The counter will start on the next incoming event and restart on corresponding following event.

## Count Event Action

The TC can count events. When an event is received, the counter increases or decreases the value, depending on direction settings (CTRLBSET.DIR or CTRLBCLR.DIR). The count event action can be selected by the Event Action bit group in the Event Control register (EVCTRL.EVACT=0x2, COUNT).

## Start Event Action

The TC can start counting operation on an event when previously stopped. In this configuration, the event has no effect if the counter is already counting. When the peripheral is enabled, the counter operation starts when the event is received or when a re-trigger software command is applied.

The Start TC on Event action can be selected by the Event Action bit group in the Event Control register (EVCTRL.EVACT=0x3, START).

### 35.6.2.6 Compare Operations

By default, the Compare/Capture channel is configured for compare operations.

When using the TC and the Compare/Capture Value registers (CCx) for compare operations, the counter value is continuously compared to the values in the CCx registers. This can be used for timer or for waveform operation.

The Channel x Compare Buffer (CCBUFx) registers provide double buffer capability. The double buffering synchronizes the update of the CCx register with the buffer value at the UPDATE condition or a forced update command (CTRLBSET.CMD=UPDATE). For further details, refer to [Double Buffering](#). The synchronization prevents the occurrence of odd-length, non-symmetrical pulses and ensures glitch-free output.

## Waveform Output Operations

The compare channels can be used for waveform generation on output port pins. To make the waveform available on the connected pin, the following requirements must be fulfilled:

1. Choose a waveform generation mode in the Waveform Generation Operation bit in Waveform register (WAVE.WAVEGEN).
2. Optionally invert the waveform output WO[x] by writing the corresponding Output Waveform x Invert Enable bit in the Driver Control register (DRVCTRL.INVENx).
3. Configure the pins with the I/O Pin Controller. Refer to *PORT - I/O Pin Controller* for details.

The counter value is continuously compared with each CCx value. On a comparison match, the Match or Capture Channel x bit in the Interrupt Flag Status and Clear register (INTFLAG.MCx) will be set on the next zero-to-one transition of CLK\_TC\_CNT (see Normal Frequency Operation). An interrupt/and or event can be generated on comparison match if enabled. The same condition generates a DMA request.



There are four waveform configurations for the Waveform Generation Operation bit group in the Waveform register (WAVE.WAVEGEN). This will influence how the waveform is generated and impose restrictions on the top value. The configurations are:

- Normal frequency (NFRQ)
- Match frequency (MFRQ)
- Normal pulse-width modulation (NPWM)
- Match pulse-width modulation (MPWM)

When using NPWM or NFRQ configuration, the TOP will be determined by the counter resolution. In 8-bit counter mode, the Period register (PER) is used as TOP, and the TOP can be changed by writing to the PER register. In 16- and 32-bit counter mode, TOP is fixed to the maximum (MAX) value of the counter.

### Normal Frequency Generation (NFRQ)

For Normal Frequency Generation, the period time (T) is controlled by the period register (PER) for 8-bit counter mode and MAX for 16- and 32-bit mode. The waveform generation output (WO[x]) is toggled on each compare match between COUNT and CCx, and the corresponding Match or Capture Channel x Interrupt Flag (INTFLAG.MCx) will be set.

**Figure 35-4. Normal Frequency Operation**

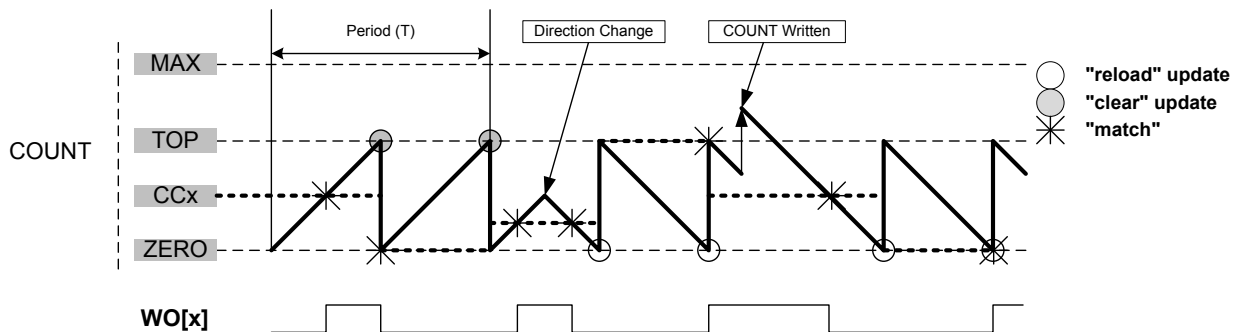

### Match Frequency Generation (MFRQ)

For Match Frequency Generation, the period time (T) is controlled by the CC0 register instead of PER or MAX. WO[0] toggles on each update condition.

**Figure 35-5. Match Frequency Operation**



### Normal Pulse-Width Modulation Operation (NPWM)

NPWM uses single-slope PWM generation.

For single-slope PWM generation, the period time (T) is controlled by the TOP value, and CCx controls the duty cycle of the generated waveform output. When up-counting, the WO[x] is set at start or compare

match between the COUNT and TOP values, and cleared on compare match between COUNT and CCx register values. When down-counting, the WO[x] is cleared at start or compare match between the COUNT and ZERO values, and set on compare match between COUNT and CCx register values.

The following equation calculates the exact resolution for a single-slope PWM ( $R_{PWM\_SS}$ ) waveform:

$$R_{PWM\_SS} = \frac{\log(TOP+1)}{\log(2)}$$

The PWM frequency ( $f_{PWM\_SS}$ ) depends on TOP value and the peripheral clock frequency ( $f_{GCLK\_TCC}$ ), and can be calculated by the following equation:

$$f_{PWM\_SS} = \frac{f_{GCLK\_TC}}{N(TOP+1)}$$

Where N represents the prescaler divider used (1, 2, 4, 8, 16, 64, 256, 1024).

### Match Pulse-Width Modulation Operation (MPWM)

In MPWM, the output of WO[1] is depending on CC1 as shown in the figure below. On every overflow/underflow, a one-TC-clock-cycle negative pulse is put out on WO[0] (not shown in the figure).

**Figure 35-6. Match PWM Operation**



The table below shows the update counter and overflow event/interrupt generation conditions in different operation modes.

**Table 35-3. Counter Update and Overflow Event/interrupt Conditions in TC**

Name	Operation	TOP	Update	Output Waveform		OVFIF/Event	
				On Match	On Update	Up	Down
NFRQ	Normal Frequency	PER	TOP/ ZERO	Toggle	Stable	TOP	ZERO
MFRQ	Match Frequency	CC0	TOP/ ZERO	Toggle	Stable	TOP	ZERO
NPWM	Single-slope PWM	PER	TOP/ ZERO	See description above.		TOP	ZERO
MPWM	Single-slope PWM	CC0	TOP/ ZERO	Toggle	Toggle	TOP	ZERO

### Related Links

[PORT: IO Pin Controller](#)

#### 35.6.2.7 Double Buffering

The Compare Channels (CCx) registers, and the Period (PER) register in 8-bit mode are double buffered. Each buffer register has a buffer valid bit (CCBUFVx or PERBUFV) in the STATUS register, which indicates that the buffer register contains a new valid value that can be copied into the corresponding register. As long as the respective buffer valid status flag (PERBUFV or CCBUFVx) are set to '1', related

syncbusy bits are set (SYNCBUSY.PER or SYNCBUSY.CCx), a write to the respective PER/PERBUF or CCx/CCBUFx registers will generate a PAC error, and access to the respective PER or CCx register is invalid.

When the buffer valid flag bit in the STATUS register is '1' and the Lock Update bit in the CTRLB register is set to '0', (writing CTRLBCLR.LUPD to '1'), double buffering is enabled: the data from buffer registers will be copied into the corresponding register under hardware UPDATE conditions, then the buffer valid flags bit in the STATUS register are automatically cleared by hardware.

**Note:** The software update command (CTRLBSET.CMD=0x3) is acting independently of the LUPD value.

A compare register is double buffered as in the following figure.

**Figure 35-7. Compare Channel Double Buffering**



Both the registers (PER/CCx) and corresponding buffer registers (PERBUF/CCBUFx) are available in the I/O register map, and the double buffering feature is not mandatory. The double buffering is disabled by writing a '1' to CTRLBSET.LUPD.

Note: In NFRQ, MFRQ or PWM down-counting counter mode (CTRLBSET.DIR=1), when double buffering is enabled (CTRLBCLR.LUPD=1), PERBUF register is continuously copied into the PER independently of update conditions.

### Changing the Period

The counter period can be changed by writing a new TOP value to the Period register (PER or CC0, depending on the waveform generation mode), any period update on registers (PER or CCx) is effective after the synchronization delay, whatever double buffering enabling is.

Figure 35-8. Unbuffered Single-Slope Up-Counting Operation



A counter wraparound can occur in any operation mode when up-counting without buffering, see [Figure 35-8](#).

COUNT and TOP are continuously compared, so when a new TOP value that is lower than current COUNT is written to TOP, COUNT will wrap before a compare match.

Figure 35-9. Unbuffered Single-Slope Down-Counting Operation



When double buffering is used, the buffer can be written at any time and the counter will still maintain correct operation. The period register is always updated on the update condition, as shown in [Figure 35-10](#). This prevents wraparound and the generation of odd waveforms.

Figure 35-10. Changing the Period Using Buffering



35.6.2.8 Capture Operations

To enable and use capture operations, the corresponding Capture Channel x Enable bit in the Control A register (CTRLA.CAPTENx) must be written to '1'.

A capture trigger can be provided by input event line TC\_EV or by asynchronous IO pin WO[x] for each capture channel or by a TC event. To enable the capture from input event line, Event Input Enable bit in the Event Control register (EVCTRL.TCEI) must be written to '1'. To enable the capture from the IO pin, the Capture On Pin x Enable bit in CTRLA register (CTRLA.COPENx) must be written to '1'.

**Note:** The RETRIGGER, COUNT and START event actions are available only on an event from the Event System.

By default, a capture operation is done when a rising edge is detected on the input signal. Capture on falling edge is available, its activation is depending on the input source:

- When the channel is used with a IO pin, write a '1' to the corresponding Invert Enable bit in the Drive Control register (DRVCTRL.INVENx).
- When the channel is counting events from the Event System, write a '1' to the TC Event Input Invert Enable bit in Event Control register (EVCTRL.TCINV).

For input capture, the buffer register and the corresponding CCx act like a FIFO. When CCx is empty or read, any content in CCBUFx is transferred to CCx. The buffer valid flag is passed to set the CCx interrupt flag (IF) and generate the optional interrupt, event or DMA request. CCBUFx register value can't be read, all captured data must be read from CCx register.

Figure 35-11. Capture Double Buffering



For input capture, the buffer register and the corresponding CCx act like a FIFO. When CCx is empty or read, any content in CCBUFx is transferred to CCx. The buffer valid flag is passed to set the CCx interrupt flag (IF) and generate the optional interrupt, event or DMA request. CCBUFx register value can't be read, all captured data must be read from CCx register.

### Event Capture Action

The compare/capture channels can be used as input capture channels to capture events from the Event System or from the corresponding IO pin, and give them a timestamp. The following figure shows four capture events for one capture channel.

**Figure 35-12. Input Capture Timing**

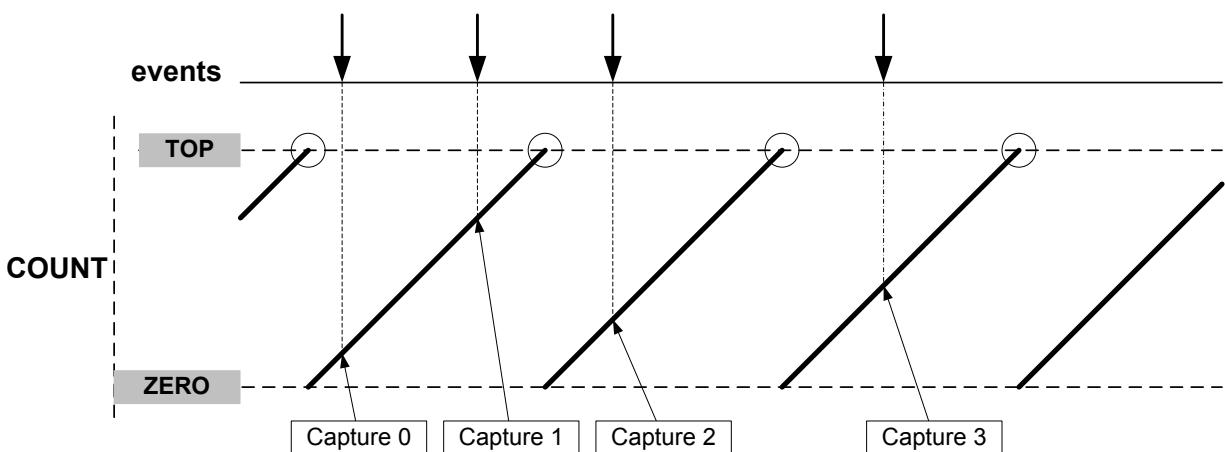

The TC can detect capture overflow of the input capture channels: When a new capture event is detected while the Capture Interrupt flag (INTFLAG.MCx) is still set, the new timestamp will not be stored and INTFLAG.ERR will be set.

### Period and Pulse-Width (PPW) Capture Action

The TC can perform two input captures and restart the counter on one of the edges. This enables the TC to measure the pulse width and period and to characterize the frequency  $f$  and duty cycle of an input signal:

$$f = \frac{1}{T}$$

$$\text{dutyCycle} = \frac{t_p}{T}$$

Figure 35-13. PWP Capture



Selecting PWP in the Event Action bit group in the Event Control register (EVCTRL.EVACT) enables the TC to perform one capture action on the rising edge and the other one on the falling edge. The period  $T$  will be captured into CC1 and the pulse width  $t_p$  in CC0. EVCTRL.EVACT=PPW (period and pulse-width) offers identical functionality, but will capture  $T$  into CC0 and  $t_p$  into CC1.

The TC Event Input Invert Enable bit in the Event Control register (EVCTRL.TCINV) is used to select whether the wraparound should occur on the rising edge or the falling edge. If EVCTRL.TCINV=1, the wraparound will happen on the falling edge. This also be for DRVCTRL.INVENx if pin capture is enabled.

The TC can detect capture overflow of the input capture channels: When a new capture event is detected while the Capture Interrupt flag (INTFLAG.MCx) is still set, the new timestamp will not be stored and INTFLAG.ERR will be set.

**Note:** The corresponding capture is working only if the channel is enabled in capture mode (CTRLA.CAPTENx=1). If not, the capture action is ignored and the channel is enabled in compare mode of operation. Consequently, both channels must be enabled in order to fully characterize the input.

#### Pulse-Width Capture Action

The TC performs the input capture on the falling edge of the input signal. When the edge is detected, the counter value is cleared and the TC stops counting. When a rising edge is detected on the input signal, the counter restarts the counting operation. To enable the operation on opposite edges, the input signal to capture must be inverted (refer to DRVCTRL.INVEN or EVCTRL.TCEINV).

Figure 35-14. Pulse-Width Capture on Channel 0



The TC can detect capture overflow of the input capture channels: When a new capture event is detected while the Capture Interrupt flag (INTFLAG.MCx) is still set, the new timestamp will not be stored and INTFLAG.ERR will be set.

### 35.6.3 Additional Features

#### 35.6.3.1 One-Shot Operation

When one-shot is enabled, the counter automatically stops on the next counter overflow or underflow condition. When the counter is stopped, the Stop bit in the Status register (STATUS.STOP) is automatically set and the waveform outputs are set to zero.

One-shot operation is enabled by writing a '1' to the One-Shot bit in the Control B Set register (CTRLBSET.ONESHOT), and disabled by writing a '0' to CTRLBCLR.ONESHOT. When enabled, the TC will count until an overflow or underflow occurs and stops counting operation. The one-shot operation can be restarted by a re-trigger software command, a re-trigger event, or a start event. When the counter restarts its operation, STATUS.STOP is automatically cleared.

#### 35.6.3.2 Time-Stamp Capture

This feature is enabled when the Capture Time Stamp (STAMP) Event Action in Event Control register (EVCTRL.EVACT) is selected. The counter TOP value must be smaller than MAX.

When a capture event is detected, the COUNT value is copied into the corresponding Channel x Compare/Capture Value (CCx) register. In case of an overflow, the MAX value is copied into the corresponding CCx register.

When a valid captured value is present in the capture channel register, the corresponding Capture Channel x Interrupt Flag (INTFLAG.MCx) is set.

The timer/counter can detect capture overflow of the input capture channels: When a new capture event is detected while the Capture Channel interrupt flag (INTFLAG.MCx) is still set, the new time-stamp will not be stored and INTFLAG.ERR will be set.



Figure 35-15. Time-Stamp



### 35.6.3.3 Minimum Capture

The minimum capture is enabled by writing the CAPTMIN mode in the Channel n Capture Mode bits in the Control A register (CTRLA.CAPTMODEn = CAPTMIN).

*CCx Content:*

In CAPTMIN operations, CCx keeps the Minimum captured values. Before enabling this mode of capture, the user must initialize the corresponding CCx register value to a value different from zero. If the CCx register initial value is zero, no captures will be performed using the corresponding channel.

*MCx Behaviour:*

In CAPTMIN operation, capture is performed only when on capture event time, the counter value is lower than the last captured value. The MCx interrupt flag is set only when on capture event time, the counter value is upper or equal to the value captured on the previous event. So interrupt flag is set when a new absolute local Minimum value has been detected.

### 35.6.3.4 Maximum Capture

The maximum capture is enabled by writing the CAPTMAX mode in the Channel n Capture Mode bits in the Control A register (CTRLA.CAPTMODEn = CAPTMAX).

*CCx Content:*

In CAPTMAX operations, CCx keeps the Maximum captured values. Before enabling this mode of capture, the user must initialize the corresponding CCx register value to a value different from TOP. If the CCx register initial value is TOP, no captures will be performed using the corresponding channel.

*MCx Behaviour:*

In CAPTMAX operation, capture is performed only when on capture event time, the counter value is upper than the last captured value. The MCx interrupt flag is set only when on capture event time, the counter value is lower or equal to the value captured on the previous event. So interrupt flag is set when a new absolute local Maximum value has been detected.

Figure 35-16. Maximum Capture Operation with CC0 Initialized with ZERO Value



### 35.6.4 DMA Operation

The TC can generate the following DMA requests:

- Overflow (OVF): the request is set when an update condition (overflow, underflow or re-trigger) is detected, the request is cleared by hardware on DMA acknowledge.
- Match or Capture Channel x (MCx): for a compare channel, the request is set on each compare match detection, the request is cleared by hardware on DMA acknowledge. For a capture channel, the request is set when valid data is present in the CCx register, and cleared when CCx register is read.

### 35.6.5 Interrupts

The TC has the following interrupt sources:

- Overflow/Underflow (OVF)
- Match or Capture Channel x (MCx)
- Capture Overflow Error (ERR)

Each interrupt source has an interrupt flag associated with it. The interrupt flag in the Interrupt Flag Status and Clear register (INTFLAG) is set when the interrupt condition occurs.

Each interrupt can be individually enabled by writing a '1' to the corresponding bit in the Interrupt Enable Set register (INTENSET), and disabled by writing a '1' to the corresponding bit in the Interrupt Enable Clear register (INTENCLR).

An interrupt request is generated when the interrupt flag is set and the corresponding interrupt is enabled. The interrupt request remains active until either the interrupt flag is cleared, the interrupt is disabled, or the TC is reset. See [INTFLAG](#) for details on how to clear interrupt flags.

The TC has one common interrupt request line for all the interrupt sources. The user must read the INTFLAG register to determine which interrupt condition is present.

Note that interrupts must be globally enabled for interrupt requests to be generated. Refer to *Nested Vector Interrupt Controller* for details.

#### Related Links

[Nested Vector Interrupt Controller](#)

### 35.6.6 Events

The TC can generate the following output events:

- Overflow/Underflow (OVF)
- Match or Capture Channel x (MCx)

Writing a '1' to an Event Output bit in the Event Control register (EVCTRL.MCEOx) enables the corresponding output event. The output event is disabled by writing EVCTRL.MCEOx=0.

One of the following event actions can be selected by the Event Action bit group in the Event Control register (EVCTRL.EVACT):

- Disable event action (OFF)
- Start TC (START)
- Re-trigger TC (RETRIGGER)
- Count on event (COUNT)
- Capture time stamp (STAMP)
- Capture Period (PPW and PWP)
- Capture Pulse Width (PW)

Writing a '1' to the TC Event Input bit in the Event Control register (EVCTRL.TCEI) enables input events to the TC. Writing a '0' to this bit disables input events to the TC. The TC requires only asynchronous event inputs. For further details on how configuring the asynchronous events, refer to *EVSYS - Event System*.

#### Related Links

[EVSYS – Event System](#)

### 35.6.7 Sleep Mode Operation

The TC can be configured to operate in any sleep mode. To be able to run in standby, the RUNSTDBY bit in the Control A register (CTRLA.RUNSTDBY) must be '1'. This peripheral can wake up the device from any sleep mode using interrupts or perform actions through the Event System.

If the On Demand bit in the Control A register (CTRLA.ONDEMAND) is written to '1', the module stops requesting its peripheral clock when the STOP bit in STATUS register (STATUS.STOP) is set to '1'. When a re-trigger or start condition is detected, the TC requests the clock before the operation starts.

### 35.6.8 Synchronization

Due to asynchronicity between the main clock domain and the peripheral clock domains, some registers need to be synchronized when written or read.

The following bits are synchronized when written:

- Software Reset and Enable bits in Control A register (CTRLA.SWRST and CTRLA.ENABLE)
- Capture Channel Buffer Valid bit in STATUS register (STATUS.CCBUFVx)

The following registers are synchronized when written:

- Control B Clear and Control B Set registers (CTRLBCLR and CTRLBSET)
- Count Value register (COUNT)
- Period Value and Period Buffer Value registers (PER and PERBUF)
- Channel x Compare/Capture Value and Channel x Compare/Capture Buffer Value registers (CCx and CCBUFx)

The following registers are synchronized when read:

- Count Value register (COUNT): synchronization is done on demand through READSYNC command (CTRLBSET.CMD).

Required write-synchronization is denoted by the "Write-Synchronized" property in the register description.

Required read-synchronization is denoted by the "Read-Synchronized" property in the register description.

## 35.7 Register Description

Registers can be 8, 16, or 32 bits wide. Atomic 8-, 16- and 32-bit accesses are supported. In addition, the 8-bit quarters and 16-bit halves of a 32-bit register, and the 8-bit halves of a 16-bit register can be accessed directly.

Some registers are optionally write-protected by the Peripheral Access Controller (PAC). Optional PAC write-protection is denoted by the "PAC Write-Protection" property in each individual register description. For details, refer to [Register Access Protection](#).

Some registers are synchronized when read and/or written. Synchronization is denoted by the "Write-Synchronized" or the "Read-Synchronized" property in each individual register description. For details, refer to [Synchronization](#).

Some registers are enable-protected, meaning they can only be written when the peripheral is disabled. Enable-protection is denoted by the "Enable-Protected" property in each individual register description.

## 35.7.1 Register Summary - 8-bit Mode

Offset	Name	Bit Pos.									
0x00	CTRLA	7:0	ONDEMAND	RUNSTDBY	PRESCSYNC[1:0]	MODE[1:0]	ENABLE	SWRST			
0x01		15:8				ALOCK	PRESCALER[2:0]				
0x02		23:16			COPEN1	COPEN0		CAPTEN1	CAPTEN0		
0x03		31:24				CAPTMODE1[1:0]		CAPTMODE0[1:0]			
0x04	CTRLBCLR	7:0	CMD[2:0]				ONESHOT	LUPD	DIR		
0x05	CTRLBSET	7:0	CMD[2:0]				ONESHOT	LUPD	DIR		
0x06	EVCTRL	7:0		TCEI	TCINV		EVACT[2:0]				
0x07		15:8		MCEOx	MCEOx				OVFEO		
0x08	INTENCLR	7:0			MCx		ERR	OVF			
0x09	INTENSET	7:0			MCx		ERR	OVF			
0x0A	INTFLAG	7:0			MCx		ERR	OVF			
0x0B	STATUS	7:0			CCBUFVx	PERBUFV		SLAVE	STOP		
0x0C	WAVE	7:0						WAVEGEN[1:0]			
0x0D	DRVCTRL	7:0							INVENx		
0x0E	Reserved										
0x0F	DBGCTRL	7:0							DBGRUN		
0x10	SYNDBUSY	7:0		CCx	PER	COUNT	STATUS	CTRLB	ENABLE	SWRST	
0x11		15:8									
0x12		23:16									
0x13		31:24									
0x14	COUNT	7:0	COUNT[7:0]								
0x15	Reserved										
0x1A											
0x1B	PER	7:0	PER[7:0]								
0x1C	CC0	7:0	CC[7:0]								
0x1D	CC1	7:0	CC[7:0]								
0x1E	Reserved										
0x2E											
0x2F	PERBUF	7:0	PERBUF[7:0]								
0x30	CCBUF0	7:0	CCBUF[7:0]								
0x31	CCBUF1	7:0	CCBUF[7:0]								

### 35.7.1.1 Control A

**Name:** CTRLA

**Offset:** 0x00 [ID-00001cd8]

**Reset:** 0x00000000

**Property:** PAC Write-Protection, Write-Synchronized, Enable-Protected

Bit	31	30	29	28	27	26	25	24
			CAPTMODE1[1:0]			CAPTMODE0[1:0]		
Access				R/W	R/W	R/W		R/W
Reset				0	0	0		0
Bit	23	22	21	20	19	18	17	16
			COPEN1	COPEN0			CAPTEN1	CAPTEN0
Access			R/W	R/W			R/W	R/W
Reset			0	0			0	0
Bit	15	14	13	12	11	10	9	8
					ALOCK	PRESCALER[2:0]		
Access					R/W	R/W	R/W	R/W
Reset					0	0	0	0
Bit	7	6	5	4	3	2	1	0
	ONDEMAND	RUNSTDBY	PRESCSYNC[1:0]		MODE[1:0]		ENABLE	SWRST
Access	R/W	R/W	R/W	R/W	R/W	R/W	R/W	W
Reset	0	0	0	0	0	0	0	0

### Bits 28:27 – CAPTMODE1[1:0]: Capture mode Channel 1

These bits select the channel 1 capture mode.

Value	Name	Description
0x0	DEFAULT	Default capture
0x1	CAPTMIN	Minimum capture
0x2	CAPTMAX	Maximum capture
0x3		Reserved

### Bits 25:24 – CAPTMODE0[1:0]: Capture mode Channel 0

These bits select the channel 0 capture mode.

Value	Name	Description
0x0	DEFAULT	Default capture
0x1	CAPTMIN	Minimum capture
0x2	CAPTMAX	Maximum capture
0x3		Reserved

### Bits 20, 21 – COPENx: Capture On Pin x Enable

Bit x of COPEN[1:0] selects the trigger source for capture operation, either events or I/O pin input.

Value	Description
0	Event from Event System is selected as trigger source for capture operation on channel x.
1	I/O pin is selected as trigger source for capture operation on channel x.

### Bits 16, 17 – CAPTENx: Capture Channel x Enable

Bit x of CAPTEN[1:0] selects whether channel x is a capture or a compare channel.

These bits are not synchronized.

Value	Description
0	CAPTEN disables capture on channel x.
1	CAPTEN enables capture on channel x.

### Bit 11 – ALOCK: Auto Lock

When this bit is set, Lock bit update (LUPD) is set to '1' on each overflow/underflow or re-trigger event.

This bit is not synchronized.

Value	Description
0	The LUPD bit is not affected on overflow/underflow, and re-trigger event.
1	The LUPD bit is set on each overflow/underflow or re-trigger event.

### Bits 10:8 – PRESCALER[2:0]: Prescaler

These bits select the counter prescaler factor.

These bits are not synchronized.

Value	Name	Description
0x0	DIV1	Prescaler: GCLK_TC
0x1	DIV2	Prescaler: GCLK_TC/2
0x2	DIV4	Prescaler: GCLK_TC/4
0x3	DIV8	Prescaler: GCLK_TC/8
0x4	DIV16	Prescaler: GCLK_TC/16
0x5	DIV64	Prescaler: GCLK_TC/64
0x6	DIV256	Prescaler: GCLK_TC/256
0x7	DIV1024	Prescaler: GCLK_TC/1024

### Bit 7 – ONDEMAND: Clock On Demand

This bit selects the clock requirements when the TC is stopped.

In standby mode, if the Run in Standby bit (CTRLA.RUNSTDBY) is '0', ONDEMAND is forced to '0'.

This bit is not synchronized.

Value	Description
0	The On Demand is disabled. If On Demand is disabled, the TC will continue to request the clock when its operation is stopped (STATUS.STOP=1).
1	The On Demand is enabled. When On Demand is enabled, the stopped TC will not request the clock. The clock is requested when a software re-trigger command is applied or when an event with start/re-trigger action is detected.

### Bit 6 – RUNSTDBY: Run in Standby

This bit is used to keep the TC running in standby mode.

This bit is not synchronized.

Value	Description
0	The TC is halted in standby.
1	The TC continues to run in standby.

### Bits 5:4 – PRESCSYNC[1:0]: Prescaler and Counter Synchronization

These bits select whether the counter should wrap around on the next GCLK\_TCx clock or the next prescaled GCLK\_TCx clock. It also makes it possible to reset the prescaler.

These bits are not synchronized.

Value	Name	Description
0x0	GCLK	Reload or reset the counter on next generic clock
0x1	PRESC	Reload or reset the counter on next prescaler clock
0x2	RESYNC	Reload or reset the counter on next generic clock. Reset the prescaler counter
0x3	-	Reserved

### Bits 3:2 – MODE[1:0]: Timer Counter Mode

These bits select the counter mode.

These bits are not synchronized.

Value	Name	Description
0x0	COUNT16	Counter in 16-bit mode
0x1	COUNT8	Counter in 8-bit mode
0x2	COUNT32	Counter in 32-bit mode
0x3	-	Reserved

### Bit 1 – ENABLE: Enable

Due to synchronization, there is delay from writing CTRLA.ENABLE until the peripheral is enabled/disabled. The value written to CTRLA.ENABLE will read back immediately, and the ENABLE Synchronization Busy bit in the SYNCBUSY register (SYNCBUSY.ENABLE) will be set. SYNCBUSY.ENABLE will be cleared when the operation is complete.

This bit is not enable protected.

Value	Description
0	The peripheral is disabled.
1	The peripheral is enabled.

### Bit 0 – SWRST: Software Reset

Writing a '0' to this bit has no effect.

Writing a '1' to this bit resets all registers in the TC, except DBGCTRL, to their initial state, and the TC will be disabled.

Writing a '1' to CTRLA.SWRST will always take precedence; all other writes in the same write-operation will be discarded.

Due to synchronization there is a delay from writing CTRLA.SWRST until the reset is complete. CTRLA.SWRST and SYNCBUSY.SWRST will both be cleared when the reset is complete.

This bit is not enable protected.

Value	Description
0	There is no reset operation ongoing.
1	The reset operation is ongoing.

#### 35.7.1.2 Control B Clear

This register allows the user to clear bits in the CTRLB register without doing a read-modify-write operation. Changes in this register will also be reflected in the Control B Set register (CTRLBSET).



**Name:** CTRLBCLR  
**Offset:** 0x04 [ID-00001cd8]  
**Reset:** 0x00  
**Property:** PAC Write-Protection, Read-Synchronized, Write-Synchronized

	7	6	5	4	3	2	1	0
	CMD[2:0]					ONESHOT	LUPD	DIR
Access	R/W	R/W	R/W			R/W	R/W	R/W
Reset	0	0	0			0	0	0

### Bits 7:5 – CMD[2:0]: Command

These bits are used for software control of the TC. The commands are executed on the next prescaled GCLK\_TC clock cycle. When a command has been executed, the CMD bit group will be read back as zero.

Writing 0x0 to these bits has no effect.

Writing a '1' to any of these bits will clear the pending command.

### Bit 2 – ONESHOT: One-Shot on Counter

This bit controls one-shot operation of the TC.

Writing a '0' to this bit has no effect

Writing a '1' to this bit will disable one-shot operation.

Value	Description
0	The TC will wrap around and continue counting on an overflow/underflow condition.
1	The TC will wrap around and stop on the next underflow/overflow condition.

### Bit 1 – LUPD: Lock Update

This bit controls the update operation of the TC buffered registers.

When CTRLB.LUPD is set, no any update of the registers with value of its buffered register is performed on hardware UPDATE condition. Locking the update ensures that all buffer registers are valid before an hardware update is performed. After all the buffer registers are loaded correctly, the buffered registers can be unlocked.

This bit has no effect when input capture operation is enabled.

Writing a '0' to this bit has no effect.

Writing a '1' to this bit will clear the LUPD bit.

Value	Description
0	The CCBUFx and PERBUF buffer registers value are copied into CCx and PER registers on hardware update condition.
1	The CCBUFx and PERBUF buffer registers value are not copied into CCx and PER registers on hardware update condition.

### Bit 0 – DIR: Counter Direction

This bit is used to change the direction of the counter.

Writing a '0' to this bit has no effect.

Writing a '1' to this bit will clear the bit and make the counter count up.

Value	Description
0	The timer/counter is counting up (incrementing).
1	The timer/counter is counting down (decrementing).

### 35.7.1.3 Control B Set

This register allows the user to set bits in the CTRLB register without doing a read-modify-write operation. Changes in this register will also be reflected in the Control B Clear register (CTRLBCLR).

**Name:** CTRLBSET

**Offset:** 0x05 [ID-00001cd8]

**Reset:** 0x00

**Property:** PAC Write-Protection, Read-synchronized, Write-Synchronized

Bit	7	6	5	4	3	2	1	0
	CMD[2:0]					ONESHOT	LUPD	DIR
Access	R/W	R/W	R/W			R/W	R/W	R/W
Reset	0	0	0			0	0	0

#### Bits 7:5 – CMD[2:0]: Command

These bits are used for software control of the TC. The commands are executed on the next prescaled GCLK\_TC clock cycle. When a command has been executed, the CMD bit group will be read back as zero.

Writing 0x0 to these bits has no effect.

Writing a value different from 0x0 to these bits will issue a command for execution.

Value	Name	Description
0x0	NONE	No action
0x1	RETRIGGER	Force a start, restart or retrigger
0x2	STOP	Force a stop
0x3	UPDATE	Force update of double buffered registers
0x4	READSYNC	Force a read synchronization of COUNT

#### Bit 2 – ONESHOT: One-Shot on Counter

This bit controls one-shot operation of the TC.

Writing a '0' to this bit has no effect.

Writing a '1' to this bit will enable one-shot operation.

Value	Description
0	The TC will wrap around and continue counting on an overflow/underflow condition.
1	The TC will wrap around and stop on the next underflow/overflow condition.

#### Bit 1 – LUPD: Lock Update

This bit controls the update operation of the TC buffered registers.

When CTRLB.LUPD is set, no any update of the registers with value of its buffered register is performed on hardware UPDATE condition. Locking the update ensures that all buffer registers are valid before an hardware update is performed. After all the buffer registers are loaded correctly, the buffered registers can be unlocked.

Writing a '0' to this bit has no effect.

Writing a '1' to this bit will set the LUPD bit.

This bit has no effect when input capture operation is enabled.

Value	Description
0	The CCBUFx and PERBUF buffer registers value are copied into CCx and PER registers on hardware update condition.
1	The CCBUFx and PERBUF buffer registers value are not copied into CCx and PER registers on hardware update condition.

### Bit 0 – DIR: Counter Direction

This bit is used to change the direction of the counter.

Writing a '0' to this bit has no effect

Writing a '1' to this bit will clear the bit and make the counter count up.

Value	Description
0	The timer/counter is counting up (incrementing).
1	The timer/counter is counting down (decrementing).

## 35.7.1.4 Event Control

**Name:** EVCTRL

**Offset:** 0x06 [ID-00001cd8]

**Reset:** 0x0000

**Property:** PAC Write-Protection, Enable-Protected

Bit	15	14	13	12	11	10	9	8
			MCEOx	MCEOx				OVFEO
Access			R/W	R/W				R/W
Reset			0	0				0
Bit	7	6	5	4	3	2	1	0
			TCEI	TCINV		EVACT[2:0]		
Access			R/W	R/W		R/W	R/W	R/W
Reset			0	0		0	0	0

### Bits 13,12 – MCEOx: Match or Capture Channel x Event Output Enable [x = 1..0]

These bits enable the generation of an event for every match or capture on channel x.

Value	Description
0	Match/Capture event on channel x is disabled and will not be generated.
1	Match/Capture event on channel x is enabled and will be generated for every compare/capture.

### Bit 8 – OVFEO: Overflow/Underflow Event Output Enable

This bit enables the Overflow/Underflow event. When enabled, an event will be generated when the counter overflows/underflows.

Value	Description
0	Overflow/Underflow event is disabled and will not be generated.
1	Overflow/Underflow event is enabled and will be generated for every counter overflow/underflow.

### Bit 5 – TCEI: TC Event Enable

This bit is used to enable asynchronous input events to the TC.

Value	Description
0	Incoming events are disabled.
1	Incoming events are enabled.

### Bit 4 – TCINV: TC Inverted Event Input Polarity

This bit inverts the asynchronous input event source.

Value	Description
0	Input event source is not inverted.
1	Input event source is inverted.

### Bits 2:0 – EVACT[2:0]: Event Action

These bits define the event action the TC will perform on an event.

Value	Name	Description
0x0	OFF	Event action disabled
0x1	RETRIGGER	Start, restart or retrigger TC on event
0x2	COUNT	Count on event
0x3	START	Start TC on event
0x4	STAMP	Time stamp capture
0x5	PPW	Period captured in CC0, pulse width in CC1
0x6	PWP	Period captured in CC1, pulse width in CC0
0x7	PW	Pulse width capture

#### 35.7.1.5 Interrupt Enable Clear

This register allows the user to disable an interrupt without doing a read-modify-write operation. Changes in this register will also be reflected in the Interrupt Enable Set register (INTENSET).

**Name:** INTENCLR

**Offset:** 0x08 [ID-00001cd8]

**Reset:** 0x00

**Property:** PAC Write-Protection

Bit	7	6	5	4	3	2	1	0
				MCx			ERR	OVF
Access				R/W			R/W	R/W
Reset				0			0	0

### Bit 4 – MCx: Match or Capture Channel x Interrupt Enable

Writing a '0' to these bits has no effect.

Writing a '1' to MCx will clear the corresponding Match or Capture Channel x Interrupt Enable bit, which disables the Match or Capture Channel x interrupt.

Value	Description
0	The Match or Capture Channel x interrupt is disabled.
1	The Match or Capture Channel x interrupt is enabled.

**Bit 1 – ERR: Error Interrupt Disable**

Writing a '0' to this bit has no effect.

Writing a '1' to this bit will clear the Error Interrupt Enable bit, which disables the Error interrupt.

Value	Description
0	The Error interrupt is disabled.
1	The Error interrupt is enabled.

**Bit 0 – OVF: Overflow Interrupt Disable**

Writing a '0' to this bit has no effect.

Writing a '1' to this bit will clear the Overflow Interrupt Enable bit, which disables the Overflow interrupt request.

Value	Description
0	The Overflow interrupt is disabled.
1	The Overflow interrupt is enabled.

**35.7.1.6 Interrupt Enable Set**

This register allows the user to enable an interrupt without doing a read-modify-write operation. Changes in this register will also be reflected in the Interrupt Enable Clear register (INTENCLR).

**Name:** INTENSET

**Offset:** 0x09 [ID-00001cd8]

**Reset:** 0x00

**Property:** PAC Write-Protection

Bit	7	6	5	4	3	2	1	0
				MCx			ERR	OVF
Access				R/W			R/W	R/W
Reset				0			0	0

**Bit 4 – MCx: Match or Capture Channel x Interrupt Enable**

Writing a '0' to these bits has no effect.

Writing a '1' to MCx will set the corresponding Match or Capture Channel x Interrupt Enable bit, which enables the Match or Capture Channel x interrupt.

Value	Description
0	The Match or Capture Channel x interrupt is disabled.
1	The Match or Capture Channel x interrupt is enabled.

**Bit 1 – ERR: Error Interrupt Enable**

Writing a '0' to this bit has no effect.

Writing a '1' to this bit will set the Error Interrupt Enable bit, which enables the Error interrupt.

Value	Description
0	The Error interrupt is disabled.
1	The Error interrupt is enabled.

**Bit 0 – OVF: Overflow Interrupt Enable**

Writing a '0' to this bit has no effect.

Writing a '1' to this bit will set the Overflow Interrupt Enable bit, which enables the Overflow interrupt request.

Value	Description
0	The Overflow interrupt is disabled.
1	The Overflow interrupt is enabled.

### 35.7.1.7 Interrupt Flag Status and Clear

**Name:** INTFLAG

**Offset:** 0x0A [ID-00001cd8]

**Reset:** 0x00

**Property:** -

Bit	7	6	5	4	3	2	1	0
				MCx			ERR	OVF
Access				R/W			R/W	R/W
Reset				0			0	0

**Bit 4 – MCx: Match or Capture Channel x**

This flag is set on a comparison match, or when the corresponding CCx register contains a valid capture value. This flag is set on the next CLK\_TC\_CNT cycle, and will generate an interrupt request if the corresponding Match or Capture Channel x Interrupt Enable bit in the Interrupt Enable Set register (INTENSET.MCx) is '1'.

Writing a '0' to one of these bits has no effect.

Writing a '1' to one of these bits will clear the corresponding Match or Capture Channel x interrupt flag

In capture operation, this flag is automatically cleared when CCx register is read.

**Bit 1 – ERR: Error Interrupt Flag**

This flag is set when a new capture occurs on a channel while the corresponding Match or Capture Channel x interrupt flag is set, in which case there is nowhere to store the new capture.

Writing a '0' to this bit has no effect.

Writing a '1' to this bit clears the Error interrupt flag.

**Bit 0 – OVF: Overflow Interrupt Flag**

This flag is set on the next CLK\_TC\_CNT cycle after an overflow condition occurs, and will generate an interrupt request if INTENCLR.OVF or INTENSET.OVF is '1'.

Writing a '0' to this bit has no effect.

Writing a '1' to this bit clears the Overflow interrupt flag.

### 35.7.1.8 Status

**Name:** STATUS  
**Offset:** 0x0B [ID-00001cd8]  
**Reset:** 0x01  
**Property:** Read-Synchronized

	7	6	5	4	3	2	1	0	
				CCBUFVx	PERBUFV			SLAVE	STOP
Access				R/W	R/W			R	R
Reset				0	0			0	1

**Bit 4 – CCBUFVx: Channel x Compare or Capture Buffer Valid**

For a compare channel x, the bit x is set when a new value is written to the corresponding CCBUFx register.

The bit x is cleared by writing a '1' to it when CTRLB.LUPD is set, or it is cleared automatically by hardware on UPDATE condition.

For a capture channel x, the bit x is set when a valid capture value is stored in the CCBUFx register. The bit x is cleared automatically when the CCx register is read.

**Bit 3 – PERBUFV: Period Buffer Valid**

This bit is set when a new value is written to the PERBUF register. The bit is cleared by writing '1' to the corresponding location when CTRLB.LUPD is set, or automatically cleared by hardware on UPDATE condition. This bit is available only in 8-bit mode and will always read zero in 16- and 32-bit modes.

**Bit 1 – SLAVE: Slave Status Flag**

This bit is only available in 32-bit mode on the slave TC (i.e., TC1 and/or TC3). The bit is set when the associated master TC (TC0 and TC2, respectively) is set to run in 32-bit mode.

**Bit 0 – STOP: Stop Status Flag**

This bit is set when the TC is disabled, on a Stop command, or on an overflow/underflow condition when the One-Shot bit in the Control B Set register (CTRLBSET.ONESHOT) is '1'.

Value	Description
0	Counter is running.
1	Counter is stopped.

**35.7.1.9 Waveform Generation Control**

**Name:** WAVE  
**Offset:** 0x0C [ID-00001cd8]  
**Reset:** 0x00  
**Property:** PAC Write-Protection, Enable-Protected

Bit	7	6	5	4	3	2	1	0
							WAVEGEN[1:0]	
Access							R/W	R/W
Reset							0	0

### Bits 1:0 – WAVEGEN[1:0]: Waveform Generation Mode

These bits select the waveform generation operation. They affect the top value, as shown in [Waveform Output Operations](#). They also control whether frequency or PWM waveform generation should be used. The waveform generation operations are explained in [Waveform Output Operations](#).

These bits are not synchronized.

Value	Name	Operation	Top Value	Output Waveform on Match	Output Waveform on Wraparound
0x0	NFRQ	Normal frequency	PER <sup>1</sup> / Max	Toggle	No action
0x1	MFRQ	Match frequency	CC0	Toggle	No action
0x2	NPWM	Normal PWM	PER <sup>1</sup> / Max	Set	Clear
0x3	MPWM	Match PWM	CC0	Set	Clear

1) This depends on the TC mode: In 8-bit mode, the top value is the Period Value register (PER). In 16- and 32-bit mode it is the respective MAX value.

### 35.7.1.10 Driver Control

**Name:** DRVCTRL  
**Offset:** 0x0D [ID-00001cd8]  
**Reset:** 0x00  
**Property:** PAC Write-Protection, Enable-Protected

Bit	7	6	5	4	3	2	1	0
							INVENx	
Access							R/W	
Reset							0	

### Bit 0 – INVENx: Output Waveform x Invert Enable

Bit x of INVEN[1:0] selects inversion of the output or capture trigger input of channel x.

Value	Description
0	Disable inversion of the WO[x] output and IO input pin.
1	Enable inversion of the WO[x] output and IO input pin.

### 35.7.1.11 Debug Control

**Name:** DBGCTRL  
**Offset:** 0x0F [ID-00001cd8]  
**Reset:** 0x00  
**Property:** PAC Write-Protection



Bit	7	6	5	4	3	2	1	0
	[Greyed out bits]							DBGRUN
Access								R/W
Reset								0

**Bit 0 – DBGRUN: Run in Debug Mode**

This bit is not affected by a software Reset, and should not be changed by software while the TC is enabled.

Value	Description
0	The TC is halted when the device is halted in debug mode.
1	The TC continues normal operation when the device is halted in debug mode.

**35.7.1.12 Synchronization Busy**

**Name:** SYNCBUSY  
**Offset:** 0x10 [ID-00001cd8]  
**Reset:** 0x00000000  
**Property:** -

Bit	31	30	29	28	27	26	25	24
	[Greyed out bits]							
Access								
Reset								

Bit	23	22	21	20	19	18	17	16
	[Greyed out bits]							
Access								
Reset								

Bit	15	14	13	12	11	10	9	8
	[Greyed out bits]							
Access								
Reset								

Bit	7	6	5	4	3	2	1	0
	[Greyed out]	CCx	PER	COUNT	STATUS	CTRLB	ENABLE	SWRST
Access		R	R	R	R	R	R	R
Reset		0	0	0	0	0	0	0

**Bit 6 – CCx: Compare/Capture Channel x Synchronization Busy**

For details on CC channels number, refer to each TC feature list.

This bit is set when the synchronization of CCx between clock domains is started.

This bit is also set when the CCBUFx is written, and cleared on update condition. The bit is automatically cleared when the STATUS.CCBUFx bit is cleared.

**Bit 5 – PER: PER Synchronization Busy**

This bit is cleared when the synchronization of PER between the clock domains is complete.

This bit is set when the synchronization of PER between clock domains is started.

This bit is also set when the PER is written, and cleared on update condition. The bit is automatically cleared when the STATUS.PERBUF bit is cleared.

**Bit 4 – COUNT: COUNT Synchronization Busy**

This bit is cleared when the synchronization of COUNT between the clock domains is complete.

This bit is set when the synchronization of COUNT between clock domains is started.

**Bit 3 – STATUS: STATUS Synchronization Busy**

This bit is cleared when the synchronization of STATUS between the clock domains is complete.

This bit is set when a '1' is written to the Capture Channel Buffer Valid status flags (STATUS.CCBUFVx) and the synchronization of STATUS between clock domains is started.

**Bit 2 – CTRLB: CTRLB Synchronization Busy**

This bit is cleared when the synchronization of CTRLB between the clock domains is complete.

This bit is set when the synchronization of CTRLB between clock domains is started.

**Bit 1 – ENABLE: ENABLE Synchronization Busy**

This bit is cleared when the synchronization of ENABLE bit between the clock domains is complete.

This bit is set when the synchronization of ENABLE bit between clock domains is started.

**Bit 0 – SWRST: SWRST Synchronization Busy**

This bit is cleared when the synchronization of SWRST bit between the clock domains is complete.

This bit is set when the synchronization of SWRST bit between clock domains is started.

**35.7.1.13 Counter Value, 8-bit Mode**

**Note:** Prior to any read access, this register must be synchronized by user by writing the according TC Command value to the Control B Set register (CTRLBSET.CMD=READSYNC).

**Name:** COUNT

**Offset:** 0x14 [ID-00001cd8]

**Reset:** 0x00

**Property:** PAC Write-Protection, Write-Synchronized, Read-Synchronized

Bit	7	6	5	4	3	2	1	0
	COUNT[7:0]							
Access	R/W	R/W	R/W	R/W	R/W	R/W	R/W	R/W
Reset	0	0	0	0	0	0	0	0

**Bits 7:0 – COUNT[7:0]: Counter Value**

These bits contain the current counter value.

**35.7.1.14 Period Value, 8-bit Mode**

**Name:** PER

**Offset:** 0x1B [ID-00001cd8]

**Reset:** 0xFF

**Property:** Write-Synchronized

Bit	7	6	5	4	3	2	1	0
	PER[7:0]							
Access	R/W	R/W	R/W	R/W	R/W	R/W	R/W	R/W
Reset	0	0	0	0	0	0	0	1

**Bits 7:0 – PER[7:0]: Period Value**

These bits hold the value of the Period Buffer register PERBUF. The value is copied to PER register on UPDATE condition.

**35.7.1.15 Channel x Compare/Capture Value, 8-bit Mode**

**Name:** CCx  
**Offset:** 0x1C + x\*0x01 [x=0..1]  
**Reset:** 0x00  
**Property:** Write-Synchronized, Read-Synchronized

Bit	7	6	5	4	3	2	1	0
	CC[7:0]							
Access	R/W	R/W	R/W	R/W	R/W	R/W	R/W	R/W
Reset	0	0	0	0	0	0	0	0

**Bits 7:0 – CC[7:0]: Channel x Compare/Capture Value**

These bits contain the compare/capture value in 8-bit TC mode. In Match frequency (MFRQ) or Match PWM (MPWM) waveform operation (WAVE.WAVEGEN), the CC0 register is used as a period register.

**35.7.1.16 Period Buffer Value, 8-bit Mode**

**Name:** PERBUF  
**Offset:** 0x2F [ID-00001cd8]  
**Reset:** 0xFF  
**Property:** Write-Synchronized

Bit	7	6	5	4	3	2	1	0
	PERBUF[7:0]							
Access	R/W	R/W	R/W	R/W	R/W	R/W	R/W	R/W
Reset	0	0	0	0	0	0	0	1

**Bits 7:0 – PERBUF[7:0]: Period Buffer Value**

These bits hold the value of the period buffer register. The value is copied to PER register on UPDATE condition.

**35.7.1.17 Channel x Compare Buffer Value, 8-bit Mode**

**Name:** CCBUFx  
**Offset:** 0x30 + x\*0x01 [x=0..1]  
**Reset:** 0x00  
**Property:** Write-Synchronized

Bit	7	6	5	4	3	2	1	0
	CCBUF[7:0]							
Access	R/W	R/W	R/W	R/W	R/W	R/W	R/W	R/W
Reset	0	0	0	0	0	0	0	0

**Bits 7:0 – CCBUF[7:0]: Channel x Compare Buffer Value**

These bits hold the value of the Channel x Compare Buffer Value. When the buffer valid flag is '1' and double buffering is enabled (CTRLBCLR.LUPD=1), the data from buffer registers will be copied into the corresponding CCx register under UPDATE condition (CTRLBSET.CMD=0x3), including the software update command.

## 35.7.2 Register Summary - 16-bit Mode

Offset	Name	Bit Pos.									
0x00	CTRLA	7:0	ONDEMAND	RUNSTDBY	PRESCSYNC[1:0]		MODE[1:0]		ENABLE	SWRST	
0x01		15:8					ALOCK	PRESCALER[2:0]			
0x02		23:16			COPEN1	COPEN0			CAPTEN1	CAPTEN0	
0x03		31:24					CAPTMODE1[1:0]		CAPTMODE0[1:0]		
0x04	CTRLBCLR	7:0	CMD[2:0]				ONESHOT	LUPD	DIR		
0x05	CTRLBSET	7:0	CMD[2:0]				ONESHOT	LUPD	DIR		
0x06	EVCTRL	7:0		TCEI	TCINV		EVACT[2:0]				
0x07		15:8		MCEOx	MCEOx				OVFEO		
0x08	INTENCLR	7:0			MCx			ERR	OVF		
0x09	INTENSET	7:0			MCx			ERR	OVF		
0x0A	INTFLAG	7:0			MCx			ERR	OVF		
0x0B	STATUS	7:0			CCBUFVx	PERBUFV		SLAVE	STOP		
0x0C	WAVE	7:0						WAVEGEN[1:0]			
0x0D	DRVCTRL	7:0							INVENx		
0x0E	Reserved										
0x0F	DBGCTRL	7:0							DBGRUN		
0x10	SYNDBUSY	7:0		CCx	PER	COUNT	STATUS	CTRLB	ENABLE	SWRST	
0x11		15:8									
0x12		23:16									
0x13		31:24									
0x14	COUNT	7:0	COUNT[7:0]								
0x15		15:8	COUNT[15:8]								
0x16	Reserved										
...											
0x19											
0x1A	PER	7:0	PER[7:0]								
0x1B		15:8	PER[15:8]								
0x1C	CC0	7:0	CC[7:0]								
0x1D		15:8	CC[15:8]								
0x1E	CC1	7:0	CC[7:0]								
0x1F		15:8	CC[15:8]								
0x20	Reserved										
...											
0x2D											
0x2E	PERBUF	7:0	PERBUF[7:0]								
0x2F		15:8	PERBUF[15:8]								
0x30	CCBUF0	7:0	CCBUF[7:0]								
0x31		15:8	CCBUF[15:8]								
0x32	CCBUF1	7:0	CCBUF[7:0]								
0x33		15:8	CCBUF[15:8]								

### 35.7.2.1 Control A

**Name:** CTRLA  
**Offset:** 0x00 [ID-00001cd8]  
**Reset:** 0x00000000  
**Property:** PAC Write-Protection, Write-Synchronized, Enable-Protected

Bit	31	30	29	28	27	26	25	24
				CAPTMODE1[1:0]				
Access				R/W	R/W			
Reset				0	0			
Bit	23	22	21	20	19	18	17	16
			COPEN1	COPEN0			CAPTEN1	CAPTEN0
Access			R/W	R/W			R/W	R/W
Reset			0	0			0	0
Bit	15	14	13	12	11	10	9	8
					ALOCK			
Access					R/W	R/W	R/W	R/W
Reset					0	0	0	0
Bit	7	6	5	4	3	2	1	0
	ONDEMAND	RUNSTDBY	PRESCSYNC[1:0]		MODE[1:0]		ENABLE	SWRST
Access	R/W	R/W	R/W	R/W	R/W	R/W	R/W	W
Reset	0	0	0	0	0	0	0	0

**Bits 28:27 – CAPTMODE1[1:0]: Capture mode Channel 1**

These bits select the channel 1 capture mode.

Value	Name	Description
0x0	DEFAULT	Default capture
0x1	CAPTMIN	Minimum capture
0x2	CAPTMAX	Maximum capture
0x3		Reserved

**Bits 25:24 – CAPTMODE0[1:0]: Capture mode Channel 0**

These bits select the channel 0 capture mode.

Value	Name	Description
0x0	DEFAULT	Default capture
0x1	CAPTMIN	Minimum capture
0x2	CAPTMAX	Maximum capture
0x3		Reserved

**Bits 20, 21 – COPENx: Capture On Pin x Enable**

Bit x of COPEN[1:0] selects the trigger source for capture operation, either events or I/O pin input.

Value	Description
0	Event from Event System is selected as trigger source for capture operation on channel x.
1	I/O pin is selected as trigger source for capture operation on channel x.

## Bits 16, 17 – CAPTENx: Capture Channel x Enable

Bit x of CAPTEN[1:0] selects whether channel x is a capture or a compare channel.

These bits are not synchronized.

Value	Description
0	CAPTEN disables capture on channel x.
1	CAPTEN enables capture on channel x.

## Bit 11 – ALOCK: Auto Lock

When this bit is set, Lock bit update (LUPD) is set to '1' on each overflow/underflow or re-trigger event.

This bit is not synchronized.

Value	Description
0	The LUPD bit is not affected on overflow/underflow, and re-trigger event.
1	The LUPD bit is set on each overflow/underflow or re-trigger event.

## Bits 10:8 – PRESCALER[2:0]: Prescaler

These bits select the counter prescaler factor.

These bits are not synchronized.

Value	Name	Description
0x0	DIV1	Prescaler: GCLK_TC
0x1	DIV2	Prescaler: GCLK_TC/2
0x2	DIV4	Prescaler: GCLK_TC/4
0x3	DIV8	Prescaler: GCLK_TC/8
0x4	DIV16	Prescaler: GCLK_TC/16
0x5	DIV64	Prescaler: GCLK_TC/64
0x6	DIV256	Prescaler: GCLK_TC/256
0x7	DIV1024	Prescaler: GCLK_TC/1024

## Bit 7 – ONDEMAND: Clock On Demand

This bit selects the clock requirements when the TC is stopped.

In standby mode, if the Run in Standby bit (CTRLA.RUNSTDBY) is '0', ONDEMAND is forced to '0'.

This bit is not synchronized.

Value	Description
0	The On Demand is disabled. If On Demand is disabled, the TC will continue to request the clock when its operation is stopped (STATUS.STOP=1).
1	The On Demand is enabled. When On Demand is enabled, the stopped TC will not request the clock. The clock is requested when a software re-trigger command is applied or when an event with start/re-trigger action is detected.

## Bit 6 – RUNSTDBY: Run in Standby

This bit is used to keep the TC running in standby mode.

This bit is not synchronized.

Value	Description
0	The TC is halted in standby.
1	The TC continues to run in standby.

## Bits 5:4 – PRESCSYNC[1:0]: Prescaler and Counter Synchronization

These bits select whether the counter should wrap around on the next GCLK\_TCx clock or the next prescaled GCLK\_TCx clock. It also makes it possible to reset the prescaler.

These bits are not synchronized.

Value	Name	Description
0x0	GCLK	Reload or reset the counter on next generic clock
0x1	PRESC	Reload or reset the counter on next prescaler clock
0x2	RESYNC	Reload or reset the counter on next generic clock. Reset the prescaler counter
0x3	-	Reserved

## Bits 3:2 – MODE[1:0]: Timer Counter Mode

These bits select the counter mode.

These bits are not synchronized.

Value	Name	Description
0x0	COUNT16	Counter in 16-bit mode
0x1	COUNT8	Counter in 8-bit mode
0x2	COUNT32	Counter in 32-bit mode
0x3	-	Reserved

## Bit 1 – ENABLE: Enable

Due to synchronization, there is delay from writing CTRLA.ENABLE until the peripheral is enabled/disabled. The value written to CTRLA.ENABLE will read back immediately, and the ENABLE Synchronization Busy bit in the SYNCBUSY register (SYNCBUSY.ENABLE) will be set. SYNCBUSY.ENABLE will be cleared when the operation is complete.

This bit is not enable protected.

Value	Description
0	The peripheral is disabled.
1	The peripheral is enabled.

## Bit 0 – SWRST: Software Reset

Writing a '0' to this bit has no effect.

Writing a '1' to this bit resets all registers in the TC, except DBGCTRL, to their initial state, and the TC will be disabled.

Writing a '1' to CTRLA.SWRST will always take precedence; all other writes in the same write-operation will be discarded.

Due to synchronization there is a delay from writing CTRLA.SWRST until the reset is complete. CTRLA.SWRST and SYNCBUSY.SWRST will both be cleared when the reset is complete.

This bit is not enable protected.

Value	Description
0	There is no reset operation ongoing.
1	The reset operation is ongoing.

### 35.7.2.2 Control B Clear

This register allows the user to clear bits in the CTRLB register without doing a read-modify-write operation. Changes in this register will also be reflected in the Control B Set register (CTRLBSET).



**Name:** CTRLBCLR  
**Offset:** 0x04 [ID-00001cd8]  
**Reset:** 0x00  
**Property:** PAC Write-Protection, Read-Synchronized, Write-Synchronized

Bit	7	6	5	4	3	2	1	0
	CMD[2:0]					ONESHOT	LUPD	DIR
Access	R/W	R/W	R/W			R/W	R/W	R/W
Reset	0	0	0			0	0	0

**Bits 7:5 – CMD[2:0]: Command**

These bits are used for software control of the TC. The commands are executed on the next prescaled GCLK\_TC clock cycle. When a command has been executed, the CMD bit group will be read back as zero.

Writing 0x0 to these bits has no effect.

Writing a '1' to any of these bits will clear the pending command.

**Bit 2 – ONESHOT: One-Shot on Counter**

This bit controls one-shot operation of the TC.

Writing a '0' to this bit has no effect

Writing a '1' to this bit will disable one-shot operation.

Value	Description
0	The TC will wrap around and continue counting on an overflow/underflow condition.
1	The TC will wrap around and stop on the next underflow/overflow condition.

**Bit 1 – LUPD: Lock Update**

This bit controls the update operation of the TC buffered registers.

When CTRLB.LUPD is set, no any update of the registers with value of its buffered register is performed on hardware UPDATE condition. Locking the update ensures that all buffer registers are valid before an hardware update is performed. After all the buffer registers are loaded correctly, the buffered registers can be unlocked.

This bit has no effect when input capture operation is enabled.

Writing a '0' to this bit has no effect.

Writing a '1' to this bit will clear the LUPD bit.

Value	Description
0	The CCBUFx and PERBUF buffer registers value are copied into CCx and PER registers on hardware update condition.
1	The CCBUFx and PERBUF buffer registers value are not copied into CCx and PER registers on hardware update condition.

**Bit 0 – DIR: Counter Direction**

This bit is used to change the direction of the counter.

Writing a '0' to this bit has no effect.

Writing a '1' to this bit will clear the bit and make the counter count up.

Value	Description
0	The timer/counter is counting up (incrementing).
1	The timer/counter is counting down (decrementing).

### 35.7.2.3 Control B Set

This register allows the user to set bits in the CTRLB register without doing a read-modify-write operation. Changes in this register will also be reflected in the Control B Clear register (CTRLBCLR).

**Name:** CTRLBSET

**Offset:** 0x05 [ID-00001cd8]

**Reset:** 0x00

**Property:** PAC Write-Protection, Read-synchronized, Write-Synchronized

Bit	7	6	5	4	3	2	1	0
	CMD[2:0]					ONESHOT	LUPD	DIR
Access	R/W	R/W	R/W			R/W	R/W	R/W
Reset	0	0	0			0	0	0

#### Bits 7:5 – CMD[2:0]: Command

These bits are used for software control of the TC. The commands are executed on the next prescaled GCLK\_TC clock cycle. When a command has been executed, the CMD bit group will be read back as zero.

Writing 0x0 to these bits has no effect.

Writing a value different from 0x0 to these bits will issue a command for execution.

Value	Name	Description
0x0	NONE	No action
0x1	RETRIGGER	Force a start, restart or retrigger
0x2	STOP	Force a stop
0x3	UPDATE	Force update of double buffered registers
0x4	READSYNC	Force a read synchronization of COUNT

#### Bit 2 – ONESHOT: One-Shot on Counter

This bit controls one-shot operation of the TC.

Writing a '0' to this bit has no effect.

Writing a '1' to this bit will enable one-shot operation.

Value	Description
0	The TC will wrap around and continue counting on an overflow/underflow condition.
1	The TC will wrap around and stop on the next underflow/overflow condition.

#### Bit 1 – LUPD: Lock Update

This bit controls the update operation of the TC buffered registers.

When CTRLB.LUPD is set, no any update of the registers with value of its buffered register is performed on hardware UPDATE condition. Locking the update ensures that all buffer registers are valid before an hardware update is performed. After all the buffer registers are loaded correctly, the buffered registers can be unlocked.

Writing a '0' to this bit has no effect.

Writing a '1' to this bit will set the LUPD bit.

This bit has no effect when input capture operation is enabled.

Value	Description
0	The CCBUFx and PERBUF buffer registers value are copied into CCx and PER registers on hardware update condition.
1	The CCBUFx and PERBUF buffer registers value are not copied into CCx and PER registers on hardware update condition.

### Bit 0 – DIR: Counter Direction

This bit is used to change the direction of the counter.

Writing a '0' to this bit has no effect

Writing a '1' to this bit will clear the bit and make the counter count up.

Value	Description
0	The timer/counter is counting up (incrementing).
1	The timer/counter is counting down (decrementing).

## 35.7.2.4 Event Control

**Name:** EVCTRL

**Offset:** 0x06 [ID-00001cd8]

**Reset:** 0x0000

**Property:** PAC Write-Protection, Enable-Protected

Bit	15	14	13	12	11	10	9	8
			MCEOx	MCEOx				OVFEO
Access			R/W	R/W				R/W
Reset			0	0				0
Bit	7	6	5	4	3	2	1	0
			TCEI	TCINV		EVACT[2:0]		
Access			R/W	R/W		R/W	R/W	R/W
Reset			0	0		0	0	0

### Bits 13,12 – MCEOx: Match or Capture Channel x Event Output Enable [x = 1..0]

These bits enable the generation of an event for every match or capture on channel x.

Value	Description
0	Match/Capture event on channel x is disabled and will not be generated.
1	Match/Capture event on channel x is enabled and will be generated for every compare/capture.

### Bit 8 – OVFEO: Overflow/Underflow Event Output Enable

This bit enables the Overflow/Underflow event. When enabled, an event will be generated when the counter overflows/underflows.

Value	Description
0	Overflow/Underflow event is disabled and will not be generated.
1	Overflow/Underflow event is enabled and will be generated for every counter overflow/underflow.

### Bit 5 – TCEI: TC Event Enable

This bit is used to enable asynchronous input events to the TC.

Value	Description
0	Incoming events are disabled.
1	Incoming events are enabled.

### Bit 4 – TCINV: TC Inverted Event Input Polarity

This bit inverts the asynchronous input event source.

Value	Description
0	Input event source is not inverted.
1	Input event source is inverted.

### Bits 2:0 – EVACT[2:0]: Event Action

These bits define the event action the TC will perform on an event.

Value	Name	Description
0x0	OFF	Event action disabled
0x1	RETRIGGER	Start, restart or retrigger TC on event
0x2	COUNT	Count on event
0x3	START	Start TC on event
0x4	STAMP	Time stamp capture
0x5	PPW	Period captured in CC0, pulse width in CC1
0x6	PWP	Period captured in CC1, pulse width in CC0
0x7	PW	Pulse width capture

#### 35.7.2.5 Interrupt Enable Clear

This register allows the user to disable an interrupt without doing a read-modify-write operation. Changes in this register will also be reflected in the Interrupt Enable Set register (INTENSET).

**Name:** INTENCLR

**Offset:** 0x08 [ID-00001cd8]

**Reset:** 0x00

**Property:** PAC Write-Protection

Bit	7	6	5	4	3	2	1	0
				MCx			ERR	OVF
Access				R/W			R/W	R/W
Reset				0			0	0

### Bit 4 – MCx: Match or Capture Channel x Interrupt Enable

Writing a '0' to these bits has no effect.

Writing a '1' to MCx will clear the corresponding Match or Capture Channel x Interrupt Enable bit, which disables the Match or Capture Channel x interrupt.

Value	Description
0	The Match or Capture Channel x interrupt is disabled.
1	The Match or Capture Channel x interrupt is enabled.

**Bit 1 – ERR: Error Interrupt Disable**

Writing a '0' to this bit has no effect.

Writing a '1' to this bit will clear the Error Interrupt Enable bit, which disables the Error interrupt.

Value	Description
0	The Error interrupt is disabled.
1	The Error interrupt is enabled.

**Bit 0 – OVF: Overflow Interrupt Disable**

Writing a '0' to this bit has no effect.

Writing a '1' to this bit will clear the Overflow Interrupt Enable bit, which disables the Overflow interrupt request.

Value	Description
0	The Overflow interrupt is disabled.
1	The Overflow interrupt is enabled.

**35.7.2.6 Interrupt Enable Set**

This register allows the user to enable an interrupt without doing a read-modify-write operation. Changes in this register will also be reflected in the Interrupt Enable Clear register (INTENCLR).

**Name:** INTENSET

**Offset:** 0x09 [ID-00001cd8]

**Reset:** 0x00

**Property:** PAC Write-Protection

Bit	7	6	5	4	3	2	1	0
				MCx			ERR	OVF
Access				R/W			R/W	R/W
Reset				0			0	0

**Bit 4 – MCx: Match or Capture Channel x Interrupt Enable**

Writing a '0' to these bits has no effect.

Writing a '1' to MCx will set the corresponding Match or Capture Channel x Interrupt Enable bit, which enables the Match or Capture Channel x interrupt.

Value	Description
0	The Match or Capture Channel x interrupt is disabled.
1	The Match or Capture Channel x interrupt is enabled.

**Bit 1 – ERR: Error Interrupt Enable**

Writing a '0' to this bit has no effect.

Writing a '1' to this bit will set the Error Interrupt Enable bit, which enables the Error interrupt.

Value	Description
0	The Error interrupt is disabled.
1	The Error interrupt is enabled.

**Bit 0 – OVF: Overflow Interrupt Enable**

Writing a '0' to this bit has no effect.

Writing a '1' to this bit will set the Overflow Interrupt Enable bit, which enables the Overflow interrupt request.

Value	Description
0	The Overflow interrupt is disabled.
1	The Overflow interrupt is enabled.

### 35.7.2.7 Interrupt Flag Status and Clear

**Name:** INTFLAG

**Offset:** 0x0A [ID-00001cd8]

**Reset:** 0x00

**Property:** -

	7	6	5	4	3	2	1	0
				MCx			ERR	OVF
Access				R/W			R/W	R/W
Reset				0			0	0

**Bit 4 – MCx: Match or Capture Channel x**

This flag is set on a comparison match, or when the corresponding CCx register contains a valid capture value. This flag is set on the next CLK\_TC\_CNT cycle, and will generate an interrupt request if the corresponding Match or Capture Channel x Interrupt Enable bit in the Interrupt Enable Set register (INTENSET.MCx) is '1'.

Writing a '0' to one of these bits has no effect.

Writing a '1' to one of these bits will clear the corresponding Match or Capture Channel x interrupt flag

In capture operation, this flag is automatically cleared when CCx register is read.

**Bit 1 – ERR: Error Interrupt Flag**

This flag is set when a new capture occurs on a channel while the corresponding Match or Capture Channel x interrupt flag is set, in which case there is nowhere to store the new capture.

Writing a '0' to this bit has no effect.

Writing a '1' to this bit clears the Error interrupt flag.

**Bit 0 – OVF: Overflow Interrupt Flag**

This flag is set on the next CLK\_TC\_CNT cycle after an overflow condition occurs, and will generate an interrupt request if INTENCLR.OVF or INTENSET.OVF is '1'.

Writing a '0' to this bit has no effect.

Writing a '1' to this bit clears the Overflow interrupt flag.

### 35.7.2.8 Status

**Name:** STATUS  
**Offset:** 0x0B [ID-00001cd8]  
**Reset:** 0x01  
**Property:** Read-Synchronized

Bit	7	6	5	4	3	2	1	0
				CCBUFVx	PERBUFV		SLAVE	STOP
Access				R/W	R/W		R	R
Reset				0	0		0	1

**Bit 4 – CCBUFVx: Channel x Compare or Capture Buffer Valid**

For a compare channel x, the bit x is set when a new value is written to the corresponding CCBUFx register.

The bit x is cleared by writing a '1' to it when CTRLB.LUPD is set, or it is cleared automatically by hardware on UPDATE condition.

For a capture channel x, the bit x is set when a valid capture value is stored in the CCBUFx register. The bit x is cleared automatically when the CCx register is read.

**Bit 3 – PERBUFV: Period Buffer Valid**

This bit is set when a new value is written to the PERBUF register. The bit is cleared by writing '1' to the corresponding location when CTRLB.LUPD is set, or automatically cleared by hardware on UPDATE condition. This bit is available only in 8-bit mode and will always read zero in 16- and 32-bit modes.

**Bit 1 – SLAVE: Slave Status Flag**

This bit is only available in 32-bit mode on the slave TC (i.e., TC1 and/or TC3). The bit is set when the associated master TC (TC0 and TC2, respectively) is set to run in 32-bit mode.

**Bit 0 – STOP: Stop Status Flag**

This bit is set when the TC is disabled, on a Stop command, or on an overflow/underflow condition when the One-Shot bit in the Control B Set register (CTRLBSET.ONESHOT) is '1'.

Value	Description
0	Counter is running.
1	Counter is stopped.

**35.7.2.9 Waveform Generation Control**

**Name:** WAVE  
**Offset:** 0x0C [ID-00001cd8]  
**Reset:** 0x00  
**Property:** PAC Write-Protection, Enable-Protected

Bit	7	6	5	4	3	2	1	0
							WAVEGEN[1:0]	
Access							R/W	R/W
Reset							0	0

### Bits 1:0 – WAVEGEN[1:0]: Waveform Generation Mode

These bits select the waveform generation operation. They affect the top value, as shown in [Waveform Output Operations](#). They also control whether frequency or PWM waveform generation should be used. The waveform generation operations are explained in [Waveform Output Operations](#).

These bits are not synchronized.

Value	Name	Operation	Top Value	Output Waveform on Match	Output Waveform on Wraparound
0x0	NFRQ	Normal frequency	PER <sup>1</sup> / Max	Toggle	No action
0x1	MFRQ	Match frequency	CC0	Toggle	No action
0x2	NPWM	Normal PWM	PER <sup>1</sup> / Max	Set	Clear
0x3	MPWM	Match PWM	CC0	Set	Clear

1) This depends on the TC mode: In 8-bit mode, the top value is the Period Value register (PER). In 16- and 32-bit mode it is the respective MAX value.

### 35.7.2.10 Driver Control

**Name:** DRVCTRL  
**Offset:** 0x0D [ID-00001cd8]  
**Reset:** 0x00  
**Property:** PAC Write-Protection, Enable-Protected

Bit	7	6	5	4	3	2	1	0
							INVENx	
Access							R/W	
Reset							0	

### Bit 0 – INVENx: Output Waveform x Invert Enable

Bit x of INVEN[1:0] selects inversion of the output or capture trigger input of channel x.

Value	Description
0	Disable inversion of the WO[x] output and IO input pin.
1	Enable inversion of the WO[x] output and IO input pin.

### 35.7.2.11 Debug Control

**Name:** DBGCTRL  
**Offset:** 0x0F [ID-00001cd8]  
**Reset:** 0x00  
**Property:** PAC Write-Protection



Bit	7	6	5	4	3	2	1	0
								DBGRUN
Access								R/W
Reset								0

**Bit 0 – DBGRUN: Run in Debug Mode**

This bit is not affected by a software Reset, and should not be changed by software while the TC is enabled.

Value	Description
0	The TC is halted when the device is halted in debug mode.
1	The TC continues normal operation when the device is halted in debug mode.

### 35.7.2.12 Synchronization Busy

**Name:** SYNCBUSY  
**Offset:** 0x10 [ID-00001cd8]  
**Reset:** 0x00000000  
**Property:** -

Bit	31	30	29	28	27	26	25	24
Access								
Reset								

Bit	23	22	21	20	19	18	17	16
Access								
Reset								

Bit	15	14	13	12	11	10	9	8
Access								
Reset								

Bit	7	6	5	4	3	2	1	0
		CCx	PER	COUNT	STATUS	CTRLB	ENABLE	SWRST
Access		R	R	R	R	R	R	R
Reset		0	0	0	0	0	0	0

**Bit 6 – CCx: Compare/Capture Channel x Synchronization Busy**

For details on CC channels number, refer to each TC feature list.

This bit is set when the synchronization of CCx between clock domains is started.

This bit is also set when the CCBUFx is written, and cleared on update condition. The bit is automatically cleared when the STATUS.CCBUFx bit is cleared.

**Bit 5 – PER: PER Synchronization Busy**

This bit is cleared when the synchronization of PER between the clock domains is complete.

This bit is set when the synchronization of PER between clock domains is started.

This bit is also set when the PER is written, and cleared on update condition. The bit is automatically cleared when the STATUS.PERBUF bit is cleared.

**Bit 4 – COUNT: COUNT Synchronization Busy**

This bit is cleared when the synchronization of COUNT between the clock domains is complete.

This bit is set when the synchronization of COUNT between clock domains is started.

**Bit 3 – STATUS: STATUS Synchronization Busy**

This bit is cleared when the synchronization of STATUS between the clock domains is complete.

This bit is set when a '1' is written to the Capture Channel Buffer Valid status flags (STATUS.CCBUFVx) and the synchronization of STATUS between clock domains is started.

**Bit 2 – CTRLB: CTRLB Synchronization Busy**

This bit is cleared when the synchronization of CTRLB between the clock domains is complete.

This bit is set when the synchronization of CTRLB between clock domains is started.

**Bit 1 – ENABLE: ENABLE Synchronization Busy**

This bit is cleared when the synchronization of ENABLE bit between the clock domains is complete.

This bit is set when the synchronization of ENABLE bit between clock domains is started.

**Bit 0 – SWRST: SWRST Synchronization Busy**

This bit is cleared when the synchronization of SWRST bit between the clock domains is complete.

This bit is set when the synchronization of SWRST bit between clock domains is started.

**35.7.2.13 Counter Value, 16-bit Mode**

**Note:** Prior to any read access, this register must be synchronized by user by writing the according TC Command value to the Control B Set register (CTRLBSET.CMD=READSYNC).

**Name:** COUNT

**Offset:** 0x14 [ID-00001cd8]

**Reset:** 0x00

**Property:** PAC Write-Protection, Write-Synchronized, Read-Synchronized

Bit	15	14	13	12	11	10	9	8
	COUNT[15:8]							
Access	R/W	R/W	R/W	R/W	R/W	R/W	R/W	R/W
Reset	0	0	0	0	0	0	0	0
Bit	7	6	5	4	3	2	1	0
	COUNT[7:0]							
Access	R/W	R/W	R/W	R/W	R/W	R/W	R/W	R/W
Reset	0	0	0	0	0	0	0	0

**Bits 15:0 – COUNT[15:0]: Counter Value**

These bits contain the current counter value.

**35.7.2.14 Period Value, 16-bit Mode**

**Name:** PER  
**Offset:** 0x1A [ID-00001cd8]  
**Reset:** 0xFFFF  
**Property:** Write-Synchronized

Bit	15	14	13	12	11	10	9	8
	PER[15:8]							
Access	R/W	R/W	R/W	R/W	R/W	R/W	R/W	R/W
Reset	0	0	0	0	0	0	0	0
Bit	7	6	5	4	3	2	1	0
	PER[7:0]							
Access	R/W	R/W	R/W	R/W	R/W	R/W	R/W	R/W
Reset	0	0	0	0	0	0	0	1

**Bits 15:0 – PER[15:0]: Period Value**

These bits hold the value of the Period Buffer register PERBUF. The value is copied to PER register on UPDATE condition.

**35.7.2.15 Channel x Compare/Capture Value, 16-bit Mode**

**Name:** CCx  
**Offset:** 0x1C + x\*0x02 [x=0..1]  
**Reset:** 0x0000  
**Property:** Write-Synchronized

Bit	15	14	13	12	11	10	9	8
	CC[15:8]							
Access	R/W	R/W	R/W	R/W	R/W	R/W	R/W	R/W
Reset	0	0	0	0	0	0	0	0
Bit	7	6	5	4	3	2	1	0
	CC[7:0]							
Access	R/W	R/W	R/W	R/W	R/W	R/W	R/W	R/W
Reset	0	0	0	0	0	0	0	0

**Bits 15:0 – CC[15:0]: Channel x Compare/Capture Value**

These bits contain the compare/capture value in 16-bit TC mode. In Match frequency (MFRQ) or Match PWM (MPWM) waveform operation (WAVE.WAVEGEN), the CC0 register is used as a period register.

**35.7.2.16 Period Buffer Value, 16-bit Mode**

**Name:** PERBUF  
**Offset:** 0x2E [ID-00001cd8]  
**Reset:** 0xFFFF  
**Property:** Write-Synchronized

Bit	15	14	13	12	11	10	9	8
	PERBUF[15:8]							
Access	R/W	R/W	R/W	R/W	R/W	R/W	R/W	R/W
Reset	0	0	0	0	0	0	0	0
Bit	7	6	5	4	3	2	1	0
	PERBUF[7:0]							
Access	R/W	R/W	R/W	R/W	R/W	R/W	R/W	R/W
Reset	0	0	0	0	0	0	0	1

**Bits 15:0 – PERBUF[15:0]: Period Buffer Value**

These bits hold the value of the period buffer register. The value is copied to PER register on UPDATE condition.

**35.7.2.17 Channel x Compare Buffer Value, 16-bit Mode**

**Name:** CCBUFx  
**Offset:** 0x30 + x\*0x02 [x=0..1]  
**Reset:** 0x0000  
**Property:** Write-Synchronized

Bit	15	14	13	12	11	10	9	8
	CCBUF[15:8]							
Access	R/W	R/W	R/W	R/W	R/W	R/W	R/W	R/W
Reset	0	0	0	0	0	0	0	0
Bit	7	6	5	4	3	2	1	0
	CCBUF[7:0]							
Access	R/W	R/W	R/W	R/W	R/W	R/W	R/W	R/W
Reset	0	0	0	0	0	0	0	0

**Bits 15:0 – CCBUF[15:0]: Channel x Compare Buffer Value**

These bits hold the value of the Channel x Compare Buffer Value. When the buffer valid flag is '1' and double buffering is enabled (CTRLBCLR.LUPD=1), the data from buffer registers will be copied into the corresponding CCx register under UPDATE condition (CTRLBSET.CMD=0x3), including the software update command.

## 35.7.3 Register Summary - 32-bit Mode

Offset	Name	Bit Pos.								
0x00	CTRLA	7:0	ONDEMAND	RUNSTDBY	PRESCSYNC[1:0]		MODE[1:0]		ENABLE	SWRST
0x01		15:8					ALOCK	PRESCALER[2:0]		
0x02		23:16			COPEN1	COPEN0			CAPTEN1	CAPTEN0
0x03		31:24					CAPTMODE1[1:0]		CAPTMODE0[1:0]	
0x04	CTRLBCLR	7:0	CMD[2:0]				ONESHOT	LUPD	DIR	
0x05	CTRLBSET	7:0	CMD[2:0]				ONESHOT	LUPD	DIR	
0x06	EVCTRL	7:0		TCEI	TCINV		EVACT[2:0]			
0x07		15:8		MCEOx	MCEOx				OVFEO	
0x08	INTENCLR	7:0			MCx			ERR	OVF	
0x09	INTENSET	7:0			MCx			ERR	OVF	
0x0A	INTFLAG	7:0			MCx			ERR	OVF	
0x0B	STATUS	7:0			CCBUFVx	PERBUFV		SLAVE	STOP	
0x0C	WAVE	7:0						WAVEGEN[1:0]		
0x0D	DRVCTRL	7:0							INVENx	
0x0E	Reserved									
0x0F	DBGCTRL	7:0							DBGGRUN	
0x10	SYNDBUSY	7:0		CCx	PER	COUNT	STATUS	CTRLB	ENABLE	SWRST
0x11		15:8								
0x12		23:16								
0x13		31:24								
0x14	COUNT	7:0	COUNT[7:0]							
0x15		15:8	COUNT[15:8]							
0x16		23:16	COUNT[23:16]							
0x17		31:24	COUNT[31:24]							
0x18	Reserved									
0x19										
0x1A	PER	7:0	PER[7:0]							
0x1B		15:8	PER[15:8]							
0x1C		23:16	PER[23:16]							
0x1D		31:24	PER[31:24]							
0x1C	CC0	7:0	CC[7:0]							
0x1D		15:8	CC[15:8]							
0x1E		23:16	CC[23:16]							
0x1F		31:24	CC[31:24]							
0x20	CC1	7:0	CC[7:0]							
0x21		15:8	CC[15:8]							
0x22		23:16	CC[23:16]							
0x23		31:24	CC[31:24]							
0x26	Reserved									
0x2B										
0x2C	PERBUF	7:0	PERBUF[7:0]							
0x2D		15:8	PERBUF[15:8]							
0x2E		23:16	PERBUF[23:16]							

Offset	Name	Bit Pos.							
0x2F		31:24							PERBUF[31:24]
0x30	CCBUF0	7:0							CCBUF[7:0]
0x31		15:8							CCBUF[15:8]
0x32		23:16							CCBUF[23:16]
0x33		31:24							CCBUF[31:24]
0x34		CCBUF1	7:0						
0x35	15:8								CCBUF[15:8]
0x36	23:16								CCBUF[23:16]
0x37	31:24								CCBUF[31:24]

### 35.7.3.1 Control A

**Name:** CTRLA

**Offset:** 0x00 [ID-00001cd8]

**Reset:** 0x00000000

**Property:** PAC Write-Protection, Write-Synchronized, Enable-Protected

Bit	31	30	29	28	27	26	25	24
			CAPTMODE1[1:0]				CAPTMODE0[1:0]	
Access				R/W	R/W		R/W	R/W
Reset				0	0		0	0
Bit	23	22	21	20	19	18	17	16
			COPEN1	COPEN0			CAPTEN1	CAPTEN0
Access			R/W	R/W			R/W	R/W
Reset			0	0			0	0
Bit	15	14	13	12	11	10	9	8
					ALOCK	PRESCALER[2:0]		
Access					R/W	R/W	R/W	R/W
Reset					0	0	0	0
Bit	7	6	5	4	3	2	1	0
	ONDEMAND	RUNSTDBY	PRESCSYNC[1:0]		MODE[1:0]		ENABLE	SWRST
Access	R/W	R/W	R/W	R/W	R/W	R/W	R/W	W
Reset	0	0	0	0	0	0	0	0

#### Bits 28:27 – CAPTMODE1[1:0]: Capture mode Channel 1

These bits select the channel 1 capture mode.

Value	Name	Description
0x0	DEFAULT	Default capture
0x1	CAPTMIN	Minimum capture
0x2	CAPTMAX	Maximum capture
0x3		Reserved

#### Bits 25:24 – CAPTMODE0[1:0]: Capture mode Channel 0

These bits select the channel 0 capture mode.

Value	Name	Description
0x0	DEFAULT	Default capture
0x1	CAPTMIN	Minimum capture
0x2	CAPTMAX	Maximum capture
0x3		Reserved

### Bits 20, 21 – COPENx: Capture On Pin x Enable

Bit x of COPEN[1:0] selects the trigger source for capture operation, either events or I/O pin input.

Value	Description
0	Event from Event System is selected as trigger source for capture operation on channel x.
1	I/O pin is selected as trigger source for capture operation on channel x.

### Bits 16, 17 – CAPTENx: Capture Channel x Enable

Bit x of CAPTEN[1:0] selects whether channel x is a capture or a compare channel.

These bits are not synchronized.

Value	Description
0	CAPTEN disables capture on channel x.
1	CAPTEN enables capture on channel x.

### Bit 11 – ALOCK: Auto Lock

When this bit is set, Lock bit update (LUPD) is set to '1' on each overflow/underflow or re-trigger event.

This bit is not synchronized.

Value	Description
0	The LUPD bit is not affected on overflow/underflow, and re-trigger event.
1	The LUPD bit is set on each overflow/underflow or re-trigger event.

### Bits 10:8 – PRESCALER[2:0]: Prescaler

These bits select the counter prescaler factor.

These bits are not synchronized.

Value	Name	Description
0x0	DIV1	Prescaler: GCLK_TC
0x1	DIV2	Prescaler: GCLK_TC/2
0x2	DIV4	Prescaler: GCLK_TC/4
0x3	DIV8	Prescaler: GCLK_TC/8
0x4	DIV16	Prescaler: GCLK_TC/16
0x5	DIV64	Prescaler: GCLK_TC/64
0x6	DIV256	Prescaler: GCLK_TC/256
0x7	DIV1024	Prescaler: GCLK_TC/1024

### Bit 7 – ONDEMAND: Clock On Demand

This bit selects the clock requirements when the TC is stopped.

In standby mode, if the Run in Standby bit (CTRLA.RUNSTDBY) is '0', ONDEMAND is forced to '0'.

This bit is not synchronized.

Value	Description
0	The On Demand is disabled. If On Demand is disabled, the TC will continue to request the clock when its operation is stopped (STATUS.STOP=1).
1	The On Demand is enabled. When On Demand is enabled, the stopped TC will not request the clock. The clock is requested when a software re-trigger command is applied or when an event with start/re-trigger action is detected.

### Bit 6 – RUNSTDBY: Run in Standby

This bit is used to keep the TC running in standby mode.

This bit is not synchronized.

Value	Description
0	The TC is halted in standby.
1	The TC continues to run in standby.

### Bits 5:4 – PRESCSYNC[1:0]: Prescaler and Counter Synchronization

These bits select whether the counter should wrap around on the next GCLK\_TCx clock or the next prescaled GCLK\_TCx clock. It also makes it possible to reset the prescaler.

These bits are not synchronized.

Value	Name	Description
0x0	GCLK	Reload or reset the counter on next generic clock
0x1	PRESC	Reload or reset the counter on next prescaler clock
0x2	RESYNC	Reload or reset the counter on next generic clock. Reset the prescaler counter
0x3	-	Reserved

### Bits 3:2 – MODE[1:0]: Timer Counter Mode

These bits select the counter mode.

These bits are not synchronized.

Value	Name	Description
0x0	COUNT16	Counter in 16-bit mode
0x1	COUNT8	Counter in 8-bit mode
0x2	COUNT32	Counter in 32-bit mode
0x3	-	Reserved

### Bit 1 – ENABLE: Enable

Due to synchronization, there is delay from writing CTRLA.ENABLE until the peripheral is enabled/disabled. The value written to CTRLA.ENABLE will read back immediately, and the ENABLE Synchronization Busy bit in the SYNCBUSY register (SYNCBUSY.ENABLE) will be set. SYNCBUSY.ENABLE will be cleared when the operation is complete.

This bit is not enable protected.

Value	Description
0	The peripheral is disabled.
1	The peripheral is enabled.

### Bit 0 – SWRST: Software Reset

Writing a '0' to this bit has no effect.



Writing a '1' to this bit resets all registers in the TC, except DBGCTRL, to their initial state, and the TC will be disabled.

Writing a '1' to CTRLA.SWRST will always take precedence; all other writes in the same write-operation will be discarded.

Due to synchronization there is a delay from writing CTRLA.SWRST until the reset is complete. CTRLA.SWRST and SYNCBUSY.SWRST will both be cleared when the reset is complete.

This bit is not enable protected.

Value	Description
0	There is no reset operation ongoing.
1	The reset operation is ongoing.

### 35.7.3.2 Control B Clear

This register allows the user to clear bits in the CTRLB register without doing a read-modify-write operation. Changes in this register will also be reflected in the Control B Set register (CTRLBSET).

**Name:** CTRLBCLR

**Offset:** 0x04 [ID-00001cd8]

**Reset:** 0x00

**Property:** PAC Write-Protection, Read-Synchronized, Write-Synchronized

Bit	7	6	5	4	3	2	1	0
	CMD[2:0]					ONESHOT	LUPD	DIR
Access	R/W	R/W	R/W			R/W	R/W	R/W
Reset	0	0	0			0	0	0

#### Bits 7:5 – CMD[2:0]: Command

These bits are used for software control of the TC. The commands are executed on the next prescaled GCLK\_TC clock cycle. When a command has been executed, the CMD bit group will be read back as zero.

Writing 0x0 to these bits has no effect.

Writing a '1' to any of these bits will clear the pending command.

#### Bit 2 – ONESHOT: One-Shot on Counter

This bit controls one-shot operation of the TC.

Writing a '0' to this bit has no effect

Writing a '1' to this bit will disable one-shot operation.

Value	Description
0	The TC will wrap around and continue counting on an overflow/underflow condition.
1	The TC will wrap around and stop on the next underflow/overflow condition.

#### Bit 1 – LUPD: Lock Update

This bit controls the update operation of the TC buffered registers.

When CTRLB.LUPD is set, no any update of the registers with value of its buffered register is performed on hardware UPDATE condition. Locking the update ensures that all buffer registers are valid before an

hardware update is performed. After all the buffer registers are loaded correctly, the buffered registers can be unlocked.

This bit has no effect when input capture operation is enabled.

Writing a '0' to this bit has no effect.

Writing a '1' to this bit will clear the LUPD bit.

Value	Description
0	The CCBUFx and PERBUF buffer registers value are copied into CCx and PER registers on hardware update condition.
1	The CCBUFx and PERBUF buffer registers value are not copied into CCx and PER registers on hardware update condition.

### Bit 0 – DIR: Counter Direction

This bit is used to change the direction of the counter.

Writing a '0' to this bit has no effect.

Writing a '1' to this bit will clear the bit and make the counter count up.

Value	Description
0	The timer/counter is counting up (incrementing).
1	The timer/counter is counting down (decrementing).

### 35.7.3.3 Control B Set

This register allows the user to set bits in the CTRLB register without doing a read-modify-write operation. Changes in this register will also be reflected in the Control B Clear register (CTRLBCLR).

**Name:** CTRLBSET

**Offset:** 0x05 [ID-00001cd8]

**Reset:** 0x00

**Property:** PAC Write-Protection, Read-synchronized, Write-Synchronized

Bit	7	6	5	4	3	2	1	0
	CMD[2:0]					ONESHOT	LUPD	DIR
Access	R/W	R/W	R/W			R/W	R/W	R/W
Reset	0	0	0			0	0	0

### Bits 7:5 – CMD[2:0]: Command

These bits are used for software control of the TC. The commands are executed on the next prescaled GCLK\_TC clock cycle. When a command has been executed, the CMD bit group will be read back as zero.

Writing 0x0 to these bits has no effect.

Writing a value different from 0x0 to these bits will issue a command for execution.

Value	Name	Description
0x0	NONE	No action
0x1	RETRIGGER	Force a start, restart or retrigger
0x2	STOP	Force a stop

Value	Name	Description
0x3	UPDATE	Force update of double buffered registers
0x4	READSYNC	Force a read synchronization of COUNT

### Bit 2 – ONESHOT: One-Shot on Counter

This bit controls one-shot operation of the TC.

Writing a '0' to this bit has no effect.

Writing a '1' to this bit will enable one-shot operation.

Value	Description
0	The TC will wrap around and continue counting on an overflow/underflow condition.
1	The TC will wrap around and stop on the next underflow/overflow condition.

### Bit 1 – LUPD: Lock Update

This bit controls the update operation of the TC buffered registers.

When CTRLB.LUPD is set, no any update of the registers with value of its buffered register is performed on hardware UPDATE condition. Locking the update ensures that all buffer registers are valid before an hardware update is performed. After all the buffer registers are loaded correctly, the buffered registers can be unlocked.

Writing a '0' to this bit has no effect.

Writing a '1' to this bit will set the LUPD bit.

This bit has no effect when input capture operation is enabled.

Value	Description
0	The CCBUF <sub>x</sub> and PERBUF buffer registers value are copied into CC <sub>x</sub> and PER registers on hardware update condition.
1	The CCBUF <sub>x</sub> and PERBUF buffer registers value are not copied into CC <sub>x</sub> and PER registers on hardware update condition.

### Bit 0 – DIR: Counter Direction

This bit is used to change the direction of the counter.

Writing a '0' to this bit has no effect

Writing a '1' to this bit will clear the bit and make the counter count up.

Value	Description
0	The timer/counter is counting up (incrementing).
1	The timer/counter is counting down (decrementing).

#### 35.7.3.4 Event Control

**Name:** EVCTRL

**Offset:** 0x06 [ID-00001cd8]

**Reset:** 0x0000

**Property:** PAC Write-Protection, Enable-Protected

	Bit	15	14	13	12	11	10	9	8
				MCEOx	MCEOx				OVFEO
Access				R/W	R/W				R/W
Reset				0	0				0
	Bit	7	6	5	4	3	2	1	0
				TCEI	TCINV		EVACT[2:0]		
Access				R/W	R/W		R/W	R/W	R/W
Reset				0	0		0	0	0

**Bits 13,12 – MCEOx: Match or Capture Channel x Event Output Enable [x = 1..0]**

These bits enable the generation of an event for every match or capture on channel x.

Value	Description
0	Match/Capture event on channel x is disabled and will not be generated.
1	Match/Capture event on channel x is enabled and will be generated for every compare/capture.

**Bit 8 – OVFEO: Overflow/Underflow Event Output Enable**

This bit enables the Overflow/Underflow event. When enabled, an event will be generated when the counter overflows/underflows.

Value	Description
0	Overflow/Underflow event is disabled and will not be generated.
1	Overflow/Underflow event is enabled and will be generated for every counter overflow/underflow.

**Bit 5 – TCEI: TC Event Enable**

This bit is used to enable asynchronous input events to the TC.

Value	Description
0	Incoming events are disabled.
1	Incoming events are enabled.

**Bit 4 – TCINV: TC Inverted Event Input Polarity**

This bit inverts the asynchronous input event source.

Value	Description
0	Input event source is not inverted.
1	Input event source is inverted.

**Bits 2:0 – EVACT[2:0]: Event Action**

These bits define the event action the TC will perform on an event.

Value	Name	Description
0x0	OFF	Event action disabled
0x1	RETRIGGER	Start, restart or retrigger TC on event
0x2	COUNT	Count on event
0x3	START	Start TC on event
0x4	STAMP	Time stamp capture
0x5	PPW	Period captured in CC0, pulse width in CC1

Value	Name	Description
0x6	PWP	Period captured in CC1, pulse width in CC0
0x7	PW	Pulse width capture

### 35.7.3.5 Interrupt Enable Clear

This register allows the user to disable an interrupt without doing a read-modify-write operation. Changes in this register will also be reflected in the Interrupt Enable Set register (INTENSET).

**Name:** INTENCLR

**Offset:** 0x08 [ID-00001cd8]

**Reset:** 0x00

**Property:** PAC Write-Protection

Bit	7	6	5	4	3	2	1	0
				MCx			ERR	OVF
Access				R/W			R/W	R/W
Reset				0			0	0

#### Bit 4 – MCx: Match or Capture Channel x Interrupt Enable

Writing a '0' to these bits has no effect.

Writing a '1' to MCx will clear the corresponding Match or Capture Channel x Interrupt Enable bit, which disables the Match or Capture Channel x interrupt.

Value	Description
0	The Match or Capture Channel x interrupt is disabled.
1	The Match or Capture Channel x interrupt is enabled.

#### Bit 1 – ERR: Error Interrupt Disable

Writing a '0' to this bit has no effect.

Writing a '1' to this bit will clear the Error Interrupt Enable bit, which disables the Error interrupt.

Value	Description
0	The Error interrupt is disabled.
1	The Error interrupt is enabled.

#### Bit 0 – OVF: Overflow Interrupt Disable

Writing a '0' to this bit has no effect.

Writing a '1' to this bit will clear the Overflow Interrupt Enable bit, which disables the Overflow interrupt request.

Value	Description
0	The Overflow interrupt is disabled.
1	The Overflow interrupt is enabled.

### 35.7.3.6 Interrupt Enable Set

This register allows the user to enable an interrupt without doing a read-modify-write operation. Changes in this register will also be reflected in the Interrupt Enable Clear register (INTENCLR).

**Name:** INTENSET  
**Offset:** 0x09 [ID-00001cd8]  
**Reset:** 0x00  
**Property:** PAC Write-Protection

	7	6	5	4	3	2	1	0
				MCx			ERR	OVF
Access				R/W			R/W	R/W
Reset				0			0	0

### Bit 4 – MCx: Match or Capture Channel x Interrupt Enable

Writing a '0' to these bits has no effect.

Writing a '1' to MCx will set the corresponding Match or Capture Channel x Interrupt Enable bit, which enables the Match or Capture Channel x interrupt.

Value	Description
0	The Match or Capture Channel x interrupt is disabled.
1	The Match or Capture Channel x interrupt is enabled.

### Bit 1 – ERR: Error Interrupt Enable

Writing a '0' to this bit has no effect.

Writing a '1' to this bit will set the Error Interrupt Enable bit, which enables the Error interrupt.

Value	Description
0	The Error interrupt is disabled.
1	The Error interrupt is enabled.

### Bit 0 – OVF: Overflow Interrupt Enable

Writing a '0' to this bit has no effect.

Writing a '1' to this bit will set the Overflow Interrupt Enable bit, which enables the Overflow interrupt request.

Value	Description
0	The Overflow interrupt is disabled.
1	The Overflow interrupt is enabled.

#### 35.7.3.7 Interrupt Flag Status and Clear

**Name:** INTFLAG  
**Offset:** 0x0A [ID-00001cd8]  
**Reset:** 0x00  
**Property:** -

Bit	7	6	5	4	3	2	1	0
				MCx			ERR	OVF
Access				R/W			R/W	R/W
Reset				0			0	0

**Bit 4 – MCx: Match or Capture Channel x**

This flag is set on a comparison match, or when the corresponding CCx register contains a valid capture value. This flag is set on the next CLK\_TC\_CNT cycle, and will generate an interrupt request if the corresponding Match or Capture Channel x Interrupt Enable bit in the Interrupt Enable Set register (INTENSET.MCx) is '1'.

Writing a '0' to one of these bits has no effect.

Writing a '1' to one of these bits will clear the corresponding Match or Capture Channel x interrupt flag

In capture operation, this flag is automatically cleared when CCx register is read.

**Bit 1 – ERR: Error Interrupt Flag**

This flag is set when a new capture occurs on a channel while the corresponding Match or Capture Channel x interrupt flag is set, in which case there is nowhere to store the new capture.

Writing a '0' to this bit has no effect.

Writing a '1' to this bit clears the Error interrupt flag.

**Bit 0 – OVF: Overflow Interrupt Flag**

This flag is set on the next CLK\_TC\_CNT cycle after an overflow condition occurs, and will generate an interrupt request if INTENCLR.OVF or INTENSET.OVF is '1'.

Writing a '0' to this bit has no effect.

Writing a '1' to this bit clears the Overflow interrupt flag.

**35.7.3.8 Status**

**Name:** STATUS  
**Offset:** 0x0B [ID-00001cd8]  
**Reset:** 0x01  
**Property:** Read-Synchronized

Bit	7	6	5	4	3	2	1	0
				CCBUFVx	PERBUFV		SLAVE	STOP
Access				R/W	R/W		R	R
Reset				0	0		0	1

**Bit 4 – CCBUFVx: Channel x Compare or Capture Buffer Valid**

For a compare channel x, the bit x is set when a new value is written to the corresponding CCBUFx register.

The bit x is cleared by writing a '1' to it when CTRLB.LUPD is set, or it is cleared automatically by hardware on UPDATE condition.

For a capture channel x, the bit x is set when a valid capture value is stored in the CCBUFx register. The bit x is cleared automatically when the CCx register is read.

### Bit 3 – PERBUFV: Period Buffer Valid

This bit is set when a new value is written to the PERBUF register. The bit is cleared by writing '1' to the corresponding location when CTRLB.LUPD is set, or automatically cleared by hardware on UPDATE condition. This bit is available only in 8-bit mode and will always read zero in 16- and 32-bit modes.

### Bit 1 – SLAVE: Slave Status Flag

This bit is only available in 32-bit mode on the slave TC (i.e., TC1 and/or TC3). The bit is set when the associated master TC (TC0 and TC2, respectively) is set to run in 32-bit mode.

### Bit 0 – STOP: Stop Status Flag

This bit is set when the TC is disabled, on a Stop command, or on an overflow/underflow condition when the One-Shot bit in the Control B Set register (CTRLBSET.ONESHOT) is '1'.

Value	Description
0	Counter is running.
1	Counter is stopped.

### 35.7.3.9 Waveform Generation Control

**Name:** WAVE

**Offset:** 0x0C [ID-00001cd8]

**Reset:** 0x00

**Property:** PAC Write-Protection, Enable-Protected

Bit	7	6	5	4	3	2	1	0
							WAVEGEN[1:0]	
Access							R/W	R/W
Reset							0	0

### Bits 1:0 – WAVEGEN[1:0]: Waveform Generation Mode

These bits select the waveform generation operation. They affect the top value, as shown in [Waveform Output Operations](#). They also control whether frequency or PWM waveform generation should be used. The waveform generation operations are explained in [Waveform Output Operations](#).

These bits are not synchronized.

Value	Name	Operation	Top Value	Output Waveform on Match	Output Waveform on Wraparound
0x0	NFRQ	Normal frequency	PER <sup>1</sup> / Max	Toggle	No action
0x1	MFRQ	Match frequency	CC0	Toggle	No action
0x2	NPWM	Normal PWM	PER <sup>1</sup> / Max	Set	Clear
0x3	MPWM	Match PWM	CC0	Set	Clear

1) This depends on the TC mode: In 8-bit mode, the top value is the Period Value register (PER). In 16- and 32-bit mode it is the respective MAX value.

### 35.7.3.10 Driver Control



**Name:** DRVCTRL  
**Offset:** 0x0D [ID-00001cd8]  
**Reset:** 0x00  
**Property:** PAC Write-Protection, Enable-Protected

	7	6	5	4	3	2	1	0
								INVENx
Access								R/W
Reset								0

**Bit 0 – INVENx: Output Waveform x Invert Enable**

Bit x of INVEN[1:0] selects inversion of the output or capture trigger input of channel x.

Value	Description
0	Disable inversion of the WO[x] output and IO input pin.
1	Enable inversion of the WO[x] output and IO input pin.

### 35.7.3.11 Debug Control

**Name:** DBGCTRL  
**Offset:** 0x0F [ID-00001cd8]  
**Reset:** 0x00  
**Property:** PAC Write-Protection

	7	6	5	4	3	2	1	0
								DBGRUN
Access								R/W
Reset								0

**Bit 0 – DBGRUN: Run in Debug Mode**

This bit is not affected by a software Reset, and should not be changed by software while the TC is enabled.

Value	Description
0	The TC is halted when the device is halted in debug mode.
1	The TC continues normal operation when the device is halted in debug mode.

### 35.7.3.12 Synchronization Busy

**Name:** SYNCBUSY  
**Offset:** 0x10 [ID-00001cd8]  
**Reset:** 0x00000000  
**Property:** -

Bit	31	30	29	28	27	26	25	24
Access								
Reset								
Bit	23	22	21	20	19	18	17	16
Access								
Reset								
Bit	15	14	13	12	11	10	9	8
Access								
Reset								
Bit	7	6	5	4	3	2	1	0
		CCx	PER	COUNT	STATUS	CTRLB	ENABLE	SWRST
Access		R	R	R	R	R	R	R
Reset		0	0	0	0	0	0	0

**Bit 6 – CCx: Compare/Capture Channel x Synchronization Busy**

For details on CC channels number, refer to each TC feature list.

This bit is set when the synchronization of CCx between clock domains is started.

This bit is also set when the CCBUFx is written, and cleared on update condition. The bit is automatically cleared when the STATUS.CCBUFx bit is cleared.

**Bit 5 – PER: PER Synchronization Busy**

This bit is cleared when the synchronization of PER between the clock domains is complete.

This bit is set when the synchronization of PER between clock domains is started.

This bit is also set when the PER is written, and cleared on update condition. The bit is automatically cleared when the STATUS.PERBUF bit is cleared.

**Bit 4 – COUNT: COUNT Synchronization Busy**

This bit is cleared when the synchronization of COUNT between the clock domains is complete.

This bit is set when the synchronization of COUNT between clock domains is started.

**Bit 3 – STATUS: STATUS Synchronization Busy**

This bit is cleared when the synchronization of STATUS between the clock domains is complete.

This bit is set when a '1' is written to the Capture Channel Buffer Valid status flags (STATUS.CCBUFVx) and the synchronization of STATUS between clock domains is started.

**Bit 2 – CTRLB: CTRLB Synchronization Busy**

This bit is cleared when the synchronization of CTRLB between the clock domains is complete.

This bit is set when the synchronization of CTRLB between clock domains is started.

**Bit 1 – ENABLE: ENABLE Synchronization Busy**

This bit is cleared when the synchronization of ENABLE bit between the clock domains is complete.

This bit is set when the synchronization of ENABLE bit between clock domains is started.

**Bit 0 – SWRST: SWRST Synchronization Busy**

This bit is cleared when the synchronization of SWRST bit between the clock domains is complete.

This bit is set when the synchronization of SWRST bit between clock domains is started.

**35.7.3.13 Counter Value, 32-bit Mode**

**Note:** Prior to any read access, this register must be synchronized by user by writing the according TC Command value to the Control B Set register (CTRLBSET.CMD=READSYNC).

**Name:** COUNT

**Offset:** 0x14 [ID-00001cd8]

**Reset:** 0x00

**Property:** PAC Write-Protection, Write-Synchronized, Read-Synchronized

Bit	31	30	29	28	27	26	25	24
	COUNT[31:24]							
Access	R/W	R/W	R/W	R/W	R/W	R/W	R/W	R/W
Reset	0	0	0	0	0	0	0	0
Bit	23	22	21	20	19	18	17	16
	COUNT[23:16]							
Access	R/W	R/W	R/W	R/W	R/W	R/W	R/W	R/W
Reset	0	0	0	0	0	0	0	0
Bit	15	14	13	12	11	10	9	8
	COUNT[15:8]							
Access	R/W	R/W	R/W	R/W	R/W	R/W	R/W	R/W
Reset	0	0	0	0	0	0	0	0
Bit	7	6	5	4	3	2	1	0
	COUNT[7:0]							
Access	R/W	R/W	R/W	R/W	R/W	R/W	R/W	R/W
Reset	0	0	0	0	0	0	0	0

**Bits 31:0 – COUNT[31:0]: Counter Value**

These bits contain the current counter value.

**35.7.3.14 Period Value, 32-bit Mode**

**Name:** PER

**Offset:** 0x1A [ID-00001cd8]

**Reset:** 0xFFFFFFFF

**Property:** Write-Synchronized

Bit	31	30	29	28	27	26	25	24
PER[31:24]								
Access	R/W	R/W	R/W	R/W	R/W	R/W	R/W	R/W
Reset	0	0	0	0	0	0	0	0
Bit	23	22	21	20	19	18	17	16
PER[23:16]								
Access	R/W	R/W	R/W	R/W	R/W	R/W	R/W	R/W
Reset	0	0	0	0	0	0	0	0
Bit	15	14	13	12	11	10	9	8
PER[15:8]								
Access	R/W	R/W	R/W	R/W	R/W	R/W	R/W	R/W
Reset	0	0	0	0	0	0	0	0
Bit	7	6	5	4	3	2	1	0
PER[7:0]								
Access	R/W	R/W	R/W	R/W	R/W	R/W	R/W	R/W
Reset	0	0	0	0	0	0	0	1

**Bits 31:0 – PER[31:0]: Period Value**

These bits hold the value of the Period Buffer register PERBUF. The value is copied to PER register on UPDATE condition.

**35.7.3.15 Channel x Compare/Capture Value, 32-bit Mode**

**Name:** CCx  
**Offset:** 0x1C + x\*0x04 [x=0..1]  
**Reset:** 0x00000000  
**Property:** Write-Synchronized

Bit	31	30	29	28	27	26	25	24
	CC[31:24]							
Access	R/W	R/W	R/W	R/W	R/W	R/W	R/W	R/W
Reset	0	0	0	0	0	0	0	0
Bit	23	22	21	20	19	18	17	16
	CC[23:16]							
Access	R/W	R/W	R/W	R/W	R/W	R/W	R/W	R/W
Reset	0	0	0	0	0	0	0	0
Bit	15	14	13	12	11	10	9	8
	CC[15:8]							
Access	R/W	R/W	R/W	R/W	R/W	R/W	R/W	R/W
Reset	0	0	0	0	0	0	0	0
Bit	7	6	5	4	3	2	1	0
	CC[7:0]							
Access	R/W	R/W	R/W	R/W	R/W	R/W	R/W	R/W
Reset	0	0	0	0	0	0	0	0

**Bits 31:0 – CC[31:0]: Channel x Compare/Capture Value**

These bits contain the compare/capture value in 32-bit TC mode. In Match frequency (MFRQ) or Match PWM (MPWM) waveform operation (WAVE.WAVEGEN), the CC0 register is used as a period register.

**35.7.3.16 Period Buffer Value, 32-bit Mode**

**Name:** PERBUF  
**Offset:** 0x2C [ID-00001cd8]  
**Reset:** 0xFFFFFFFF  
**Property:** Write-Synchronized

Bit	31	30	29	28	27	26	25	24
	PERBUF[31:24]							
Access	R/W	R/W	R/W	R/W	R/W	R/W	R/W	R/W
Reset	0	0	0	0	0	0	0	0
Bit	23	22	21	20	19	18	17	16
	PERBUF[23:16]							
Access	R/W	R/W	R/W	R/W	R/W	R/W	R/W	R/W
Reset	0	0	0	0	0	0	0	0
Bit	15	14	13	12	11	10	9	8
	PERBUF[15:8]							
Access	R/W	R/W	R/W	R/W	R/W	R/W	R/W	R/W
Reset	0	0	0	0	0	0	0	0
Bit	7	6	5	4	3	2	1	0
	PERBUF[7:0]							
Access	R/W	R/W	R/W	R/W	R/W	R/W	R/W	R/W
Reset	0	0	0	0	0	0	0	1

**Bits 31:0 – PERBUF[31:0]: Period Buffer Value**

These bits hold the value of the period buffer register. The value is copied to PER register on UPDATE condition.

**35.7.3.17 Channel x Compare Buffer Value, 32-bit Mode**

**Name:** CCBUFx  
**Offset:** 0x30 + x\*0x04 [x=0..1]  
**Reset:** 0x00000000  
**Property:** Write-Synchronized

Bit	31	30	29	28	27	26	25	24
	CCBUF[31:24]							
Access	R/W	R/W	R/W	R/W	R/W	R/W	R/W	R/W
Reset	0	0	0	0	0	0	0	0
Bit	23	22	21	20	19	18	17	16
	CCBUF[23:16]							
Access	R/W	R/W	R/W	R/W	R/W	R/W	R/W	R/W
Reset	0	0	0	0	0	0	0	0
Bit	15	14	13	12	11	10	9	8
	CCBUF[15:8]							
Access	R/W	R/W	R/W	R/W	R/W	R/W	R/W	R/W
Reset	0	0	0	0	0	0	0	0
Bit	7	6	5	4	3	2	1	0
	CCBUF[7:0]							
Access	R/W	R/W	R/W	R/W	R/W	R/W	R/W	R/W
Reset	0	0	0	0	0	0	0	0

**Bits 31:0 – CCBUF[31:0]: Channel x Compare Buffer Value**

These bits hold the value of the Channel x Compare Buffer Value. When the buffer valid flag is '1' and double buffering is enabled (CTRLBCLR.LUPD=1), the data from buffer registers will be copied into the corresponding CCx register under UPDATE condition (CTRLBSET.CMD=0x3), including the software update command.

## **36. TCC – Timer/Counter for Control Applications**

### **36.1 Overview**

The device provides three instances of the Timer/Counter for Control applications (TCC) peripheral, TCC[2:0].

Each TCC instance consists of a counter, a prescaler, compare/capture channels and control logic. The counter can be set to count events or clock pulses. The counter together with the compare/capture channels can be configured to time stamp input events, allowing capture of frequency and pulse-width. It can also perform waveform generation such as frequency generation and pulse-width modulation.

Waveform extensions are intended for motor control, ballast, LED, H-bridge, power converters, and other types of power control applications. They allow for low- and high-side output with optional dead-time insertion. Waveform extensions can also generate a synchronized bit pattern across the waveform output pins. The fault options enable fault protection for safe and deterministic handling, disabling and/or shut down of external drivers.

[Figure 36-1](#) shows all features in TCC.

#### **Related Links**

[TCC Configurations](#)

### **36.2 Features**

- Up to four compare/capture channels (CC) with:
  - Double buffered period setting
  - Double buffered compare or capture channel
  - Circular buffer on period and compare channel registers
- Waveform generation:
  - Frequency generation
  - Single-slope pulse-width modulation (PWM)
  - Dual-slope pulse-width modulation with half-cycle reload capability
- Input capture:
  - Event capture
  - Frequency capture
  - Pulse-width capture
- Waveform extensions:
  - Configurable distribution of compare channels outputs across port pins
  - Low- and high-side output with programmable dead-time insertion
  - Waveform swap option with double buffer support
  - Pattern generation with double buffer support
  - Dithering support
- Fault protection for safe disabling of drivers:
  - Two recoverable fault sources
  - Two non-recoverable fault sources
  - Debugger can be source of non-recoverable fault



- Input events:
  - Two input events for counter
  - One input event for each channel
- Output events:
  - Three output events (Count, Re-Trigger and Overflow) available for counter
  - One Compare Match/Input Capture event output for each channel
- Interrupts:
  - Overflow and Re-Trigger interrupt
  - Compare Match/Input Capture interrupt
  - Interrupt on fault detection
- Can be used with DMA and can trigger DMA transactions

## 36.3 Block Diagram

Figure 36-1. Timer/Counter for Control Applications - Block Diagram



## 36.4 Signal Description

Pin Name	Type	Description
TCCx/WO[0]	Digital output	Compare channel 0 waveform output
TCCx/WO[1]	Digital output	Compare channel 1 waveform output

Pin Name	Type	Description
...	...	...
TCCx/WO[WO_NUM-1]	Digital output	Compare channel n waveform output

Refer to *I/O Multiplexing and Considerations* for details on the pin mapping for this peripheral. One signal can be mapped on several pins.

**Related Links**

[I/O Multiplexing and Considerations](#)

## 36.5 Product Dependencies

In order to use this peripheral, other parts of the system must be configured correctly, as described below.

### 36.5.1 I/O Lines

In order to use the I/O lines of this peripheral, the I/O pins must be configured using the I/O Pin Controller (PORT).

**Related Links**

[PORT: IO Pin Controller](#)

### 36.5.2 Power Management

This peripheral can continue to operate in any sleep mode where its source clock is running. The interrupts can wake up the device from sleep modes. Events connected to the event system can trigger other operations in the system without exiting sleep modes.

### 36.5.3 Clocks

The TCC bus clock (CLK\_TCCx\_APB, with x instance number of the TCCx) is enabled by default, and can be enabled and disabled in the Main Clock.

A generic clock (GCLK\_TCCx) is required to clock the TCC. This clock must be configured and enabled in the generic clock controller before using the TCC. Note that TCC0 and TCC1 share a peripheral clock generator.

The generic clocks (GCLK\_TCCx) are asynchronous to the bus clock (CLK\_TCCx\_APB). Due to this asynchronicity, writing certain registers will require synchronization between the clock domains. Refer to [Synchronization](#) for further details.

**Related Links**

[Peripheral Clock Masking](#)

[GCLK - Generic Clock Controller](#)

### 36.5.4 DMA

The DMA request lines are connected to the DMA Controller (DMAC). In order to use DMA requests with this peripheral the DMAC must be configured first. Refer to *DMAC – Direct Memory Access Controller* for details.

**Related Links**

[DMAC – Direct Memory Access Controller](#)

## 36.5.5 Interrupts

The interrupt request line is connected to the Interrupt Controller. In order to use interrupt requests of this peripheral, the Interrupt Controller (NVIC) must be configured first. Refer to *Nested Vector Interrupt Controller* for details.

### Related Links

[Nested Vector Interrupt Controller](#)

## 36.5.6 Events

The events of this peripheral are connected to the Event System.

### Related Links

[EVSYS – Event System](#)

## 36.5.7 Debug Operation

When the CPU is halted in debug mode, this peripheral will halt normal operation. This peripheral can be forced to continue operation during debugging - refer to the Debug Control (DBGCTRL) register for details.

Refer to [DBGCTRL](#) register for details.

## 36.5.8 Register Access Protection

Registers with write-access can be optionally write-protected by the Peripheral Access Controller (PAC), except for the following:

- Interrupt Flag register (INTFLAG)
- Status register (STATUS)
- Period and Period Buffer registers (PER, PERBUF)
- Compare/Capture and Compare/Capture Buffer registers (CCx, CCBUFx)
- Control Waveform register (WAVE)
- Control Waveform Buffer register (WAVEBUF)
- Pattern Generation Value and Pattern Generation Value Buffer registers (PATT, PATTBUF)

**Note:** Optional write-protection is indicated by the "PAC Write-Protection" property in the register description.

When the CPU is halted in debug mode, all write-protection is automatically disabled. Write-protection does not apply for accesses through an external debugger.

## 36.5.9 Analog Connections

Not applicable.

## 36.6 Functional Description

### 36.6.1 Principle of Operation

The following definitions are used throughout the documentation:

**Table 36-1. Timer/Counter for Control Applications - Definitions**

Name	Description
TOP	The counter reaches TOP when it becomes equal to the highest value in the count sequence. The TOP value can be the same as Period (PER) or the Compare Channel 0 (CC0) register value depending on the waveform generator mode in <a href="#">Waveform Output Generation Operations</a> .
ZERO	The counter reaches ZERO when it contains all zeroes.
MAX	The counter reaches maximum when it contains all ones.
UPDATE	The timer/counter signals an update when it reaches ZERO or TOP, depending on the direction settings.
Timer	The timer/counter clock control is handled by an internal source.
Counter	The clock control is handled externally (e.g. counting external events).
CC	For compare operations, the CC are referred to as "compare channels." For capture operations, the CC are referred to as "capture channels."

Each TCC instance has up to four compare/capture channels (CCx).

The counter register (COUNT), period registers with buffer (PER and PERBUF), and compare and capture registers with buffers (CCx and CCBUFx) are 16- or 24-bit registers, depending on each TCC instance. Each buffer register has a buffer valid (BUFV) flag that indicates when the buffer contains a new value.

Under normal operation, the counter value is continuously compared to the TOP or ZERO value to determine whether the counter has reached TOP or ZERO. In either case, the TCC can generate interrupt requests, request DMA transactions, or generate events for the Event System. In waveform generator mode, these comparisons are used to set the waveform period or pulse width.

A prescaled generic clock (GCLK\_TCCx) and events from the event system can be used to control the counter. The event system is also used as a source to the input capture.

The Recoverable Fault Unit enables event controlled waveforms by acting directly on the generated waveforms of the TCC compare channels output. These events can restart, halt the timer/counter period, shorten the output pulse active time, or disable waveform output as long as the fault condition is present. This can typically be used for current sensing regulation, and zero-crossing and demagnetization re-triggering.

The MCE0 and MCE1 event sources are shared with the Recoverable Fault Unit. Only asynchronous events are used internally when fault unit extension is enabled. For further details on how to configure asynchronous events routing, refer to *EVSYS – Event System*.

Recoverable fault sources can be filtered and/or windowed to avoid false triggering, for example from I/O pin glitches, by using digital filtering, input blanking, and qualification options. See also [Recoverable Faults](#).

In addition, six optional independent and successive units primarily intended for use with different types of motor control, ballast, LED, H-bridge, power converter, and other types of power switching applications, are implemented in some of TCC instances. See also [Figure 36-1](#).

The output matrix (OTMX) can distribute and route out the TCC waveform outputs across the port pins in different configurations, each optimized for different application types. The Dead-Time Insertion (DTI) unit

splits the four lower OTMX outputs into two non-overlapping signals: the non-inverted low side (LS) and inverted high side (HS) of the waveform output with optional dead-time insertion between LS and HS switching. The SWAP unit can swap the LS and HS pin outputs, and can be used for fast decay motor control.

The pattern generation unit can be used to generate synchronized waveforms with constant logic level on TCC UPDATE conditions. This is useful for easy stepper motor and full bridge control.

The non-recoverable fault module enables event controlled fault protection by acting directly on the generated waveforms of the timer/counter compare channel outputs. When a non-recoverable fault condition is detected, the output waveforms are forced to a safe and pre-configured value that is safe for the application. This is typically used for instant and predictable shut down and disabling high current or voltage drives.

The count event sources (TCE0 and TCE1) are shared with the non-recoverable fault extension. The events can be optionally filtered. If the filter options are not used, the non-recoverable faults provide an immediate asynchronous action on waveform output, even for cases where the clock is not present. For further details on how to configure asynchronous events routing, refer to section *EVSYS – Event System*.

## Related Links

[EVSYS – Event System](#)

## 36.6.2 Basic Operation

### 36.6.2.1 Initialization

The following registers are enable-protected, meaning that they can only be written when the TCC is disabled (CTRLA.ENABLE=0):

- Control A (CTRLA) register, except Run Standby (RUNSTDBY), Enable (ENABLE) and Software Reset (SWRST) bits
- Recoverable Fault n Control registers (FCTRLA and FCTRLB)
- Waveform Extension Control register (WEXCTRL)
- Drive Control register (DRVCTRL)
- Event Control register (EVCTRL)

Enable-protected bits in the CTRLA register can be written at the same time as CTRLA.ENABLE is written to '1', but not at the same time as CTRLA.ENABLE is written to '0'. Enable-protection is denoted by the “Enable-Protected” property in the register description.

Before the TCC is enabled, it must be configured as outlined by the following steps:

1. Enable the TCC bus clock (CLK\_TCCx\_APB).
2. If Capture mode is required, enable the channel in capture mode by writing a '1' to the Capture Enable bit in the Control A register (CTRLA.CPTEN).

Optionally, the following configurations can be set before enabling TCC:

1. Select PRESCALER setting in the Control A register (CTRLA.PRESCALER).
2. Select Prescaler Synchronization setting in Control A register (CTRLA.PRESCSYNC).
3. If down-counting operation is desired, write the Counter Direction bit in the Control B Set register (CTRLBSET.DIR) to '1'.
4. Select the Waveform Generation operation in the WAVE register (WAVE.WAVEGEN).
5. Select the Waveform Output Polarity in the WAVE register (WAVE.POL).
6. The waveform output can be inverted for the individual channels using the Waveform Output Invert Enable bit group in the Driver register (DRVCTRL.INVEN).

## 36.6.2.2 Enabling, Disabling, and Resetting

The TCC is enabled by writing a '1' to the Enable bit in the Control A register (CTRLA.ENABLE). The TCC is disabled by writing a zero to CTRLA.ENABLE.

The TCC is reset by writing '1' to the Software Reset bit in the Control A register (CTRLA.SWRST). All registers in the TCC, except DBGCTRL, will be reset to their initial state, and the TCC will be disabled. Refer to Control A (CTRLA) register for details.

The TCC should be disabled before the TCC is reset to avoid undefined behavior.

## 36.6.2.3 Prescaler Selection

The GCLK\_TCCx clock is fed into the internal prescaler.

The prescaler consists of a counter that counts up to the selected prescaler value, whereupon the output of the prescaler toggles.

If the prescaler value is higher than one, the counter update condition can be optionally executed on the next GCLK\_TCC clock pulse or the next prescaled clock pulse. For further details, refer to the Prescaler (CTRLA.PRESCALER) and Counter Synchronization (CTRLA.PRESYNC) descriptions.

Prescaler outputs from 1 to 1/1024 are available. For a complete list of available prescaler outputs, see the register description for the Prescaler bit group in the Control A register (CTRLA.PRESCALER).

**Note:** When counting events, the prescaler is bypassed.

The joint stream of prescaler ticks and event action ticks is called CLK\_TCC\_COUNT.

**Figure 36-2. Prescaler**



## 36.6.2.4 Counter Operation

Depending on the mode of operation, the counter is cleared, reloaded, incremented, or decremented at each TCC clock input (CLK\_TCC\_COUNT). A counter clear or reload marks the end of current counter cycle and the start of a new one.

The counting direction is set by the Direction bit in the Control B register (CTRLB.DIR). If the bit is zero, it's counting up and one if counting down.

The counter will count up or down for each tick (clock or event) until it reaches TOP or ZERO. When it's counting up and TOP is reached, the counter will be set to zero at the next tick (overflow) and the Overflow Interrupt Flag in the Interrupt Flag Status and Clear register (INTFLAG.OVF) will be set. When down-counting, the counter is reloaded with the TOP value when ZERO is reached (underflow), and INTFLAG.OVF is set.

INTFLAG.OVF can be used to trigger an interrupt, a DMA request, or an event. An overflow/underflow occurrence (i.e. a compare match with TOP/ZERO) will stop counting if the One-Shot bit in the Control B register is set (CTRLBSET.ONESHOT).

Figure 36-3. Counter Operation

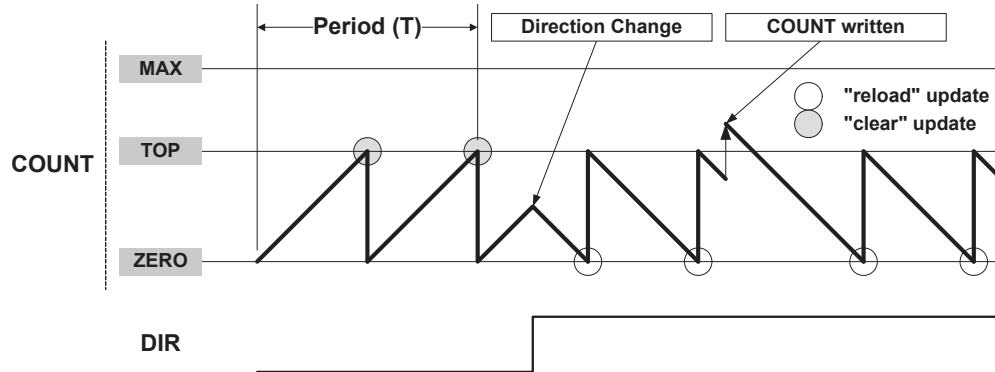

It is possible to change the counter value (by writing directly in the COUNT register) even when the counter is running. The COUNT value will always be ZERO or TOP, depending on direction set by CTRLBSET.DIR or CTRLBCLR.DIR, when starting the TCC, unless a different value has been written to it, or the TCC has been stopped at a value other than ZERO. The write access has higher priority than count, clear, or reload. The direction of the counter can also be changed during normal operation. See also [Figure 36-3](#).

### Stop Command

A stop command can be issued from software by using TCC Command bits in Control B Set register (CTRLBSET.CMD=0x2, STOP).

### Pause Event Action

A pause command can be issued when the stop event action is configured in the Input Event Action 1 bits in Event Control register (EVCTRL.EVACT1=0x3, STOP).

### Re-Trigger Command and Event Action

A re-trigger command can be issued from software by using TCC Command bits in Control B Set register (CTRLBSET.CMD=0x1, RETRIGGER), or from event when the re-trigger event action is configured in the Input Event 0/1 Action bits in Event Control register (EVCTRL.EVACTn=0x1, RETRIGGER).

When the command is detected during counting operation, the counter will be reloaded or cleared, depending on the counting direction (CTRLBSET.DIR or CTRLBCLR.DIR). The Re-Trigger bit in the Interrupt Flag Status and Clear register will be set (INTFLAG.TRG). It is also possible to generate an event by writing a '1' to the Re-Trigger Event Output Enable bit in the Event Control register (EVCTRL.TRGEO). If the re-trigger command is detected when the counter is stopped, the counter will resume counting operation from the value in COUNT.

### Note:

When a re-trigger event action is configured in the Event Action bits in the Event Control register (EVCTRL.EVACTn=0x1, RETRIGGER), enabling the counter will not start the counter. The counter will start on the next incoming event and restart on corresponding following event.

### Start Event Action

The start action can be selected in the Event Control register (EVCTRL.EVACT0=0x3, START) and can start the counting operation when previously stopped. The event has no effect if the counter is already counting. When the module is enabled, the counter operation starts when the event is received or when a re-trigger software command is applied.

### Note:

When a start event action is configured in the Event Action bits in the Event Control register (EVCTRL.EVACT0=0x3, START), enabling the counter will not start the counter. The counter will start on the next incoming event, but it will not restart on subsequent events.

## Count Event Action

The TCC can count events. When an event is received, the counter increases or decreases the value, depending on direction settings (CTRLBSET.DIR or CTRLBCLR.DIR).

The count event action is selected by the Event Action 0 bit group in the Event Control register (EVCTRL.EVACT0=0x5, COUNT).

## Direction Event Action

The direction event action can be selected in the Event Control register (EVCTRL.EVACT1=0x2, DIR). When this event is used, the asynchronous event path specified in the event system must be configured or selected. The direction event action can be used to control the direction of the counter operation, depending on external events level. When received, the event level overrides the Direction settings (CTRLBSET.DIR or CTRLBCLR.DIR) and the direction bit value is updated accordingly.

## Increment Event Action

The increment event action can be selected in the Event Control register (EVCTRL.EVACT0=0x4, INC) and can change the counter state when an event is received. When the TCE0 event (TCCx\_EV0) is received, the counter increments, whatever the direction setting (CTRLBSET.DIR or CTRLBCLR.DIR) is.

## Decrement Event Action

The decrement event action can be selected in the Event Control register (EVCTRL.EVACT1=0x4, DEC) and can change the counter state when an event is received. When the TCE1 (TCCx\_EV1) event is received, the counter decrements, whatever the direction setting (CTRLBSET.DIR or CTRLBCLR.DIR) is.

## Non-recoverable Fault Event Action

Non-recoverable fault actions can be selected in the Event Control register (EVCTRL.EVACTn=0x7, FAULT). When received, the counter will be stopped and the output of the compare channels is overridden according to the Driver Control register settings (DRVCTRL.NREx and DRVCTRL.NRVx). TCE0 and TCE1 must be configured as asynchronous events.

## Event Action Off

If the event action is disabled (EVCTRL.EVACTn=0x0, OFF), enabling the counter will also start the counter.

### 36.6.2.5 Compare Operations

By default, the Compare/Capture channel is configured for compare operations. To perform capture operations, it must be re-configured.

When using the TCC with the Compare/Capture Value registers (CCx) for compare operations, the counter value is continuously compared to the values in the CCx registers. This can be used for timer or for waveform operation.

The Channel x Compare/Capture Buffer Value (CCBUFx) registers provide double buffer capability. The double buffering synchronizes the update of the CCx register with the buffer value at the UPDATE condition or a force update command (CTRLBSET.CMD=0x3, UPDATE). For further details, refer to [Double Buffering](#). The synchronization prevents the occurrence of odd-length, non-symmetrical pulses and ensures glitch-free output.



## Waveform Output Generation Operations

The compare channels can be used for waveform generation on output port pins. To make the waveform available on the connected pin, the following requirements must be fulfilled:

1. Choose a waveform generation mode in the Waveform Generation Operation bit in Waveform register (WAVE.WAVEGEN).
2. Optionally invert the waveform output WO[x] by writing the corresponding Waveform Output x Inversion bit in the Driver Control register (DRVCTRL.INVENx).
3. Configure the pins with the I/O Pin Controller. Refer to *PORT - I/O Pin Controller* for details.

The counter value is continuously compared with each CCx value. On a comparison match, the Match or Capture Channel x bit in the Interrupt Flag Status and Clear register (INTFLAG.MCx) will be set on the next zero-to-one transition of CLK\_TCC\_COUNT (see Normal Frequency Operation). An interrupt and/or event can be generated on the same condition if Match/Capture occurs, i.e. INTENSET.MCx and/or EVCTRL.MCEx is '1'. Both interrupt and event can be generated simultaneously. The same condition generates a DMA request.

There are seven waveform configurations for the Waveform Generation Operation bit group in the Waveform register (WAVE.WAVEGEN). This will influence how the waveform is generated and impose restrictions on the top value. The configurations are:

- Normal Frequency (NFRQ)
- Match Frequency (MFRQ)
- Normal Pulse-Width Modulation (NPWM)
- Dual-slope, interrupt/event at TOP (DSTOP)
- Dual-slope, interrupt/event at ZERO (DSBOTTOM)
- Dual-slope, interrupt/event at Top and ZERO (DSBOTH)
- Dual-slope, critical interrupt/event at ZERO (DSCRITICAL)

When using MFRQ configuration, the TOP value is defined by the CC0 register value. For the other waveform operations, the TOP value is defined by the Period (PER) register value.

For dual-slope waveform operations, the update time occurs when the counter reaches ZERO. For the other waveforms generation modes, the update time occurs on counter wraparound, on overflow, underflow, or re-trigger.

The table below shows the update counter and overflow event/interrupt generation conditions in different operation modes.

**Table 36-2. Counter Update and Overflow Event/interrupt Conditions**

Name	Operation	TOP	Update	Output Waveform		OVFIF/Event	
				On Match	On Update	Up	Down
NFRQ	Normal Frequency	PER	TOP/ ZERO	Toggle	Stable	TOP	ZERO
MFRQ	Match Frequency	CC0	TOP/ ZERO	Toggle	Stable	TOP	ZERO
NPWM	Single-slope PWM	PER	TOP/ ZERO	See section 'Output Polarity' below		TOP	ZERO
DSCRITICAL	Dual-slope PWM	PER	ZERO			-	ZERO

Name	Operation	TOP	Update	Output Waveform		OVFIF/Event	
				On Match	On Update	Up	Down
DSBOTTOM	Dual-slope PWM	PER	ZERO			-	ZERO
DSBOTH	Dual-slope PWM	PER	TOP <sup>(1)</sup> & ZERO			TOP	ZERO
DSTOP	Dual-slope PWM	PER	ZERO			TOP	-

- The UPDATE condition on TOP only will occur when circular buffer is enabled for the channel.

### Related Links

[Circular Buffer](#)

[PORT: IO Pin Controller](#)

### Normal Frequency (NFRQ)

For Normal Frequency generation, the period time (T) is controlled by the period register (PER). The waveform generation output (WO[x]) is toggled on each compare match between COUNT and CCx, and the corresponding Match or Capture Channel x Interrupt Flag (EVCTRL.MCEOx) will be set.

**Figure 36-4. Normal Frequency Operation**



### Match Frequency (MFRQ)

For Match Frequency generation, the period time (T) is controlled by CC0 register instead of PER. WO[0] toggles on each update condition.

**Figure 36-5. Match Frequency Operation**



## Normal Pulse-Width Modulation (NPWM)

NPWM uses single-slope PWM generation.

### Single-Slope PWM Operation

For single-slope PWM generation, the period time (T) is controlled by Top value, and CCx controls the duty cycle of the generated waveform output. When up-counting, the WO[x] is set at start or compare match between the COUNT and TOP values, and cleared on compare match between COUNT and CCx register values. When down-counting, the WO[x] is cleared at start or compare match between the COUNT and ZERO values, and set on compare match between COUNT and CCx register values.

**Figure 36-6. Single-Slope PWM Operation**



The following equation calculates the exact resolution for a single-slope PWM ( $R_{PWM\_SS}$ ) waveform:

$$R_{PWM\_SS} = \frac{\log(TOP+1)}{\log(2)}$$

The PWM frequency depends on the Period register value (PER) and the peripheral clock frequency ( $f_{GCLK\_TCC}$ ), and can be calculated by the following equation:

$$f_{PWM\_SS} = \frac{f_{GCLK\_TCC}}{N(TOP+1)}$$

Where N represents the prescaler divider used (1, 2, 4, 8, 16, 64, 256, 1024).

### Dual-Slope PWM Generation

For dual-slope PWM generation, the period setting (TOP) is controlled by PER, while CCx control the duty cycle of the generated waveform output. The figure below shows how the counter repeatedly counts from ZERO to PER and then from PER to ZERO. The waveform generator output is set on compare match when up-counting, and cleared on compare match when down-counting. An interrupt/event is generated on TOP and/or ZERO, depend of Dual slope.

In DSBOTH operation, a second update time occurs on TOP when circular buffer is enabled.

**Figure 36-7. Dual-Slope Pulse Width Modulation**



Using dual-slope PWM results in a lower maximum operation frequency compared to single-slope PWM generation. The period (TOP) defines the PWM resolution. The minimum resolution is 1 bit (TOP=0x00000001).

The following equation calculates the exact resolution for dual-slope PWM ( $R_{P_{PWM\_DS}}$ ):

$$R_{P_{PWM\_DS}} = \frac{\log(PER+1)}{\log(2)}$$

The PWM frequency  $f_{P_{PWM\_DS}}$  depends on the period setting (TOP) and the peripheral clock frequency  $f_{GCLK\_TCC}$ , and can be calculated by the following equation:

$$f_{P_{PWM\_DS}} = \frac{f_{GCLK\_TCC}}{2N \cdot PER}$$

$N$  represents the prescaler divider used. The waveform generated will have a maximum frequency of half of the TCC clock frequency ( $f_{GCLK\_TCC}$ ) when TOP is set to 0x00000001 and no prescaling is used.

The pulse width ( $P_{P_{PWM\_DS}}$ ) depends on the compare channel (CCx) register value and the peripheral clock frequency ( $f_{GCLK\_TCC}$ ), and can be calculated by the following equation:

$$P_{P_{PWM\_DS}} = \frac{2N \cdot (TOP - CCx)}{f_{GCLK\_TCC}}$$

$N$  represents the prescaler divider used.

**Note:** In DSTOP, DSBOTTOM and DS BOTH operation, when TOP is lower than MAX/2, the CCx MSB bit defines the ramp on which the CCx Match interrupt or event is generated. (Rising if CCx[MSB]=0, falling if CCx[MSB]=1.)

### Related Links

[Circular Buffer](#)

### Dual-Slope Critical PWM Generation

Critical mode generation allows generation of non-aligned centered pulses. In this mode, the period time is controlled by PER while CCx control the generated waveform output edge during up-counting and CC(x+CC\_NUM/2) control the generated waveform output edge during down-counting.

**Figure 36-8. Dual-Slope Critical Pulse Width Modulation (N=CC\_NUM)**

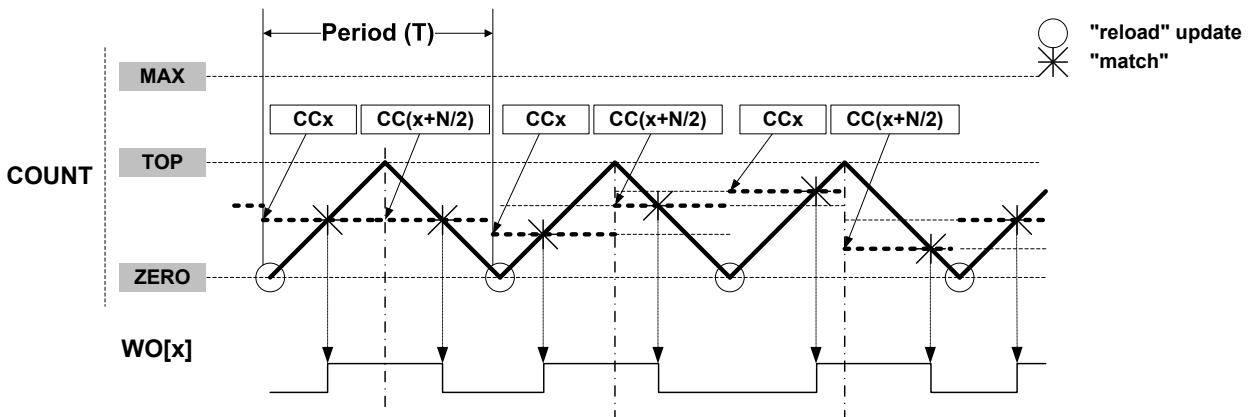

### Output Polarity

The polarity (WAVE.POLx) is available in all waveform output generation. In single-slope and dual-slope PWM operation, it is possible to invert the pulse edge alignment individually on start or end of a PWM cycle for each compare channels. The table below shows the waveform output set/clear conditions, depending on the settings of timer/counter, direction, and polarity.

**Table 36-3. Waveform Generation Set/Clear Conditions**

Waveform Generation operation	DIR	POLx	Waveform Generation Output Update	
			Set	Clear
Single-Slope PWM	0	0	Timer/counter matches TOP	Timer/counter matches CCx
		1	Timer/counter matches CC	Timer/counter matches TOP
	1	0	Timer/counter matches CC	Timer/counter matches ZERO
		1	Timer/counter matches ZERO	Timer/counter matches CC
Dual-Slope PWM	x	0	Timer/counter matches CC when counting up	Timer/counter matches CC when counting down
		1	Timer/counter matches CC when counting down	Timer/counter matches CC when counting up

In Normal and Match Frequency, the WAVE.POLx value represents the initial state of the waveform output.

### 36.6.2.6 Double Buffering

The Pattern (PATT), Waveform (WAVE), Period (PER) and Compare Channels (CCx) registers are all double buffered. Each buffer register has a buffer valid (PATTBUFV, WAVEBUFV, PERBUFV or CCBUFVx) bit in the STATUS register, which indicates that the buffer register contains a valid value that can be copied into the corresponding register. .

When the buffer valid flag bit in the STATUS register is '1' and the Lock Update bit in the CTRLB register is set to '0', (writing CTRLBCLR.LUPD to '1'), double buffering is enabled: the data from buffer registers will be copied into the corresponding register under hardware UPDATE conditions, then the buffer valid flags bit in the STATUS register are automatically cleared by hardware.

**Note:** Software update command (CTRLBSET.CMD=0x3) act independently of LUPD value.

A compare register is double buffered as in the following figure.

Figure 36-9. Compare Channel Double Buffering



Both the registers (PATT/WAVE/PER/CCx) and corresponding buffer registers (PATTBUF/WAVEBUFV/PERBUF/CCBUFx) are available in the I/O register map, and the double buffering feature is not mandatory. The double buffering is disabled by writing a '1' to CTRLSET.LUPD.

**Note:** In NFRQ, MFRQ or PWM down-counting counter mode (CTRLBSET.DIR=1), when double buffering is enabled (CTRLBCLR.LUPD=1), PERBUF register is continuously copied into the PER independently of update conditions.

**Changing the Period**

The counter period can be changed by writing a new Top value to the Period register (PER or CC0, depending on the waveform generation mode), any period update on registers (PER or CCx) is effective after the synchronization delay, whatever double buffering enabling is.

Figure 36-10. Unbuffered Single-Slope Up-Counting Operation



Figure 36-11. Unbuffered Single-Slope Down-Counting Operation

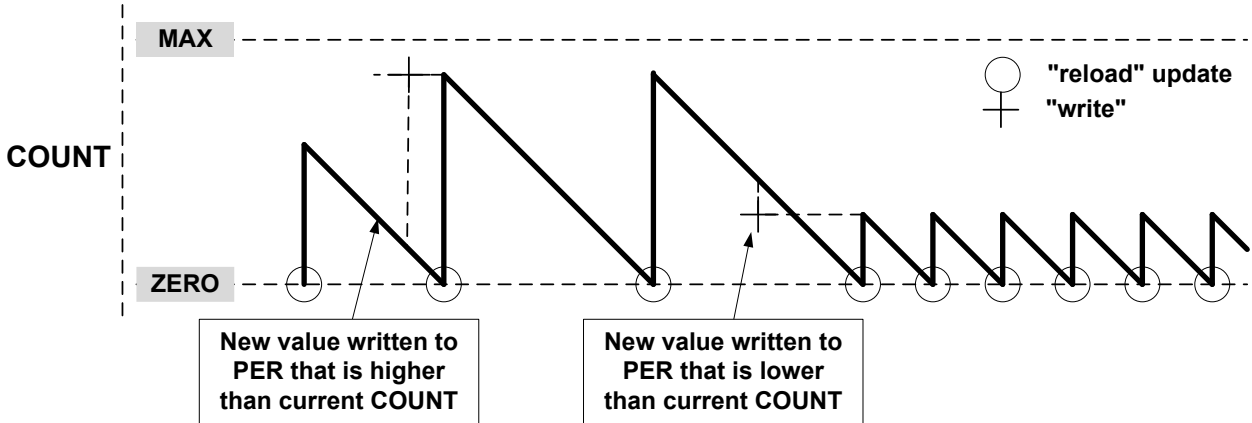

A counter wraparound can occur in any operation mode when up-counting without buffering, see [Figure 36-10](#). COUNT and TOP are continuously compared, so when a new value that is lower than the current COUNT is written to TOP, COUNT will wrap before a compare match.

Figure 36-12. Unbuffered Dual-Slope Operation



When double buffering is used, the buffer can be written at any time and the counter will still maintain correct operation. The period register is always updated on the update condition, as shown in [Figure 36-13](#). This prevents wraparound and the generation of odd waveforms.

Figure 36-13. Changing the Period Using Buffering



36.6.2.7 Capture Operations

To enable and use capture operations, the Match or Capture Channel x Event Input Enable bit in the Event Control register (EVCTRL.MCEIx) must be written to '1'. The capture channels to be used must also be enabled in the Capture Channel x Enable bit in the Control A register (CTRLA.CPTENx) before capturing can be performed.

Event Capture Action

The compare/capture channels can be used as input capture channels to capture events from the Event System, and give them a timestamp. The following figure shows four capture events for one capture channel.

Figure 36-14. Input Capture Timing



For input capture, the buffer register and the corresponding CCx act like a FIFO. When CCx is empty or read, any content in CCBUFx is transferred to CCx. The buffer valid flag is passed to set the CCx interrupt flag (IF) and generate the optional interrupt, event or DMA request. CCBUFx register value can't be read, all captured data must be read from CCx register.

Figure 36-15. Capture Double Buffering

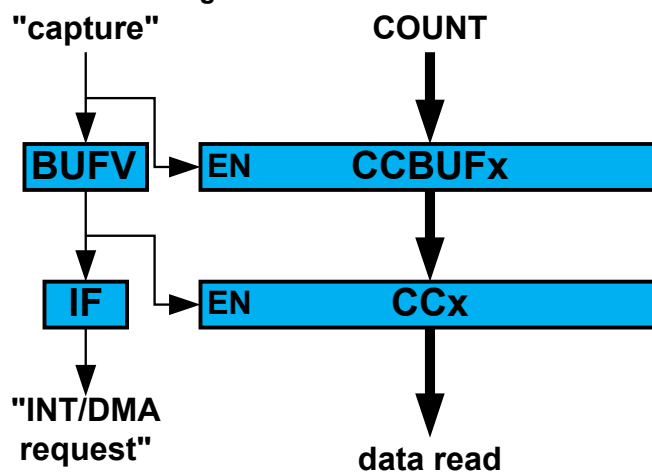

The TCC can detect capture overflow of the input capture channels: When a new capture event is detected while the Capture Buffer Valid flag (STATUS.CCBUFV) is still set, the new timestamp will not be stored and INTFLAG.ERR will be set.

Period and Pulse-Width (PPW) Capture Action



The TCC can perform two input captures and restart the counter on one of the edges. This enables the TCC to measure the pulse-width and period and to characterize the frequency  $f$  and  $dutyCycle$  of an input signal:

$$f = \frac{1}{T} \quad , \quad dutyCycle = \frac{t_p}{T}$$

**Figure 36-16. PWP Capture**



Selecting PWP or PPW in the Timer/Counter Event Input 1 Action bit group in the Event Control register (EVCTRL.EVACT1) enables the TCC to perform one capture action on the rising edge and the other one on the falling edge. When using PPW (period and pulse-width) event action, period  $T$  will be captured into CC0 and the pulse-width  $t_p$  into CC1. The PWP (Pulse-width and Period) event action offers the same functionality, but  $T$  will be captured into CC1 and  $t_p$  into CC0.

The Timer/Counter Event  $x$  Invert Enable bit in Event Control register (EVCTRL.TCEINV $x$ ) is used for event source  $x$  to select whether the wraparound should occur on the rising edge or the falling edge. If EVCTRL.TCEINV $x$ =1, the wraparound will happen on the falling edge.

The corresponding capture is done only if the channel is enabled in capture mode (CTRLA.CPTEN $x$ =1). If not, the capture action will be ignored and the channel will be enabled in compare mode of operation. When only one of these channel is required, the other channel can be used for other purposes.

The TCC can detect capture overflow of the input capture channels: When a new capture event is detected while the INTFLAG.MC $x$  is still set, the new timestamp will not be stored and INTFLAG.ERR will be set.

**Note:** When up-counting (CTRLBSET.DIR=0), counter values lower than 1 cannot be captured in Capture Minimum mode (FCTRLn.CAPTURE=CAPTMIN). To capture the full range including value 0, the TCC must be configured in down-counting mode (CTRLBSET.DIR=0).

**Note:** In dual-slope PWM operation, and when TOP is lower than MAX/2, the CC $x$  MSB captures the CTRLB.DIR state to identify the ramp on which the capture has been done. For rising ramps CC $x$ [MSB] is zero, for falling ramps CC $x$ [MSB]=1.

### 36.6.3 Additional Features

#### 36.6.3.1 One-Shot Operation

When one-shot is enabled, the counter automatically stops on the next counter overflow or underflow condition. When the counter is stopped, the Stop bit in the Status register (STATUS.STOP) is set and the waveform outputs are set to the value defined by DRVCTRL.NRE $x$  and DRVCTRL.NRV $x$ .

One-shot operation can be enabled by writing a '1' to the One-Shot bit in the Control B Set register (CTRLBSET.ONESHOT) and disabled by writing a '1' to CTRLBCLR.ONESHOT. When enabled, the TCC will count until an overflow or underflow occurs and stop counting. The one-shot operation can be restarted by a re-trigger software command, a re-trigger event or a start event. When the counter restarts its operation, STATUS.STOP is automatically cleared.

### 36.6.3.2 Circular Buffer

The Period register (PER) and the compare channels register (CC0 to CC3) support circular buffer operation. When circular buffer operation is enabled, the PER or CCx values are copied into the corresponding buffer registers at each update condition. Circular buffering is dedicated to RAMP2, RAMP2A, and DSBOOTH operations.

**Figure 36-17. Circular Buffer on Channel 0**



### 36.6.3.3 Dithering Operation

The TCC supports dithering on Pulse-width or Period on a 16, 32 or 64 PWM cycles frame.

Dithering consists in adding some extra clock cycles in a frame of several PWM cycles, and can improve the accuracy of the *average* output pulse width and period. The extra clock cycles are added on some of the compare match signals, one at a time, through a "blue noise" process that minimizes the flickering on the resulting dither patterns.

Dithering is enabled by writing the corresponding configuration in the Enhanced Resolution bits in CTRLA register (CTRLA.RESOLUTION):

- DITH4 enable dithering every 16 PWM frames
- DITH5 enable dithering every 32 PWM frames
- DITH6 enable dithering every 64 PWM frames

The DITHERCY bits of COUNT, PER and CCx define the number of extra cycles to add into the frame (DITHERCY bits from the respective COUNT, PER or CCx registers). The remaining bits of COUNT, PER, CCx define the compare value itself.

The pseudo code, giving the extra cycles insertion regarding the cycle is:

```
int extra_cycle(resolution, dithercy, cycle){
    int MASK;
    int value
    switch (resolution){
        DITH4: MASK = 0x0f;
        DITH5: MASK = 0x1f;
        DITH6: MASK = 0x3f;
    }
}
```

```

value = cycle * dithercy;
if ((MASK & value) + dithercy) > MASK)
    return 1;
return 0;
}

```

## Dithering on Period

Writing DITHERCY in PER will lead to an average PWM period configured by the following formulas.

DITH4 mode:

$$PwmPeriod = \left( \frac{DITHERCY}{16} + PER \right) \left( \frac{1}{f_{GCLK\_TCC}} \right)$$

**Note:** If DITH4 mode is enabled, the last 4 significant bits from PER/CCx or COUNT register correspond to the DITHERCY value, rest of the bits corresponds to PER/CCx or COUNT value.

DITH5 mode:

$$PwmPeriod = \left( \frac{DITHERCY}{32} + PER \right) \left( \frac{1}{f_{GCLK\_TCC}} \right)$$

DITH6 mode:

$$PwmPeriod = \left( \frac{DITHERCY}{64} + PER \right) \left( \frac{1}{f_{GCLK\_TCC}} \right)$$

## Dithering on Pulse Width

Writing DITHERCY in CCx will lead to an average PWM pulse width configured by the following formula.

DITH4 mode:

$$PwmPulseWidth = \left( \frac{DITHERCY}{16} + CCx \right) \left( \frac{1}{f_{GCLK\_TCC}} \right)$$

DITH5 mode:

$$PwmPulseWidth = \left( \frac{DITHERCY}{32} + CCx \right) \left( \frac{1}{f_{GCLK\_TCC}} \right)$$

DITH6 mode:

$$PwmPulseWidth = \left( \frac{DITHERCY}{64} + CCx \right) \left( \frac{1}{f_{GCLK\_TCC}} \right)$$

**Note:** The PWM period will remain static in this case.

### 36.6.3.4 Ramp Operations

Three ramp operation modes are supported. All of them require the timer/counter running in single-slope PWM generation. The ramp mode is selected by writing to the Ramp Mode bits in the Waveform Control register (WAVE.RAMP).

#### RAMP1 Operation

This is the default PWM operation, described in [Single-Slope PWM Generation](#).

#### RAMP2 Operation

These operation modes are dedicated for power factor correction (PFC), Half-Bridge and Push-Pull SMPS topologies, where two consecutive timer/counter cycles are interleaved, see [Figure 36-18](#). In cycle

A, odd channel output is disabled, and in cycle B, even channel output is disabled. The ramp index changes after each update, but can be software modified using the Ramp index command bits in Control B Set register (CTRLBSET.IDXCMD).

## Standard RAMP2 (RAMP2) Operation

Ramp A and B periods are controlled by the PER register value. The PER value can be different on each ramp by the Circular Period buffer option in the Wave register (WAVE.CIPEREN=1). This mode uses a two-channel TCC to generate two output signals, or one output signal with another CC channel enabled in capture mode.

**Figure 36-18. RAMP2 Standard Operation**



## Alternate RAMP2 (RAMP2A) Operation

Alternate RAMP2 operation is similar to RAMP2, but CC0 controls both WO[0] and WO[1] waveforms when the corresponding circular buffer option is enabled (CIPEREN=1). The waveform polarity is the same on both outputs. Channel 1 can be used in capture mode.

**Figure 36-19. RAMP2 Alternate Operation**



**Critical RAMP2 (RAMP2C) Operation**

Critical RAMP2 operation provides a way to cover RAMP2 operation requirements without the update constraint associated to the use of circular buffers. In this mode, CC0 is controlling the period of ramp A and PER is controlling the period of ramp B. When using more than two channels, WO[0] output is controlled by CC2 (HIGH) and CC0 (LOW). On TCC with 2 channels, a pulse on WO[0] will last the entire period of ramp A, if WAVE.POL0=0.

**Figure 36-20. RAMP2 Critical Operation With More Than 2 Channels**



**Figure 36-21. RAMP2 Critical Operation With 2 Channels**



**36.6.3.5 Recoverable Faults**

Recoverable faults can restart or halt the timer/counter. Two faults, called Fault A and Fault B, can trigger recoverable fault actions on the compare channels CC0 and CC1 of the TCC. The compare channels' outputs can be clamped to inactive state either as long as the fault condition is present, or from the first valid fault condition detection on until the end of the timer/counter cycle.

## Fault Inputs

The first two channel input events (TCCxMC0 and TCCxMC1) can be used as Fault A and Fault B inputs, respectively. Event system channels connected to these fault inputs must be configured as asynchronous. The TCC must work in a PWM mode.

## Fault Filtering

There are three filters available for each input Fault A and Fault B. They are configured by the corresponding Recoverable Fault n Configuration registers (FCTRLA and FCTRLB). The three filters can either be used independently or in any combination.

**Input Filtering** By default, the event detection is asynchronous. When the event occurs, the fault system will immediately and asynchronously perform the selected fault action on the compare channel output, also in device power modes where the clock is not available. To avoid false fault detection on external events (e.g. due to a glitch on an I/O port) a digital filter can be enabled and configured by the Fault B Filter Value bits in the Fault n Configuration registers (FCTRLn.FILTERVAL). If the event width is less than FILTERVAL (in clock cycles), the event will be discarded. A valid event will be delayed by FILTERVAL clock cycles.

**Fault Blanking** This ignores any fault input for a certain time just after a selected waveform output edge. This can be used to prevent false fault triggering due to signal bouncing, as shown in the figure below. Blanking can be enabled by writing an edge triggering configuration to the Fault n Blanking Mode bits in the Recoverable Fault n Configuration register (FCTRLn.BLANK). The desired duration of the blanking must be written to the Fault n Blanking Time bits (FCTRLn.BLANKVAL).

The blanking time  $t_b$  is calculated by

$$t_b = \frac{1 + \text{BLANKVAL}}{f_{\text{GCLK\_TCCx\_PRESC}}}$$

Here,  $f_{\text{GCLK\_TCCx\_PRESC}}$  is the frequency of the prescaled peripheral clock frequency  $f_{\text{GCLK\_TCCx}}$ .

The maximum blanking time (FCTRLn.BLANKVAL=255) at  $f_{\text{GCLK\_TCCx}}=96\text{MHz}$  is  $2.67\mu\text{s}$  (no prescaler) or  $170\mu\text{s}$  (prescaling). For  $f_{\text{GCLK\_TCCx}}=1\text{MHz}$ , the maximum blanking time is either  $170\mu\text{s}$  (no prescaling) or  $10.9\text{ms}$  (prescaling enabled).

**Figure 36-22. Fault Blanking in RAMP1 Operation with Inverted Polarity**



**Fault Qualification** This is enabled by writing a '1' to the Fault n Qualification bit in the Recoverable Fault n Configuration register (FCTRLn.QUAL). When the recoverable fault qualification is enabled (FCTRLn.QUAL=1), the fault input is disabled all the time the corresponding channel output has an inactive level, as shown in the figures below.

**Figure 36-23. Fault Qualification in RAMP1 Operation**



**Figure 36-24. Fault Qualification in RAMP2 Operation with Inverted Polarity**



**Fault Actions**

Different fault actions can be configured individually for Fault A and Fault B. Most fault actions are not mutually exclusive; hence two or more actions can be enabled at the same time to achieve a result that is a combination of fault actions.

**Keep Action** This is enabled by writing the Fault n Keeper bit in the Recoverable Fault n Configuration register (FCTRLn.KEEP) to '1'. When enabled, the corresponding channel output will be clamped to zero as long as the fault condition is present. The clamp will be released on the start of the first cycle after the fault condition is no longer present, see next Figure.

**Figure 36-25. Waveform Generation with Fault Qualification and Keep Action**



**Restart Action** This is enabled by writing the Fault n Restart bit in Recoverable Fault n Configuration register (FCTRLn.RESTART) to '1'. When enabled, the timer/counter will be restarted as soon as the corresponding fault condition is present. The ongoing cycle is stopped and the timer/counter starts a new cycle, see Figure 36-26. In Ramp 1 mode, when the new cycle starts, the compare outputs will be clamped to inactive level as long as the fault condition is present.

**Note:** For RAMP2 operation, when a new timer/counter cycle starts the cycle index will change automatically, see Figure 36-27. Fault A and Fault B are qualified only during the cycle A and cycle B respectively: Fault A is disabled during cycle B, and Fault B is disabled during cycle A.

**Figure 36-26. Waveform Generation in RAMP1 mode with Restart Action**





Figure 36-27. Waveform Generation in RAMP2 mode with Restart Action



**Capture Action** Several capture actions can be selected by writing the Fault n Capture Action bits in the Fault n Control register (FCTRLn.CAPTURE). When one of the capture operations is selected, the counter value is captured when the fault occurs. These capture operations are available:

- CAPT - the equivalent to a standard capture operation, for further details refer to [Capture Operations](#)
- CAPTMIN - gets the minimum time stamped value: on each new local minimum captured value, an event or interrupt is issued.
- CAPTMAX - gets the maximum time stamped value: on each new local maximum captured value, an event or interrupt (IT) is issued, see [Figure 36-28](#).
- LOCMIN - notifies by event or interrupt when a local minimum captured value is detected.
- LOCMAX - notifies by event or interrupt when a local maximum captured value is detected.
- DERIV0 - notifies by event or interrupt when a local extreme captured value is detected, see [Figure 36-29](#).

*CCx Content:*

In CAPTMIN and CAPTMAX operations, CCx keeps the respective extremum captured values, see [Figure 36-28](#). In LOCMIN, LOCMAX or DERIV0 operation, CCx follows the counter value at fault time, see [Figure 36-29](#).

Before enabling CAPTMIN or CAPTMAX mode of capture, the user must initialize the corresponding CCx register value to a value different from zero (for CAPTMIN) top (for CAPTMAX). If the CCx register initial value is zero (for CAPTMIN) top (for CAPTMAX), no captures will be performed using the corresponding channel.

*MCx Behaviour:*

In LOCMIN and LOCMAX operation, capture is performed on each capture event. The MCx interrupt flag is set only when the captured value is upper or equal (for LOCMIN) or lower or equal (for LOCMAX) to the previous captured value. So interrupt flag is set when a new

relative local Minimum (for CAPTMIN) or Maximum (for CAPTMAX) value has been detected. DERIV0 is equivalent to an OR function of (LOCMIN, LOCMAx).

In CAPT operation, capture is performed on each capture event. The MCx interrupt flag is set on each new capture.

In CAPTMIN and CAPTMAX operation, capture is performed only when on capture event time, the counter value is lower (for CAPTMIN) or upper (for CAPMAX) than the last captured value. The MCx interrupt flag is set only when on capture event time, the counter value is upper or equal (for CAPTMIN) or lower or equal (for CAPTMAX) to the value captured on the previous event. So interrupt flag is set when a new absolute local Minimum (for CAPTMIN) or Maximum (for CAPTMAX) value has been detected.

### Interrupt Generation

In CAPT mode, an interrupt is generated on each filtered Fault n and each dedicated CCx channel capture counter value. In other modes, an interrupt is only generated on an extreme captured value.

**Figure 36-28. Capture Action “CAPTMAX”**



**Figure 36-29. Capture Action “DERIV0”**



**Hardware Halt Action** This is configured by writing 0x1 to the Fault n Halt mode bits in the Recoverable Fault n Configuration register (FCTRLn.HALT). When enabled, the timer/counter is halted and the cycle is extended as long as the corresponding fault is present.

The next figure ('Waveform Generation with Halt and Restart Actions') shows an example where both restart action and hardware halt action are enabled for Fault A. The compare channel 0 output is clamped to inactive level as long as the timer/counter is halted. The timer/counter resumes the counting operation as soon as the fault condition is no longer present. As the restart action is enabled in this example, the timer/counter is restarted after the fault condition is no longer present.

The figure after that ('Waveform Generation with Fault Qualification, Halt, and Restart Actions') shows a similar example, but with additionally enabled fault qualification. Here, counting is resumed after the fault condition is no longer present.

Note that in RAMP2 and RAMP2A operations, when a new timer/counter cycle starts, the cycle index will automatically change.

**Figure 36-30. Waveform Generation with Halt and Restart Actions**



**Figure 36-31. Waveform Generation with Fault Qualification, Halt, and Restart Actions**

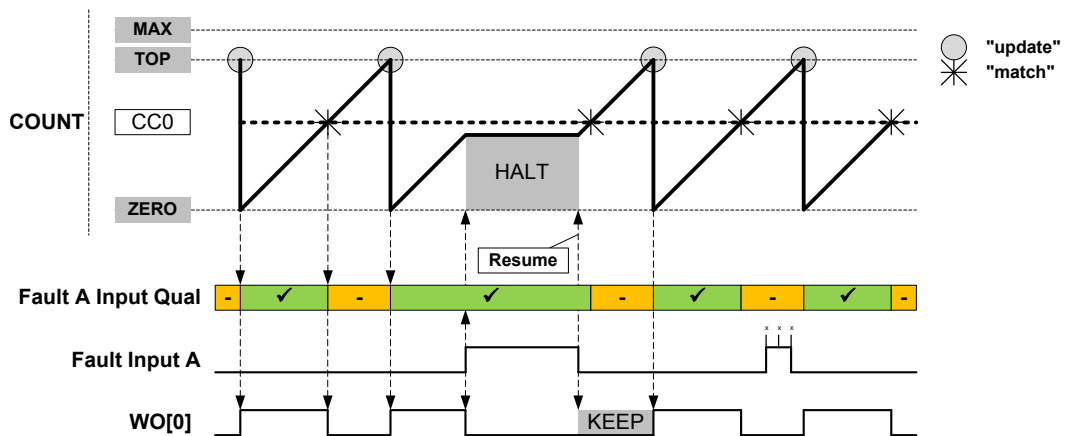

**Software Halt Action**

This is configured by writing 0x2 to the Fault n Halt mode bits in the Recoverable Fault n configuration register (FCTRLn.HALT). Software halt action is similar to hardware halt action, but in order to restart the timer/counter, the corresponding fault condition must not be present anymore, and the corresponding FAULT n bit in the STATUS register must be cleared by software.

Figure 36-32. Waveform Generation with Software Halt, Fault Qualification, Keep and Restart Actions



### 36.6.3.6 Non-Recoverable Faults

The non-recoverable fault action will force all the compare outputs to a pre-defined level programmed into the Driver Control register (DRVCTRL.NRE and DRVCTRL.NRV). The non-recoverable fault input (EV0 and EV1) actions are enabled in Event Control register (EVCTRL.EVACT0 and EVCTRL.EVACT1).

To avoid false fault detection on external events (e.g. a glitch on an I/O port) a digital filter can be enabled using Non-Recoverable Fault Input x Filter Value bits in the Driver Control register (DRVCTRL.FILTERVALn). Therefore, the event detection is synchronous, and event action is delayed by the selected digital filter value clock cycles.

When the Fault Detection on Debug Break Detection bit in Debug Control register (DGBCTRL.FDDBD) is written to '1', a non-recoverable Debug Faults State and an interrupt (DFS) is generated when the system goes in debug operation.

In RAMP2, RAMP2A, or DSBOTH operation, when the Lock Update bit in the Control B register is set by writing CTRLBSET.LUPD=1 and the ramp index or counter direction changes, a non-recoverable Update Fault State and the respective interrupt (UFS) are generated.

### 36.6.3.7 Waveform Extension

Figure 36-33 shows a schematic diagram of actions of the four optional units that follow the recoverable fault stage on a port pin pair: Output Matrix (OTMX), Dead-Time Insertion (DTI), SWAP and Pattern Generation. The DTI and SWAP units can be seen as a four port pair slices:

- Slice 0 DTI0 / SWAP0 acting on port pins (WO[0], WO[WO\_NUM/2 +0])
- Slice 1 DTI1 / SWAP1 acting on port pins (WO[1], WO[WO\_NUM/2 +1])

And more generally:

- Slice n DTIx / SWAPx acting on port pins (WO[x], WO[WO\_NUM/2 +x])

**Figure 36-33. Waveform Extension Stage Details**



The output matrix (OTMX) unit distributes compare channels, according to the selectable configurations in [Table 36-4](#).

**Table 36-4. Output Matrix Channel Pin Routing Configuration**

Value	OTMX[x]							
0x0	CC3	CC2	CC1	CC0	CC3	CC2	CC1	CC0
0x1	CC1	CC0	CC1	CC0	CC1	CC0	CC1	CC0
0x2	CC0	CC0	CC0	CC0	CC0	CC0	CC0	CC0
0x3	CC1	CC1	CC1	CC1	CC1	CC1	CC1	CC0

Notes on [Table 36-4](#):

- Configuration 0x0 is the default configuration. The channel location is the default one, and channels are distributed on outputs modulo the number of channels. Channel 0 is routed to the Output matrix output OTMX[0], and Channel 1 to OTMX[1]. If there are more outputs than channels, then channel 0 is duplicated to the Output matrix output OTMX[CC\_NUM], channel 1 to OTMX[CC\_NUM+1] and so on.
- Configuration 0x1 distributes the channels on output modulo half the number of channels. This assigns twice the number of output locations to the lower channels than the default configuration. This can be used, for example, to control the four transistors of a full bridge using only two compare channels. Using pattern generation, some of these four outputs can be overwritten by a constant level, enabling flexible drive of a full bridge in all quadrant configurations.
- Configuration 0x2 distributes compare channel 0 (CC0) to all port pins. With pattern generation, this configuration can control a stepper motor.
- Configuration 0x3 distributes the compare channel CC0 to the first output, and the channel CC1 to all other outputs. Together with pattern generation and the fault extension, this configuration can control up to seven LED strings, with a boost stage.

**Table 36-5. Example: four compare channels on four outputs**

Value	OTMX[3]	OTMX[2]	OTMX[1]	OTMX[0]
0x0	CC3	CC2	CC1	CC0
0x1	CC1	CC0	CC1	CC0

Value	OTMX[3]	OTMX[2]	OTMX[1]	OTMX[0]
0x2	CC0	CC0	CC0	CC0
0x3	CC1	CC1	CC1	CC0

The **dead-time insertion (DTI)** unit generates OFF time with the non-inverted low side (LS) and inverted high side (HS) of the wave generator output forced at low level. This OFF time is called dead time. Dead-time insertion ensures that the LS and HS will never switch simultaneously.

The DTI stage consists of four equal dead-time insertion generators; one for each of the first four compare channels. [Figure 36-34](#) shows the block diagram of one DTI generator. The four channels have a common register which controls the dead time, which is independent of high side and low side setting.

**Figure 36-34. Dead-Time Generator Block Diagram**



As shown in [Figure 36-35](#), the 8-bit dead-time counter is decremented by one for each peripheral clock cycle until it reaches zero. A non-zero counter value will force both the low side and high side outputs into their OFF state. When the output matrix (OTMX) output changes, the dead-time counter is reloaded according to the edge of the input. When the output changes from low to high (positive edge) it initiates a counter reload of the DTLS register. When the output changes from high to low (negative edge) it reloads the DTHS register.

**Figure 36-35. Dead-Time Generator Timing Diagram**



The **pattern generator unit** produces a synchronized bit pattern across the port pins it is connected to. The pattern generation features are primarily intended for handling the commutation sequence in brushless DC motors (BLDC), stepper motors, and full bridge control. See also [Figure 36-36](#).

**Figure 36-36. Pattern Generator Block Diagram**



As with other double-buffered timer/counter registers, the register update is synchronized to the UPDATE condition set by the timer/counter waveform generation operation. If synchronization is not required by the application, the software can simply access directly the PATT.PGE, PATT.PGV bits registers.

### 36.6.4 Master/Slave Operation

Two TCC instances sharing the same GCLK\_TCC clock, can be linked to provide more synchronized CC channels. The operation is enabled by setting the Master Synchronization bit in Control A register (CTRLA.MSYNC) in the Slave instance. When the bit is set, the slave TCC instance will synchronize the CC channels to the Master counter.

#### Related Links

[CTRLA](#)

### 36.6.5 DMA, Interrupts, and Events

**Table 36-6. Module Requests for TCC**

Condition	Interrupt request	Event output	Event input	DMA request	DMA request is cleared
Overflow / Underflow	Yes	Yes		Yes <sup>(1)</sup>	On DMA acknowledge
Channel Compare Match or Capture	Yes	Yes	Yes <sup>(2)</sup>	Yes <sup>(3)</sup>	For circular buffering: on DMA acknowledge For capture channel: when CCx register is read
Retrigger	Yes	Yes			
Count	Yes	Yes			

Condition	Interrupt request	Event output	Event input	DMA request	DMA request is cleared
Capture Overflow Error	Yes				
Debug Fault State	Yes				
Recoverable Faults	Yes				
Non-Recoverable Faults	Yes				
TCCx Event 0 input			Yes <sup>(4)</sup>		
TCCx Event 1 input			Yes <sup>(5)</sup>		

**Notes:**

1. DMA request set on overflow, underflow or re-trigger conditions.
2. Can perform capture or generate recoverable fault on an event input.
3. In capture or circular modes.
4. On event input, either action can be executed:
  - re-trigger counter
  - control counter direction
  - stop the counter
  - decrement the counter
  - perform period and pulse width capture
  - generate non-recoverable fault
5. On event input, either action can be executed:
  - re-trigger counter
  - increment or decrement counter depending on direction
  - start the counter
  - increment or decrement counter based on direction
  - increment counter regardless of direction
  - generate non-recoverable fault

### 36.6.5.1 DMA Operation

The TCC can generate the following DMA requests:

**Counter overflow (OVF)** If the Ones-shot Trigger mode in the control A register (CTRLA.DMAOS) is written to '0', the TCC generates a DMA request on each cycle when an update condition (overflow, underflow or re-trigger) is detected.

When an update condition (overflow, underflow or re-trigger) is detected while CTRLA.DMAOS=1, the TCC generates a DMA trigger on the cycle following the DMA One-Shot Command written to the Control B register (CTRLBSET.CMD=DMAOS).

In both cases, the request is cleared by hardware on DMA acknowledge.

**Channel Match (MCx)** A DMA request is set only on a compare match if CTRLA.DMAOS=0. The request is cleared by hardware on DMA acknowledge.

When CTRLA.DMAOS=1, the DMA requests are not generated.



**Channel Capture (MCx)** For a capture channel, the request is set when valid data is present in the CCx register, and cleared once the CCx register is read.  
 In this operation mode, the CTRLA.DMAOS bit value is ignored.

### DMA Operation with Circular Buffer

When circular buffer operation is enabled, the buffer registers must be written in a correct order and synchronized to the update times of the timer. The DMA triggers of the TCC provide a way to ensure a safe and correct update of circular buffers.

**Note:** Circular buffer are intended to be used with RAMP2, RAMP2A and DSBOTH operation only.

#### DMA Operation with Circular Buffer in RAMP and RAMP2A Mode

When a CCx channel is selected as a circular buffer, the related DMA request is not set on a compare match detection, but on start of ramp B.

If at least one circular buffer is enabled, the DMA overflow request is conditioned to the start of ramp A with an effective DMA transfer on previous ramp B (DMA acknowledge).

The update of all circular buffer values for ramp A can be done through a DMA channel triggered on a MC trigger. The update of all circular buffer values for ramp B, can be done through a second DMA channel triggered by the overflow DMA request.

**Figure 36-37. DMA Triggers in RAMP and RAMP2 Operation Mode and Circular Buffer Enabled**



#### DMA Operation with Circular Buffer in DSBOTH Mode

When a CC channel is selected as a circular buffer, the related DMA request is not set on a compare match detection, but on start of down-counting phase.

If at least one circular buffer is enabled, the DMA overflow request is conditioned to the start of up-counting phase with an effective DMA transfer on previous down-counting phase (DMA acknowledge).

When up-counting, all circular buffer values can be updated through a DMA channel triggered by MC trigger. When down-counting, all circular buffer values can be updated through a second DMA channel, triggered by the OVF DMA request.

Figure 36-38. DMA Triggers in DSBOTH Operation Mode and Circular Buffer Enabled



### 36.6.5.2 Interrupts

The TCC has the following interrupt sources:

- Overflow/Underflow (OVF)
- Retrigger (TRG)
- Count (CNT) - refer also to description of [EVCTRL.CNTSEL](#).
- Capture Overflow Error (ERR)
- Non-Recoverable Update Fault (UFS)
- Debug Fault State (DFS)
- Recoverable Faults (FAULTn)
- Non-recoverable Faults (FAULTx)
- Compare Match or Capture Channels (MCx)

These interrupts are asynchronous wake-up sources. See Sleep Mode Entry and Exit Table in PM/Sleep Mode Controller section for details.

Each interrupt source has an interrupt flag associated with it. The interrupt flag in the Interrupt Flag Status and Clear (INTFLAG) register is set when the interrupt condition occurs. Each interrupt can be individually enabled by writing a '1' to the corresponding bit in the Interrupt Enable Set (INTENSET) register, and disabled by writing a '1' to the corresponding bit in the Interrupt Enable Clear (INTENCLR) register. An interrupt request is generated when the interrupt flag is set and the corresponding interrupt is enabled. The interrupt request remains active until the interrupt flag is cleared, the interrupt is disabled, or the TCC is reset. See [INTFLAG](#) for details on how to clear interrupt flags. The TCC has one common interrupt request line for all the interrupt sources. The user must read the INTFLAG register to determine which interrupt condition is present.

Note: Interrupts must be globally enabled for interrupt requests to be generated. Refer to *Nested Vector Interrupt Controller* for details.

#### Related Links

- [Nested Vector Interrupt Controller](#)
- [Sleep Mode Controller](#)

### 36.6.5.3 Events

The TCC can generate the following output events:

- Overflow/Underflow (OVF)
- Trigger (TRG)
- Counter (CNT) For further details, refer to [EVCTRL.CNTSEL](#) description.
- Compare Match or Capture on compare/capture channels: MCx

Writing a '1' ('0') to an Event Output bit in the Event Control Register (EVCTRL.xxEO) enables (disables) the corresponding output event. Refer also to *EVSYS – Event System*.

The TCC can take the following actions on a channel input event (MCx):

- Capture event
- Generate a recoverable or non-recoverable fault

The TCC can take the following actions on counter Event 1 (TCCx EV1):

- Counter re-trigger
- Counter direction control
- Stop the counter
- Decrement the counter on event
- Period and pulse width capture
- Non-recoverable fault

The TCC can take the following actions on counter Event 0 (TCCx EV0):

- Counter re-trigger
- Count on event (increment or decrement, depending on counter direction)
- Counter start - start counting on the event rising edge. Further events will not restart the counter; the counter will keep on counting using prescaled GCLK\_TCCx, until it reaches TOP or ZERO, depending on the direction.
- Counter increment on event. This will increment the counter, irrespective of the counter direction.
- Count during active state of an asynchronous event (increment or decrement, depending on counter direction). In this case, the counter will be incremented or decremented on each cycle of the prescaled clock, as long as the event is active.
- Non-recoverable fault

The counter Event Actions are available in the Event Control registers (EVCTRL.EVACT0 and EVCTRL.EVACT1). For further details, refer to [EVCTRL](#).

Writing a '1' ('0') to an Event Input bit in the Event Control register (EVCTRL.MCEIx or EVCTRL.TCEIx) enables (disables) the corresponding action on input event.

**Note:** When several events are connected to the TCC, the enabled action will apply for each of the incoming events. Refer to *EVSYS – Event System* for details on how to configure the event system.

## Related Links

[EVSYS – Event System](#)

### 36.6.6 Sleep Mode Operation

The TCC can be configured to operate in any sleep mode. To be able to run in standby the RUNSTDBY bit in the Control A register (CTRLA.RUNSTDBY) must be '1'. The MODULE can in any sleep mode wake up the device using interrupts or perform actions through the Event System.

### 36.6.7 Synchronization

Due to asynchronicity between the main clock domain and the peripheral clock domains, some registers need to be synchronized when written or read.

The following bits are synchronized when written:

- Software Reset and Enable bits in Control A register (CTRLA.SWRST and CTRLA.ENABLE)

The following registers are synchronized when written:

- Control B Clear and Control B Set registers (CTRLBCLR and CTRLBSET)
- Status register (STATUS)
- Pattern and Pattern Buffer registers (PATT and PATTBUF)
- Waveform register (WAVE)
- Count Value register (COUNT)
- Period Value and Period Buffer Value registers (PER and PERBUF)
- Compare/Capture Channel x and Channel x Compare/Capture Buffer Value registers (CCx and CCBUFx)

The following registers are synchronized when read:

- Control B Clear and Control B Set registers (CTRLBCLR and CTRLBSET)
- Count Value register (COUNT): synchronization is done on demand through READSYNC command (CTRLBSET.CMD)
- Pattern and Pattern Buffer registers (PATT and PATTBUF)
- Waveform register (WAVE)
- Period Value and Period Buffer Value registers (PER and PERBUF)
- Compare/Capture Channel x and Channel x Compare/Capture Buffer Value registers (CCx and CCBUFx)

Required write-synchronization is denoted by the "Write-Synchronized" property in the register description.

Required read-synchronization is denoted by the "Read-Synchronized" property in the register description.

#### **Related Links**

[Register Synchronization](#)

[Register Synchronization](#)

## 36.7 Register Summary

Offset	Name	Bit Pos.									
0x00	CTRLA	7:0		RESOLUTION[1:0]					ENABLE	SWRST	
0x01		15:8	MSYNC	ALOCK	PRESCYNC[1:0]		RUNSTDBY	PRESCALER[2:0]			
0x02		23:16									
0x03		31:24					CPTEN3	CPTEN2	CPTEN1	CPTEN0	
0x04	CTRLBCLR	7:0		CMD[2:0]		IDXCMD[1:0]	ONESHOT	LUPD	DIR		
0x05	CTRLBSET	7:0		CMD[2:0]		IDXCMD[1:0]	ONESHOT	LUPD	DIR		
0x06 ... 0x07	Reserved										
0x08	SYNCBUSY	7:0	PER	WAVE	PATT	COUNT	STATUS	CTRLB	ENABLE	SWRST	
0x09		15:8					CC3	CC2	CC1	CC0	
0x0A		23:16									
0x0B		31:24									
0x0C	FCTRLA	7:0	RESTART	BLANK[1:0]		QUAL	KEEP		SRC[1:0]		
0x0D		15:8		CAPTURE[2:0]			CHSEL[1:0]		HALT[1:0]		
0x0E		23:16	BLANKVAL[7:0]								
0x0F		31:24	FILTERVAL[3:0]								
0x10	FCTRLB	7:0	RESTART	BLANK[1:0]		QUAL	KEEP		SRC[1:0]		
0x11		15:8		CAPTURE[2:0]			CHSEL[1:0]		HALT[1:0]		
0x12		23:16	BLANKVAL[7:0]								
0x13		31:24	FILTERVAL[3:0]								
0x14	WEXCTRL	7:0							OTMX[1:0]		
0x15		15:8					DTIENx	DTIENx	DTIENx	DTIENx	
0x16		23:16	DTLS[7:0]								
0x17		31:24	DTHS[7:0]								
0x18	DRVCTRL	7:0	NREx	NREx	NREx	NREx	NREx	NREx	NREx	NREx	
0x19		15:8	NRVx	NRVx	NRVx	NRVx	NRVx	NRVx	NRVx	NRVx	
0x1A		23:16	INVENx	INVENx	INVENx	INVENx	INVENx	INVENx	INVENx	INVENx	
0x1B		31:24	FILTERVAL1[3:0]				FILTERVAL0[3:0]				
0x1C ... 0x1D	Reserved										
0x1E	DBGCTRL	7:0						FDDBD		DBGRUN	
0x1F	Reserved										
0x20	EVCTRL	7:0	CNTSEL[1:0]		EVACT1[2:0]		EVACT0[2:0]				
0x21		15:8	TCEIx	TCEIx	TCINVx	TCINVx		CNTEO	TRGEO	OVFEO	
0x22		23:16					MCEIx	MCEIx	MCEIx	MCEIx	
0x23		31:24					MCEOx	MCEOx	MCEOx	MCEOx	
0x24	INTENCLR	7:0					ERR	CNT	TRG	OVF	
0x25		15:8	FAULTx	FAULTx	FAULTB	FAULTA	DFS	UFS			
0x26		23:16					MCx	MCx	MCx	MCx	
0x27		31:24									
0x28	INTENSET	7:0					ERR	CNT	TRG	OVF	
0x29		15:8	FAULTx	FAULTx	FAULTB	FAULTA	DFS	UFS			

# SAM C20 Family

Offset	Name	Bit Pos.								
0x2A		23:16					MCx	MCx	MCx	MCx
0x2B		31:24								
0x2C	INTFLAG	7:0					ERR	CNT	TRG	OVF
0x2D		15:8	FAULTx	FAULTx	FAULTB	FAULTA	DFS	UFS		
0x2E		23:16					MCx	MCx	MCx	MCx
0x2F		31:24								
0x30	STATUS	7:0	PERBUFV	WAVEBUFV	PATTBUFV	SLAVE	DFS	UFS	IDX	STOP
0x31		15:8	FAULTx	FAULTx	FAULTB	FAULTA	FAULT1IN	FAULT0IN	FAULTBIN	FAULTAIN
0x32		23:16					CCBUFVx	CCBUFVx	CCBUFVx	CCBUFVx
0x33		31:24					CMPx	CMPx	CMPx	CMPx
0x34	COUNT	7:0	COUNT[7:0]							
0x35		15:8	COUNT[15:8]							
0x36		23:16	COUNT[23:16]							
0x37		31:24								
0x38	PATT	7:0	PGE0[7:0]							
0x39		15:8	PGV0[7:0]							
0x3A ... 0x3B	Reserved									
0x3C	WAVE	7:0	CIPEREN					WAVEGEN[2:0]		
0x3D		15:8					CICCEN3	CICCEN2	CICCEN1	CICCEN0
0x3E		23:16					POL3	POL2	POL1	POL0
0x3F		31:24					SWAP3	SWAP2	SWAP1	SWAP0
0x40	PER	7:0	PER[1:0]		DITHER[5:0]					
0x41		15:8	PER[9:2]							
0x42		23:16	PER[17:10]							
0x43		31:24								
0x44	CC0	7:0	CC[1:0]		DITHER[5:0]					
0x45		15:8	CC[9:2]							
0x46		23:16	CC[17:10]							
0x47		31:24								
0x48	CC1	7:0	CC[1:0]		DITHER[5:0]					
0x49		15:8	CC[9:2]							
0x4A		23:16	CC[17:10]							
0x4B		31:24								
0x4C	CC2	7:0	CC[1:0]		DITHER[5:0]					
0x4D		15:8	CC[9:2]							
0x4E		23:16	CC[17:10]							
0x4F		31:24								
0x50	CC3	7:0	CC[1:0]		DITHER[5:0]					
0x51		15:8	CC[9:2]							
0x52		23:16	CC[17:10]							
0x53		31:24								
0x54 ... 0x63	Reserved									
0x64	PATTBUF	7:0	PGEB0[7:0]							

Offset	Name	Bit Pos.								
0x65		15:8	PGVB0[7:0]							
0x66	Reserved									
...										
0x67										
0x68	WAVEBUF	7:0	CIPERENB	RAMPB[1:0]			WAVEGENB[2:0]			
0x69		15:8				CICCENB3	CICCENB2	CICCENB1	CICCENB0	
0x6A		23:16				POLB3	POLB2	POLB1	POLB0	
0x6B		31:24				SWAPB 3	SWAPB 2	SWAPB 1	SWAPB 0	
0x6C	PERBUF	7:0	PERBUF[1:0]		DITHERBUF[5:0]					
0x6D		15:8	PERBUF[9:2]							
0x6E		23:16	PERBUF[17:10]							
0x6F		31:24								
0x70	CCBUF0	7:0	CCBUF[1:0]		DITHERBUF[5:0]					
0x71		15:8	CCBUF[9:2]							
0x72		23:16	CCBUF[17:10]							
0x73		31:24								
0x74	CCBUF1	7:0	CCBUF[1:0]		DITHERBUF[5:0]					
0x75		15:8	CCBUF[9:2]							
0x76		23:16	CCBUF[17:10]							
0x77		31:24								
0x78	CCBUF2	7:0	CCBUF[1:0]		DITHERBUF[5:0]					
0x79		15:8	CCBUF[9:2]							
0x7A		23:16	CCBUF[17:10]							
0x7B		31:24								
0x7C	CCBUF3	7:0	CCBUF[1:0]		DITHERBUF[5:0]					
0x7D		15:8	CCBUF[9:2]							
0x7E		23:16	CCBUF[17:10]							
0x7F		31:24								

## 36.8 Register Description

Registers can be 8, 16, or 32 bits wide. Atomic 8-, 16-, and 32-bit accesses are supported. In addition, the 8-bit quarters and 16-bit halves of a 32-bit register, and the 8-bit halves of a 16-bit register can be accessed directly.

Some registers require synchronization when read and/or written. Synchronization is denoted by the "Read-Synchronized" and/or "Write-Synchronized" property in each individual register description.

Optional write-protection by the Peripheral Access Controller (PAC) is denoted by the "PAC Write-Protection" property in each individual register description.

Some registers are enable-protected, meaning they can only be written when the module is disabled. Enable-protection is denoted by the "Enable-Protected" property in each individual register description.

### 36.8.1 Control A

**Name:** CTRLA

**Offset:** 0x00 [ID-00002e48]

**Reset:** 0x00000000

**Property:** PAC Write-Protection, Enable-Protected, Write-Synchronized (ENABLE, SWRST)

Bit	31	30	29	28	27	26	25	24
					CPTEN3	CPTEN2	CPTEN1	CPTEN0
Access					R/W	R/W	R/W	R/W
Reset					0	0	0	0
Bit	23	22	21	20	19	18	17	16
Access								
Reset								
Bit	15	14	13	12	11	10	9	8
	MSYNC	ALOCK	PRESCYNC[1:0]		RUNSTDBY	PRESCALER[2:0]		
Access	R/W	R/W	R/W	R/W	R/W	R/W	R/W	R/W
Reset	0	0	0	0	0	0	0	0
Bit	7	6	5	4	3	2	1	0
			RESOLUTION[1:0]				ENABLE	SWRST
Access			R/W	R/W			R/W	R/W
Reset			0	0			0	0

**Bits 24, 25, 26, 27 – CPTEN0, CPTEN1, CPTEN2, CPTEN3: Capture Channel x Enable**

These bits are used to select the capture or compare operation on channel x.

Writing a '1' to CPTENx enables capture on channel x.

Writing a '0' to CPTENx disables capture on channel x.

**Bit 15 – MSYNC: Master Synchronization (only for TCC slave instance)**

This bit must be set if the TCC counting operation must be synchronized on its Master TCC.

This bit is not synchronized.

Value	Description
0	The TCC controls its own counter.
1	The counter is controlled by its Master TCC.

**Bit 14 – ALOCK: Auto Lock**

This bit is not synchronized.

Value	Description
0	The Lock Update bit in the Control B register (CTRLB.LUPD) is not affected by overflow/underflow, and re-trigger events
1	CTRLB.LUPD is set to '1' on each overflow/underflow or re-trigger event.



### Bits 13:12 – PRESCYNC[1:0]: Prescaler and Counter Synchronization

These bits select if on re-trigger event, the Counter is cleared or reloaded on either the next GCLK\_TCCx clock, or on the next prescaled GCLK\_TCCx clock. It is also possible to reset the prescaler on re-trigger event.

These bits are not synchronized.

Value	Name	Description	
		Counter Reloaded	Prescaler
0x0	GCLK	Reload or reset Counter on next GCLK	-
0x1	PRESC	Reload or reset Counter on next prescaler clock	-
0x2	RESYNC	Reload or reset Counter on next GCLK	Reset prescaler counter
0x3	Reserved		

### Bit 11 – RUNSTDBY: Run in Standby

This bit is used to keep the TCC running in standby mode.

This bit is not synchronized.

Value	Description
0	The TCC is halted in standby.
1	The TCC continues to run in standby.

### Bits 10:8 – PRESCALER[2:0]: Prescaler

These bits select the Counter prescaler factor.

These bits are not synchronized.

Value	Name	Description
0x0	DIV1	Prescaler: GCLK_TCC
0x1	DIV2	Prescaler: GCLK_TCC/2
0x2	DIV4	Prescaler: GCLK_TCC/4
0x3	DIV8	Prescaler: GCLK_TCC/8
0x4	DIV16	Prescaler: GCLK_TCC/16
0x5	DIV64	Prescaler: GCLK_TCC/64
0x6	DIV256	Prescaler: GCLK_TCC/256
0x7	DIV1024	Prescaler: GCLK_TCC/1024

### Bits 6:5 – RESOLUTION[1:0]: Dithering Resolution

These bits increase the TCC resolution by enabling the dithering options.

These bits are not synchronized.

**Table 36-7. Dithering**

Value	Name	Description
0x0	NONE	The dithering is disabled.
0x1	DITH4	Dithering is done every 16 PWM frames. PER[3:0] and CCx[3:0] contain dithering pattern selection.
0x2	DITH5	Dithering is done every 32 PWM frames. PER[4:0] and CCx[4:0] contain dithering pattern selection.
0x3	DITH6	Dithering is done every 64 PWM frames. PER[5:0] and CCx[5:0] contain dithering pattern selection.

**Bit 1 – ENABLE: Enable**

Due to synchronization there is delay from writing CTRLA.ENABLE until the peripheral is enabled/disabled. The value written to CTRLA.ENABLE will read back immediately and the ENABLE bit in the SYNCBUSY register (SYNCBUSY.ENABLE) will be set. SYNCBUSY.ENABLE will be cleared when the operation is complete.

Value	Description
0	The peripheral is disabled.
1	The peripheral is enabled.

**Bit 0 – SWRST: Software Reset**

Writing a '0' to this bit has no effect.

Writing a '1' to this bit resets all registers in the TCC (except DBGCTRL) to their initial state, and the TCC will be disabled.

Writing a '1' to CTRLA.SWRST will always take precedence; all other writes in the same write-operation will be discarded.

Due to synchronization there is a delay from writing CTRLA.SWRST until the reset is complete. CTRLA.SWRST and SYNCBUSY.SWRST will both be cleared when the reset is complete.

Value	Description
0	There is no reset operation ongoing.
1	The reset operation is ongoing.

**36.8.2 Control B Clear**

This register allows the user to change this register without doing a read-modify-write operation. Changes in this register will also be reflected in the Control B Set (CTRLBSET) register.

**Name:** CTRLBCLR  
**Offset:** 0x04 [ID-00002e48]  
**Reset:** 0x00  
**Property:** PAC Write-Protection, Write-Synchronized, Read-Synchronized

Bit	7	6	5	4	3	2	1	0
	CMD[2:0]			IDXCMD[1:0]		ONESHOT	LUPD	DIR
Access	R/W	R/W	R/W	R/W	R/W	R/W	R/W	R/W
Reset	0	0	0	0	0	0	0	0

### Bits 7:5 – CMD[2:0]: TCC Command

These bits can be used for software control of re-triggering and stop commands of the TCC. When a command has been executed, the CMD bit field will read back zero. The commands are executed on the next prescaled GCLK\_TCC clock cycle.

Writing zero to this bit group has no effect.

Writing a '1' to any of these bits will clear the pending command.

Value	Name	Description
0x0	NONE	No action
0x1	RETRIGGER	Clear start, restart or retrigger
0x2	STOP	Force stop
0x3	UPDATE	Force update of double buffered registers
0x4	READSYNC	Force COUNT read synchronization

### Bits 4:3 – IDXCMD[1:0]: Ramp Index Command

These bits can be used to force cycle A and cycle B changes in RAMP2 and RAMP2A operation. On timer/counter update condition, the command is executed, the IDX flag in STATUS register is updated and the IDXCMD command is cleared.

Writing zero to these bits has no effect.

Writing a '1' to any of these bits will clear the pending command.

Value	Name	Description
0x0	DISABLE	DISABLE Command disabled: IDX toggles between cycles A and B
0x1	SET	Set IDX: cycle B will be forced in the next cycle
0x2	CLEAR	Clear IDX: cycle A will be forced in next cycle
0x3	HOLD	Hold IDX: the next cycle will be the same as the current cycle.

### Bit 2 – ONESHOT: One-Shot

This bit controls one-shot operation of the TCC. When one-shot operation is enabled, the TCC will stop counting on the next overflow/underflow condition or on a stop command.

Writing a '0' to this bit has no effect

Writing a '1' to this bit will disable the one-shot operation.

Value	Description
0	The TCC will update the counter value on overflow/underflow condition and continue operation.
1	The TCC will stop counting on the next underflow/overflow condition.

## Bit 1 – LUPD: Lock Update

This bit controls the update operation of the TCC buffered registers.

When CTRLB.LUPD is set, no any update of the registers with value of its buffered register is performed on hardware UPDATE condition. Locking the update ensures that all buffer registers are valid before an hardware update is performed. After all the buffer registers are loaded correctly, the buffered registers can be unlocked.

This bit has no effect when input capture operation is enabled.

Writing a '0' to this bit has no effect.

Writing a '1' to this bit will enable updating.

Value	Description
0	The CCBx, PERB, PGVB, PGOB, and SWAPBx buffer registers values <i>are</i> copied into the corresponding CCx, PER, PGV, PGO and SWAPx registers on hardware update condition.
1	The CCBx, PERB, PGVB, PGOB, and SWAPBx buffer registers values are <i>not</i> copied into the corresponding CCx, PER, PGV, PGO and SWAPx registers on hardware update condition.

## Bit 0 – DIR: Counter Direction

This bit is used to change the direction of the counter.

Writing a '0' to this bit has no effect

Writing a '1' to this bit will clear the bit and make the counter count up.

Value	Description
0	The timer/counter is counting up (incrementing).
1	The timer/counter is counting down (decrementing).

### 36.8.3 Control B Set

This register allows the user to change this register without doing a read-modify-write operation. Changes in this register will also be reflected in the Control B Set (CTRLBCLR) register.

**Name:** CTRLBSET

**Offset:** 0x05 [ID-00002e48]

**Reset:** 0x00

**Property:** PAC Write-Protection, Write-Synchronized, Read-Synchronized

Bit	7	6	5	4	3	2	1	0
	CMD[2:0]			IDXCMD[1:0]		ONESHOT	LUPD	DIR
Access	R/W	R/W	R/W	R/W	R/W	R/W	R/W	R/W
Reset	0	0	0	0	0	0	0	0

#### Bits 7:5 – CMD[2:0]: TCC Command

These bits can be used for software control of re-triggering and stop commands of the TCC. When a command has been executed, the CMD bit field will be read back as zero. The commands are executed on the next prescaled GCLK\_TCC clock cycle.

Writing zero to this bit group has no effect

Writing a valid value to this bit group will set the associated command.

Value	Name	Description
0x0	NONE	No action
0x1	RETRIGGER	Force start, restart or retrigger
0x2	STOP	Force stop
0x3	UPDATE	Force update of double buffered registers
0x4	READSYNC	Force a read synchronization of COUNT

### Bits 4:3 – IDXCMD[1:0]: Ramp Index Command

These bits can be used to force cycle A and cycle B changes in RAMP2 and RAMP2A operation. On timer/counter update condition, the command is executed, the IDX flag in STATUS register is updated and the IDXCMD command is cleared.

Writing a zero to these bits has no effect.

Writing a valid value to these bits will set a command.

Value	Name	Description
0x0	DISABLE	Command disabled: IDX toggles between cycles A and B
0x1	SET	Set IDX: cycle B will be forced in the next cycle
0x2	CLEAR	Clear IDX: cycle A will be forced in next cycle
0x3	HOLD	Hold IDX: the next cycle will be the same as the current cycle.

### Bit 2 – ONESHOT: One-Shot

This bit controls one-shot operation of the TCC. When in one-shot operation, the TCC will stop counting on the next overflow/underflow condition or a stop command.

Writing a '0' to this bit has no effect.

Writing a '1' to this bit will enable the one-shot operation.

Value	Description
0	The TCC will count continuously.
1	The TCC will stop counting on the next underflow/overflow condition.

### Bit 1 – LUPD: Lock Update

This bit controls the update operation of the TCC buffered registers.

When CTRLB.LUPD is set, no any update of the registers with value of its buffered register is performed on hardware UPDATE condition. Locking the update ensures that all buffer registers are valid before an hardware update is performed. After all the buffer registers are loaded correctly, the buffered registers can be unlocked.

This bit has no effect when input capture operation is enabled.

Writing a '0' to this bit has no effect.

Writing a '1' to this bit will lock updating.

Value	Description
0	The CCBx, PERB, PGVB, PGOB, and SWAPBx buffer registers values <i>are</i> copied into the corresponding CCx, PER, PGV, PGO and SWAPx registers on hardware update condition.
1	The CCBx, PERB, PGVB, PGOB, and SWAPBx buffer registers values are <i>not</i> copied into CCx, PER, PGV, PGO and SWAPx registers on hardware update condition.

### Bit 0 – DIR: Counter Direction

This bit is used to change the direction of the counter.

Writing a '0' to this bit has no effect

Writing a '1' to this bit will clear the bit and make the counter count up.

Value	Description
0	The timer/counter is counting up (incrementing).
1	The timer/counter is counting down (decrementing).

### 36.8.4 Synchronization Busy

**Name:** SYNCBUSY  
**Offset:** 0x08 [ID-00002e48]  
**Reset:** 0x00000000  
**Property:** -

	Bit	31	30	29	28	27	26	25	24
Access									
Reset									
	Bit	23	22	21	20	19	18	17	16
Access									
Reset									
	Bit	15	14	13	12	11	10	9	8
						CC3	CC2	CC1	CC0
Access						R	R	R	R
Reset						0	0	0	0
	Bit	7	6	5	4	3	2	1	0
		PER	WAVE	PATT	COUNT	STATUS	CTRLB	ENABLE	SWRST
Access		R	R	R	R	R	R	R	R
Reset		0	0	0	0	0	0	0	0

**Bits 8, 9, 10, 11 – CC: Compare/Capture Channel x Synchronization Busy**

This bit is cleared when the synchronization of Compare/Capture Channel x register between the clock domains is complete.

This bit is set when the synchronization of Compare/Capture Channel x register between clock domains is started.

CCx bit is available only for existing Compare/Capture Channels. For details on CC channels number, refer to each TCC feature list.

This bit is set when the synchronization of CCx register between clock domains is started.

**Bit 7 – PER: PER Synchronization Busy**

This bit is cleared when the synchronization of PER register between the clock domains is complete.

This bit is set when the synchronization of PER register between clock domains is started.

**Bit 6 – WAVE: WAVE Synchronization Busy**

This bit is cleared when the synchronization of WAVE register between the clock domains is complete.

This bit is set when the synchronization of WAVE register between clock domains is started.

**Bit 5 – PATT: PATT Synchronization Busy**

This bit is cleared when the synchronization of PATTERN register between the clock domains is complete.

This bit is set when the synchronization of PATTERN register between clock domains is started.

**Bit 4 – COUNT: COUNT Synchronization Busy**

This bit is cleared when the synchronization of COUNT register between the clock domains is complete.

This bit is set when the synchronization of COUNT register between clock domains is started.

**Bit 3 – STATUS: STATUS Synchronization Busy**

This bit is cleared when the synchronization of STATUS register between the clock domains is complete.

This bit is set when the synchronization of STATUS register between clock domains is started.

**Bit 2 – CTRLB: CTRLB Synchronization Busy**

This bit is cleared when the synchronization of CTRLB register between the clock domains is complete.

This bit is set when the synchronization of CTRLB register between clock domains is started.

**Bit 1 – ENABLE: ENABLE Synchronization Busy**

This bit is cleared when the synchronization of ENABLE bit between the clock domains is complete.

This bit is set when the synchronization of ENABLE bit between clock domains is started.

**Bit 0 – SWRST: SWRST Synchronization Busy**

This bit is cleared when the synchronization of SWRST bit between the clock domains is complete.

This bit is set when the synchronization of SWRST bit between clock domains is started.

## 36.8.5 Fault Control A and B

**Name:** FCTRLA, FCTRLB

**Offset:** 0x0C + n\*0x04 [n=0..1]

**Reset:** 0x00000000

**Property:** PAC Write-Protection, Enable-Protected

Bit	31	30	29	28	27	26	25	24
	FILTERVAL[3:0]							
Access					R/W	R/W	R/W	R/W
Reset					0	0	0	0
Bit	23	22	21	20	19	18	17	16
	BLANKVAL[7:0]							
Access	R/W	R/W	R/W	R/W	R/W	R/W	R/W	R/W
Reset	0	0	0	0	0	0	0	0
Bit	15	14	13	12	11	10	9	8
		CAPTURE[2:0]			CHSEL[1:0]		HALT[1:0]	
Access		R/W	R/W	R/W	R/W	R/W	R/W	R/W
Reset		0	0	0	0	0	0	0
Bit	7	6	5	4	3	2	1	0
	RESTART	BLANK[1:0]		QUAL	KEEP		SRC[1:0]	
Access	R/W	R/W	R/W	R/W	R/W		R/W	R/W
Reset	0	0	0	0	0		0	0

**Bits 27:24 – FILTERVAL[3:0]: Recoverable Fault n Filter Value**

These bits define the filter value applied on MCEx (x=0,1) event input line. The value must be set to zero when MCEx event is used as synchronous event.

**Bits 23:16 – BLANKVAL[7:0]: Recoverable Fault n Blanking Value**

These bits determine the duration of the blanking of the fault input source. Activation and edge selection of the blank filtering are done by the BLANK bits (FCTRLn.BLANK).

When enabled, the fault input source is internally disabled for BLANKVAL\* prescaled GCLK\_TCC periods after the detection of the waveform edge.

**Bits 14:12 – CAPTURE[2:0]: Recoverable Fault n Capture Action**

These bits select the capture and Fault n interrupt/event conditions.

**Table 36-8. Fault n Capture Action**

Value	Name	Description
0x0	DISABLE	Capture on valid recoverable Fault n is disabled
0x1	CAPT	On rising edge of a valid recoverable Fault n, capture counter value on channel selected by CHSEL[1:0].  INTFLAG.FAULTn flag rises on each new captured value.
0x2	CAPTMIN	On rising edge of a valid recoverable Fault n, capture counter value on channel selected by CHSEL[1:0], if COUNT value is lower than the last stored capture value (CC).  INTFLAG.FAULTn flag rises on each local minimum detection.
0x3	CAPTMAX	On rising edge of a valid recoverable Fault n, capture counter value on channel selected by CHSEL[1:0], if COUNT value is higher than the last stored capture value (CC).



Value	Name	Description
		INTFLAG.FAULTn flag rises on each local maximum detection.
0x4	LOCMIN	On rising edge of a valid recoverable Fault n, capture counter value on channel selected by CHSEL[1:0].  INTFLAG.FAULTn flag rises on each local minimum value detection.
0x5	LOCMAX	On rising edge of a valid recoverable Fault n, capture counter value on channel selected by CHSEL[1:0].  INTFLAG.FAULTn flag rises on each local maximum detection.
0x6	DERIV0	On rising edge of a valid recoverable Fault n, capture counter value on channel selected by CHSEL[1:0].  INTFLAG.FAULTn flag rises on each local maximum or minimum detection.

### Bits 11:10 – CHSEL[1:0]: Recoverable Fault n Capture Channel

These bits select the channel for capture operation triggered by recoverable Fault n.

Value	Name	Description
0x0	CC0	Capture value stored into CC0
0x1	CC1	Capture value stored into CC1
0x2	CC2	Capture value stored into CC2
0x3	CC3	Capture value stored into CC3

### Bits 9:8 – HALT[1:0]: Recoverable Fault n Halt Operation

These bits select the halt action for recoverable Fault n.

Value	Name	Description
0x0	DISABLE	Halt action disabled
0x1	HW	Hardware halt action
0x2	SW	Software halt action
0x3	NR	Non-recoverable fault

### Bit 7 – RESTART: Recoverable Fault n Restart

Setting this bit enables restart action for Fault n.

Value	Description
0	Fault n restart action is disabled.
1	Fault n restart action is enabled.

### Bits 6:5 – BLANK[1:0]: Recoverable Fault n Blanking Operation

These bits, select the blanking start point for recoverable Fault n.

Value	Name	Description
0x0	START	Blanking applied from start of the Ramp period
0x1	RISE	Blanking applied from rising edge of the waveform output
0x2	FALL	Blanking applied from falling edge of the waveform output
0x3	BOTH	Blanking applied from each toggle of the waveform output

### Bit 4 – QUAL: Recoverable Fault n Qualification

Setting this bit enables the recoverable Fault n input qualification.

Value	Description
0	The recoverable Fault n input is not disabled on CMPx value condition.
1	The recoverable Fault n input is disabled when output signal is at inactive level (CMPx == 0).

### Bit 3 – KEEP: Recoverable Fault n Keep

Setting this bit enables the Fault n keep action.

Value	Description
0	The Fault n state is released as soon as the recoverable Fault n is released.
1	The Fault n state is released at the end of TCC cycle.

### Bits 1:0 – SRC[1:0]: Recoverable Fault n Source

These bits select the TCC event input for recoverable Fault n.

Event system channel connected to MCEx event input, must be configured to route the event asynchronously, when used as a recoverable Fault n input.

Value	Name	Description
0x0	DISABLE	Fault input disabled
0x1	ENABLE	MCEx (x=0,1) event input
0x2	INVERT	Inverted MCEx (x=0,1) event input
0x3	ALTFAULT	Alternate fault (A or B) state at the end of the previous period.

## 36.8.6 Waveform Extension Control

**Name:** WEXCTRL

**Offset:** 0x14 [ID-00002e48]

**Reset:** 0x00000000

**Property:** PAC Write-Protection, Enable-Protected

Bit	31	30	29	28	27	26	25	24
	DTHS[7:0]							
Access	R/W	R/W	R/W	R/W	R/W	R/W	R/W	R/W
Reset	0	0	0	0	0	0	0	0
Bit	23	22	21	20	19	18	17	16
	DTLS[7:0]							
Access	R/W	R/W	R/W	R/W	R/W	R/W	R/W	R/W
Reset	0	0	0	0	0	0	0	0
Bit	15	14	13	12	11	10	9	8
					DTIENx	DTIENx	DTIENx	DTIENx
Access					R/W	R/W	R/W	R/W
Reset					0	0	0	0
Bit	7	6	5	4	3	2	1	0
							OTMX[1:0]	
Access							R/W	R/W
Reset							0	0

**Bits 31:24 – DTHS[7:0]: Dead-Time High Side Outputs Value**

This register holds the number of GCLK\_TCC clock cycles for the dead-time high side.

**Bits 23:16 – DTLS[7:0]: Dead-time Low Side Outputs Value**

This register holds the number of GCLK\_TCC clock cycles for the dead-time low side.

**Bits 11,10,9,8 – DTIENx : Dead-time Insertion Generator x Enable**

Setting any of these bits enables the dead-time insertion generator for the corresponding output matrix. This will override the output matrix [x] and [x+WO\_NUM/2], with the low side and high side waveform respectively.

Value	Description
0	No dead-time insertion override.
1	Dead time insertion override on signal outputs[x] and [x+WO_NUM/2], from matrix outputs[x] signal.

**Bits 1:0 – OTMX[1:0]: Output Matrix**

These bits define the matrix routing of the TCC waveform generation outputs to the port pins, according to [Table 36-4](#).

## 36.8.7 Driver Control

**Name:** DRVCTRL

**Offset:** 0x18 [ID-00002e48]

**Reset:** 0x00000000

**Property:** PAC Write-Protection, Enable-Protected

Bit	31	30	29	28	27	26	25	24
	FILTERVAL1[3:0]				FILTERVAL0[3:0]			
Access	R/W	R/W	R/W	R/W	R/W	R/W	R/W	R/W
Reset	0	0	0	0	0	0	0	0
Bit	23	22	21	20	19	18	17	16
	INVENx	INVENx	INVENx	INVENx	INVENx	INVENx	INVENx	INVENx
Access	R/W	R/W	R/W	R/W	R/W	R/W	R/W	R/W
Reset	0	0	0	0	0	0	0	0
Bit	15	14	13	12	11	10	9	8
	NRVx	NRVx	NRVx	NRVx	NRVx	NRVx	NRVx	NRVx
Access	R/W	R/W	R/W	R/W	R/W	R/W	R/W	R/W
Reset	0	0	0	0	0	0	0	0
Bit	7	6	5	4	3	2	1	0
	NREx	NREx	NREx	NREx	NREx	NREx	NREx	NREx
Access	R/W	R/W	R/W	R/W	R/W	R/W	R/W	R/W
Reset	0	0	0	0	0	0	0	0

**Bits 31:28 – FILTERVAL1[3:0]: Non-Recoverable Fault Input 1 Filter Value**

These bits define the filter value applied on TCE1 event input line. When the TCE1 event input line is configured as a synchronous event, this value must be 0x0.

**Bits 27:24 – FILTERVAL0[3:0]: Non-Recoverable Fault Input 0 Filter Value**

These bits define the filter value applied on TCE0 event input line. When the TCE0 event input line is configured as a synchronous event, this value must be 0x0.

**Bits 23,22,21,20,19,18,17,16 – INVENx: Waveform Output x Inversion**

These bits are used to select inversion on the output of channel x.

Writing a '1' to INVENx inverts output from WO[x].

Writing a '0' to INVENx disables inversion of output from WO[x].

**Bits 15,14,13,12,11,10,9,8 – NRVx: NRVx Non-Recoverable State x Output Value**

These bits define the value of the enabled override outputs, under non-recoverable fault condition.

**Bits 7,6,5,4,3,2,1,0 – NREx: Non-Recoverable State x Output Enable**

These bits enable the override of individual outputs by NRVx value, under non-recoverable fault condition.

Value	Description
0	Non-recoverable fault tri-state the output.
1	Non-recoverable faults set the output to NRVx level.

### 36.8.8 Debug control

**Name:** DBGCTRL  
**Offset:** 0x1E [ID-00002e48]  
**Reset:** 0x00  
**Property:** PAC Write-Protection

	7	6	5	4	3	2	1	0
						FDDBD		DBGRUN
Access						R/W		R/W
Reset						0		0

### Bit 2 – FDDBD: Fault Detection on Debug Break Detection

This bit is not affected by software reset and should not be changed by software while the TCC is enabled.

By default this bit is zero, and the on-chip debug (OCD) fault protection is disabled. When this bit is written to '1', OCD break request from the OCD system will trigger non-recoverable fault. When this bit is set, OCD fault protection is enabled and OCD break request from the OCD system will trigger a non-recoverable fault.

Value	Description
0	No faults are generated when TCC is halted in debug mode.
1	A non recoverable fault is generated and FAULTD flag is set when TCC is halted in debug mode.

### Bit 0 – DBGRUN: Debug Running State

This bit is not affected by software reset and should not be changed by software while the TCC is enabled.

Value	Description
0	The TCC is halted when the device is halted in debug mode.
1	The TCC continues normal operation when the device is halted in debug mode.

## 36.8.9 Event Control

**Name:** EVCTRL  
**Offset:** 0x20 [ID-00002e48]  
**Reset:** 0x00000000  
**Property:** PAC Write-Protection, Enable-Protected

Bit	31	30	29	28	27	26	25	24
					MCEOx	MCEOx	MCEOx	MCEOx
Access					R/W	R/W	R/W	R/W
Reset					0	0	0	0
Bit	23	22	21	20	19	18	17	16
					MCEIx	MCEIx	MCEIx	MCEIx
Access					R/W	R/W	R/W	R/W
Reset					0	0	0	0
Bit	15	14	13	12	11	10	9	8
	TCEIx	TCEIx	TCINVx	TCINVx		CNTEO	TRGEO	OVFEO
Access	R/W	R/W	R/W	R/W		R/W	R/W	R/W
Reset	0	0	0	0		0	0	0
Bit	7	6	5	4	3	2	1	0
	CNTSEL[1:0]		EVACT1[2:0]			EVACT0[2:0]		
Access	R/W	R/W	R/W	R/W	R/W	R/W	R/W	R/W
Reset	0	0	0	0	0	0	0	0

**Bits 27,26,25,24 – MCEOx: Match or Capture Channel x Event Output Enable**

These bits control if the Match/capture event on channel x is enabled and will be generated for every match or capture.

Value	Description
0	Match/capture x event is disabled and will not be generated.
1	Match/capture x event is enabled and will be generated for every compare/capture on channel x.

**Bits 19,18,17,16 – MCEIx: Match or Capture Channel x Event Input Enable**

These bits indicate if the Match/capture x incoming event is enabled

These bits are used to enable match or capture input events to the CCx channel of TCC.

Value	Description
0	Incoming events are disabled.
1	Incoming events are enabled.

**Bits 15,14 – TCEIx: Timer/Counter Event Input x Enable**

This bit is used to enable input event x to the TCC.

Value	Description
0	Incoming event x is disabled.
1	Incoming event x is enabled.

**Bits 13,12 – TCINVx: Timer/Counter Event x Invert Enable**

This bit inverts the event x input.

Value	Description
0	Input event source x is not inverted.
1	Input event source x is inverted.

## Bit 10 – CNTEO: Timer/Counter Event Output Enable

This bit is used to enable the counter cycle event. When enabled, an event will be generated on begin or end of counter cycle depending of CNTSEL[1:0] settings.

Value	Description
0	Counter cycle output event is disabled and will not be generated.
1	Counter cycle output event is enabled and will be generated depend of CNTSEL[1:0] value.

## Bit 9 – TRGEO: Retrigger Event Output Enable

This bit is used to enable the counter retrigger event. When enabled, an event will be generated when the counter retriggers operation.

Value	Description
0	Counter retrigger event is disabled and will not be generated.
1	Counter retrigger event is enabled and will be generated for every counter retrigger.

## Bit 8 – OVFE0: Overflow/Underflow Event Output Enable

This bit is used to enable the overflow/underflow event. When enabled an event will be generated when the counter reaches the TOP or the ZERO value.

Value	Description
0	Overflow/underflow counter event is disabled and will not be generated.
1	Overflow/underflow counter event is enabled and will be generated for every counter overflow/underflow.

## Bits 7:6 – CNTSEL[1:0]: Timer/Counter Interrupt and Event Output Selection

These bits define on which part of the counter cycle the counter event output is generated.

Value	Name	Description
0x0	BEGIN	An interrupt/event is generated at begin of each counter cycle
0x1	END	An interrupt/event is generated at end of each counter cycle
0x2	BETWEEN	An interrupt/event is generated between each counter cycle.
0x3	BOUNDARY	An interrupt/event is generated at begin of first counter cycle, and end of last counter cycle.

## Bits 5:3 – EVACT1[2:0]: Timer/Counter Event Input 1 Action

These bits define the action the TCC will perform on TCE1 event input.

Value	Name	Description
0x0	OFF	Event action disabled.
0x1	RETRIGGER	Start restart or re-trigger TC on event
0x2	DIR (asynch)	Direction control
0x3	STOP	Stop TC on event
0x4	DEC	Decrement TC on event
0x5	PPW	Period captured into CC0 Pulse Width on CC1
0x6	PWP	Period captured into CC1 Pulse Width on CC0
0x7	FAULT	Non-recoverable Fault

## Bits 2:0 – EVACT0[2:0]: Timer/Counter Event Input 0 Action

These bits define the action the TCC will perform on TCE0 event input 0.

Value	Name	Description
0x0	OFF	Event action disabled.
0x1	RETRIGGER	Start restart or re-trigger TC on event
0x2	COUNTEV	Count on event.
0x3	START	Start TC on event
0x4	INC	Increment TC on EVENT
0x5	COUNT (async)	Count on active state of asynchronous event
0x6		
0x7	FAULT	Non-recoverable Fault

### 36.8.10 Interrupt Enable Clear

This register allows the user to enable an interrupt without doing a read-modify-write operation. Changes in this register will also be reflected in the Interrupt Enable Set (INTENSET) register.

**Name:** INTENCLR

**Offset:** 0x24 [ID-00002e48]

**Reset:** 0x00000000

**Property:** PAC Write-Protection

Bit	31	30	29	28	27	26	25	24
Access								
Reset								
Bit	23	22	21	20	19	18	17	16
Access					MCx	MCx	MCx	MCx
Reset					0	0	0	0
Bit	15	14	13	12	11	10	9	8
Access	FAULTx	FAULTx	FAULTB	FAULTA	DFS	UFS		
Reset	0	0	0	0	0	0		
Bit	7	6	5	4	3	2	1	0
Access					ERR	CNT	TRG	OVF
Reset					0	0	0	0

#### Bits 19,18,17,16 – MCx: Match or Capture Channel x Interrupt Enable

Writing a '0' to this bit has no effect.

Writing a '1' to this bit will clear the corresponding Match or Capture Channel x Interrupt Disable/Enable bit, which disables the Match or Capture Channel x interrupt.

Value	Description
0	The Match or Capture Channel x interrupt is disabled.
1	The Match or Capture Channel x interrupt is enabled.



## Bits 15,14 – FAULTx: Non-Recoverable Fault x Interrupt Enable

Writing a '0' to this bit has no effect.

Writing a '1' to this bit will clear the Non-Recoverable Fault x Interrupt Disable/Enable bit, which disables the Non-Recoverable Fault x interrupt.

Value	Description
0	The Non-Recoverable Fault x interrupt is disabled.
1	The Non-Recoverable Fault x interrupt is enabled.

## Bit 13 – FAULTB: Recoverable Fault B Interrupt Enable

Writing a '0' to this bit has no effect.

Writing a '1' to this bit will clear the Recoverable Fault B Interrupt Disable/Enable bit, which disables the Recoverable Fault B interrupt.

Value	Description
0	The Recoverable Fault B interrupt is disabled.
1	The Recoverable Fault B interrupt is enabled.

## Bit 12 – FAULTA: Recoverable Fault A Interrupt Enable

Writing a '0' to this bit has no effect.

Writing a '1' to this bit will clear the Recoverable Fault A Interrupt Disable/Enable bit, which disables the Recoverable Fault A interrupt.

Value	Description
0	The Recoverable Fault A interrupt is disabled.
1	The Recoverable Fault A interrupt is enabled.

## Bit 11 – DFS: Non-Recoverable Debug Fault Interrupt Enable

Writing a '0' to this bit has no effect.

Writing a '1' to this bit will clear the Debug Fault State Interrupt Disable/Enable bit, which disables the Debug Fault State interrupt.

Value	Description
0	The Debug Fault State interrupt is disabled.
1	The Debug Fault State interrupt is enabled.

## Bit 10 – UFS: Non-Recoverable Update Fault Interrupt Enable

Writing a zero to this bit has no effect.

Writing a one to this bit will clear the Non-Recoverable Update Fault Interrupt Disable/Enable bit, which disables the Non-Recoverable Update Fault interrupt.

Value	Description
0	The Non-Recoverable Update Fault interrupt is disabled.
1	The Non-Recoverable Update Fault interrupt is enabled.

## Bit 3 – ERR: Error Interrupt Enable

Writing a '0' to this bit has no effect.

Writing a '1' to this bit will clear the Error Interrupt Disable/Enable bit, which disables the Compare interrupt.

Value	Description
0	The Error interrupt is disabled.
1	The Error interrupt is enabled.

### Bit 2 – CNT: Counter Interrupt Enable

Writing a '0' to this bit has no effect.

Writing a '1' to this bit will clear the Counter Interrupt Disable/Enable bit, which disables the Counter interrupt.

Value	Description
0	The Counter interrupt is disabled.
1	The Counter interrupt is enabled.

### Bit 1 – TRG: Retrigger Interrupt Enable

Writing a '0' to this bit has no effect.

Writing a '1' to this bit will clear the Retrigger Interrupt Disable/Enable bit, which disables the Retrigger interrupt.

Value	Description
0	The Retrigger interrupt is disabled.
1	The Retrigger interrupt is enabled.

### Bit 0 – OVF: Overflow Interrupt Enable

Writing a '0' to this bit has no effect.

Writing a '1' to this bit will clear the Overflow Interrupt Disable/Enable bit, which disables the Overflow interrupt request.

Value	Description
0	The Overflow interrupt is disabled.
1	The Overflow interrupt is enabled.

## 36.8.11 Interrupt Enable Set

This register allows the user to enable an interrupt without doing a read-modify-write operation. Changes in this register will also be reflected in the Interrupt Enable Clear (INTENCLR) register.

**Name:** INTENSET

**Offset:** 0x28 [ID-00002e48]

**Reset:** 0x00000000

**Property:** PAC Write-Protection

Bit	31	30	29	28	27	26	25	24
Access								
Reset								
Bit	23	22	21	20	19	18	17	16
					MCx	MCx	MCx	MCx
Access					R/W	R/W	R/W	R/W
Reset					0	0	0	0
Bit	15	14	13	12	11	10	9	8
	FAULTx	FAULTx	FAULTB	FAULTA	DFS	UFS		
Access	R/W	R/W	R/W	R/W	R/W	R/W		
Reset	0	0	0	0	0	0		
Bit	7	6	5	4	3	2	1	0
					ERR	CNT	TRG	OVF
Access					R/W	R/W	R/W	R/W
Reset					0	0	0	0

**Bits 19,18,17,16 – MCx: Match or Capture Channel x Interrupt Enable**

Writing a '0' to this bit has no effect.

Writing a '1' to this bit will set the corresponding Match or Capture Channel x Interrupt Disable/Enable bit, which enables the Match or Capture Channel x interrupt.

Value	Description
0	The Match or Capture Channel x interrupt is disabled.
1	The Match or Capture Channel x interrupt is enabled.

**Bits 15,14 – FAULTx: Non-Recoverable Fault x Interrupt Enable**

Writing a '0' to this bit has no effect.

Writing a '1' to this bit will set the Non-Recoverable Fault x Interrupt Disable/Enable bit, which enables the Non-Recoverable Fault x interrupt.

Value	Description
0	The Non-Recoverable Fault x interrupt is disabled.
1	The Non-Recoverable Fault x interrupt is enabled.

**Bit 13 – FAULTB: Recoverable Fault B Interrupt Enable**

Writing a '0' to this bit has no effect.

Writing a '1' to this bit will set the Recoverable Fault B Interrupt Disable/Enable bit, which enables the Recoverable Fault B interrupt.

Value	Description
0	The Recoverable Fault B interrupt is disabled.
1	The Recoverable Fault B interrupt is enabled.

**Bit 12 – FAULTA: Recoverable Fault A Interrupt Enable**

Writing a '0' to this bit has no effect.

Writing a '1' to this bit will set the Recoverable Fault A Interrupt Disable/Enable bit, which enables the Recoverable Fault A interrupt.

Value	Description
0	The Recoverable Fault A interrupt is disabled.
1	The Recoverable Fault A interrupt is enabled.

### Bit 11 – DFS: Non-Recoverable Debug Fault Interrupt Enable

Writing a '0' to this bit has no effect.

Writing a '1' to this bit will set the Debug Fault State Interrupt Disable/Enable bit, which enables the Debug Fault State interrupt.

Value	Description
0	The Debug Fault State interrupt is disabled.
1	The Debug Fault State interrupt is enabled.

### Bit 10 – UFS: Non-Recoverable Update Fault Interrupt Enable

Writing a zero to this bit has no effect.

Writing a one to this bit will set the Non-Recoverable Update Fault Interrupt Disable/Enable bit, which enables the Non-Recoverable Update Fault interrupt.

Value	Description
0	The Non-Recoverable Update Fault interrupt is disabled.
1	The Non-Recoverable Update Fault interrupt is enabled.

### Bit 3 – ERR: Error Interrupt Enable

Writing a '0' to this bit has no effect.

Writing a '1' to this bit will set the Error Interrupt Disable/Enable bit, which enables the Compare interrupt.

Value	Description
0	The Error interrupt is disabled.
1	The Error interrupt is enabled.

### Bit 2 – CNT: Counter Interrupt Enable

Writing a '0' to this bit has no effect.

Writing a '1' to this bit will set the Retrigger Interrupt Disable/Enable bit, which enables the Counter interrupt.

Value	Description
0	The Counter interrupt is disabled.
1	The Counter interrupt is enabled.

### Bit 1 – TRG: Retrigger Interrupt Enable

Writing a '0' to this bit has no effect.

Writing a '1' to this bit will set the Retrigger Interrupt Disable/Enable bit, which enables the Retrigger interrupt.

Value	Description
0	The Retrigger interrupt is disabled.
1	The Retrigger interrupt is enabled.

## Bit 0 – OVF: Overflow Interrupt Enable

Writing a '0' to this bit has no effect.

Writing a '1' to this bit will set the Overflow Interrupt Disable/Enable bit, which enables the Overflow interrupt request.

Value	Description
0	The Overflow interrupt is disabled.
1	The Overflow interrupt is enabled.

### 36.8.12 Interrupt Flag Status and Clear

**Name:** INTFLAG

**Offset:** 0x2C [ID-00002e48]

**Reset:** 0x00000000

**Property:** -

Bit	31	30	29	28	27	26	25	24
Access								
Reset								
Bit	23	22	21	20	19	18	17	16
Access					MCx	MCx	MCx	MCx
Reset					0	0	0	0
Bit	15	14	13	12	11	10	9	8
Access	FAULTx	FAULTx	FAULTB	FAULTA	DFS	UFS		
Reset	0	0	0	0	0	0		
Bit	7	6	5	4	3	2	1	0
Access					ERR	CNT	TRG	OVF
Reset					0	0	0	0

#### Bits 19,18,17,16 – MCx: Match or Capture Channel x Interrupt Flag

This flag is set on the next CLK\_TCC\_COUNT cycle after a match with the compare condition or once CCx register contain a valid capture value.

Writing a '0' to one of these bits has no effect.

Writing a '1' to one of these bits will clear the corresponding Match or Capture Channel x interrupt flag

In Capture operation, this flag is automatically cleared when CCx register is read.

#### Bits 15,14 – FAULTx: Non-Recoverable Fault x Interrupt Flag

This flag is set on the next CLK\_TCC\_COUNT cycle after a Non-Recoverable Fault x occurs.

Writing a '0' to this bit has no effect.

Writing a '1' to this bit clears the Non-Recoverable Fault x interrupt flag.

**Bit 13 – FAULTB: Recoverable Fault B Interrupt Flag**

This flag is set on the next CLK\_TCC\_COUNT cycle after a Recoverable Fault B occurs.

Writing a '0' to this bit has no effect.

Writing a '1' to this bit clears the Recoverable Fault B interrupt flag.

**Bit 12 – FAULTA: Recoverable Fault A Interrupt Flag**

This flag is set on the next CLK\_TCC\_COUNT cycle after a Recoverable Fault A occurs.

Writing a '0' to this bit has no effect.

Writing a '1' to this bit clears the Recoverable Fault A interrupt flag.

**Bit 11 – DFS: Non-Recoverable Debug Fault State Interrupt Flag**

This flag is set on the next CLK\_TCC\_COUNT cycle after an Debug Fault State occurs.

Writing a '0' to this bit has no effect.

Writing a '1' to this bit clears the Debug Fault State interrupt flag.

**Bit 10 – UFS: Non-Recoverable Update Fault**

This flag is set when the RAMP index changes and the Lock Update bit is set (CTRLBSET.LUPD).

Writing a zero to this bit has no effect.

Writing a one to this bit clears the Non-Recoverable Update Fault interrupt flag.

**Bit 3 – ERR: Error Interrupt Flag**

This flag is set if a new capture occurs on a channel when the corresponding Match or Capture Channel x interrupt flag is one. In which case there is nowhere to store the new capture.

Writing a '0' to this bit has no effect.

Writing a '1' to this bit clears the error interrupt flag.

**Bit 2 – CNT: Counter Interrupt Flag**

This flag is set on the next CLK\_TCC\_COUNT cycle after a counter event occurs.

Writing a '0' to this bit has no effect.

Writing a '1' to this bit clears the CNT interrupt flag.

**Bit 1 – TRG: Retrigger Interrupt Flag**

This flag is set on the next CLK\_TCC\_COUNT cycle after a counter retrigger occurs.

Writing a '0' to this bit has no effect.

Writing a '1' to this bit clears the re-trigger interrupt flag.

**Bit 0 – OVF: Overflow Interrupt Flag**

This flag is set on the next CLK\_TCC\_COUNT cycle after an overflow condition occurs.

Writing a '0' to this bit has no effect.

Writing a '1' to this bit clears the Overflow interrupt flag.

## 36.8.13 Status

**Name:** STATUS  
**Offset:** 0x30 [ID-00002e48]  
**Reset:** 0x00000001  
**Property:** -

Bit	31	30	29	28	27	26	25	24
					CMPx	CMPx	CMPx	CMPx
Access					R	R	R	R
Reset					0	0	0	0
Bit	23	22	21	20	19	18	17	16
					CCBUFVx	CCBUFVx	CCBUFVx	CCBUFVx
Access					R/W	R/W	R/W	R/W
Reset					0	0	0	0
Bit	15	14	13	12	11	10	9	8
	FAULTx	FAULTx	FAULTB	FAULTA	FAULT1IN	FAULT0IN	FAULTBIN	FAULTAIN
Access	R/W	R/W	R/W	R/W	R	R	R	R
Reset	0	0	0	0	0	0	0	0
Bit	7	6	5	4	3	2	1	0
	PERBUFV	WAVEBUFV	PATTBUFV	SLAVE	DFS	UFS	IDX	STOP
Access	R/W	R/W	R/W	R	R/W	R/W	R	R
Reset	0	0	0	0	0	0	0	1

**Bits 27,26,25,24 – CMPx: Channel x Compare Value**

This bit reflects the channel x output compare value.

Value	Description
0	Channel compare output value is 0.
1	Channel compare output value is 1.

**Bits 19,18,17,16 – CCBUFVx: Channel x Compare or Capture Buffer Valid**

For a compare channel, this bit is set when a new value is written to the corresponding CCBUFx register. The bit is cleared either by writing a '1' to the corresponding location when CTRLB.LUPD is set, or automatically on an UPDATE condition.

For a capture channel, the bit is set when a valid capture value is stored in the CCBUFx register. The bit is automatically cleared when the CCx register is read.

**Bits 15,14 – FAULTx: Non-recoverable Fault x State**

This bit is set by hardware as soon as non-recoverable Fault x condition occurs.

This bit is cleared by writing a one to this bit and when the corresponding FAULTxIN status bit is low.

Once this bit is clear, the timer/counter will restart from the last COUNT value. To restart the timer/counter from BOTTOM, the timer/counter restart command must be executed before clearing the corresponding STATEx bit. For further details on timer/counter commands, refer to available commands description ([CTRLBSET.CMD](#)).

**Bit 13 – FAULTB: Recoverable Fault B State**

This bit is set by hardware as soon as recoverable Fault B condition occurs.

This bit can be clear by hardware when Fault B action is resumed, or by writing a '1' to this bit when the corresponding FAULTBIN bit is low. If software halt command is enabled (FAULTB.HALT=SW), clearing this bit will release the timer/counter.

## **Bit 12 – FAULTA: Recoverable Fault A State**

This bit is set by hardware as soon as recoverable Fault A condition occurs.

This bit can be clear by hardware when Fault A action is resumed, or by writing a '1' to this bit when the corresponding FAULTAIN bit is low. If software halt command is enabled (FAULTA.HALT=SW), clearing this bit will release the timer/counter.

## **Bit 11 – FAULT1IN: Non-Recoverable Fault 1 Input**

This bit is set while an active Non-Recoverable Fault 1 input is present.

## **Bit 10 – FAULT0IN: Non-Recoverable Fault 0 Input**

This bit is set while an active Non-Recoverable Fault 0 input is present.

## **Bit 9 – FAULTBIN: Recoverable Fault B Input**

This bit is set while an active Recoverable Fault B input is present.

## **Bit 8 – FAULTAIN: Recoverable Fault A Input**

This bit is set while an active Recoverable Fault A input is present.

## **Bit 7 – PERBUFV: Period Buffer Valid**

This bit is set when a new value is written to the PERBUF register. This bit is automatically cleared by hardware on UPDATE condition when CTRLB.LUPD is set, or by writing a '1' to this bit.

## **Bit 6 – WAVEBUFV: Waveform Control Buffer Valid**

This bit is set when a new value is written to the WAVEBUF register. This bit is automatically cleared by hardware on UPDATE condition when CTRLB.LUPD is set, or by writing a '1' to this bit.

## **Bit 5 – PATTBUFV: Pattern Generator Value Buffer Valid**

This bit is set when a new value is written to the PATTBUF register. This bit is automatically cleared by hardware on UPDATE condition when CTRLB.LUPD is set, or by writing a '1' to this bit.

## **Bit 4 – SLAVE: Slave**

This bit is set when TCC is set in Slave mode. This bit follows the CTRLA.MSYNC bit state.

## **Bit 3 – DFS: Debug Fault State**

This bit is set by hardware in debug mode when DDBGCTRL.FDDBD bit is set. The bit is cleared by writing a '1' to this bit and when the TCC is not in debug mode.

When the bit is set, the counter is halted and the waveforms state depend on DRVCTRL.NRE and DRVCTRL.NRV registers.

## **Bit 2 – UFS: Non-recoverable Update Fault State**

This bit is set by hardware when the RAMP index changes and the Lock Update bit is set (CTRLBSET.LUPD). The bit is cleared by writing a one to this bit.

When the bit is set, the waveforms state depend on DRVCTRL.NRE and DRVCTRL.NRV registers.



## Bit 1 – IDX: Ramp Index

In RAMP2 and RAMP2A operation, the bit is cleared during the cycle A and set during the cycle B. In RAMP1 operation, the bit always reads zero. For details on ramp operations, refer to [Ramp Operations](#).

## Bit 0 – STOP: Stop

This bit is set when the TCC is disabled either on a STOP command or on an UPDATE condition when One-Shot operation mode is enabled (CTRLBSET.ONESHOT=1).

This bit is clear on the next incoming counter increment or decrement.

Value	Description
0	Counter is running.
1	Counter is stopped.

### 36.8.14 Counter Value

**Note:** Prior to any read access, this register must be synchronized by user by writing the according TCC Command value to the Control B Set register (CTRLBSET.CMD=READSYNC).

**Name:** COUNT

**Offset:** 0x34 [ID-00002e48]

**Reset:** 0x00000000

**Property:** PAC Write-Protection, Write-Synchronized, Read-Synchronized

Bit	31	30	29	28	27	26	25	24
Access								
Reset								
Bit	23	22	21	20	19	18	17	16
	COUNT[23:16]							
Access	R/W	R/W	R/W	R/W	R/W	R/W	R/W	R/W
Reset	0	0	0	0	0	0	0	0
Bit	15	14	13	12	11	10	9	8
	COUNT[15:8]							
Access	R/W	R/W	R/W	R/W	R/W	R/W	R/W	R/W
Reset	0	0	0	0	0	0	0	0
Bit	7	6	5	4	3	2	1	0
	COUNT[7:0]							
Access	R/W	R/W	R/W	R/W	R/W	R/W	R/W	R/W
Reset	0	0	0	0	0	0	0	0

### Bits 23:0 – COUNT[23:0]: Counter Value

These bits hold the value of the counter register.

**Note:** When the TCC is configured as 16-bit timer/counter, the excess bits are read zero.

**Note:** This bit field occupies the MSB of the register, [23:m]. m is dependent on the Resolution bit in the Control A register (CTRLA.RESOLUTION):

CTRLA.RESOLUTION	Bits [23:m]
0x0 - NONE	23:0 (depicted)
0x1 - DITH4	23:4
0x2 - DITH5	23:5
0x3 - DITH6	23:6

### 36.8.15 Pattern

**Name:** PATT  
**Offset:** 0x38 [ID-00002e48]  
**Reset:** 0x0000  
**Property:** Write-Synchronized

	Bit	15	14	13	12	11	10	9	8
		PGV0[7:0]							
Access		R/W	R/W	R/W	R/W	R/W	R/W	R/W	R/W
Reset		0	0	0	0	0	0	0	0
	Bit	7	6	5	4	3	2	1	0
		PGE0[7:0]							
Access		R/W	R/W	R/W	R/W	R/W	R/W	R/W	R/W
Reset		0	0	0	0	0	0	0	0

**Bits 8:15, 16:23, 24:31, 32:39, 40:47, 48:55, 56:63, 64:71 – PGV: Pattern Generation Output Value**  
 This register holds the values of pattern for each waveform output.

**Bits 0:7, 8:15, 16:23, 24:31, 32:39, 40:47, 48:55, 56:63 – PGE: Pattern Generation Output Enable**  
 This register holds the enable status of pattern generation for each waveform output. A bit written to '1' will override the corresponding SWAP output with the corresponding PGVn value.

### 36.8.16 Waveform

**Name:** WAVE  
**Offset:** 0x3C [ID-00002e48]  
**Reset:** 0x00000000  
**Property:** Write-Synchronized

Bit	31	30	29	28	27	26	25	24
					SWAP3	SWAP2	SWAP1	SWAP0
Access					R/W	R/W	R/W	R/W
Reset					0	0	0	0
Bit	23	22	21	20	19	18	17	16
					POL3	POL2	POL1	POL0
Access					R/W	R/W	R/W	R/W
Reset					0	0	0	0
Bit	15	14	13	12	11	10	9	8
					CICCEN3	CICCEN2	CICCEN1	CICCEN0
Access					R/W	R/W	R/W	R/W
Reset					0	0	0	0
Bit	7	6	5	4	3	2	1	0
	CIPEREN							WAVEGEN[2:0]
Access	R/W							R/W
Reset	0							0

**Bits 24, 25, 26, 27 – SWAP: Swap DTI Output Pair x**

Setting these bits enables output swap of DTI outputs [x] and [x+WO\_NUM/2]. Note the DTIxEN settings will not affect the swap operation.

**Bits 16, 17, 18, 19 – POL: Channel Polarity x**

Setting these bits enables the output polarity in single-slope and dual-slope PWM operations.

Value	Name	Description
0	(single-slope PWM waveform generation)	Compare output is initialized to ~DIR and set to DIR when TCC counter matches CCx value
1	(single-slope PWM waveform generation)	Compare output is initialized to DIR and set to ~DIR when TCC counter matches CCx value.
0	(dual-slope PWM waveform generation)	Compare output is set to ~DIR when TCC counter matches CCx value
1	(dual-slope PWM waveform generation)	Compare output is set to DIR when TCC counter matches CCx value.

**Bits 8, 9, 10, 11 – CICCEN: Circular CC Enable x**

Setting this bits enables the compare circular buffer option on channel. When the bit is set, CCx register value is copied-back into the CCx register on UPDATE condition.

**Bit 7 – CIPEREN: Circular Period Enable**

Setting this bits enable the period circular buffer option. When the bit is set, the PER register value is copied-back into the PERB register on UPDATE condition.

These bits select Ramp operation (RAMP). These bits are not synchronized.

Value	Name	Description
0x0	RAMP1	RAMP1 operation
0x1	RAMP2A	Alternative RAMP2 operation
0x2	RAMP2	RAMP2 operation

Value	Name	Description
0x3	RAMP2C	Critical RAMP2 operation
0x4		

### Bits 2:0 – WAVEGEN[2:0]: Waveform Generation Operation

These bits select the waveform generation operation. The settings impact the top value and control if frequency or PWM waveform generation should be used. These bits are not synchronized.

Value	Name	Description						
		Operation	Top	Update	Waveform Output On Match	Waveform Output On Update	OVFIF/Event Up Down	
0x0	NFRQ	Normal Frequency	PER	TOP/Zero	Toggle	Stable	TOP	Zero
0x1	MFRQ	Match Frequency	CC0	TOP/Zero	Toggle	Stable	TOP	Zero
0x2	NPWM	Normal PWM	PER	TOP/Zero	Set	Clear	TOP	Zero
0x3								
0x4	DSCRITICAL	Dual-slope PWM	PER	Zero	~DIR	Stable	–	Zero
0x5	DSBOTTOM	Dual-slope PWM	PER	Zero	~DIR	Stable	–	Zero
0x6	DSBOTH	Dual-slope PWM	PER	TOP & Zero	~DIR	Stable	TOP	Zero
0x7	DSTOP	Dual-slope PWM	PER	Zero	~DIR	Stable	TOP	–

### 36.8.17 Period Value

**Name:** PER  
**Offset:** 0x40 [ID-00002e48]  
**Reset:** 0xFFFFFFFF  
**Property:** Write-Synchronized

Bit	31	30	29	28	27	26	25	24
Access								
Reset								
Bit	23	22	21	20	19	18	17	16
Access	R/W							
Reset	1							
Bit	15	14	13	12	11	10	9	8
Access	R/W							
Reset	1							
Bit	7	6	5	4	3	2	1	0
Access	R/W		R/W		R/W		R/W	
Reset	1		1		1		1	

### Bits 23:6 – PER[17:0]: Period Value

These bits hold the value of the period buffer register.

**Note:** When the TCC is configured as 16-bit timer/counter, the excess bits are read zero.

**Note:** This bit field occupies the MSB of the register, [23:m]. m is dependent on the Resolution bit in the Control A register (CTRLA.RESOLUTION):

CTRLA.RESOLUTION	Bits [23:m]
0x0 - NONE	23:0
0x1 - DITH4	23:4
0x2 - DITH5	23:5
0x3 - DITH6	23:6 (depicted)

### Bits 5:0 – DITHER[5:0]: Dithering Cycle Number

These bits hold the number of extra cycles that are added on the PWM pulse period every 64 PWM frames.

**Note:** This bit field consists of the n LSB of the register. n is dependent on the value of the Resolution bits in the Control A register (CTRLA.RESOLUTION):

CTRLA.RESOLUTION	Bits [n:0]
0x0 - NONE	-
0x1 - DITH4	3:0
0x2 - DITH5	4:0
0x3 - DITH6	5:0 (depicted)

## 36.8.18 Compare/Capture Channel x

The CCx register represents the 16-, 24- bit value, CCx. The register has two functions, depending of the mode of operation.

For capture operation, this register represents the second buffer level and access point for the CPU and DMA.

For compare operation, this register is continuously compared to the counter value. Normally, the output form the comparator is then used for generating waveforms.

CCx register is updated with the buffer value from their corresponding CCBUFx register when an UPDATE condition occurs.

In addition, in match frequency operation, the CC0 register controls the counter period.

**Name:** CC  
**Offset:** 0x44 + n\*0x04 [n=0..3]  
**Reset:** 0x00000000  
**Property:** Write-Synchronized, Read-Synchronized

Bit	31	30	29	28	27	26	25	24
Access								
Reset								
Bit	23	22	21	20	19	18	17	16
Access	CC[17:10]							
Reset	0							
Bit	15	14	13	12	11	10	9	8
Access	CC[9:2]							
Reset	0							
Bit	7	6	5	4	3	2	1	0
Access	CC[1:0]		DITHER[5:0]					
Reset	0		0					

### Bits 23:6 – CC[17:0]: Channel x Compare/Capture Value

These bits hold the value of the Channel x compare/capture register.

**Note:** When the TCC is configured as 16-bit timer/counter, the excess bits are read zero.

**Note:** This bit field occupies the m MSB of the register, [23:m]. m is dependent on the Resolution bit in the Control A register (CTRLA.RESOLUTION):

CTRLA.RESOLUTION	Bits [23:m]
0x0 - NONE	23:0
0x1 - DITH4	23:4

CTRLA.RESOLUTION	Bits [23:m]
0x2 - DITH5	23:5
0x3 - DITH6	23:6 (depicted)

**Bits 5:0 – DITHER[5:0]: Dithering Cycle Number**

These bits hold the number of extra cycles that are added on the PWM pulse width every 64 PWM frames.

**Note:** This bit field consists of the n LSB of the register. n is dependent on the value of the Resolution bits in the Control A register (CTRLA.RESOLUTION):

CTRLA.RESOLUTION	Bits [n:0]
0x0 - NONE	-
0x1 - DITH4	3:0
0x2 - DITH5	4:0
0x3 - DITH6	5:0 (depicted)

### 36.8.19 Pattern Buffer

**Name:** PATTBUF

**Offset:** 0x64

**Reset:** 0x0000

**Property:** Write-Synchronized, Read-Synchronized

Bit	15	14	13	12	11	10	9	8
	PGVB0[7:0]							
Access	R/W	R/W	R/W	R/W	R/W	R/W	R/W	R/W
Reset	0	0	0	0	0	0	0	0
Bit	7	6	5	4	3	2	1	0
	PGEBO[7:0]							
Access	R/W	R/W	R/W	R/W	R/W	R/W	R/W	R/W
Reset	0	0	0	0	0	0	0	0

**Bits 8:15, 16:23, 24:31, 32:39, 40:47, 48:55, 56:63, 64:71 – PGVB: Pattern Generation Output Value Buffer**

This register is the buffer for the PGV register. If double buffering is used, valid content in this register is copied to the PGV register on an UPDATE condition.

**Bits 0:7, 8:15, 16:23, 24:31, 32:39, 40:47, 48:55, 56:63 – PGEBO: Pattern Generation Output Enable Buffer**

This register is the buffer of the PGE register. If double buffering is used, valid content in this register is copied into the PGE register at an UPDATE condition.

### 36.8.20 Waveform Buffer

**Name:** WAVEBUF  
**Offset:** 0x68 [ID-00002e48]  
**Reset:** 0x00000000  
**Property:** Write-Synchronized, Read-Synchronized

Bit	31	30	29	28	27	26	25	24
					SWAPB 3	SWAPB 2	SWAPB 1	SWAPB 0
Access					R/W	R/W	R/W	R/W
Reset					0	0	0	0
Bit	23	22	21	20	19	18	17	16
					POLB3	POLB2	POLB1	POLB0
Access					R/W	R/W	R/W	R/W
Reset					0	0	0	0
Bit	15	14	13	12	11	10	9	8
					CICCENB3	CICCENB2	CICCENB1	CICCENB0
Access					R/W	R/W	R/W	R/W
Reset					0	0	0	0
Bit	7	6	5	4	3	2	1	0
	CIPERENB		RAMPB[1:0]			WAVEGENB[2:0]		
Access	R/W		R/W	R/W		R/W	R/W	R/W
Reset	0		0	0		0	0	0

**Bits 24, 25, 26, 27 – SWAPB : Swap DTI output pair x Buffer**

These register bits are the buffer bits for the SWAP register bits. If double buffering is used, valid content in these bits is copied to the corresponding SWAPx bits on an UPDATE condition.

**Bits 16, 17, 18, 19 – POLB: Channel Polarity x Buffer**

These register bits are the buffer bits for POLx register bits. If double buffering is used, valid content in these bits is copied to the corresponding POBx bits on an UPDATE condition.

**Bits 8, 9, 10, 11 – CICCENB: Circular CCx Buffer Enable**

These register bits are the buffer bits for CICCENx register bits. If double buffering is used, valid content in these bits is copied to the corresponding CICCENx bits on a UPDATE condition.

**Bit 7 – CIPERENB: Circular Period Enable Buffer**

This register bit is the buffer bit for CIPEREN register bit. If double buffering is used, valid content in this bit is copied to the corresponding CIPEREN bit on a UPDATE condition.

**Bits 5:4 – RAMPB[1:0]: Ramp Operation Buffer**

These register bits are the buffer bits for RAMP register bits. If double buffering is used, valid content in these bits is copied to the corresponding RAMP bits on a UPDATE condition.

**Bits 2:0 – WAVEGENB[2:0]: Waveform Generation Operation Buffer**

These register bits are the buffer bits for WAVEGEN register bits. If double buffering is used, valid content in these bits is copied to the corresponding WAVEGEN bits on a UPDATE condition.

### 36.8.21 Period Buffer Value



**Name:** PERBUF  
**Offset:** 0x6C [ID-00002e48]  
**Reset:** 0xFFFFFFFF  
**Property:** Write-Synchronized, Read-Synchronized

Bit	31	30	29	28	27	26	25	24
Access								
Reset								
Bit	23	22	21	20	19	18	17	16
	PERBUF[17:10]							
Access	R/W	R/W	R/W	R/W	R/W	R/W	R/W	R/W
Reset	1	1	1	1	1	1	1	1
Bit	15	14	13	12	11	10	9	8
	PERBUF[9:2]							
Access	R/W	R/W	R/W	R/W	R/W	R/W	R/W	R/W
Reset	1	1	1	1	1	1	1	1
Bit	7	6	5	4	3	2	1	0
	PERBUF[1:0]		DITHERBUF[5:0]					
Access	R/W	R/W	R/W	R/W	R/W	R/W	R/W	R/W
Reset	1	1	1	1	1	1	1	1

**Bits 23:6 – PERBUF[17:0]: Period Buffer Value**

These bits hold the value of the period buffer register. The value is copied to PER register on UPDATE condition.

**Note:** When the TCC is configured as 16-bit timer/counter, the excess bits are read zero.

**Note:** This bit field occupies the MSB of the register, [23:m]. m is dependent on the Resolution bit in the Control A register (CTRLA.RESOLUTION):

CTRLA.RESOLUTION	Bits [23:m]
0x0 - NONE	23:0
0x1 - DITH4	23:4
0x2 - DITH5	23:5
0x3 - DITH6	23:6 (depicted)

**Bits 5:0 – DITHERBUF[5:0]: Dithering Buffer Cycle Number**

These bits represent the PER.DITHER bits buffer. When the double buffering is enabled, the value of this bit field is copied to the PER.DITHER bits on an UPDATE condition.

**Note:** This bit field consists of the n LSB of the register. n is dependent on the value of the Resolution bits in the Control A register (CTRLA.RESOLUTION):

CTRLA.RESOLUTION	Bits [n:0]
0x0 - NONE	-
0x1 - DITH4	3:0
0x2 - DITH5	4:0
0x3 - DITH6	5:0 (depicted)

### 36.8.22 Channel x Compare/Capture Buffer Value

CCBUF<sub>x</sub> is copied into CC<sub>x</sub> at TCC update time

**Name:** CCBUF

**Offset:** 0x70 + n\*0x04 [n=0..3]

**Reset:** 0x00000000

**Property:** Write-Synchronized, Read-Synchronized

Bit	31	30	29	28	27	26	25	24
Access								
Reset								
Bit	23	22	21	20	19	18	17	16
	CCBUF[17:10]							
Access	R/W	R/W	R/W	R/W	R/W	R/W	R/W	R/W
Reset	0	0	0	0	0	0	0	0
Bit	15	14	13	12	11	10	9	8
	CCBUF[9:2]							
Access	R/W	R/W	R/W	R/W	R/W	R/W	R/W	R/W
Reset	0	0	0	0	0	0	0	0
Bit	7	6	5	4	3	2	1	0
	CCBUF[1:0]		DITHERBUF[5:0]					
Access	R/W	R/W	R/W	R/W	R/W	R/W	R/W	R/W
Reset	0	0	0	0	0	0	0	0

#### Bits 23:6 – CCBUF[17:0]: Channel x Compare/Capture Buffer Value

These bits hold the value of the Channel x Compare/Capture Buffer Value register. The register serves as the buffer for the associated compare or capture registers (CC<sub>x</sub>). Accessing this register using the CPU or DMA will affect the corresponding CCBUF<sub>v</sub><sub>x</sub> status bit.

**Note:** When the TCC is configured as 16-bit timer/counter, the excess bits are read zero.

**Note:** This bit field occupies the MSB of the register, [23:m]. m is dependent on the Resolution bit in the Control A register (CTRLA.RESOLUTION):

CTRLA.RESOLUTION	Bits [23:m]
0x0 - NONE	23:0
0x1 - DITH4	23:4

CTRLA.RESOLUTION	Bits [23:m]
0x2 - DITH5	23:5
0x3 - DITH6	23:6 (depicted)

**Bits 5:0 – DITHERBUF[5:0]: Dithering Buffer Cycle Number**

These bits represent the CCx.DITHER bits buffer. When the double buffering is enable, DITHERBUF bits value is copied to the CCx.DITHER bits on an UPDATE condition.

**Note:** This bit field consists of the n LSB of the register. n is dependent on the value of the Resolution bits in the Control A register (CTRLA.RESOLUTION):

CTRLA.RESOLUTION	Bits [n:0]
0x0 - NONE	-
0x1 - DITH4	3:0
0x2 - DITH5	4:0
0x3 - DITH6	5:0 (depicted)

## 37. CCL – Configurable Custom Logic

### 37.1 Overview

The Configurable Custom Logic (CCL) is a programmable logic peripheral which can be connected to the device pins, to events, or to other internal peripherals. This allows the user to eliminate logic gates for simple glue logic functions on the PCB.

Each LookUp Table (LUT) consists of three inputs, a truth table, and as options synchronizer, filter and edge detector. Each LUT can generate an output as a user programmable logic expression with three inputs. Inputs can be individually masked.

The output can be combinatorially generated from the inputs, and can be filtered to remove spikes. Optional sequential logic can be used. The inputs of the sequential module are individually controlled by two independent, adjacent LUT (LUT0/LUT1, LUT2/LUT3 etc.) outputs, enabling complex waveform generation.

### 37.2 Features

- Glue logic for general purpose PCB design
- Up to 4 programmable LookUp Tables (LUTs)
- Combinatorial logic functions:  
AND, NAND, OR, NOR, XOR, XNOR, NOT
- Sequential logic functions:  
Gated D Flip-Flop, JK Flip-Flop, gated D Latch, RS Latch
- Flexible LUT inputs selection:
  - I/Os
  - Events
  - Internal peripherals
  - Subsequent LUT output
- Output can be connected to the I/O pins or the Event System
- Optional synchronizer, filter, or edge detector available on each LUT output

### 37.3 Block Diagram

Figure 37-1. Configurable Custom Logic



### 37.4 Signal Description

Pin Name	Type	Description
OUT[n:0]	Digital output	Output from lookup table
IN[3n+2:0]	Digital input	Input to lookup table

- n is the number of CCL groups.

Refer to *I/O Multiplexing and Considerations* for details on the pin mapping for this peripheral. One signal can be mapped on several pins.

#### Related Links

[I/O Multiplexing and Considerations](#)

### 37.5 Product Dependencies

In order to use this peripheral, other parts of the system must be configured correctly, as described below.

#### 37.5.1 I/O Lines

Using the CCL I/O lines requires the I/O pins to be configured. Refer to *PORT - I/O Pin Configuration* for details.

#### Related Links

[PORT: IO Pin Controller](#)

#### 37.5.2 Power Management

This peripheral can continue to operate in any sleep mode where its source clock is running. Events connected to the event system can trigger other operations in the system without exiting sleep modes.

## Related Links

[PM – Power Manager](#)

### 37.5.3 Clocks

The CCL bus clock (CLK\_CCL\_APB) can be enabled and disabled in the power manager, and the default state of CLK\_CCL\_APB can be found in the *Peripheral Clock Masking*.

A generic clock (GCLK\_CCL) is optionally required to clock the CCL. This clock must be configured and enabled in the Generic Clock Controller (GCLK) before using input events, filter, edge detection or sequential logic. GCLK\_CCL is required when input events, a filter, an edge detector, or a sequential submodule is enabled. Refer to *GCLK - Generic Clock Controller* for details.

This generic clock is asynchronous to the user interface clock (CLK\_CCL\_APB).

## Related Links

[Peripheral Clock Masking](#)

[GCLK - Generic Clock Controller](#)

### 37.5.4 DMA

Not applicable.

### 37.5.5 Interrupts

Not applicable.

### 37.5.6 Events

The events are connected to the Event System. Refer to *EVSYS – Event System* for details on how to configure the Event System.

## Related Links

[EVSYS – Event System](#)

### 37.5.7 Debug Operation

When the CPU is halted in debug mode the CCL continues normal operation. If the CCL is configured in a way that requires it to be periodically serviced by the CPU, improper operation or data loss may result during debugging.

### 37.5.8 Register Access Protection

All registers with write-access can be write-protected optionally by the peripheral access controller (PAC). Refer to *PAC - Peripheral Access Controller* for details.

Optional write-protection by the Peripheral Access Controller (PAC) is denoted by the "PAC Write-Protection" property in each individual register description.

PAC write-protection does not apply to accesses through an external debugger.

## Related Links

[PAC - Peripheral Access Controller](#)

### 37.5.9 Analog Connections

Not applicable.

## 37.6 Functional Description

### 37.6.1 Principle of Operation

Configurable Custom Logic (CCL) is a programmable logic block that can use the device port pins, internal peripherals, and the internal Event System as both input and output channels. The CCL can serve as glue logic between the device and external devices. The CCL can eliminate the need for external logic component and can also help the designer overcome challenging real-time constraints by combining core independent peripherals in clever ways to handle the most time critical parts of the application independent of the CPU.

### 37.6.2 Operation

#### 37.6.2.1 Initialization

The following bits are enable-protected, meaning that they can only be written when the corresponding even LUT is disabled (LUTCTRLx.ENABLE=0):

- Sequential Selection bits in the Sequential Control x (SEQCTRLx.SEQSEL) register

The following registers are enable-protected, meaning that they can only be written when the corresponding LUT is disabled (LUTCTRLx.ENABLE=0):

- LUT Control x (LUTCTRLx) register, except the ENABLE bit

Enable-protected bits in the LUTCTRLx registers can be written at the same time as LUTCTRLx.ENABLE is written to '1', but not at the same time as LUTCTRLx.ENABLE is written to '0'.

Enable-protection is denoted by the Enable-Protected property in the register description.

#### 37.6.2.2 Enabling, Disabling, and Resetting

The CCL is enabled by writing a '1' to the Enable bit in the Control register (CTRL.ENABLE). The CCL is disabled by writing a '0' to CTRL.ENABLE.

Each LUT is enabled by writing a '1' to the Enable bit in the LUT Control x register (LUTCTRLx.ENABLE). Each LUT is disabled by writing a '0' to LUTCTRLx.ENABLE.

The CCL is reset by writing a '1' to the Software Reset bit in the Control register (CTRL.SWRST). All registers in the CCL will be reset to their initial state, and the CCL will be disabled. Refer to CTRL for details.

#### 37.6.2.3 Lookup Table Logic

The lookup table in each LUT unit can generate any logic expression OUT as a function of three inputs (IN[2:0]), as shown in Figure 37-2. One or more inputs can be masked. The truth table for the expression is defined by TRUTH bits in LUT Control x register (LUTCTRLx.TRUTH).

**Figure 37-2. Truth Table Output Value Selection**



Table 37-1. Truth Table of LUT

IN[2]	IN[1]	IN[0]	OUT
0	0	0	TRUTH[0]
0	0	1	TRUTH[1]
0	1	0	TRUTH[2]
0	1	1	TRUTH[3]
1	0	0	TRUTH[4]
1	0	1	TRUTH[5]
1	1	0	TRUTH[6]
1	1	1	TRUTH[7]

37.6.2.4 Truth Table Inputs Selection

Input Overview

The inputs can be individually:

- Masked
- Driven by peripherals:
  - Analog comparator output (AC)
  - Timer/Counters waveform outputs (TC)
  - Serial Communication output transmit interface (SERCOM)
- Driven by internal events from Event System
- Driven by other CCL sub-modules

The Input Selection for each input y of LUT x is configured by writing the Input y Source Selection bit in the LUT x Control register (LUTCTRLx.INSELY).

Masked Inputs (MASK)

When a LUT input is masked (LUTCTRLx.INSELY=MASK), the corresponding TRUTH input (IN) is internally tied to zero, as shown in this figure:

Figure 37-3. Masked Input Selection



Internal Feedback Inputs (FEEDBACK)

When selected (LUTCTRLx.INSELY=FEEDBACK), the Sequential (SEQ) output is used as input for the corresponding LUT.

The output from an internal sequential sub-module can be used as input source for the LUT, see figure below for an example for LUT0 and LUT1. The sequential selection for each LUT follows the formula:



$$IN[2N][i] = SEQ[N]$$

$$IN[2N+1][i] = SEQ[N]$$

With  $N$  representing the sequencer number and  $i=0,1,2$  representing the LUT input index.

For details, refer to [Sequential Logic](#).

**Figure 37-4. Feedback Input Selection**



**Linked LUT (LINK)**

When selected ( $LUTCTRLx.INSELY=LINK$ ), the subsequent LUT output is used as the LUT input (e.g., LUT2 is the input for LUT1), as shown in this figure:

**Figure 37-5. Linked LUT Input Selection**

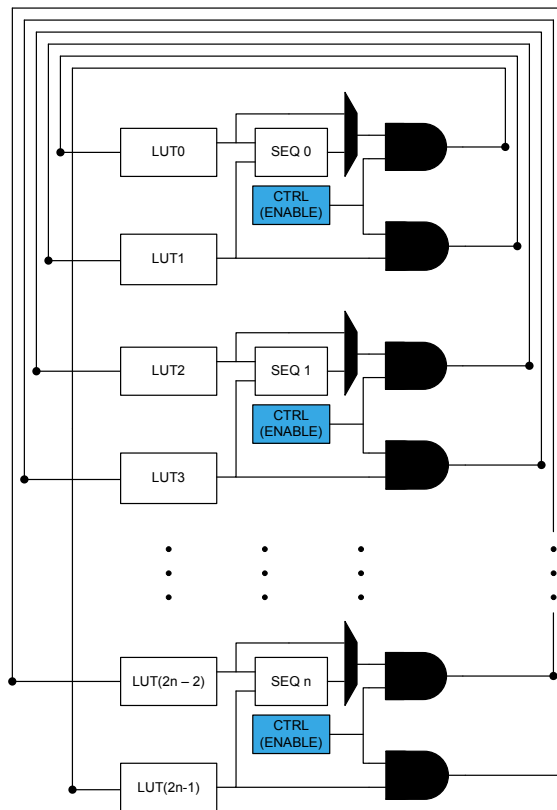

## Internal Events Inputs Selection (EVENT)

Asynchronous events from the Event System can be used as input selection, as shown in [Figure 37-6](#). For each LUT, one event input line is available and can be selected on each LUT input. Before enabling the event selection by writing `LUTCTRLx.INSELY=EVENT`, the Event System must be configured first.

By default CCL includes an edge detector. When the event is received, an internal strobe is generated when a rising edge is detected. The pulse duration is one `GCLK_CCL` clock cycle. Writing the `LUTCTRLx.INSELY=ASYNCEVENT` will disable the edge detector. In this case, it is possible to combine an asynchronous event input with any other input source. This is typically useful with event levels inputs (external IO pin events, as example). The following steps ensure proper operation:

1. Enable the `GCLK_CCL` clock.
2. Configure the Event System to route the event asynchronously.
3. Select the event input type (`LUTCTRLx.INSEL`).
4. If a strobe must be generated on the event input falling edge, write a '1' to the Inverted Event Input Enable bit in LUT Control register (`LUTCTRLx.INVEI`).
5. Enable the event input by writing the Event Input Enable bit in LUT Control register (`LUTCTRLx.LUTEI`) to '1'.

**Figure 37-6. Event Input Selection**



## I/O Pin Inputs (IO)

When the IO pin is selected as LUT input (`LUTCTRLx.INSELY=IO`), the corresponding LUT input will be connected to the pin, as shown in the figure below.

**Figure 37-7. I/O Pin Input Selection**



## Analog Comparator Inputs (AC)

The AC outputs can be used as input source for the LUT (`LUTCTRLx.INSELY=AC`).

The analog comparator outputs are distributed following the formula:

$$IN[N][i]=AC[N \% \text{ComparatorOutput\_Number}]$$

With  $N$  representing the LUT number and  $i=[0,1,2]$  representing the LUT input index.

Before selecting the comparator output, the AC must be configured first.

The output of comparator 0 is available on even LUTs ("LUT(2x)": LUT0, LUT2) and the comparator 1 output is available on odd LUTs ("LUT(2x+1)": LUT1, LUT3), as shown in the figure below.

**Figure 37-8. AC Input Selection**



### Timer/Counter Inputs (TC)

The TC waveform output WO[0] can be used as input source for the LUT (LUTCTRLx.INSELY=TC). Only consecutive instances of the TC, i.e. TCx and the subsequent TC(x+1), are available as default and alternative TC selections (e.g., TC0 and TC1 are sources for LUT0, TC1 and TC2 are sources for LUT1, etc). See the figure below for an example for LUT0. More general, the Timer/Counter selection for each LUT follows the formula:

$$IN[N][i] = DefaultTC[N \% TC\_Instance\_Number]$$

$$IN[N][i] = AlternativeTC[(N + 1) \% TC\_Instance\_Number]$$

Where N represents the LUT number and i represents the LUT input index (i=0,1,2).

Before selecting the waveform outputs, the TC must be configured first.

**Figure 37-9. TC Input Selection**

### Timer/Counter for Control Application Inputs (TCC)

The TCC waveform outputs can be used as input source for the LUT. Only WO[2:0] outputs can be selected and routed to the respective LUT input (i.e., IN0 is connected to WO0, IN1 to WO1, and IN2 to WO2), as shown in the figure below.

**Note:**

The TCC selection for each LUT follows the formula:

$$IN[N][i] = TCC[N \% TCC\_Instance\_Number]$$

Where N represents the LUT number.

Before selecting the waveform outputs, the TCC must be configured first.

Figure 37-10. TCC Input Selection



**Serial Communication Output Transmit Inputs (SERCOM)**

The serial engine transmitter output from Serial Communication Interface (SERCOM TX, TXd for USART, MOSI for SPI) can be used as input source for the LUT. The figure below shows an example for LUT0 and LUT1. The SERCOM selection for each LUT follows the formula:

$$IN[N][i] = SERCOM[N \% SERCOM\_Instance\_Number]$$

With  $N$  representing the LUT number and  $i=0,1,2$  representing the LUT input index.

Before selecting the SERCOM as input source, the SERCOM must be configured first: the SERCOM TX signal must be output on SERCOMn/pad[0], which serves as input pad to the CCL.

Figure 37-11. SERCOM Input Selection



**Related Links**

- [I/O Multiplexing and Considerations](#)
- [PORT: IO Pin Controller](#)
- [GCLK - Generic Clock Controller](#)
- [AC – Analog Comparators](#)
- [TC – Timer/Counter](#)
- [TCC – Timer/Counter for Control Applications](#)
- [SERCOM – Serial Communication Interface](#)
- [I/O Multiplexing and Considerations](#)

**37.6.2.5 Filter**

By default, the LUT output is a combinatorial function of the LUT inputs. This may cause some short glitches when the inputs change value. These glitches can be removed by clocking through filters, if demanded by application needs.

The Filter Selection bits in LUT Control register (LUTCTRLx.FILTSEL) define the synchronizer or digital filter options. When a filter is enabled, the OUT output will be delayed by two to five GCLK cycles. One APB clock after the corresponding LUT is disabled, all internal filter logic is cleared.

**Note:** Events used as LUT input will also be filtered, if the filter is enabled.

Figure 37-12. Filter



### 37.6.2.6 Edge Detector

The edge detector can be used to generate a pulse when detecting a rising edge on its input. To detect a falling edge, the TRUTH table should be inverted.

The edge detector is enabled by writing '1' to the Edge Selection bit in LUT Control register (LUTCTRLx.EDGESEL). In order to avoid unpredictable behavior, either the filter or synchronizer must be enabled.

Edge detection is disabled by writing a '0' to LUTCTRLx.EDGESEL. After disabling a LUT, the corresponding internal Edge Detector logic is cleared one APB clock cycle later.

Figure 37-13. Edge Detector



### 37.6.2.7 Sequential Logic

Each LUT pair can be connected to the internal sequential logic which can be configured to work as D flip flop, JK flip flop, gated D-latch or RS-latch by writing the Sequential Selection bits on the corresponding Sequential Control x register (SEQCTRLx.SEQSEL). Before using sequential logic, the GCLK\_CCL clock and optionally each LUT filter or edge detector must be enabled.

**Note:** While configuring the sequential logic, the even LUT must be disabled. When configured the even LUT must be enabled.

#### Gated D Flip-Flop (DFF)

When the DFF is selected, the D-input is driven by the even LUT output (LUT0 and LUT2), and the G-input is driven by the odd LUT output (LUT1 and LUT3), as shown in [Figure 37-14](#).

Figure 37-14. D Flip Flop



When the even LUT is disabled (LUTCTRL0.ENABLE=0 / LUTCTRL2.ENABLE=0), the flip-flop is asynchronously cleared. The reset command (R) is kept enabled for one APB clock cycle. In all other cases, the flip-flop output (OUT) is refreshed on rising edge of the GCLK\_CCL, as shown in Table 37-2.

Table 37-2. DFF Characteristics

R	G	D	OUT
1	X	X	Clear
0	1	1	Set
		0	Clear
0	0	X	Hold state (no change)

**JK Flip-Flop (JK)**

When this configuration is selected, the J-input is driven by the even LUT output (LUT0 and LUT2), and the K-input is driven by the odd LUT output (LUT1 and LUT3), as shown in Figure 37-15.

Figure 37-15. JK Flip Flop



When the even LUT is disabled (LUTCTRL0.ENABLE=0 / LUTCTRL2.ENABLE=0), the flip-flop is asynchronously cleared. The reset command (R) is kept enabled for one APB clock cycle. In all other cases, the flip-flop output (OUT) is refreshed on rising edge of the GCLK\_CCL, as shown in Table 37-3.

Table 37-3. JK Characteristics

R	J	K	OUT
1	X	X	Clear
0	0	0	Hold state (no change)
0	0	1	Clear
0	1	0	Set
0	1	1	Toggle

**Gated D-Latch (DLATCH)**

When the DLATCH is selected, the D-input is driven by the even LUT output (LUT0 and LUT2), and the G-input is driven by the odd LUT output (LUT1 and LUT3), as shown in Figure 37-14.

Figure 37-16. D-Latch



When the even LUT is disabled (LUTCTRL0.ENABLE=0 / LUTCTRL2.ENABLE=0), the latch output will be cleared. The G-input is forced enabled for one more APB clock cycle, and the D-input to zero. In all other cases, the latch output (OUT) is refreshed as shown in [Table 37-4](#).

Table 37-4. D-Latch Characteristics

G	D	OUT
0	X	Hold state (no change)
1	0	Clear
1	1	Set

**RS Latch (RS)**

When this configuration is selected, the S-input is driven by the even LUT output (LUT0 and LUT2), and the R-input is driven by the odd LUT output (LUT1 and LUT3), as shown in [Figure 37-17](#).

Figure 37-17. RS-Latch



When the even LUT is disabled LUTCTRL0.ENABLE=0 / LUTCTRL2.ENABLE=0), the latch output will be cleared. The R-input is forced enabled for one more APB clock cycle and S-input to zero. In all other cases, the latch output (OUT) is refreshed as shown in [Table 37-5](#).

Table 37-5. RS-latch Characteristics

S	R	OUT
0	0	Hold state (no change)
0	1	Clear
1	0	Set
1	1	Forbidden state

**37.6.3 Events**

The CCL can generate the following output events:

- LUTOUTx: Lookup Table Output Value

Writing a '1' to the LUT Control Event Output Enable bit (LUTCTRL.LUTEO) enables the corresponding output event. Writing a '0' to this bit disables the corresponding output event. Refer to *EVSYS – Event System* for details on configuration.

The CCL can take the following actions on an input event:

- INx: The event is used as input for the TRUTH table. For further details refer to [Events](#).

Writing a '1' to the LUT Control Event Input Enable bit (LUTCTRL.LUTEI) enables the corresponding action on input event. Writing a '0' to this bit disables the corresponding action on input event. Refer to *EVSYS – Event System* for details on configuration.

#### Related Links

[EVSYS – Event System](#)

#### 37.6.4 Sleep Mode Operation

When using the GCLK\_CCL internal clocking, writing the Run In Standby bit in the Control register (CTRL.RUNSTDBY) to '1' will allow GCLK\_CCL to be enabled in all sleep modes.

If CTRL.RUNSTDBY=0, the GCLK\_CCL will be disabled. If the Filter, Edge Detector or Sequential logic are enabled, the LUT output will be forced to zero in STANDBY mode. In all other cases, the TRUTH table decoder will continue operation and the LUT output will be refreshed accordingly.



### 37.7 Register Summary

Offset	Name	Bit Pos.							
0x00	CTRL	7:0		RUNSTDBY					ENABLE SWRST
0x01	Reserved								
...									
0x03									
0x04	SEQCTRL0	7:0							SEQSEL[3:0]
0x05	SEQCTRL1	7:0							SEQSEL[3:0]
0x06	Reserved								
...									
0x07									
0x08	LUTCTRL0	7:0	EDGESEL			FILTSEL[1:0]			ENABLE
0x09		15:8	INSELx[3:0]			INSELx[3:0]			
0x0A		23:16		LUTEO	LUTEI	INVEI	INSELx[3:0]		
0x0B		31:24	TRUTH[7:0]						
0x0C	LUTCTRL1	7:0	EDGESEL			FILTSEL[1:0]			ENABLE
0x0D		15:8	INSELx[3:0]			INSELx[3:0]			
0x0E		23:16		LUTEO	LUTEI	INVEI	INSELx[3:0]		
0x0F		31:24	TRUTH[7:0]						
0x10	LUTCTRL2	7:0	EDGESEL			FILTSEL[1:0]			ENABLE
0x11		15:8	INSELx[3:0]			INSELx[3:0]			
0x12		23:16		LUTEO	LUTEI	INVEI	INSELx[3:0]		
0x13		31:24	TRUTH[7:0]						
0x14	LUTCTRL3	7:0	EDGESEL			FILTSEL[1:0]			ENABLE
0x15		15:8	INSELx[3:0]			INSELx[3:0]			
0x16		23:16		LUTEO	LUTEI	INVEI	INSELx[3:0]		
0x17		31:24	TRUTH[7:0]						

### 37.8 Register Description

Registers can be 8, 16, or 32 bits wide. Atomic 8-, 16- and 32-bit accesses are supported. In addition, the 8-bit quarters and 16-bit halves of a 32-bit register, and the 8-bit halves of a 16-bit register can be accessed directly.

Some registers are optionally write-protected by the Peripheral Access Controller (PAC). Optional PAC write-protection is denoted by the "PAC Write-Protection" property in each individual register description. For details, refer to [Register Access Protection](#).

Some registers are enable-protected, meaning they can only be written when the peripheral is disabled. Enable-protection is denoted by the "Enable-Protected" property in each individual register description.

#### 37.8.1 Control

**Name:** CTRL  
**Offset:** 0x00 [ID-00000485]  
**Reset:** 0x00  
**Property:** PAC Write-Protection

Bit	7	6	5	4	3	2	1	0
		RUNSTDBY					ENABLE	SWRST
Access		R/W					R/W	W
Reset		0					0	0

### Bit 6 – RUNSTDBY: Run in Standby

This bit indicates if the GCLK\_CCL clock must be kept running in standby mode. The setting is ignored for configurations where the generic clock is not required. For details refer to [Sleep Mode Operation](#).

Value	Description
0	Generic clock is not required in standby sleep mode.
1	Generic clock is required in standby sleep mode.

### Bit 1 – ENABLE: Enable

Value	Description
0	The peripheral is disabled.
1	The peripheral is enabled.

### Bit 0 – SWRST: Software Reset

Writing a '0' to this bit has no effect.

Writing a '1' to this bit resets all registers in the CCL to their initial state.

Value	Description
0	There is no reset operation ongoing.
1	The reset operation is ongoing.

## 37.8.2 Sequential Control x

**Name:** SEQCTRL

**Offset:** 0x04 + n\*0x01 [n=0..1]

**Reset:** 0x00

**Property:** PAC Write-Protection, Enable-Protected

Bit	7	6	5	4	3	2	1	0
					SEQSEL[3:0]			
Access					R/W	R/W	R/W	R/W
Reset					0	0	0	0

### Bits 3:0 – SEQSEL[3:0]: Sequential Selection

These bits select the sequential configuration:

Sequential Selection

Value	Name	Description
0x0	DISABLE	Sequential logic is disabled
0x1	DFF	D flip flop
0x2	JK	JK flip flop
0x3	LATCH	D latch
0x4	RS	RS latch
0x5 - 0xF		Reserved

## 37.8.3 LUT Control x

**Name:** LUTCTRL

**Offset:** 0x08 + n\*0x04 [n=0..3]

**Reset:** 0x00000000

**Property:** PAC Write-Protection, Enable-Protected (except LUTEN)

Bit	31	30	29	28	27	26	25	24
	TRUTH[7:0]							
Access	R/W	R/W	R/W	R/W	R/W	R/W	R/W	R/W
Reset	0	0	0	0	0	0	0	0
Bit	23	22	21	20	19	18	17	16
		LUTEO	LUTEI	INVEI	INSELx[3:0]			
Access		R/W	R/W	R/W	R/W	R/W	R/W	R/W
Reset		0	0	0	0	0	0	0
Bit	15	14	13	12	11	10	9	8
	INSELx[3:0]				INSELx[3:0]			
Access	R/W	R/W	R/W	R/W	R/W	R/W	R/W	R/W
Reset	0	0	0	0	0	0	0	0
Bit	7	6	5	4	3	2	1	0
	EDGESEL		FILTSEL[1:0]				ENABLE	
Access	R/W		R/W	R/W			R/W	
Reset	0		0	0			0	

### Bits 31:24 – TRUTH[7:0]: Truth Table

These bits define the value of truth logic as a function of inputs IN[2:0].

### Bit 22 – LUTEO: LUT Event Output Enable

Value	Description
0	LUT event output is disabled.
1	LUT event output is enabled.

### Bit 21 – LUTEI: LUT Event Input Enable

Value	Description
0	LUT incoming event is disabled.
1	LUT incoming event is enabled.

### Bit 20 – INVEI: Inverted Event Input Enable

Value	Description
0	Incoming event is not inverted.
1	Incoming event is inverted.

### Bit 7 – EDGESEL: Edge Selection

Value	Description
0	Edge detector is disabled.
1	Edge detector is enabled.

### Bits 5:4 – FILTSEL[1:0]: Filter Selection

These bits select the LUT output filter options:

Filter Selection

Value	Name	Description
0x0	DISABLE	Filter disabled
0x1	SYNCH	Synchronizer enabled
0x2	FILTER	Filter enabled
0x3	-	Reserved

### Bit 1 – ENABLE: LUT Enable

Value	Description
0	The LUT is disabled.
1	The LUT is enabled.

### Bits 19:16,15:12,11:8 – INSELx: LUT Input x Source Selection

These bits select the LUT input x source:

Value	Name	Description
0x0	MASK	Masked input
0x1	FEEDBACK	Feedback input source
0x2	LINK	Linked LUT input source
0x3	EVENT	Event input source
0x4	IO	I/O pin input source
0x5	AC	AC input source
0x6	TC	TC input source
0x7	ALTTC	Alternative TC input source
0x8	TCC	TCC input source
0x9	SERCOM	SERCOM input source

## 38. ADC – Analog-to-Digital Converter

### 38.1 Overview

The Analog-to-Digital Converter (ADC) converts analog signals to digital values. The ADC has up to 12-bit resolution, and is capable of a sampling rate of up to 1MSPS. The input selection is flexible, and both differential and single-ended measurements can be performed. In addition, several internal signal inputs are available. The ADC can provide both signed and unsigned results.

ADC measurements can be started by either application software or an incoming event from another peripheral in the device. ADC measurements can be started with predictable timing, and without software intervention.

Both internal and external reference voltages can be used.

The bandgap voltage as well as the scaled I/O and core voltages can also be measured by the ADC.

The ADC has a compare function for accurate monitoring of user-defined thresholds, with minimum software intervention required.

The ADC can be configured for 8-, 10- or 12-bit results. ADC conversion results are provided left- or right-adjusted, which eases calculation when the result is represented as a signed value. It is possible to use DMA to move ADC results directly to memory or peripherals when conversions are done.

### 38.2 Features

- 8-, 10- or 12-bit resolution
- Up to 1,000,000 samples per second (1MSPS)
- Differential and single-ended inputs
  - Up to 12 analog inputs
  - 16 positive and 7 negative, including internal and external
- Internal inputs:
  - Bandgap voltage
  - Scaled core supply
  - Scaled I/O supply
- Single, continuous and sequencing options
- Windowing monitor with selectable channel
- Conversion range:  $V_{ref} = [2.0V \text{ to } VDD_{ANA}]$
- Built-in internal reference and external reference options
- Event-triggered conversion for accurate timing (one event input)
- Optional DMA transfer of conversion settings or result
- Hardware gain and offset compensation
- Averaging and oversampling with decimation to support up to 16-bit result
- Selectable sampling time
- Flexible Power / Throughput rate management

### 38.3 Block Diagram

Figure 38-1. ADC Block Diagram



### 38.4 Signal Description

Signal	Description	Type
VREFA	Analog input	External reference voltage
AIN[11..0]	Analog input	Analog input channels

**Note:** One signal can be mapped on several pins.

**Related Links**

- [Configuration Summary](#)
- [I/O Multiplexing and Considerations](#)

### 38.5 Product Dependencies

In order to use this peripheral, other parts of the system must be configured correctly, as described below.

#### 38.5.1 I/O Lines

Using the ADC's I/O lines requires the I/O pins to be configured using the port configuration (PORT).

## Related Links

[PORT: IO Pin Controller](#)

### 38.5.2 Power Management

The ADC will continue to operate in any sleep mode where the selected source clock is running. The ADC's interrupts can be used to wake up the device from sleep modes. Events connected to the event system can trigger other operations in the system without exiting sleep modes.

## Related Links

[PM – Power Manager](#)

### 38.5.3 Clocks

The ADC bus clock (CLK\_APB\_ADCx) can be enabled in the Main Clock, which also defines the default state.

The ADC requires a generic clock (GCLK\_ADC). This clock must be configured and enabled in the Generic Clock Controller (GCLK) before using the ADC.

A generic clock is asynchronous to the bus clock. Due to this asynchronicity, writes to certain registers will require synchronization between the clock domains. Refer to *Synchronization* for further details.

## Related Links

[Synchronization](#)

[Peripheral Clock Masking](#)

[GCLK - Generic Clock Controller](#)

### 38.5.4 DMA

The DMA request line is connected to the DMA Controller (DMAC). Using the ADC DMA requests requires the DMA Controller to be configured first.

## Related Links

[DMAC – Direct Memory Access Controller](#)

### 38.5.5 Interrupts

The interrupt request line is connected to the interrupt controller. Using the ADC interrupt requires the interrupt controller to be configured first.

## Related Links

[Nested Vector Interrupt Controller](#)

### 38.5.6 Events

The events are connected to the Event System.

## Related Links

[EVSYS – Event System](#)

### 38.5.7 Debug Operation

When the CPU is halted in debug mode the ADC will halt normal operation. The ADC can be forced to continue operation during debugging. Refer to DBGCTRL register for details.

### 38.5.8 Register Access Protection

All registers with write-access are optionally write-protected by the peripheral access controller (PAC), except the following register:

- Interrupt Flag Status and Clear (INTFLAG) register

Optional write-protection by the Peripheral Access Controller (PAC) is denoted by the "PAC Write-Protection" property in each individual register description.

PAC write-protection does not apply to accesses through an external debugger.

#### Related Links

[PAC - Peripheral Access Controller](#)

### 38.5.9 Analog Connections

I/O-pins (AINx), as well as the VREFx reference voltage pins are analog inputs to the ADC.

### 38.5.10 Calibration

The BIAS and LINEARITY calibration values from the production test must be loaded from the NVM Software Calibration Area into the ADC Calibration register (CALIB) by software to achieve specified accuracy.

#### Related Links

[NVM Software Calibration Area Mapping](#)

## 38.6 Functional Description

### 38.6.1 Principle of Operation

By default, the ADC provides results with 12-bit resolution. 8-bit or 10-bit results can be selected in order to reduce the conversion time, see [Conversion Timing and Sampling Rate](#).

The ADC has an oversampling with decimation option that can extend the resolution to 16 bits. The input values can be either internal or external (connected I/O pins). The user can also configure whether the conversion should be single-ended or differential.

### 38.6.2 Basic Operation

#### 38.6.2.1 Initialization

The following registers are enable-protected, meaning that they can only be written when the ADC is disabled (CTRLA.ENABLE=0):

- Control B register (CTRLB)
- Reference Control register (REFCTRL)
- Event Control register (EVCTRL)
- Calibration register (CALIB)

Enable-protection is denoted by the "Enable-Protected" property in the register description.

#### 38.6.2.2 Enabling, Disabling and Resetting

The ADC is enabled by writing a '1' to the Enable bit in the Control A register (CTRLA.ENABLE). The ADC is disabled by writing CTRLA.ENABLE=0.

The ADC is reset by writing a '1' to the Software Reset bit in the Control A register (CTRLA.SWRST). All registers in the ADC, except DBGCTRL, will be reset to their initial state, and the ADC will be disabled. Refer to [CTRLA](#) for details.



### 38.6.2.3 Operation

In the most basic configuration, the ADC samples values from the configured internal or external sources (INPUTCTRL register). The rate of the conversion depends on the combination of the GCLK\_ADC frequency and the clock prescaler.

To convert analog values to digital values, the ADC needs to be initialized first, as described in the Initialization section. Data conversion can be started either manually by setting the Start bit in the Software Trigger register (SWTRIG.START=1), or automatically by configuring an automatic trigger to initiate the conversions. A free-running mode can be used to continuously convert an input channel. When using free-running mode the first conversion must be started, while subsequent conversions will start automatically at the end of previous conversions.

The result of the conversion is stored in the Result register (RESULT) overwriting the result from the previous conversion.

To avoid data loss if more than one channel is enabled, the conversion result must be read as soon as it is available (INTFLAG.RESRDY). Failing to do so will result in an overrun error condition, indicated by the OVERRUN bit in the Interrupt Flag Status and Clear register (INTFLAG.OVERRUN).

To enable one of the available interrupts sources, the corresponding bit in the Interrupt Enable Set register (INTENSET) must be written to '1'.

### 38.6.2.4 Prescaler Selection

The ADC is clocked by GCLK\_ADC. There is also a prescaler in the ADC to enable conversion at lower clock rates. Refer to CTRLB for details on prescaler settings. Refer to [Conversion Timing and Sampling Rate](#) for details on timing and sampling rate.

**Figure 38-2. ADC Prescaler**



**Note:** The minimum prescaling factor is DIV2.

### 38.6.2.5 Reference Configuration

The ADC has various sources for its reference voltage  $V_{REF}$ . The Reference Voltage Selection bit field in the Reference Control register (REFCTRL.REFSEL) determines which reference is selected. By default, the internal voltage reference INTREF is selected. Based on customer application requirements, the external or internal reference can be selected. Refer to REFCTRL.REFSEL for further details on available selections.

#### Related Links

[REFCTRL](#)

## Analog-to-Digital Converter (ADC) Characteristics

### 38.6.2.6 ADC Resolution

The ADC supports 8-bit, 10-bit or 12-bit resolution. Resolution can be changed by writing the Resolution bit group in the Control C register (CTRLC.RESSEL). By default, the ADC resolution is set to 12 bits. The resolution affects the propagation delay, see also [Conversion Timing and Sampling Rate](#).

### 38.6.2.7 Differential and Single-Ended Conversions

The ADC has two conversion options: differential and single-ended:

If the positive input is always positive, the single-ended conversion should be used in order to have full 12-bit resolution in the conversion.

If the positive input may go below the negative input, the differential mode should be used in order to get correct results.

The differential mode is enabled by setting DIFFMODE bit in the Control C register (CTRLC.DIFFMODE). Both conversion types could be run in single mode or in free-running mode. When the free-running mode is selected, an ADC input will continuously sample the input and performs a new conversion. The INTFLAG.RESRDY bit will be set at the end of each conversion.

### 38.6.2.8 Conversion Timing and Sampling Rate

The following figure shows the ADC timing for one single conversion. A conversion starts after the software or event start are synchronized with the GCLK\_ADC clock. The input channel is sampled in the first half CLK\_ADC period.

**Figure 38-3. ADC Timing for One Conversion in 12-bit Resolution**



The sampling time can be increased by using the Sampling Time Length bit group in the Sampling Time Control register (SAMPCTRL.SAMPLEN). As example, the next figure is showing the timing conversion with sampling time increased to six CLK\_ADC cycles.

**Figure 38-4. ADC Timing for One Conversion with Increased Sampling Time, 12-bit**



The ADC provides also offset compensation, see the following figure. The offset compensation is enabled by the Offset Compensation bit in the Sampling Control register (SAMPCTRL.OFFCOMP).

**Note:** If offset compensation is used, the sampling time must be set to one cycle of CLK\_ADC.

In free running mode, the sampling rate  $R_S$  is calculated by

$$R_S = f_{CLK\_ADC} / (n_{SAMPLING} + n_{OFFCOMP} + n_{DATA})$$

Here,  $n_{SAMPLING}$  is the sampling duration in CLK\_ADC cycles,  $n_{OFFCOMP}$  is the offset compensation duration in clock cycles, and  $n_{DATA}$  is the bit resolution.  $f_{CLK\_ADC}$  is the ADC clock frequency from the internal prescaler:  $f_{CLK\_ADC} = f_{GCLK\_ADC} / 2^{(1 + CTRLB.PRESCALER)}$

**Figure 38-5. ADC Timing for One Conversion with Offset Compensation, 12-bit**

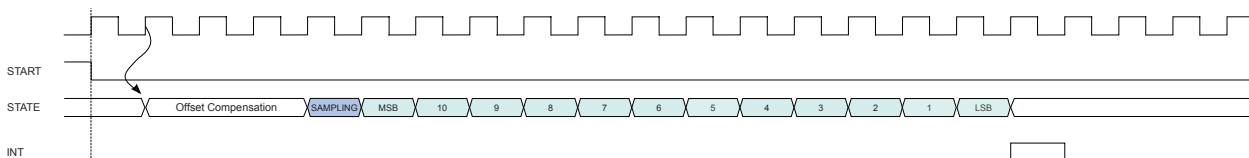

The impact of resolution on the sampling rate is seen in the next two figures, where free-running sampling in 12-bit and 8-bit resolution are compared.

**Figure 38-6. ADC Timing for Free Running in 12-bit Resolution**

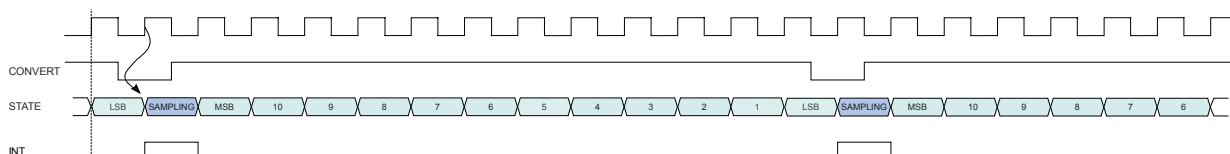

**Figure 38-7. ADC Timing for Free Running in 8-bit Resolution**

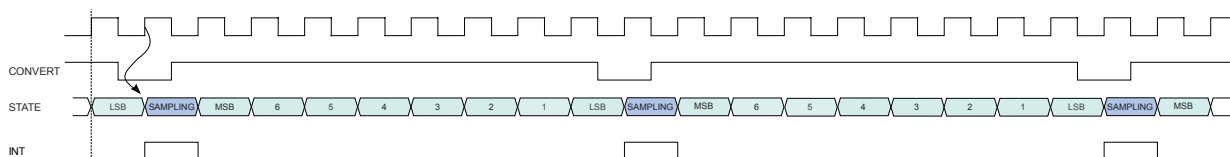

The propagation delay of an ADC measurement is given by:

$$\text{PropagationDelay} = \frac{1 + \text{Resolution}}{f_{\text{ADC}}}$$

**Example.** In order to obtain 1MSPS in 12-bit resolution with a sampling time length of four CLK\_ADC cycles,  $f_{\text{CLK\_ADC}}$  must be  $1\text{MSPS} * (4 + 12) = 16\text{MHz}$ . As the minimal division factor of the prescaler is 2,  $\text{GCLK\_ADC}$  must be 32MHz.

### 38.6.2.9 Accumulation

The result from multiple consecutive conversions can be accumulated. The number of samples to be accumulated is specified by the Sample Number field in the Average Control register (AVGCTRL.SAMPLENUM). When accumulating more than 16 samples, the result will be too large to match the 16-bit RESULT register size. To avoid overflow, the result is right shifted automatically to fit within the available register size. The number of automatic right shifts is specified in the table below.

**Note:** To perform the accumulation of two or more samples, the Conversion Result Resolution field in the Control C register (CTRLC.RESSEL) must be set.

**Table 38-1. Accumulation**

Number of Accumulated Samples	AVGCTRL.SAMPLENUM	Number of Automatic Right Shifts	Final Result Precision	Automatic Division Factor
1	0x0	0	12 bits	0
2	0x1	0	13 bits	0

Number of Accumulated Samples	AVGCTRL.SAMPLENUM	Number of Automatic Right Shifts	Final Result Precision	Automatic Division Factor
4	0x2	0	14 bits	0
8	0x3	0	15 bits	0
16	0x4	0	16 bits	0
32	0x5	1	16 bits	2
64	0x6	2	16 bits	4
128	0x7	3	16 bits	8
256	0x8	4	16 bits	16
512	0x9	5	16 bits	32
1024	0xA	6	16 bits	64
Reserved	0xB –0xF		12 bits	0

### 38.6.2.10 Averaging

Averaging is a feature that increases the sample accuracy, at the cost of a reduced sampling rate. This feature is suitable when operating in noisy conditions.

Averaging is done by accumulating *m* samples, as described in [Accumulation](#), and dividing the result by *m*. The averaged result is available in the RESULT register. The number of samples to be accumulated is specified by writing to AVGCTRL.SAMPLENUM as shown in [Table 38-2](#).

The division is obtained by a combination of the automatic right shift described above, and an additional right shift that must be specified by writing to the Adjusting Result/Division Coefficient field in AVGCTRL (AVGCTRL.ADJRES), as described in [Table 38-2](#).

**Note:** To perform the averaging of two or more samples, the Conversion Result Resolution field in the Control C register (CTRLC.RESSEL) must be set.

Averaging AVGCTRL.SAMPLENUM samples will reduce the un-averaged sampling rate by a factor  $\frac{1}{\text{AVGCTRL.SAMPLENUM}}$ .

When the averaged result is available, the INTFLAG.RESRDY bit will be set.

**Table 38-2. Averaging**

Number of Accumulated Samples	AVGCTRL.SAMPLENUM	Intermediate Result Precision	Number of Automatic Right Shifts	Division Factor	AVGCTRL.ADJRES	Total Number of Right Shifts	Final Result Precision	Automatic Division Factor
1	0x0	12 bits	0	1	0x0		12 bits	0
2	0x1	13	0	2	0x1	1	12 bits	0
4	0x2	14	0	4	0x2	2	12 bits	0
8	0x3	15	0	8	0x3	3	12 bits	0
16	0x4	16	0	16	0x4	4	12 bits	0
32	0x5	17	1	16	0x4	5	12 bits	2

Number of Accumulated Samples	AVGCTRL.SAMPLENUM	Intermediate Result Precision	Number of Automatic Right Shifts	Division Factor	AVGCTRL.ADJRES	Total Number of Right Shifts	Final Result Precision	Automatic Division Factor
64	0x6	18	2	16	0x4	6	12 bits	4
128	0x7	19	3	16	0x4	7	12 bits	8
256	0x8	20	4	16	0x4	8	12 bits	16
512	0x9	21	5	16	0x4	9	12 bits	32
1024	0xA	22	6	16	0x4	10	12 bits	64
Reserved	0xB–0xF				0x0		12 bits	0

### 38.6.2.11 Oversampling and Decimation

By using oversampling and decimation, the ADC resolution can be increased from 12 bits up to 16 bits, for the cost of reduced effective sampling rate.

To increase the resolution by  $n$  bits,  $4^n$  samples must be accumulated. The result must then be right-shifted by  $n$  bits. This right-shift is a combination of the automatic right-shift and the value written to AVGCTRL.ADJRES. To obtain the correct resolution, the ADJRES must be configured as described in the table below. This method will result in  $n$  bit extra LSB resolution.

**Table 38-3. Configuration Required for Oversampling and Decimation**

Result Resolution	Number of Samples to Average	AVGCTRL.SAMPLENUM[3:0]	Number of Automatic Right Shifts	AVGCTRL.ADJRES[2:0]
13 bits	$4^1 = 4$	0x2	0	0x1
14 bits	$4^2 = 16$	0x4	0	0x2
15 bits	$4^3 = 64$	0x6	2	0x1
16 bits	$4^4 = 256$	0x8	4	0x0

### 38.6.2.12 Automatic Sequences

The ADC has the ability to automatically sequence a series of conversions. This means that each time the ADC receives a start-of-conversion request, it can perform multiple conversions automatically. All of the 32 positive inputs can be included in a sequence by writing to corresponding bits in the Sequence Control register (SEQCTRL). The order of the conversion in a sequence is the lower positive MUX selection to upper positive MUX (AIN0, AIN1, AIN2 ...). In differential mode, the negative inputs selected by MUXNEG field, will be used for the entire sequence.

When a sequence starts, the Sequence Busy status bit in Sequence Status register (SEQSTATUS.SEQBUSY) will be set. When the sequence is complete, the Sequence Busy status bit will be cleared.

Each time a conversion is completed, the Sequence State bit in Sequence Status register (SEQSTATUS.SEQSTATE) will store the input number from which the conversion is done. The result will be stored in the RESULT register, and the Result Ready Interrupt Flag (INTFLAG.RESRDY) is set.

If additional inputs must be scanned, the ADC will automatically start a new conversion on the next input present in the sequence list.

Note that if SEQCTRL register has no bits set to '1', the conversion is done with the selected MUXPOS input.

**38.6.2.13 Window Monitor**

The window monitor feature allows the conversion result in the RESULT register to be compared to predefined threshold values. The window mode is selected by setting the Window Monitor Mode bits in the Control C register (CTRLC.WINMODE). Threshold values must be written in the Window Monitor Lower Threshold register (WINLT) and Window Monitor Upper Threshold register (WINUT).

If differential input is selected, the WINLT and WINUT are evaluated as signed values. Otherwise they are evaluated as unsigned values. The significant WINLT and WINUT bits are given by the precision selected in the Conversion Result Resolution bit group in the Control C register (CTRLC.RESSEL). This means that for example in 8-bit mode, only the eight lower bits will be considered. In addition, in differential mode, the eighth bit will be considered as the sign bit, even if the ninth bit is zero.

The INTFLAG.WINMON interrupt flag will be set if the conversion result matches the window monitor condition.

**38.6.2.14 Offset and Gain Correction**

Inherent gain and offset errors affect the absolute accuracy of the ADC.

The offset error is defined as the deviation of the actual ADC transfer function from an ideal straight line at zero input voltage. The offset error cancellation is handled by the Offset Correction register (OFFSETCORR). The offset correction value is subtracted from the converted data before writing the Result register (RESULT).

The gain error is defined as the deviation of the last output step's midpoint from the ideal straight line, after compensating for offset error. The gain error cancellation is handled by the Gain Correction register (GAINCORR).

To correct these two errors, the Digital Correction Logic Enabled bit in the Control C register (CTRLC.CORREN) must be set.

Offset and gain error compensation results are both calculated according to:

$$\text{Result} = (\text{Conversion value} + \text{OFFSETCORR}) \cdot \text{GAINCORR}$$

The correction will introduce a latency of 13 CLK\_ADC clock cycles. In free running mode this latency is introduced on the first conversion only, since its duration is always less than the propagation delay. In single conversion mode this latency is introduced for each conversion.

**Figure 38-8. ADC Timing Correction Enabled**



## 38.6.3 Additional Features

### 38.6.3.1 Rail-to-Rail Operation

The accuracy of the ADC is highest when the input common mode voltage ( $V_{\text{CMIN}}$ ) is close to  $V_{\text{REF}}/2$ . To enable a full range of common mode voltages (rail-to-rail operation), the Rail-to-Rail bit in the Control C register (CTRLC.R2R) should be written to one. Rail-to-rail operation requires a sampling period of four cycles. This is achieved by enabling offset compensation (SAMPCTRL.OFFCOMP = 1). Rail-to-rail operation should not be used when offset compensation is disabled.

### 38.6.3.2 Double Buffering

The following registers are double buffered:

- Input Control (INPUTCTRL)
- Control C (CTRLC)
- Average Control (AVGCTRL)
- Sampling Time Control (SAMPCTRL)
- Window Monitor Lower Threshold (WINLT)
- Window Monitor Upper Threshold (WINUT)
- Gain Correction (GAINCORR)
- Offset Correction (OFFSETCORR)

When one of these registers is written, the data is stored in the corresponding buffer as long as the current conversion is not impacted, and the corresponding busy status will be set in the Synchronization Busy register (SYNCBUSY). When a new RESULT is available, data stored in the buffer registers will be transferred to the ADC and a new conversion can start.

## 38.6.4 DMA Operation

The ADC generates the following DMA request:

- Result Conversion Ready (RESRDY): the request is set when a conversion result is available and cleared when the RESULT register is read. When the averaging operation is enabled, the DMA request is set when the averaging is completed and result is available.

## 38.6.5 Interrupts

The ADC has the following interrupt sources:

- Result Conversion Ready: RESRDY
- Window Monitor: WINMON
- Overrun: OVERRUN

These interrupts are asynchronous wake-up sources. See *Sleep Mode Controller* for details.

Each interrupt source has an interrupt flag associated with it. The interrupt flag in the Interrupt Flag Status and Clear (INTFLAG) register is set when the interrupt condition occurs. Each interrupt can be individually enabled by writing a one to the corresponding bit in the Interrupt Enable Set (INTENSET) register, and disabled by writing a one to the corresponding bit in the Interrupt Enable Clear (INTENCLR) register. An interrupt request is generated when the interrupt flag is set and the corresponding interrupt is enabled. The interrupt request remains active until the interrupt flag is cleared, the interrupt is disabled, or the ADC is reset. See INTFLAG register for details on how to clear interrupt flags. All interrupt requests from the peripheral are ORed together on system level to generate one combined interrupt request to the NVIC. Refer to *Nested Vector Interrupt Controller* for details. The user must read the INTFLAG register to determine which interrupt condition is present.

Note that interrupts must be globally enabled for interrupt requests to be generated. Refer to *Nested Vector Interrupt Controller* for details.

## Related Links

[Nested Vector Interrupt Controller](#)

[Sleep Mode Controller](#)

[INTENCLR](#)

[INTENSET](#)

[INTFLAG](#)

### 38.6.6 Events

The ADC can generate the following output events:

- Result Ready (RESRDY): Generated when the conversion is complete and the result is available. Refer to [EVCTRL](#) for details.
- Window Monitor (WINMON): Generated when the window monitor condition match. Refer to [CTRLC](#) for details.

Setting an Event Output bit in the Event Control Register (EVCTRL.xxE0=1) enables the corresponding output event. Clearing this bit disables the corresponding output event. Refer to the Event System chapter for details on configuring the event system.

The ADC can take the following actions on an input event:

- Start conversion (START): Start a conversion. Refer to [SWTRIG](#) for details.
- Conversion flush (FLUSH): Flush the conversion. Refer to [SWTRIG](#) for details.

Setting an Event Input bit in the Event Control register (EVCTRL.xxEI=1) enables the corresponding action on input event. Clearing this bit disables the corresponding action on input event.

The ADC uses only asynchronous events, so the asynchronous Event System channel path must be configured. By default, the ADC will detect a rising edge on the incoming event. If the ADC action must be performed on the falling edge of the incoming event, the event line must be inverted first. This is done by setting the corresponding Event Invert Enable bit in Event Control register (EVCTRL.xINV=1).

**Note:** If several events are connected to the ADC, the enabled action will be taken on any of the incoming events. If FLUSH and START events are available at the same time, the FLUSH event has priority.

## Related Links

[EVSYS – Event System](#)

### 38.6.7 Sleep Mode Operation

The ONDEMAND and RUNSTDBY bits in the Control A register (CTRLA) control the behavior of the ADC during standby sleep mode, in cases where the ADC is enabled (CTRLA.ENABLE = 1). For further details on available options, refer to [Table 38-4](#).

**Note:** When CTRLA.ONDEMAND=1, the analog block is powered-off when the conversion is complete. When a start request is detected, the system returns from sleep and starts a new conversion after the start-up time delay.



**Table 38-4. ADC Sleep Behavior**

CTRLA.RUNSTDBY	CTRLA.ONDEMAND	CTRLA.ENABLE	Description
x	x	0	Disabled
0	0	1	Run in all sleep modes except STANDBY.
0	1	1	Run in all sleep modes on request, except STANDBY.
1	0	1	Run in all sleep modes.
1	1	1	Run in all sleep modes on request.

### 38.6.8 Synchronization

Due to asynchronicity between the main clock domain and the peripheral clock domains, some registers need to be synchronized when written or read.

The following bits are synchronized when written:

- Software Reset bit in Control A register (CTRLA.SWRST)
- Enable bit in Control A register (CTRLA.ENABLE)

The following registers are synchronized when written:

- Input Control register (INPUTCTRL)
- Control C register (CTRLC)
- Average control register (AVGCTRL)
- Sampling time control register (SAMPCTRL)
- Window Monitor Lower Threshold register (WINLT)
- Window Monitor Upper Threshold register (WINUT)
- Gain correction register (GAINCORR)
- Offset Correction register (OFFSETCORR)
- Software Trigger register (SWTRIG)

Required write-synchronization is denoted by the "Write-Synchronized" property in the register description.

#### Related Links

[Register Synchronization](#)

## 38.7 Register Summary

Offset	Name	Bit Pos.								
0x00	CTRLA	7:0	ONDEMAND	RUNSTDBY					ENABLE	SWRST
0x01	CTRLB	7:0						PRESCALER[2:0]		
0x02	REFCTRL	7:0	REFCOMP							
0x03	EVCTRL	7:0			WINMONEO	RESRDYEO	STARTINV	FLUSHINV	STARTEI	FLUSHEI
0x04	INTENCLR	7:0						WINMON	OVERRUN	RESRDY
0x05	INTENSET	7:0						WINMON	OVERRUN	RESRDY
0x06	INTFLAG	7:0						WINMON	OVERRUN	RESRDY
0x07	SEQSTATUS	7:0	SEQBUSY					SEQSTATE[4:0]		
0x08	INPUTCTRL	7:0						MUXPOS[4:0]		
0x09		15:8						MUXNEG[4:0]		
0x0A	CTRLC	7:0	R2R		RESSEL[1:0]	CORREN	FREERUN	LEFTADJ	DIFFMODE	
0x0B		15:8						WINMODE[2:0]		
0x0C	AVGCTRL	7:0			ADJRES[2:0]		SAMPLENUM[3:0]			
0x0D	SAMPCTRL	7:0	OFFCOMP				SAMPLEN[5:0]			
0x0E	WINLT	7:0					WINLT[7:0]			
0x0F		15:8					WINLT[15:8]			
0x10	WINUT	7:0					WINUT[7:0]			
0x11		15:8					WINUT[15:8]			
0x12	GAINCORR	7:0					GAINCORR[7:0]			
0x13		15:8					GAINCORR[11:8]			
0x14	OFFSETCORR	7:0					OFFSETCORR[7:0]			
0x15		15:8					OFFSETCORR[11:8]			
0x16	Reserved									
0x17										
0x18	SWTRIG	7:0						START	FLUSH	
0x19	Reserved									
0x1B										
0x1C	DBGCTRL	7:0							DBGRUN	
0x1D	Reserved									
0x1F										
0x20	SYNCBUSY	7:0	WINUT	WINLT	SAMPCTRL	AVGCTRL	CTRLC	INPUTCTRL	ENABLE	SWRST
0x21		15:8						SWTRIG	OFFSETCORR	GAINCORR
0x22	Reserved									
0x23										
0x24	RESULT	7:0	RESULT[7:0]							
0x25		15:8	RESULT[15:8]							
0x26	Reserved									
0x27										
0x28	SEQCTRL	7:0	SEQENn	SEQENn	SEQENn	SEQENn	SEQENn	SEQENn	SEQENn	SEQENn

Offset	Name	Bit Pos.									
0x29	CALIB	15:8	SEQENn	SEQENn	SEQENn	SEQENn	SEQENn	SEQENn	SEQENn	SEQENn	
0x2A		23:16	SEQENn	SEQENn	SEQENn	SEQENn	SEQENn	SEQENn	SEQENn	SEQENn	
0x2B		31:24	SEQENn	SEQENn	SEQENn	SEQENn	SEQENn	SEQENn	SEQENn	SEQENn	
0x2C		7:0						BIASCOMP[2:0]			
0x2D		15:8						BIASREFBUF[2:0]			

## 38.8 Register Description

Registers can be 8, 16, or 32 bits wide. Atomic 8-, 16- and 32-bit accesses are supported. In addition, the 8-bit quarters and 16-bit halves of a 32-bit register, and the 8-bit halves of a 16-bit register can be accessed directly.

Some registers are optionally write-protected by the Peripheral Access Controller (PAC). Optional PAC write-protection is denoted by the "PAC Write-Protection" property in each individual register description. For details, refer to the section on Synchronization.

Some registers are synchronized when read and/or written. Synchronization is denoted by the "Write-Synchronized" or the "Read-Synchronized" property in each individual register description. For details, refer to Synchronization section.

Some registers are enable-protected, meaning they can only be written when the peripheral is disabled. Enable-protection is denoted by the "Enable-Protected" property in each individual register description.

### 38.8.1 Control A

**Name:** CTRLA

**Offset:** 0x00 [ID-0000120e]

**Reset:** 0x00

**Property:** PAC Write-Protection, Write-Synchronized

Bit	7	6	5	4	3	2	1	0
	ONDEMAND	RUNSTDBY					ENABLE	SWRST
Access	R/W	R/W					R/W	R/W
Reset	0	0					0	0

#### Bit 7 – ONDEMAND: On Demand Control

The On Demand operation mode allows the ADC to be enabled or disabled, depending on other peripheral requests.

In On Demand operation mode, i.e., if the ONDEMAND bit has been previously set, the ADC will only be running when requested by a peripheral. If there is no peripheral requesting the ADC will be in a disable state.

If On Demand is disabled the ADC will always be running when enabled.

In standby sleep mode, the On Demand operation is still active if the CTRLA.RUNSTDBY bit is '1'. If CTRLA.RUNSTDBY is '0', the ADC is disabled.

This bit is not synchronized.

Value	Description
0	The ADC is always on , if enabled.
1	The ADC is enabled, when a peripheral is requesting the ADC conversion. The ADC is disabled if no peripheral is requesting it.

**Bit 6 – RUNSTDBY: Run in Standby**

This bit controls how the ADC behaves during standby sleep mode.

This bit is not synchronized.

Value	Description
0	The ADC is halted during standby sleep mode.
1	The ADC is not stopped in standby sleep mode. If CTRLA.ONDEMAND=1, the ADC will be running when a peripheral is requesting it. If CTRLA.ONDEMAND=0, the ADC will always be running in standby sleep mode.

**Bit 1 – ENABLE: Enable**

Due to synchronization there is delay from writing CTRLA.ENABLE until the peripheral is enabled/disabled. The value written to CTRL.ENABLE will read back immediately and the ENABLE bit in the SYNCBUSY register (SYNCBUSY.ENABLE) will be set. SYNCBUSY.ENABLE will be cleared when the operation is complete.

Value	Description
0	The ADC is disabled.
1	The ADC is enabled.

**Bit 0 – SWRST: Software Reset**

Writing a '0' to this bit has no effect.

Writing a '1' to this bit resets all registers in the ADC, except DBGCTRL, to their initial state, and the ADC will be disabled.

Writing a '1' to CTRL.SWRST will always take precedence, meaning that all other writes in the same write-operation will be discarded.

Due to synchronization there is a delay from writing CTRLA.SWRST until the reset is complete. CTRLA.SWRST and SYNCBUSY.SWRST will both be cleared when the reset is complete.

Value	Description
0	There is no reset operation ongoing.
1	The reset operation is ongoing.

**38.8.2 Control B**

**Name:** CTRLB

**Offset:** 0x01 [ID-0000120e]

**Reset:** 0x00

**Property:** PAC Write-Protection, Enable-Protected

Bit	7	6	5	4	3	2	1	0	
							PRESCALER[2:0]		
Access							R/W	R/W	R/W
Reset							0	0	0

### Bits 2:0 – PRESCALER[2:0]: Prescaler Configuration

This field defines the ADC clock relative to the peripheral clock.

Value	Name	Description
0x0	DIV2	Peripheral clock divided by 2
0x1	DIV4	Peripheral clock divided by 4
0x2	DIV8	Peripheral clock divided by 8
0x3	DIV16	Peripheral clock divided by 16
0x4	DIV32	Peripheral clock divided by 32
0x5	DIV64	Peripheral clock divided by 64
0x6	DIV128	Peripheral clock divided by 128
0x7	DIV256	Peripheral clock divided by 256

### 38.8.3 Reference Control

**Name:** REFCTRL

**Offset:** 0x02 [ID-0000120e]

**Reset:** 0x00

**Property:** PAC Write-Protection, Enable-Protected

Bit	7	6	5	4	3	2	1	0
	REFCOMP							
Access	R/W							
Reset	0							

#### Bit 7 – REFCOMP: Reference Buffer Offset Compensation Enable

The gain error can be reduced by enabling the reference buffer offset compensation. This will decrease the input impedance and thus increase the start-up time of the reference.

Value	Description
0	Reference buffer offset compensation is disabled.
1	Reference buffer offset compensation is enabled.

### 38.8.4 Event Control

**Name:** EVCTRL

**Offset:** 0x03 [ID-0000120e]

**Reset:** 0x00

**Property:** PAC Write-Protection, Enable-Protected

Bit	7	6	5	4	3	2	1	0
			WINMONEO	RESRDYEO	STARTINV	FLUSHINV	STARTEI	FLUSHEI
Access			R/W	R/W	R/W	R/W	R/W	R/W
Reset			0	0	0	0	0	0

### Bit 5 – WINMONEO: Window Monitor Event Out

This bit indicates whether the Window Monitor event output is enabled or not and an output event will be generated when the window monitor detects something.

Value	Description
0	Window Monitor event output is disabled and an event will not be generated.
1	Window Monitor event output is enabled and an event will be generated.

### Bit 4 – RESRDYEO: Result Ready Event Out

This bit indicates whether the Result Ready event output is enabled or not and an output event will be generated when the conversion result is available.

Value	Description
0	Result Ready event output is disabled and an event will not be generated.
1	Result Ready event output is enabled and an event will be generated.

### Bit 3 – STARTINV: Start Conversion Event Invert Enable

Value	Description
0	Start event input source is not inverted.
1	Start event input source is inverted.

### Bit 2 – FLUSHINV: Flush Event Invert Enable

Value	Description
0	Flush event input source is not inverted.
1	Flush event input source is inverted.

### Bit 1 – STARTEI: Start Conversion Event Input Enable

Value	Description
0	A new conversion will not be triggered on any incoming event.
1	A new conversion will be triggered on any incoming event.

### Bit 0 – FLUSHEI: Flush Event Input Enable

Value	Description
0	A flush and new conversion will not be triggered on any incoming event.
1	A flush and new conversion will be triggered on any incoming event.

## 38.8.5 Interrupt Enable Clear

This register allows the user to disable an interrupt without doing a read-modify-write operation. Changes in this register will also be reflected in the Interrupt Enable Set (INTENSET) register.

**Name:** INTENCLR  
**Offset:** 0x04 [ID-0000120e]  
**Reset:** 0x00  
**Property:** PAC Write-Protection

	7	6	5	4	3	2	1	0
						WINMON	OVERRUN	RESRDY
Access						R/W	R/W	R/W
Reset						0	0	0

### Bit 2 – WINMON: Window Monitor Interrupt Enable

Writing a '0' to this bit has no effect.

Writing a '1' to this bit will clear the Window Monitor Interrupt Enable bit, which disables the corresponding interrupt request.

Value	Description
0	The window monitor interrupt is disabled.
1	The window monitor interrupt is enabled, and an interrupt request will be generated when the Window Monitor interrupt flag is set.

### Bit 1 – OVERRUN: Overrun Interrupt Enable

Writing a '0' to this bit has no effect.

Writing a '1' to this bit will clear the Overrun Interrupt Enable bit, which disables the corresponding interrupt request.

Value	Description
0	The Overrun interrupt is disabled.
1	The Overrun interrupt is enabled, and an interrupt request will be generated when the Overrun interrupt flag is set.

### Bit 0 – RESRDY: Result Ready Interrupt Enable

Writing a '0' to this bit has no effect.

Writing a '1' to this bit will clear the Result Ready Interrupt Enable bit, which disables the corresponding interrupt request.

Value	Description
0	The Result Ready interrupt is disabled.
1	The Result Ready interrupt is enabled, and an interrupt request will be generated when the Result Ready interrupt flag is set.

## 38.8.6 Interrupt Enable Set

This register allows the user to enable an interrupt without doing a read-modify-write operation. Changes in this register will also be reflected in the Interrupt Enable Clear (INTENCLR) register.

**Name:** INTENSET  
**Offset:** 0x05 [ID-0000120e]  
**Reset:** 0x00  
**Property:** PAC Write-Protection

Bit	7	6	5	4	3	2	1	0
						WINMON	OVERRUN	RESRDY
Access						R/W	R/W	R/W
Reset						0	0	0

**Bit 2 – WINMON: Window Monitor Interrupt Enable**

Writing a '0' to this bit has no effect.

Writing a '1' to this bit will set the Window Monitor Interrupt bit, which enables the Window Monitor interrupt.

Value	Description
0	The Window Monitor interrupt is disabled.
1	The Window Monitor interrupt is enabled.

**Bit 1 – OVERRUN: Overrun Interrupt Enable**

Writing a '0' to this bit has no effect.

Writing a '1' to this bit will set the Overrun Interrupt bit, which enables the Overrun interrupt.

Value	Description
0	The Overrun interrupt is disabled.
1	The Overrun interrupt is enabled.

**Bit 0 – RESRDY: Result Ready Interrupt Enable**

Writing a '0' to this bit has no effect.

Writing a '1' to this bit will set the Result Ready Interrupt bit, which enables the Result Ready interrupt.

Value	Description
0	The Result Ready interrupt is disabled.
1	The Result Ready interrupt is enabled.

### 38.8.7 Interrupt Flag Status and Clear

**Name:** INTFLAG  
**Offset:** 0x06 [ID-0000120e]  
**Reset:** 0x00  
**Property:** –

Bit	7	6	5	4	3	2	1	0
						WINMON	OVERRUN	RESRDY
Access						R/W	R/W	R/W
Reset						0	0	0

**Bit 2 – WINMON: Window Monitor**

This flag is cleared by writing a '1' to the flag or by reading the RESULT register.

This flag is set on the next GCLK\_ADC cycle after a match with the window monitor condition, and an interrupt request will be generated if INTENCLR/SET.WINMON is '1'.

Writing a '0' to this bit has no effect.

Writing a '1' to this bit clears the Window Monitor interrupt flag.



## Bit 1 – OVERRUN: Overrun

This flag is cleared by writing a '1' to the flag.

This flag is set if RESULT is written before the previous value has been read by CPU, and an interrupt request will be generated if INTENCLR/SET.OVERRUN=1.

Writing a '0' to this bit has no effect.

Writing a '1' to this bit clears the Overrun interrupt flag.

## Bit 0 – RESRDY: Result Ready

This flag is cleared by writing a '1' to the flag or by reading the RESULT register.

This flag is set when the conversion result is available, and an interrupt will be generated if INTENCLR/SET.RESRDY=1.

Writing a '0' to this bit has no effect.

Writing a '1' to this bit clears the Result Ready interrupt flag.

### 38.8.8 Sequence Status

**Name:** SEQSTATUS

**Offset:** 0x07 [ID-0000120e]

**Reset:** 0x00

**Property:** -

	7	6	5	4	3	2	1	0
Bit	SEQBUSY							SEQSTATE[4:0]
Access	R			R	R	R	R	R
Reset	0			0	0	0	0	0

## Bit 7 – SEQBUSY: Sequence busy

This bit is set when the sequence start.

This bit is clear when the last conversion in a sequence is done.

## Bits 4:0 – SEQSTATE[4:0]: Sequence State

These bit fields are the pointer of sequence. This value identifies the last conversion done in the sequence.

### 38.8.9 Input Control

**Name:** INPUTCTRL

**Offset:** 0x08 [ID-0000120e]

**Reset:** 0x0000

**Property:** PAC Write-Protection, Write-Synchronized

	Bit	15	14	13	12	11	10	9	8
					MUXNEG[4:0]				
Access					R/W	R/W	R/W	R/W	R/W
Reset					0	0	0	0	0
	Bit	7	6	5	4	3	2	1	0
					MUXPOS[4:0]				
Access					R/W	R/W	R/W	R/W	R/W
Reset					0	0	0	0	0

### Bits 12:8 – MUXNEG[4:0]: Negative MUX Input Selection

These bits define the MUX selection for the negative ADC input.

Value	Name	Description
0x00	AIN0	ADC AIN0 pin
0x01	AIN1	ADC AIN1 pin
0x02	AIN2	ADC AIN2 pin
0x03	AIN3	ADC AIN3 pin
0x04	AIN4	ADC AIN4 pin
0x05	AIN5	ADC AIN5 pin
0x06 - 0x17	-	Reserved
0x18	GND	Internal ground
0x19 - 0x1F	-	Reserved

### Bits 4:0 – MUXPOS[4:0]: Positive MUX Input Selection

These bits define the MUX selection for the positive ADC input. If the internal bandgap voltage input channel is selected, then the Sampling Time Length bit group in the Sampling Control register must be written with a corresponding value.

Value	Name	Description
0x00	AIN0	ADC AIN0 pin
0x01	AIN1	ADC AIN1 pin
0x02	AIN2	ADC AIN2 pin
0x03	AIN3	ADC AIN3 pin
0x04	AIN4	ADC AIN4 pin
0x05	AIN5	ADC AIN5 pin
0x06	AIN6	ADC AIN6 pin
0x07	AIN7	ADC AIN7 pin
0x08	AIN8	ADC AIN8 pin
0x09	AIN9	ADC AIN9 pin
0x0A	AIN10	ADC AIN10 pin
0x0B	AIN11	ADC AIN11 pin
0xC - 0x17	-	Reserved
0x18	-	Reserved
0x19	BANDGAP	Bandgap Voltage
0x1A	SCALED COREVCC	1/4 Scaled Core Supply
0x1B	SCALED IOVCC	1/4 Scaled I/O Supply

Value	Name	Description
0x1C	-	Reserved
0x1D	-	Reserved
0x1E	-	Reserved
0x1F	-	Reserved

## 38.8.10 Control C

**Name:** CTRLC  
**Offset:** 0x0A [ID-0000120e]  
**Reset:** 0x0000  
**Property:** PAC Write-Protection, Write-Synchronized

Bit	15	14	13	12	11	10	9	8	
							WINMODE[2:0]		
Access							R/W	R/W	R/W
Reset							0	0	0
Bit	7	6	5	4	3	2	1	0	
	R2R	RESSEL[1:0]			CORREN	FREERUN	LEFTADJ	DIFFMODE	
Access	R/W	R/W			R/W	R/W	R/W	R/W	
Reset	0	0			0	0	0	0	

### Bits 10:8 – WINMODE[2:0]: Window Monitor Mode

These bits enable and define the window monitor mode.

Value	Name	Description
0x0	DISABLE	No window mode (default)
0x1	MODE1	RESULT > WINLT
0x2	MODE2	RESULT < WINUT
0x3	MODE3	WINLT < RESULT < WINUT
0x4	MODE4	WINUT < RESULT < WINLT
0x5 - 0x7		Reserved

### Bit 7 – R2R: Rail-to-Rail Operation

Value	Description
0	Disable rail-to-rail operation.
1	Enable rail-to-rail operation to increase the allowable range of the input common mode voltage ( $V_{CMIN}$ ). When R2R is one, a sampling period of four cycles is required. Offset compensation (SAMPCTRL.OFFCOMP) must be written to one when using this period.

### Bits 5:4 – RESSEL[1:0]: Conversion Result Resolution

These bits define whether the ADC completes the conversion 12-, 10- or 8-bit result resolution.

Value	Name	Description
0x0	12BIT	12-bit result
0x1	16BIT	For averaging mode output
0x2	10BIT	10-bit result
0x3	8BIT	8-bit result

## Bit 3 – CORREN: Digital Correction Logic Enabled

Value	Description
0	Disable the digital result correction.
1	Enable the digital result correction. The ADC conversion result in the RESULT register is then corrected for gain and offset based on the values in the GAINCORR and OFFSETCORR registers. Conversion time will be increased by 13 cycles according to the value in the Offset Correction Value bit group in the Offset Correction register.

## Bit 2 – FREERUN: Free Running Mode

Value	Description
0	The ADC run in single conversion mode.
1	The ADC is in free running mode and a new conversion will be initiated when a previous conversion completes.

## Bit 1 – LEFTADJ: Left-Adjusted Result

Value	Description
0	The ADC conversion result is right-adjusted in the RESULT register.
1	The ADC conversion result is left-adjusted in the RESULT register. The high byte of the 12-bit result will be present in the upper part of the result register. Writing this bit to zero (default) will right-adjust the value in the RESULT register.

## Bit 0 – DIFFMODE: Differential Mode

Value	Description
0	The ADC is running in singled-ended mode.
1	The ADC is running in differential mode. In this mode, the voltage difference between the MUXPOS and MUXNEG inputs will be converted by the ADC.

### 38.8.11 Average Control

**Name:** AVGCTRL

**Offset:** 0x0C [ID-0000120e]

**Reset:** 0x00

**Property:** PAC Write-Protection, Write-Synchronized

Bit	7	6	5	4	3	2	1	0
		ADJRES[2:0]			SAMPLENUM[3:0]			
Access		R/W	R/W	R/W	R/W	R/W	R/W	R/W
Reset		0	0	0	0	0	0	0

#### Bits 6:4 – ADJRES[2:0]: Adjusting Result / Division Coefficient

These bits define the division coefficient in  $2^n$  steps.

#### Bits 3:0 – SAMPLENUM[3:0]: Number of Samples to be Collected

These bits define how many samples are added together. The result will be available in the Result register (RESULT). Note: if the result width increases, CTRLC.RESSEL must be changed.

Value	Description
0x0	1 sample
0x1	2 samples
0x2	4 samples
0x3	8 samples
0x4	16 samples
0x5	32 samples
0x6	64 samples
0x7	128 samples
0x8	256 samples
0x9	512 samples
0xA	1024 samples
0xB - 0xF	Reserved

### 38.8.12 Sampling Time Control

**Name:** SAMPCTRL  
**Offset:** 0x0D [ID-0000120e]  
**Reset:** 0x00  
**Property:** PAC Write-Protection, Write-Synchronized

	Bit	7	6	5	4	3	2	1	0
		OFFCOMP		SAMPLEN[5:0]					
Access		R/W		R/W	R/W	R/W	R/W	R/W	R/W
Reset		0		0	0	0	0	0	0

#### Bit 7 – OFFCOMP: Comparator Offset Compensation Enable

Setting this bit enables the offset compensation for each sampling period to ensure low offset and immunity to temperature or voltage drift. This compensation increases the sampling time by three clock cycles.

This bit must be set to zero to validate the SAMPLEN value. It's not possible to use OFFCOMP=1 and SAMPLEN>0.

#### Bits 5:0 – SAMPLEN[5:0]: Sampling Time Length

These bits control the ADC sampling time in number of CLK\_ADC cycles, depending of the prescaler value, thus controlling the ADC input impedance. Sampling time is set according to the equation:

$$\text{Sampling time} = (\text{SAMPLEN} + 1) \cdot (\text{CLK}_{\text{ADC}})$$

### 38.8.13 Window Monitor Lower Threshold

**Name:** WINLT  
**Offset:** 0x0E [ID-0000120e]  
**Reset:** 0x0000  
**Property:** PAC Write-Protection, Write-Synchronized

Bit	15	14	13	12	11	10	9	8
	WINLT[15:8]							
Access	R/W	R/W	R/W	R/W	R/W	R/W	R/W	R/W
Reset	0	0	0	0	0	0	0	0
Bit	7	6	5	4	3	2	1	0
	WINLT[7:0]							
Access	R/W	R/W	R/W	R/W	R/W	R/W	R/W	R/W
Reset	0	0	0	0	0	0	0	0

**Bits 15:0 – WINLT[15:0]: Window Lower Threshold**

If the window monitor is enabled, these bits define the lower threshold value.

### 38.8.14 Window Monitor Upper Threshold

**Name:** WINUT

**Offset:** 0x10 [ID-0000120e]

**Reset:** 0x0000

**Property:** PAV Write-Protection, Write-Synchronized

Bit	15	14	13	12	11	10	9	8
	WINUT[15:8]							
Access	R/W	R/W	R/W	R/W	R/W	R/W	R/W	R/W
Reset	0	0	0	0	0	0	0	0
Bit	7	6	5	4	3	2	1	0
	WINUT[7:0]							
Access	R/W	R/W	R/W	R/W	R/W	R/W	R/W	R/W
Reset	0	0	0	0	0	0	0	0

**Bits 15:0 – WINUT[15:0]: Window Upper Threshold**

If the window monitor is enabled, these bits define the upper threshold value.

### 38.8.15 Gain Correction

**Name:** GAINCORR

**Offset:** 0x12 [ID-0000120e]

**Reset:** 0x0000

**Property:** PAC Write-Protection, Write-Synchronized

Bit	15	14	13	12	11	10	9	8
	GAINCORR[11:8]							
Access					R/W	R/W	R/W	R/W
Reset					0	0	0	0
Bit	7	6	5	4	3	2	1	0
	GAINCORR[7:0]							
Access	R/W	R/W	R/W	R/W	R/W	R/W	R/W	R/W
Reset	0	0	0	0	0	0	0	0

**Bits 11:0 – GAINCORR[11:0]: Gain Correction Value**

If CTRLC.CORREN=1, these bits define how the ADC conversion result is compensated for gain error before being written to the result register. The gain correction is a fractional value, a 1-bit integer plus an 11-bit fraction, and therefore  $\frac{1}{2} \leq \text{GAINCORR} < 2$ . GAINCORR values range from 0.1000000000 to 1.1111111111.

### 38.8.16 Offset Correction

**Name:** OFFSETCORR  
**Offset:** 0x14 [ID-0000120e]  
**Reset:** 0x0000  
**Property:** PAC Write-Protection, Write-Synchronized

Bit	15	14	13	12	11	10	9	8
	OFFSETCORR[11:8]							
Access					R/W	R/W	R/W	R/W
Reset					0	0	0	0
Bit	7	6	5	4	3	2	1	0
	OFFSETCORR[7:0]							
Access	R/W	R/W	R/W	R/W	R/W	R/W	R/W	R/W
Reset	0	0	0	0	0	0	0	0

**Bits 11:0 – OFFSETCORR[11:0]: Offset Correction Value**

If CTRLC.CORREN=1, these bits define how the ADC conversion result is compensated for offset error before being written to the Result register. This OFFSETCORR value is in two's complement format.

### 38.8.17 Software Trigger

**Name:** SWTRIG  
**Offset:** 0x18 [ID-0000120e]  
**Reset:** 0x00  
**Property:** PAC Write-Protection, Write-Synchronized

Bit	7	6	5	4	3	2	1	0
							START	FLUSH
Access							W	W
Reset							0	0

**Bit 1 – START: ADC Start Conversion**

Writing a '1' to this bit will start a conversion or sequence. The bit is cleared by hardware when the conversion has started. Writing a '1' to this bit when it is already set has no effect.

Writing a '0' to this bit will have no effect.

**Bit 0 – FLUSH: ADC Conversion Flush**

Writing a '1' to this bit will flush the ADC pipeline. A flush will restart the ADC clock on the next peripheral clock edge, and all conversions in progress will be aborted and lost. This bit is cleared until the ADC has been flushed.

After the flush, the ADC will resume where it left off; i.e., if a conversion was pending, the ADC will start a new conversion.

Writing this bit to '0' will have no effect.

### 38.8.18 Debug Control

**Name:** DBGCTRL  
**Offset:** 0x1C [ID-0000120e]  
**Reset:** 0x00  
**Property:** PAC Write-Protection

Bit	7	6	5	4	3	2	1	0
								DBGRUN
Access								R/W
Reset								0

**Bit 0 – DBGRUN: Debug Run**

This bit is not reset by a software reset.

This bit controls the functionality when the CPU is halted by an external debugger.

This bit should be written only while a conversion is not ongoing.

Value	Description
0	The ADC is halted when the CPU is halted by an external debugger.
1	The ADC continues normal operation when the CPU is halted by an external debugger.

### 38.8.19 Synchronization Busy

**Name:** SYNCBUSY  
**Offset:** 0x20 [ID-0000120e]  
**Reset:** 0x0000  
**Property:** -



Bit	15	14	13	12	11	10	9	8
						SWTRIG	OFFSETCORR	GAINCORR
Access						R	R	R
Reset						0	0	0
Bit	7	6	5	4	3	2	1	0
	WINUT	WINLT	SAMPCTRL	AVGCTRL	CTRLC	INPUTCTRL	ENABLE	SWRST
Access	R	R	R	R	R	R	R	R
Reset	0	0	0	0	0	0	0	0

**Bit 10 – SWTRIG: Software Trigger Synchronization Busy**

This bit is cleared when the synchronization of SWTRIG register between the clock domains is complete.

This bit is set when the synchronization of SWTRIG register between clock domains is started.

**Bit 9 – OFFSETCORR: Offset Correction Synchronization Busy**

This bit is cleared when the synchronization of OFFSETCORR register between the clock domains is complete.

This bit is set when the synchronization of OFFSETCORR register between clock domains is started.

**Bit 8 – GAINCORR: Gain Correction Synchronization Busy**

This bit is cleared when the synchronization of GAINCORR register between the clock domains is complete.

This bit is set when the synchronization of GAINCORR register between clock domains is started.

**Bit 7 – WINUT: Window Monitor Lower Threshold Synchronization Busy**

This bit is cleared when the synchronization of WINUT register between the clock domains is complete.

This bit is set when the synchronization of WINUT register between clock domains is started.

**Bit 6 – WINLT: Window Monitor Upper Threshold Synchronization Busy**

This bit is cleared when the synchronization of WINLT register between the clock domains is complete.

This bit is set when the synchronization of WINLT register between clock domains is started.

**Bit 5 – SAMPCTRL: Sampling Time Control Synchronization Busy**

This bit is cleared when the synchronization of SAMPCTRL register between the clock domains is complete.

This bit is set when the synchronization of SAMPCTRL register between clock domains is started.

**Bit 4 – AVGCTRL: Average Control Synchronization Busy**

This bit is cleared when the synchronization of AVGCTRL register between the clock domains is complete.

This bit is set when the synchronization of AVGCTRL register between clock domains is started.

**Bit 3 – CTRLC: Control C Synchronization Busy**

This bit is cleared when the synchronization of CTRLC register between the clock domains is complete.

This bit is set when the synchronization of CTRLC register between clock domains is started.

### Bit 2 – INPUTCTRL: Input Control Synchronization Busy

This bit is cleared when the synchronization of INPUTCTRL register between the clock domains is complete.

This bit is set when the synchronization of INPUTCTRL register between clock domains is started.

### Bit 1 – ENABLE: ENABLE Synchronization Busy

This bit is cleared when the synchronization of ENABLE register between the clock domains is complete.

This bit is set when the synchronization of ENABLE register between clock domains is started.

### Bit 0 – SWRST: SWRST Synchronization Busy

This bit is cleared when the synchronization of SWRST register between the clock domains is complete.

This bit is set when the synchronization of SWRST register between clock domains is started

## 38.8.20 Result

**Name:** RESULT

**Offset:** 0x24 [ID-0000120e]

**Reset:** 0x0000

**Property:** -

Bit	15	14	13	12	11	10	9	8
RESULT[15:8]								
Access	R	R	R	R	R	R	R	R
Reset	0	0	0	0	0	0	0	0
Bit	7	6	5	4	3	2	1	0
RESULT[7:0]								
Access	R	R	R	R	R	R	R	R
Reset	0	0	0	0	0	0	0	0

### Bits 15:0 – RESULT[15:0]: Result Conversion Value

These bits will hold up to a 16-bit ADC conversion result, depending on the configuration.

In single conversion mode without averaging, the ADC conversion will produce a 12-bit result, which can be left- or right-shifted, depending on the setting of CTRLC.LEFTADJ.

If the result is left-adjusted (CTRLC.LEFTADJ), the high byte of the result will be in bit position [15:8], while the remaining 4 bits of the result will be placed in bit locations [7:4]. This can be used only if an 8-bit result is needed; i.e., one can read only the high byte of the entire 16-bit register.

If the result is not left-adjusted (CTRLC.LEFTADJ) and no oversampling is used, the result will be available in bit locations [11:0], and the result is then 12 bits long. If oversampling is used, the result will be located in bit locations [15:0], depending on the settings of the Average Control register.

## 38.8.21 Sequence Control

**Name:** SEQCTRL  
**Offset:** 0x28 [ID-0000120e]  
**Reset:** 0x00000000  
**Property:** PAC Write-Protection

Bit	31	30	29	28	27	26	25	24
	SEQENn	SEQENn	SEQENn	SEQENn	SEQENn	SEQENn	SEQENn	SEQENn
Access	R/W	R/W	R/W	R/W	R/W	R/W	R/W	R/W
Reset	0	0	0	0	0	0	0	0
Bit	23	22	21	20	19	18	17	16
	SEQENn	SEQENn	SEQENn	SEQENn	SEQENn	SEQENn	SEQENn	SEQENn
Access	R/W	R/W	R/W	R/W	R/W	R/W	R/W	R/W
Reset	0	0	0	0	0	0	0	0
Bit	15	14	13	12	11	10	9	8
	SEQENn	SEQENn	SEQENn	SEQENn	SEQENn	SEQENn	SEQENn	SEQENn
Access	R/W	R/W	R/W	R/W	R/W	R/W	R/W	R/W
Reset	0	0	0	0	0	0	0	0
Bit	7	6	5	4	3	2	1	0
	SEQENn	SEQENn	SEQENn	SEQENn	SEQENn	SEQENn	SEQENn	SEQENn
Access	R/W	R/W	R/W	R/W	R/W	R/W	R/W	R/W
Reset	0	0	0	0	0	0	0	0

**Bits 31:0 – SEQENn: Enable Positive Input in the Sequence**

For details on available positive mux selection, refer to [INPUTCTRL.MUXENG](#).

The sequence start from the lowest input, and go to the next enabled input automatically when the conversion is done. If no bits are set the sequence is disabled.

Value	Description
0	Disable the positive input mux n selection from the sequence.
1	Enable the positive input mux n selection to the sequence.

### 38.8.22 Calibration

**Name:** CALIB  
**Offset:** 0x2C [ID-0000120e]  
**Reset:** 0x0000  
**Property:** PAC Write-Protection, Enable-Protected

Bit	15	14	13	12	11	10	9	8
						BIASREFBUF[2:0]		
Access						R/W	R/W	R/W
Reset						0	0	0
Bit	7	6	5	4	3	2	1	0
						BIASCOMP[2:0]		
Access						R/W	R/W	R/W
Reset						0	0	0

**Bits 10:8 – BIASREFBUF[2:0]: Bias Reference Buffer Scaling**

This value from production test must be loaded from the NVM software calibration row into the CALIB register by software to achieve the specified accuracy.

The value must be copied only, and must not be changed.

**Bits 2:0 – BIASCOMP[2:0]: Bias Comparator Scaling**

This value from production test must be loaded from the NVM software calibration row into the CALIB register by software to achieve the specified accuracy.

The value must be copied only, and must not be changed

## 39. AC – Analog Comparators

### 39.1 Overview

The Analog Comparator (AC) supports two individual comparators. Each comparator (COMP) compares the voltage levels on two inputs, and provides a digital output based on this comparison. Each comparator may be configured to generate interrupt requests and/or peripheral events upon several different combinations of input change.

Hysteresis can be adjusted to achieve the optimal operation for each application.

The input selection includes four shared analog port pins and several internal signals. Each comparator output state can also be output on a pin for use by external devices.

The comparators are always grouped in pairs on each port. The AC peripheral implements one pair of comparators. These are called Comparator 0 (COMP0) and Comparator 1 (COMP1). They have identical behaviors, but separate control registers. The pair can be set in window mode to compare a signal to a voltage range instead of a single voltage level.

### 39.2 Features

- Two individual comparators
- Hysteresis: On or Off
- Analog comparator outputs available on pins
  - Asynchronous or synchronous
- Flexible input selection:
  - Four pins selectable for positive or negative inputs
  - Ground (for zero crossing)
  - Bandgap reference voltage
  - 64-level programmable VDD scaler per comparator
- Interrupt generation on:
  - Rising or falling edge
  - Toggle
  - End of comparison
- Window function interrupt generation on:
  - Signal above window
  - Signal inside window
  - Signal below window
  - Signal outside window
- Event generation on:
  - Comparator output
  - Window function inside/outside window
- Optional digital filter on comparator output

### 39.3 Block Diagram

Figure 39-1. Analog Comparator Block Diagram



### 39.4 Signal Description

Signal	Description	Type
AIN[3..0]	Analog input	Comparator inputs
CMP[1..0]	Digital output	Comparator outputs

Refer to *I/O Multiplexing and Considerations* for details on the pin mapping for this peripheral. One signal can be mapped on several pins.

#### Related Links

[I/O Multiplexing and Considerations](#)

### 39.5 Product Dependencies

In order to use this peripheral, other parts of the system must be configured correctly, as described below.

#### 39.5.1 I/O Lines

Using the AC's I/O lines requires the I/O pins to be configured. Refer to *PORT - I/O Pin Controller* for details.

#### Related Links

[PORT: IO Pin Controller](#)

## 39.5.2 Power Management

The AC will continue to operate in any sleep mode where the selected source clock is running. The AC's interrupts can be used to wake up the device from sleep modes. Events connected to the event system can trigger other operations in the system without exiting sleep modes.

### Related Links

[PM – Power Manager](#)

## 39.5.3 Clocks

The AC bus clock (CLK\_AC\_APB) can be enabled and disabled in the Power Manager, and the default state of CLK\_AC\_APB can be found in the Peripheral Clock Masking section in the Power Manager description.

A generic clock (GCLK\_AC) is required to clock the AC. This clock must be configured and enabled in the generic clock controller before using the AC. Refer to the Generic Clock Controller chapter for details.

This generic clock is asynchronous to the bus clock (CLK\_AC\_APB). Due to this asynchronicity, writes to certain registers will require synchronization between the clock domains. Refer to [Synchronization](#) for further details.

### Related Links

[PM – Power Manager](#)

## 39.5.4 DMA

Not applicable.

## 39.5.5 Interrupts

The interrupt request lines are connected to the interrupt controller. Using the AC interrupts requires the interrupt controller to be configured first. Refer to *Nested Vector Interrupt Controller* for details.

### Related Links

[Nested Vector Interrupt Controller](#)

## 39.5.6 Events

The events are connected to the Event System. Refer to *EVSYS – Event System* for details on how to configure the Event System.

### Related Links

[EVSYS – Event System](#)

## 39.5.7 Debug Operation

When the CPU is halted in debug mode, the AC will halt normal operation after any on-going comparison is completed. The AC can be forced to continue normal operation during debugging. Refer to [DBGCTRL](#) for details. If the AC is configured in a way that requires it to be periodically serviced by the CPU through interrupts or similar, improper operation or data loss may result during debugging.

## 39.5.8 Register Access Protection

All registers with write-access can be write-protected optionally by the Peripheral Access Controller (PAC), except for the following registers:

- Control B register (CTRLB)
- Interrupt Flag register (INTFLAG)

Optional write-protection by the Peripheral Access Controller (PAC) is denoted by the "PAC Write-Protection" property in each individual register description.

PAC write-protection does not apply to accesses through an external debugger.

## Related Links

[PAC - Peripheral Access Controller](#)

### 39.5.9 Analog Connections

Each comparator has up to four I/O pins that can be used as analog inputs. Each pair of comparators shares the same four pins. These pins must be configured for analog operation before using them as comparator inputs.

Any internal reference source, such as a bandgap voltage reference, must be configured and enabled prior to its use as a comparator input.

## 39.6 Functional Description

### 39.6.1 Principle of Operation

Each comparator has one positive input and one negative input. Each positive input may be chosen from a selection of analog input pins. Each negative input may be chosen from a selection of both analog input pins and internal inputs, such as a bandgap voltage reference.

The digital output from the comparator is '1' when the difference between the positive and the negative input voltage is positive, and '0' otherwise.

The individual comparators can be used independently (normal mode) or paired to form a window comparison (window mode).

### 39.6.2 Basic Operation

#### 39.6.2.1 Initialization

Some registers are enable-protected, meaning they can only be written when the module is disabled.

The following register is enable-protected:

- Event Control register (EVCTRL)

Enable-protection is denoted by the "Enable-Protected" property in each individual register description.

#### 39.6.2.2 Enabling, Disabling and Resetting

The AC is enabled by writing a '1' to the Enable bit in the Control A register (CTRLA.ENABLE). The AC is disabled writing a '0' to CTRLA.ENABLE.

The AC is reset by writing a '1' to the Software Reset bit in the Control A register (CTRLA.SWRST). All registers in the AC will be reset to their initial state, and the AC will be disabled. Refer to *CTRLA* for details.

#### 39.6.2.3 Comparator Configuration

Each individual comparator must be configured by its respective Comparator Control register (COMPCTRLx) before that comparator is enabled. These settings cannot be changed while the comparator is enabled.

- Select the desired measurement mode with COMPCTRLx.SINGLE. See [Starting a Comparison](#) for more details.
- Select the desired hysteresis with COMPCTRLx.HYSTEN. See [Input Hysteresis](#) for more details.
- Select the comparator speed versus power with COMPCTRLx.SPEED. See [Propagation Delay vs. Power Consumption](#) for more details.



- Select the interrupt source with COMPCTRLx.INTSEL.
- Select the positive and negative input sources with the COMPCTRLx.MUXPOS and COMPCTRLx.MUXNEG bits. See [Selecting Comparator Inputs](#) for more details.
- Select the filtering option with COMPCTRLx.FLEN.
- Select standby operation with Run in Standby bit (COMPCTRLx.RUNSTDBY).

The individual comparators are enabled by writing a '1' to the Enable bit in the Comparator x Control registers (COMPCTRLx.ENABLE). The individual comparators are disabled by writing a '0' to COMPCTRLx.ENABLE. Writing a '0' to CTRLA.ENABLE will also disable all the comparators, but will not clear their COMPCTRLx.ENABLE bits.

### 39.6.2.4 Starting a Comparison

Each comparator channel can be in one of two different measurement modes, determined by the Single bit in the Comparator x Control register (COMPCTRLx.SINGLE):

- Continuous measurement
- Single-shot

After being enabled, a start-up delay is required before the result of the comparison is ready. This start-up time is measured automatically to account for environmental changes, such as temperature or voltage supply level, and is specified in *Electrical Characteristics*. During the start-up time, the COMP output is not available.

The comparator can be configured to generate interrupts when the output toggles, when the output changes from '0' to '1' (rising edge), when the output changes from '1' to '0' (falling edge) or at the end of the comparison. An end-of-comparison interrupt can be used with the single-shot mode to chain further events in the system, regardless of the state of the comparator outputs. The interrupt mode is set by the Interrupt Selection bit group in the Comparator Control register (COMPCTRLx.INTSEL). Events are generated using the comparator output state, regardless of whether the interrupt is enabled or not.

#### Related Links

[Electrical Characteristics 85°C \(SAM C20J/G/E\)](#)

#### Continuous Measurement

Continuous measurement is selected by writing COMPCTRLx.SINGLE to zero. In continuous mode, the comparator is continuously enabled and performing comparisons. This ensures that the result of the latest comparison is always available in the Current State bit in the Status A register (STATUSA.STATEx).

After the start-up time has passed, a comparison is done and STATUSA is updated. The Comparator x Ready bit in the Status B register (STATUSB.READYx) is set, and the appropriate peripheral events and interrupts are also generated. New comparisons are performed continuously until the COMPCTRLx.ENABLE bit is written to zero. The start-up time applies only to the first comparison.

In continuous operation, edge detection of the comparator output for interrupts is done by comparing the current and previous sample. The sampling rate is the GCLK\_AC frequency. An example of continuous measurement is shown in the [Figure 39-2](#).

**Figure 39-2. Continuous Measurement Example**



For low-power operation, comparisons can be performed during sleep modes without a clock. The comparator is enabled continuously, and changes of the comparator state are detected asynchronously. When a toggle occurs, the Power Manager will start GCLK\_AC to register the appropriate peripheral events and interrupts. The GCLK\_AC clock is then disabled again automatically, unless configured to wake up the system from sleep.

## Related Links

[Electrical Characteristics 85°C \(SAM C20J/G/E\)](#)

## Single-Shot

Single-shot operation is selected by writing COMPCTRLx.SINGLE to '1'. During single-shot operation, the comparator is normally idle. The user starts a single comparison by writing '1' to the respective Start Comparison bit in the write-only Control B register (CTRLB.STARTx). The comparator is enabled, and after the start-up time has passed, a single comparison is done and STATUSA is updated. Appropriate peripheral events and interrupts are also generated. No new comparisons will be performed.

Writing '1' to CTRLB.STARTx also clears the Comparator x Ready bit in the Status B register (STATUSB.READYx). STATUSB.READYx is set automatically by hardware when the single comparison has completed.

A single-shot measurement can also be triggered by the Event System. Setting the Comparator x Event Input bit in the Event Control Register (EVCTRL.COMPEIx) enables triggering on incoming peripheral events. Each comparator can be triggered independently by separate events. Event-triggered operation is similar to user-triggered operation; the difference is that a peripheral event from another hardware module causes the hardware to automatically start the comparison and clear STATUSB.READYx.

To detect an edge of the comparator output in single-shot operation for the purpose of interrupts, the result of the current measurement is compared with the result of the previous measurement (one sampling period earlier). An example of single-shot operation is shown in [Figure 39-3](#).

**Figure 39-3. Single-Shot Example**



For low-power operation, event-triggered measurements can be performed during sleep modes. When the event occurs, the Power Manager will start GCLK\_AC. The comparator is enabled, and after the startup time has passed, a comparison is done and appropriate peripheral events and interrupts are also generated. The comparator and GCLK\_AC are then disabled again automatically, unless configured to wake up the system from sleep.

## Related Links

[Electrical Characteristics 85°C \(SAM C20J/G/E\)](#)

### 39.6.3 Selecting Comparator Inputs

Each comparator has one positive and one negative input. The positive input is one of the external input pins (AINx). The negative input can be fed either from an external input pin (AINx) or from one of the several internal reference voltage sources common to all comparators. The user selects the input source as follows:

- The positive input is selected by the Positive Input MUX Select bit group in the Comparator Control register (COMPCTRLx.MUXPOS)

- The negative input is selected by the Negative Input MUX Select bit group in the Comparator Control register (COMPCTRLx.MUXNEG)

In the case of using an external I/O pin, the selected pin must be configured for analog use in the PORT Controller by disabling the digital input and output. The switching of the analog input multiplexers is controlled to minimize crosstalk between the channels. The input selection must be changed only while the individual comparator is disabled.

**Note:** For internal use of the comparison results by the CCL, this bit must be 0x1 or 0x2.

## 39.6.4 Window Operation

Each comparator pair can be configured to work together in window mode. In this mode, a voltage range is defined, and the comparators give information about whether an input signal is within this range or not. Window mode is enabled by the Window Enable x bit in the Window Control register (WINCTRL.WENx). Both comparators in a pair must have the same measurement mode setting in their respective Comparator Control Registers (COMPCTRLx.SINGLE).

To physically configure the pair of comparators for window mode, the same I/O pin must be chosen as positive input for each comparator, providing a shared input signal. The negative inputs define the range for the window. In [Figure 39-4](#), COMP0 defines the upper limit and COMP1 defines the lower limit of the window, as shown but the window will also work in the opposite configuration with COMP0 lower and COMP1 higher. The current state of the window function is available in the Window x State bit group of the Status register (STATUS.WSTATEx).

Window mode can be configured to generate interrupts when the input voltage changes to below the window, when the input voltage changes to above the window, when the input voltage changes into the window or when the input voltage changes outside the window. The interrupt selections are set by the Window Interrupt Selection bit field in the Window Control register (WINCTRL.WINTSEL). Events are generated using the inside/outside state of the window, regardless of whether the interrupt is enabled or not. Note that the individual comparator outputs, interrupts and events continue to function normally during window mode.

When the comparators are configured for window mode and single-shot mode, measurements are performed simultaneously on both comparators. Writing '1' to either Start Comparison bit in the Control B register (CTRLB.STARTx) will start a measurement. Likewise either peripheral event can start a measurement.

Figure 39-4. Comparators in Window Mode



39.6.5 VDD Scaler

The VDD scaler generates a reference voltage that is a fraction of the device’s supply voltage, with 64 levels. One independent voltage channel is dedicated for each comparator. The scaler of a comparator is enabled when the Negative Input Mux bit field in the respective Comparator Control register (COMPCTRLx.MUXNEG) is set to 0x5 and the comparator is enabled. The voltage of each channel is selected by the Value bit field in the Scaler x registers (SCALERx.VALUE).

Figure 39-5. VDD Scaler



**39.6.6 Input Hysteresis**

Application software can selectively enable/disable hysteresis for the comparison. Applying hysteresis will help prevent constant toggling of the output, which can be caused by noise when the input signals are close to each other.

Hysteresis is enabled for each comparator individually by the Hysteresis Enable bit in the Comparator x Control register (COMPCTRLx.HYSTEN). Hysteresis is available only in continuous mode (COMPCTRLx.SINGLE=0).

**39.6.7 Propagation Delay vs. Power Consumption**

It is possible to trade off comparison speed for power efficiency to get the shortest possible propagation delay or the lowest power consumption. The speed setting is configured for each comparator individually by the Speed bit group in the Comparator x Control register (COMPCTRLx.SPEED). The Speed bits select the amount of bias current provided to the comparator, and as such will also affect the start-up time.

**39.6.8 Filtering**

The output of the comparators can be filtered digitally to reduce noise. The filtering is determined by the Filter Length bits in the Comparator Control x register (COMPCTRLx.FLEN), and is independent for each comparator. Filtering is selectable from none, 3-bit majority (N=3) or 5-bit majority (N=5) functions. Any change in the comparator output is considered valid only if N/2+1 out of the last N samples agree. The filter sampling rate is the GCLK\_AC frequency.

Note that filtering creates an additional delay of N-1 sampling cycles from when a comparison is started until the comparator output is validated. For continuous mode, the first valid output will occur when the required number of filter samples is taken. Subsequent outputs will be generated every cycle based on the current sample plus the previous N-1 samples, as shown in [Figure 39-6](#). For single-shot mode, the comparison completes after the Nth filter sample, as shown in [Figure 39-7](#).

**Figure 39-6. Continuous Mode Filtering**

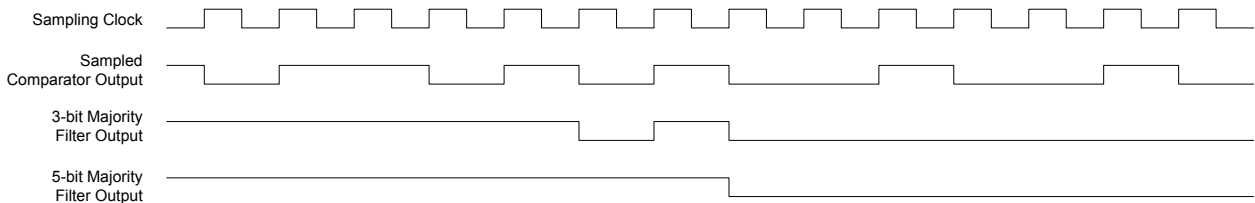

**Figure 39-7. Single-Shot Filtering**

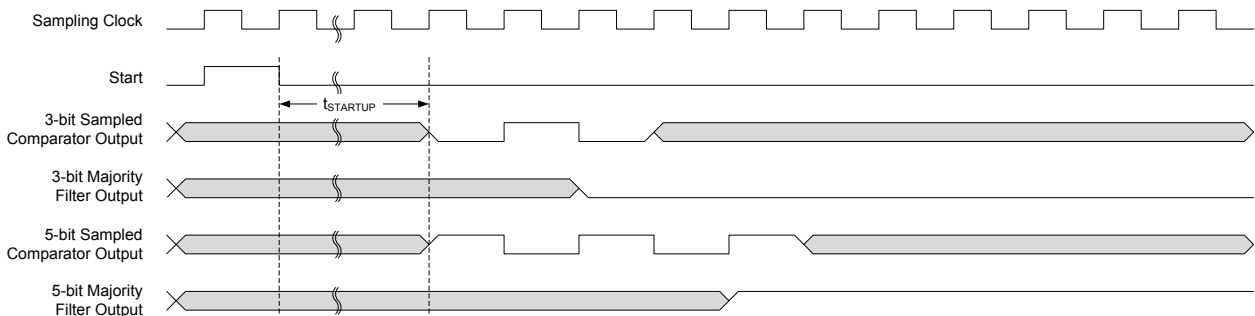

During sleep modes, filtering is supported only for single-shot measurements. Filtering must be disabled if continuous measurements will be done during sleep modes, or the resulting interrupt/event may be generated incorrectly.

## 39.6.9 Comparator Output

The output of each comparator can be routed to an I/O pin by setting the Output bit group in the Comparator Control x register (COMPCTRLx.OUT). This allows the comparator to be used by external circuitry. Either the raw, non-synchronized output of the comparator or the CLK\_AC-synchronized version, including filtering, can be used as the I/O signal source. The output appears on the corresponding CMP[x] pin.

## 39.6.10 Offset Compensation

The Swap bit in the Comparator Control registers (COMPCTRLx.SWAP) controls switching of the input signals to a comparator's positive and negative terminals. When the comparator terminals are swapped, the output signal from the comparator is also inverted, as shown in Figure 39-8. This allows the user to measure or compensate for the comparator input offset voltage. As part of the input selection, COMPCTRLx.SWAP can be changed only while the comparator is disabled.

**Figure 39-8. Input Swapping for Offset Compensation**



## 39.6.11 DMA Operation

Not applicable.

## 39.6.12 Interrupts

The AC has the following interrupt sources:

- Comparator (COMP0, COMP1): Indicates a change in comparator status.
- Window (WIN0): Indicates a change in the window status.

Comparator interrupts are generated based on the conditions selected by the Interrupt Selection bit group in the Comparator Control registers (COMPCTRLx.INTSEL). Window interrupts are generated based on the conditions selected by the Window Interrupt Selection bit group in the Window Control register (WINCTRL.WINTSEL[1:0]).

Each interrupt source has an interrupt flag associated with it. The interrupt flag in the Interrupt Flag Status and Clear (INTFLAG) register is set when the interrupt condition occurs. Each interrupt can be individually enabled by writing a one to the corresponding bit in the Interrupt Enable Set (INTENSET) register, and disabled by writing a one to the corresponding bit in the Interrupt Enable Clear (INTENCLR) register. An interrupt request is generated when the interrupt flag is set and the corresponding interrupt is enabled. The interrupt request remains active until the interrupt flag is cleared, the interrupt is disabled, or the AC is reset. See INFLAG register for details on how to clear interrupt flags. All interrupt requests from the peripheral are ORed together on system level to generate one combined interrupt request to the NVIC. The user must read the INTFLAG register to determine which interrupt condition is present.

Note that interrupts must be globally enabled for interrupt requests to be generated.

### Related Links

### 39.6.13 Events

The AC can generate the following output events:

- Comparator (COMP0, COMP1): Generated as a copy of the comparator status
- Window (WIN0): Generated as a copy of the window inside/outside status

Writing a one to an Event Output bit in the Event Control Register (EVCTRL.xxEO) enables the corresponding output event. Writing a zero to this bit disables the corresponding output event. Refer to the Event System chapter for details on configuring the event system.

The AC can take the following action on an input event:

- Start comparison (START0, START1): Start a comparison.

Writing a one to an Event Input bit into the Event Control register (EVCTRL.COMPEIx) enables the corresponding action on input event. Writing a zero to this bit disables the corresponding action on input event. Note that if several events are connected to the AC, the enabled action will be taken on any of the incoming events. Refer to the Event System chapter for details on configuring the event system.

When EVCTRL.COMPEIx is one, the event will start a comparison on COMPx after the start-up time delay. In normal mode, each comparator responds to its corresponding input event independently. For a pair of comparators in window mode, either comparator event will trigger a comparison on both comparators simultaneously.

### 39.6.14 Sleep Mode Operation

The Run in Standby bits in the Comparator x Control registers (COMPCTRLx.RUNSTDBY) control the behavior of the AC during standby sleep mode. Each RUNSTDBY bit controls one comparator. When the bit is zero, the comparator is disabled during sleep, but maintains its current configuration. When the bit is one, the comparator continues to operate during sleep. Note that when RUNSTDBY is zero, the analog blocks are powered off for the lowest power consumption. This necessitates a start-up time delay when the system returns from sleep.

For Window Mode operation, both comparators in a pair must have the same RUNSTDBY configuration.

When RUNSTDBY is one, any enabled AC interrupt source can wake up the CPU. The AC can also be used during sleep modes where the clock used by the AC is disabled, provided that the AC is still powered (not in shutdown). In this case, the behavior is slightly different and depends on the measurement mode, as listed in [Table 39-1](#).

**Table 39-1. Sleep Mode Operation**

COMPCTRLx.MODE	RUNSTDBY=0	RUNSTDBY=1
0 (Continuous)	COMPx disabled	GCLK_AC stopped, COMPx enabled
1 (Single-shot)	COMPx disabled	GCLK_AC stopped, COMPx enabled only when triggered by an input event

#### 39.6.14.1 Continuous Measurement during Sleep

When a comparator is enabled in continuous measurement mode and GCLK\_AC is disabled during sleep, the comparator will remain continuously enabled and will function asynchronously. The current state of the comparator is asynchronously monitored for changes. If an edge matching the interrupt condition is found, GCLK\_AC is started to register the interrupt condition and generate events. If the interrupt is enabled in the Interrupt Enable registers (INTENCLR/SET), the AC can wake up the device;

otherwise GCLK\_AC is disabled until the next edge detection. Filtering is not possible with this configuration.

**Figure 39-9. Continuous Mode SleepWalking**



### 39.6.14.2 Single-Shot Measurement during Sleep

For low-power operation, event-triggered measurements can be performed during sleep modes. When the event occurs, the Power Manager will start GCLK\_AC. The comparator is enabled, and after the start-up time has passed, a comparison is done, with filtering if desired, and the appropriate peripheral events and interrupts are also generated, as shown in [Figure 39-10](#). The comparator and GCLK\_AC are then disabled again automatically, unless configured to wake the system from sleep. Filtering is allowed with this configuration.

**Figure 39-10. Single-Shot SleepWalking**



### 39.6.15 Synchronization

Due to asynchronicity between the main clock domain and the peripheral clock domains, some registers need to be synchronized when written or read.

The following bits are synchronized when written:

- Software Reset bit in control register (CTRLA.SWRST)
- Enable bit in control register (CTRLA.ENABLE)
- Enable bit in Comparator Control register (COMPCTRLn.ENABLE)

The following registers are synchronized when written:

- Window Control register (WINCTRL)

Required write-synchronization is denoted by the "Write-Synchronized" property in the register description.

#### Related Links

[Register Synchronization](#)



### 39.7 Register Summary

Offset	Name	Bit Pos.								
0x00	CTRLA	7:0							ENABLE	SWRST
0x01	CTRLB	7:0							STARTx	STARTx
0x02	EVCTRL	7:0				WINEO0			COMPEOx	COMPEOx
0x03		15:8			INVEIx	INVEIx			COMPEIx	COMPEIx
0x04	INTENCLR	7:0				WIN0			COMPx	COMPx
0x05	INTENSET	7:0				WIN0			COMPx	COMPx
0x06	INTFLAG	7:0				WIN0			COMPx	COMPx
0x07	STATUSA	7:0				WSTATE0[1:0]			STATEx	STATEx
0x08	STATUSB	7:0							READYx	READYx
0x09	DBGCTRL	7:0								DBGRUN
0x0A	WINCTRL	7:0						WINTSEL0[1:0]		WEN0
0x0B	Reserved									
0x0C	SCALER0	7:0						VALUE[5:0]		
0x0D	SCALER1	7:0						VALUE[5:0]		
0x0E	Reserved									
...										
0x0F										
0x10	COMPCTRL0	7:0		RUNSTDBY		INTSEL[1:0]		SINGLE	ENABLE	
0x11		15:8	SWAP		MUXPOS[2:0]				MUXNEG[2:0]	
0x12		23:16					HYSTEN			SPEED[1:0]
0x13		31:24				OUT[1:0]				FLEN[2:0]
0x14	COMPCTRL1	7:0		RUNSTDBY		INTSEL[1:0]		SINGLE	ENABLE	
0x15		15:8	SWAP		MUXPOS[2:0]				MUXNEG[2:0]	
0x16		23:16					HYSTEN			SPEED[1:0]
0x17		31:24				OUT[1:0]				FLEN[2:0]
0x18	Reserved									
...										
0x1F										
0x20	SYNDBUSY	7:0				COMPCTRLx	COMPCTRLx	WINCTRL	ENABLE	SWRST
0x21		15:8								
0x22		23:16								
0x23		31:24								

### 39.8 Register Description

Registers can be 8, 16, or 32 bits wide. Atomic 8-, 16- and 32-bit accesses are supported. In addition, the 8-bit quarters and 16-bit halves of a 32-bit register, and the 8-bit halves of a 16-bit register can be accessed directly.

Some registers are optionally write-protected by the Peripheral Access Controller (PAC). Optional PAC write-protection is denoted by the "PAC Write-Protection" property in each individual register description. For details, refer to [Register Access Protection](#).

Some registers are synchronized when read and/or written. Synchronization is denoted by the "Write-Synchronized" or the "Read-Synchronized" property in each individual register description. For details, refer to [Synchronization](#).

Some registers are enable-protected, meaning they can only be written when the peripheral is disabled. Enable-protection is denoted by the "Enable-Protected" property in each individual register description.

## 39.8.1 Control A

**Name:** CTRLA  
**Offset:** 0x00 [ID-00000fbb]  
**Reset:** 0x00  
**Property:** PAC Write-Protection, Write-Synchronized

	7	6	5	4	3	2	1	0
							ENABLE	SWRST
Access							R/W	W
Reset							0	0

### Bit 1 – ENABLE: Enable

Due to synchronization, there is delay from updating the register until the peripheral is enabled/disabled. The value written to CTRL.ENABLE will read back immediately and the corresponding bit in the Synchronization Busy register (SYNCBUSY.ENABLE) will be set. SYNCBUSY.ENABLE is cleared when the peripheral is enabled/disabled.

Value	Description
0	The AC is disabled.
1	The AC is enabled. Each comparator must also be enabled individually by the Enable bit in the Comparator Control register (COMPCTRLn.ENABLE).

### Bit 0 – SWRST: Software Reset

Writing a '0' to this bit has no effect.

Writing a '1' to this bit resets all registers in the AC to their initial state, and the AC will be disabled.

Writing a '1' to CTRLA.SWRST will always take precedence, meaning that all other writes in the same write-operation will be discarded.

Due to synchronization, there is a delay from writing CTRLA.SWRST until the reset is complete. CTRLA.SWRST and SYNCBUSY.SWRST will both be cleared when the reset is complete.

Value	Description
0	There is no reset operation ongoing.
1	The reset operation is ongoing.

## 39.8.2 Control B

**Name:** CTRLB  
**Offset:** 0x01 [ID-00000fbb]  
**Reset:** 0x00  
**Property:** PAC Write-Protection, Write-Synchronized

Bit	7	6	5	4	3	2	1	0
							STARTx	STARTx
Access							R/W	R/W
Reset							0	0

### Bits 1,0 – STARTx: Comparator x Start Comparison

Writing a '0' to this field has no effect.

Writing a '1' to STARTx starts a single-shot comparison on COMPx if both the Single-Shot and Enable bits in the Comparator x Control Register are '1' (COMPCTRLx.SINGLE and COMPCTRLx.ENABLE). If comparator x is not implemented, or if it is not enabled in single-shot mode, Writing a '1' has no effect.

This bit always reads as zero.

### 39.8.3 Event Control

**Name:** EVCTRL

**Offset:** 0x02 [ID-00000fbb]

**Reset:** 0x0000

**Property:** PAC Write-Protection, Enable-Protected

Bit	15	14	13	12	11	10	9	8
			INVEIx	INVEIx			COMPEIx	COMPEIx
Access			R/W	R/W			R/W	R/W
Reset			0	0			0	0

Bit	7	6	5	4	3	2	1	0
				WINEO0			COMPEOx	COMPEOx
Access				R/W			R/W	R/W
Reset				0			0	0

### Bits 13,12 – INVEIx: Inverted Event Input Enable x

Value	Description
0	Incoming event is not inverted for comparator x.
1	Incoming event is inverted for comparator x.

### Bits 9,8 – COMPEIx: Comparator x Event Input

Note that several actions can be enabled for incoming events. If several events are connected to the peripheral, the enabled action will be taken for any of the incoming events. There is no way to tell which of the incoming events caused the action.

These bits indicate whether a comparison will start or not on any incoming event.

Value	Description
0	Comparison will not start on any incoming event.
1	Comparison will start on any incoming event.

### Bit 4 – WINEO0: Window 0 Event Output Enable

These bits indicate whether the window 0 function can generate a peripheral event or not.

Value	Description
0	Window 0 Event is disabled.
1	Window 0 Event is enabled.

### Bits 1,0 – COMPEOx: Comparator x Event Output Enable

These bits indicate whether the comparator x output can generate a peripheral event or not.

Value	Description
0	COMPx event generation is disabled.
1	COMPx event generation is enabled.

### 39.8.4 Interrupt Enable Clear

This register allows the user to disable an interrupt without doing a read-modify-write operation. Changes in this register will also be reflected in the Interrupt Enable Set register (INTENSET).

**Name:** INTENCLR  
**Offset:** 0x04 [ID-00000fbb]  
**Reset:** 0x00  
**Property:** PAC Write-Protection

Bit	7	6	5	4	3	2	1	0
				WIN0			COMPx	COMPx
Access				R/W			R/W	R/W
Reset				0			0	0

### Bit 4 – WIN0: Window 0 Interrupt Enable

Reading this bit returns the state of the Window 0 interrupt enable.

Writing a '0' to this bit has no effect.

Writing a '1' to this bit disables the Window 0 interrupt.

Value	Description
0	The Window 0 interrupt is disabled.
1	The Window 0 interrupt is enabled.

### Bits 1,0 – COMPx: Comparator x Interrupt Enable

Reading this bit returns the state of the Comparator x interrupt enable.

Writing a '0' to this bit has no effect.

Writing a '1' to this bit disables the Comparator x interrupt.

Value	Description
0	The Comparator x interrupt is disabled.
1	The Comparator x interrupt is enabled.

### 39.8.5 Interrupt Enable Set

This register allows the user to enable an interrupt without doing a read-modify-write operation. Changes in this register will also be reflected in the Interrupt Enable Clear register (INTENCLR).

**Name:** INTENSET  
**Offset:** 0x05 [ID-00000fbb]  
**Reset:** 0x00  
**Property:** PAC Write-Protection

	Bit	7	6	5	4	3	2	1	0
					WIN0			COMPx	COMPx
Access					R/W			R/W	R/W
Reset					0			0	0

### Bit 4 – WIN0: Window 0 Interrupt Enable

Reading this bit returns the state of the Window 0 interrupt enable.

Writing a '0' to this bit has no effect.

Writing a '1' to this bit enables the Window 0 interrupt.

Value	Description
0	The Window 0 interrupt is disabled.
1	The Window 0 interrupt is enabled.

### Bits 1,0 – COMPx: Comparator x Interrupt Enable

Reading this bit returns the state of the Comparator x interrupt enable.

Writing a '0' to this bit has no effect.

Writing a '1' to this bit will set the Ready interrupt bit and enable the Ready interrupt.

Value	Description
0	The Comparator x interrupt is disabled.
1	The Comparator x interrupt is enabled.

## 39.8.6 Interrupt Flag Status and Clear

**Name:** INTFLAG  
**Offset:** 0x06 [ID-00000fbb]  
**Reset:** 0x00  
**Property:** –

	Bit	7	6	5	4	3	2	1	0
					WIN0			COMPx	COMPx
Access					R/W			R/W	R/W
Reset					0			0	0

### Bit 4 – WIN0: Window 0

This flag is set according to the Window 0 Interrupt Selection bit group in the [WINCTRL](#) register (WINCTRL.WINTSELx) and will generate an interrupt if INTENCLR/SET.WINx is also one.

Writing a '0' to this bit has no effect.

Writing a '1' to this bit clears the Window 0 interrupt flag.

## Bits 1,0 – COMPx: Comparator x

Reading this bit returns the status of the Comparator x interrupt flag. If comparator x is not implemented, COMPx always reads as zero.

This flag is set according to the Interrupt Selection bit group in the Comparator x Control register (COMPCTRLx.INTSEL) and will generate an interrupt if INTENCLR/SET.COMPx is also one.

Writing a '0' to this bit has no effect.

Writing a '1' to this bit clears the Comparator x interrupt flag.

### 39.8.7 Status A

**Name:** STATUSA

**Offset:** 0x07 [ID-00000fbb]

**Reset:** 0x00

**Property:** Read-Only

	Bit	7	6	5	4	3	2	1	0
				WSTATE0[1:0]				STATEx	STATEx
Access				R	R			R	R
Reset				0	0			0	0

## Bits 5:4 – WSTATE0[1:0]: Window 0 Current State

These bits show the current state of the signal if the window 0 mode is enabled.

Value	Name	Description
0x0	ABOVE	Signal is above window
0x1	INSIDE	Signal is inside window
0x2	BELOW	Signal is below window
0x3		Reserved

## Bits 1,0 – STATEx: Comparator x Current State

This bit shows the current state of the output signal from COMPx. STATEx is valid only when STATUSB.READYx is one.

### 39.8.8 Status B

**Name:** STATUSB

**Offset:** 0x08 [ID-00000fbb]

**Reset:** 0x00

**Property:** Read-Only

	Bit	7	6	5	4	3	2	1	0
								READYx	READYx
Access								R	R
Reset								0	0

## Bits 1,0 – READYx: Comparator x Ready

This bit is cleared when the comparator x output is not ready.

This bit is set when the comparator x output is ready.

## 39.8.9 Debug Control

**Name:** DBGCTRL  
**Offset:** 0x09 [ID-0000fbb]  
**Reset:** 0x00  
**Property:** PAC Write-Protection

Bit	7	6	5	4	3	2	1	0
								DBGRUN
Access								R/W
Reset								0

### Bit 0 – DBGRUN: Debug Run

This bit is not reset by a software reset.

This bits controls the functionality when the CPU is halted by an external debugger.

Value	Description
0	The AC is halted when the CPU is halted by an external debugger. Any on-going comparison will complete.
1	The AC continues normal operation when the CPU is halted by an external debugger.

## 39.8.10 Window Control

**Name:** WINCTRL  
**Offset:** 0x0A [ID-0000fbb]  
**Reset:** 0x00  
**Property:** PAC Write-Protection, Write-Synchronized

Bit	7	6	5	4	3	2	1	0
						WINTSELO[1:0]		WEN0
Access						R/W	R/W	R/W
Reset						0	0	0

### Bits 2:1 – WINTSELO[1:0]: Window 0 Interrupt Selection

These bits configure the interrupt mode for the comparator window 0 mode.

Value	Name	Description
0x0	ABOVE	Interrupt on signal above window
0x1	INSIDE	Interrupt on signal inside window
0x2	BELOW	Interrupt on signal below window
0x3	OUTSIDE	Interrupt on signal outside window

### Bit 0 – WEN0: Window 0 Mode Enable

Value	Description
0	Window mode is disabled for comparators 0 and 1.
1	Window mode is enabled for comparators 0 and 1.

## 39.8.11 Scaler n

**Name:** SCALER  
**Offset:** 0x0C + n\*0x01 [n=0..1]  
**Reset:** 0x00  
**Property:** PAC Write-Protection

Bit	7	6	5	4	3	2	1	0
	VALUE[5:0]							
Access			R/W	R/W	R/W	R/W	R/W	R/W
Reset			0	0	0	0	0	0

**Bits 5:0 – VALUE[5:0]: Scaler Value**

These bits define the scaling factor for channel n of the V<sub>DD</sub> voltage scaler. The output voltage, V<sub>SCALE</sub>, is:

$$V_{SCALE} = \frac{V_{DD} \cdot (VALUE + 1)}{64}$$

### 39.8.12 Comparator Control n

**Name:** COMPCTRL  
**Offset:** 0x10 + n\*0x04 [n=0..1]  
**Reset:** 0x00000000  
**Property:** PAC Write-Protection, Write-Synchronized

Bit	31	30	29	28	27	26	25	24
	OUT[1:0]		FLEN[2:0]					
Access			R/W	R/W		R/W	R/W	R/W
Reset			0	0		0	0	0
Bit	23	22	21	20	19	18	17	16
	HYSTEN		SPEED[1:0]					
Access					R/W		R/W	R/W
Reset					0		0	0
Bit	15	14	13	12	11	10	9	8
	SWAP	MUXPOS[2:0]			MUXNEG[2:0]			
Access	R/W	R/W	R/W	R/W		R/W	R/W	R/W
Reset	0	0	0	0		0	0	0
Bit	7	6	5	4	3	2	1	0
	RUNSTDBY	INTSEL[1:0]			SINGLE	ENABLE		
Access		R/W		R/W	R/W	R/W	R/W	
Reset		0		0	0	0	0	

**Bits 29:28 – OUT[1:0]: Output**

These bits configure the output selection for comparator n. COMPCTRLn.OUT can be written only while COMPCTRLn.ENABLE is zero.

**Note:** For internal use of the comparison results by the CCL, this bit must be 0x1 or 0x2.



These bits are not synchronized.

Value	Name	Description
0x0	OFF	The output of COMPn is not routed to the COMPn I/O port
0x1	ASYNCR	The asynchronous output of COMPn is routed to the COMPn I/O port
0x2	SYNCR	The synchronous output (including filtering) of COMPn is routed to the COMPn I/O port
0x3	N/A	Reserved

### Bits 26:24 – FLEN[2:0]: Filter Length

These bits configure the filtering for comparator n. COMPCTRLn.FLEN can only be written while COMPCTRLn.ENABLE is zero.

These bits are not synchronized.

Value	Name	Description
0x0	OFF	No filtering
0x1	MAJ3	3-bit majority function (2 of 3)
0x2	MAJ5	5-bit majority function (3 of 5)
0x3-0x7	N/A	Reserved

### Bit 19 – HYSTEN: Hysteresis Enable

This bit indicates the hysteresis mode of comparator n. Hysteresis is available only for continuous mode (COMPCTRLn.SINGLE=0).

This bit is not synchronized.

Value	Description
0	Hysteresis is disabled.
1	Hysteresis is enabled.

### Bits 17:16 – SPEED[1:0]: Speed Selection

This bit indicates the speed/propagation delay mode of comparator n. COMPCTRLn.SPEED can be written only while COMPCTRLn.ENABLE is zero.

These bits are not synchronized.

Value	Name	Description
0x0	LOW	Low speed
0x1		
0x2		
0x3	HIGH	High speed

### Bit 15 – SWAP: Swap Inputs and Invert

This bit swaps the positive and negative inputs to COMPn and inverts the output. This function can be used for offset cancellation. COMPCTRLn.SWAP can be written only while COMPCTRLn.ENABLE is zero.

These bits are not synchronized.

Value	Description
0	The output of MUXPOS connects to the positive input, and the output of MUXNEG connects to the negative input.
1	The output of MUXNEG connects to the positive input, and the output of MUXPOS connects to the negative input.

### Bits 14:12 – MUXPOS[2:0]: Positive Input Mux Selection

These bits select which input will be connected to the positive input of comparator n. COMPCTRLn.MUXPOS can be written only while COMPCTRLn.ENABLE is zero.

These bits are not synchronized.

Value	Name	Description
0x0	PIN0	I/O pin 0
0x1	PIN1	I/O pin 1
0x2	PIN2	I/O pin 2
0x3	PIN3	I/O pin 3
0x4	VSCALE	VDD scaler
0x5–0x7	-	Reserved

### Bits 10:8 – MUXNEG[2:0]: Negative Input Mux Selection

These bits select which input will be connected to the negative input of comparator n. COMPCTRLn.MUXNEG can only be written while COMPCTRLn.ENABLE is zero.

These bits are not synchronized.

Value	Name	Description
0x0	PIN0	I/O pin 0
0x1	PIN1	I/O pin 1
0x2	PIN2	I/O pin 2
0x3	PIN3	I/O pin 3
0x4	GND	Ground
0x5	VSCALE	VDD scaler
0x6	BANDGAP	Internal bandgap voltage
0x7	-	Reserved

### Bit 6 – RUNSTDBY: Run in Standby

This bit controls the behavior of the comparator during standby sleep mode.

This bit is not synchronized

Value	Description
0	The comparator is disabled during sleep.
1	The comparator continues to operate during sleep.

### Bits 4:3 – INTSEL[1:0]: Interrupt Selection

These bits select the condition for comparator n to generate an interrupt or event. COMPCTRLn.INTSEL can be written only while COMPCTRLn.ENABLE is zero.

These bits are not synchronized.

Value	Name	Description
0x0	TOGGLE	Interrupt on comparator output toggle
0x1	RISING	Interrupt on comparator output rising

Value	Name	Description
0x2	FALLING	Interrupt on comparator output falling
0x3	EOC	Interrupt on end of comparison (single-shot mode only)

### Bit 2 – SINGLE: Single-Shot Mode

This bit determines the operation of comparator n. COMPCTRLn.SINGLE can be written only while COMPCTRLn.ENABLE is zero.

These bits are not synchronized.

Value	Description
0	Comparator n operates in continuous measurement mode.
1	Comparator n operates in single-shot mode.

### Bit 1 – ENABLE: Enable

Writing a zero to this bit disables comparator n.

Writing a one to this bit enables comparator n.

Due to synchronization, there is delay from updating the register until the comparator is enabled/disabled.

The value written to COMPCTRLn.ENABLE will read back immediately after being written.

SYNCBUSY.COMPCTRLn is set. SYNCBUSY.COMPCTRLn is cleared when the peripheral is enabled/disabled.

Writing a one to COMPCTRLn.ENABLE will prevent further changes to the other bits in COMPCTRLn.

These bits remain protected until COMPCTRLn.ENABLE is written to zero and the write is synchronized.

### 39.8.13 Synchronization Busy

**Name:** SYNCBUSY

**Offset:** 0x20 [ID-00000fbb]

**Reset:** 0x00000000

**Property:** Read-Only

	Bit	31	30	29	28	27	26	25	24
Access									
Reset									
	Bit	23	22	21	20	19	18	17	16
Access									
Reset									
	Bit	15	14	13	12	11	10	9	8
Access									
Reset									
	Bit	7	6	5	4	3	2	1	0
Access				R		R	R	R	R
Reset				0		0	0	0	0

**Bits 4,3 – COMPCTRLx: COMPCTRLx Synchronization Busy**

This bit is cleared when the synchronization of the COMPCTRLx register between the clock domains is complete.

This bit is set when the synchronization of the COMPCTRLx register between clock domains is started.

**Bit 2 – WINCTRL: WINCTRL Synchronization Busy**

This bit is cleared when the synchronization of the WINCTRL register between the clock domains is complete.

This bit is set when the synchronization of the WINCTRL register between clock domains is started.

**Bit 1 – ENABLE: Enable Synchronization Busy**

This bit is cleared when the synchronization of the CTRLA.ENABLE bit between the clock domains is complete.

This bit is set when the synchronization of the CTRLA.ENABLE bit between clock domains is started.

**Bit 0 – SWRST: Software Reset Synchronization Busy**

This bit is cleared when the synchronization of the CTRLA.SWRST bit between the clock domains is complete.

This bit is set when the synchronization of the CTRLA.SWRST bit between clock domains is started.

## 40. PTC - Peripheral Touch Controller

### 40.1 Overview

The Peripheral Touch Controller (PTC) acquires signals in order to detect touch on capacitive sensors. The external capacitive touch sensor is typically formed on a PCB, and the sensor electrodes are connected to the analog front end of the PTC through the I/O pins in the device. The PTC supports both self- and mutual-capacitance sensors.

In mutual-capacitance mode, sensing is done using capacitive touch matrices in various X-Y configurations, including indium tin oxide (ITO) sensor grids. The PTC requires one pin per X-line and one pin per Y-line.

In self-capacitance mode, the PTC requires only one pin (Y-line) for each touch sensor.

The number of available pins and the assignment of X- and Y-lines is depending on both package type and device configuration. Refer to the Configuration Summary and I/O Multiplexing table for details.

#### Related Links

[Configuration Summary](#)

[I/O Multiplexing and Considerations](#)

### 40.2 Features

- Low-power, high-sensitivity, environmentally robust capacitive touch buttons, sliders, wheels
- Supports wake-up on touch from standby sleep mode
- Supports mutual capacitance and self-capacitance sensing
  - Mix-and-match mutual-and self-capacitance sensors
- One pin per electrode – no external components
- Load compensating charge sensing
  - Parasitic capacitance compensation and adjustable gain for superior sensitivity
- Zero drift over the temperature and  $V_{DD}$  range
  - Auto calibration and re-calibration of sensors
- Single-shot charge measurement
- Hardware noise filtering and noise signal de-synchronization for high conducted immunity
- Selectable channel change delay allows choosing the settling time on a new channel, as required
- Acquisition-start triggered by command or through auto-triggering feature
- Low CPU utilization through interrupt on acquisition-complete
- Supported by the QTouch<sup>®</sup> Composer development tools. See also [Atmel|START](#) and Atmel Studio documentation.

#### Related Links

[Configuration Summary](#)

[I/O Multiplexing and Considerations](#)

### 40.3 Block Diagram

Figure 40-1. PTC Block Diagram Mutual-Capacitance



Figure 40-2. PTC Block Diagram Self-Capacitance

### 40.4 Signal Description

Table 40-1. Signal Description for PTC

Name	Type	Description
Y[m:0]	Analog	Y-line (Input/Output)
X[n:0]	Digital	X-line (Output)

**Note:** The number of X and Y lines are device dependent. Refer to *Configuration Summary* for details.

Refer to *I/O Multiplexing and Considerations* for details on the pin mapping for this peripheral. One signal can be mapped on several pins.

**Related Links**

[Configuration Summary](#)

[I/O Multiplexing and Considerations](#)

### 40.5 Product Dependencies

In order to use this Peripheral, configure the other components of the system as described in the following sections.

## 40.5.1 I/O Lines

The I/O lines used for analog X-lines and Y-lines must be connected to external capacitive touch sensor electrodes. External components are not required for normal operation. However, to improve the EMC performance, a series resistor of 1kΩ or more can be used on X-lines and Y-lines.

### 40.5.1.1 Mutual-Capacitance Sensor Arrangement

A mutual-capacitance sensor is formed between two I/O lines - an X electrode for transmitting and Y electrode for sensing. The mutual capacitance between the X and Y electrode is measured by the Peripheral Touch Controller.

**Figure 40-3. Mutual Capacitance Sensor Arrangement**



### 40.5.1.2 Self-Capacitance Sensor Arrangement

A self-capacitance sensor is connected to a single pin on the Peripheral Touch Controller through the Y electrode for sensing the signal. The sense electrode capacitance is measured by the Peripheral Touch Controller.

Figure 40-4. Self-capacitance Sensor Arrangement



For more information about designing the touch sensor, refer to [Buttons, Sliders and Wheels Touch Sensor Design Guide](#).

#### 40.5.2 Clocks

The PTC is clocked by the GCLK\_PTC clock. The PTC operates from an asynchronous clock source and the operation is independent of the main system clock and its derivative clocks, such as the peripheral bus clock (CLK\_APB). A number of clock sources can be selected as the source for the asynchronous GCLK\_PTC. The clock source is selected by configuring the Generic Clock Selection ID in the Generic Clock Control register. For more information about selecting the clock sources, refer to *GCLK - Generic Clock Controller*.

The selected clock must be enabled in the Power Manager, before it can be used by the PTC. By default these clocks are disabled. The frequency range of GCLK\_PTC is 400kHz to 4MHz.

#### Related Links

- [GCLK - Generic Clock Controller](#)
- [PM – Power Manager](#)

## 40.6 Functional Description

In order to access the PTC, the user must use the QTouch Composer tool to configure and link the QTouch Library firmware with the application software. QTouch Library can be used to implement buttons, sliders, wheels in a variety of combinations on a single interface.

Figure 40-5. QTouch Library Usage





For more information about QTouch Library, refer to the [QTouch Library Peripheral Touch Controller User Guide](#).

## 41. FREQM – Frequency Meter

### 41.1 Overview

The Frequency Meter (FREQM) can be used to accurately measure the frequency of a clock by comparing it to a known reference clock.

### 41.2 Features

- Ratio can be measured with 24-bit accuracy
- Accurately measures a clock frequency
- Reference clock can be selected from available GCLK\_FREQM\_REF sources
- Measured clock can be selected from available GCLK\_FREQM\_MSR sources

### 41.3 Block Diagram

Figure 41-1. FREQM Block Diagram



### 41.4 Signal Description

Not applicable.

### 41.5 Product Dependencies

In order to use this peripheral, other parts of the system must be configured correctly, as described below.

## 41.5.1 I/O Lines

Not applicable.

## 41.5.2 Power Management

The FREQM will continue to operate in idle sleep mode where the selected source clock is running. The FREQM's interrupts can be used to wake up the device from idle sleep mode. Refer to the Power Manager chapter for details on the different sleep modes.

### Related Links

[PM – Power Manager](#)

## 41.5.3 Clocks

The clock for the FREQM bus interface (CLK\_APB\_FREQM) is enabled and disabled by the Main Clock Controller, the default state of CLK\_APB\_FREQM can be found in the Peripheral Clock Masking section.

Two generic clocks are used by the FREQM: Reference Clock (GCLK\_FREQM\_REF) and Measurement Clock (GCLK\_FREQM\_MSR).

GCLK\_FREQM\_REF is required to clock the internal reference timer, which acts as the frequency reference.

GCLK\_FREQM\_MSR is required to clock a ripple counter for frequency measurement. These clocks must be configured and enabled in the generic clock controller before using the FREQM.

### Related Links

[MCLK – Main Clock](#)

[Peripheral Clock Masking](#)

[GCLK - Generic Clock Controller](#)

## 41.5.4 DMA

Not applicable.

## 41.5.5 Interrupts

The interrupt request line is connected to the interrupt controller. Using FREQM interrupt requires the interrupt controller to be configured first.

### Related Links

[Nested Vector Interrupt Controller](#)

## 41.5.6 Events

Not applicable

## 41.5.7 Debug Operation

When the CPU is halted in debug mode the FREQM continues its normal operation. The FREQM cannot be halted when the CPU is halted in debug mode. If the FREQM is configured in a way that requires it to be periodically serviced by the CPU, improper operation or data loss may result during debugging.

## 41.5.8 Register Access Protection

All registers with write-access can be write-protected optionally by the Peripheral Access Controller (PAC), except the following registers:

- Control B register (CTRLB)
- Interrupt Flag Status and Clear register (INTFLAG)

- Status register (STATUS)

Optional write-protection by the Peripheral Access Controller (PAC) is denoted by the "PAC Write-Protection" property in each individual register description.

Write-protection does not apply to accesses through an external debugger.

#### Related Links

[PAC - Peripheral Access Controller](#)

## 41.6 Functional Description

### 41.6.1 Principle of Operation

FREQM counts the number of periods of the measured clock (GCLK\_FREQM\_MSR) with respect to the reference clock (GCLK\_FREQM\_REF). The measurement is done for a period of  $\text{REFNUM}/f_{\text{CLK\_REF}}$  and stored in the Value register (VALUE.VALUE). REFNUM is the number of Reference clock cycles selected in the Configuration A register (CFGA.REFNUM).

The frequency of the measured clock,  $f_{\text{CLK\_MSR}}$ , is calculated by

$$f_{\text{CLK\_MSR}} = \left( \frac{\text{VALUE}}{\text{REFNUM}} \right) f_{\text{CLK\_REF}}$$

### 41.6.2 Basic Operation

#### 41.6.2.1 Initialization

Before enabling FREQM, the device and peripheral must be configured:

- Each of the generic clocks (GCLK\_FREQM\_REF and GCLK\_FREQM\_MSR) must be configured and enabled.
- 



**Important:** The reference clock must be slower than the measurement clock.

- Write the number of Reference clock cycles for which the measurement is to be done in the Configuration A register (CFGA.REFNUM). This must be a non-zero number.

The following register is enable-protected, meaning that it can only be written when the FREQM is disabled (CTRLA.ENABLE=0):

- Configuration A register (CFGA)

Enable-protection is denoted by the "Enable-Protected" property in the register description.

#### Related Links

[GCLK - Generic Clock Controller](#)

#### 41.6.2.2 Enabling, Disabling and Resetting

The FREQM is enabled by writing a '1' to the Enable bit in the Control A register (CTRLA.ENABLE). The peripheral is disabled by writing CTRLA.ENABLE=0.

The FREQM is reset by writing a '1' to the Software Reset bit in the Control A register (CTRLA.SWRST). On software reset, all registers in the FREQM will be reset to their initial state, and the FREQM will be disabled.

Then ENABLE and SWRST bits are write-synchronized.

## Related Links

[Synchronization](#)

### 41.6.2.3 Measurement

In the Configuration A register, the Number of Reference Clock Cycles field ([CFGA.REFNUM](#)) selects the duration of the measurement. The measurement is given in number of GCLK\_FREQM\_REF periods.

**Note:** The REFNUM field must be written before the FREQM is enabled.

After the FREQM is enabled, writing a '1' to the START bit in the Control B register ([CTRLB.START](#)) starts the measurement. The BUSY bit in Status register ([STATUS.BUSY](#)) is set when the measurement starts, and cleared when the measurement is complete.

There is also an interrupt request for Measurement Done: When the Measurement Done bit in Interrupt Enable Set register ([INTENSET.DONE](#)) is '1' and a measurement is finished, the Measurement Done bit in the Interrupt Flag Status and Clear register ([INTFLAG.DONE](#)) will be set and an interrupt request is generated.

The result of the measurement can be read from the Value register ([VALUE.VALUE](#)). The frequency of the measured clock GCLK\_FREQM\_MSR is then:

$$f_{\text{CLK\_MSR}} = \left( \frac{\text{VALUE}}{\text{REFNUM}} \right) f_{\text{CLK\_REF}}$$

**Note:** In order to make sure the measurement result ([VALUE.VALUE\[23:0\]](#)) is valid, the overflow status ([STATUS.OVF](#)) should be checked.

In case an overflow condition occurred, indicated by the Overflow bit in the STATUS register ([STATUS.OVF](#)), either the number of reference clock cycles must be reduced ([CFGA.REFNUM](#)), or a faster reference clock must be configured. Once the configuration is adjusted, clear the overflow status by writing a '1' to [STATUS.OVF](#). Then another measurement can be started by writing a '1' to [CTRLB.START](#).

### 41.6.3 DMA Operation

Not applicable.

### 41.6.4 Interrupts

The FREQM has one interrupt source:

- DONE: A frequency measurement is done.

The interrupt flag in the Interrupt Flag Status and Clear ([INTFLAG](#)) register is set when the interrupt condition occurs. The interrupt can be enabled by writing a '1' to the corresponding bit in the Interrupt Enable Set ([INTENSET](#)) register, and disabled by writing a '1' to the corresponding bit in the Interrupt Enable Clear ([INTENCLR](#)) register.

An interrupt request is generated when the interrupt flag is set and the corresponding interrupt is enabled. The interrupt request remains active until the interrupt flag is cleared, the interrupt is disabled, or the FREQM is reset. See [INTFLAG](#) for details on how to clear interrupt flags. All interrupt requests from the peripheral are ORed together on system level to generate one combined interrupt request to the NVIC. The user must read the [INTFLAG](#) register to determine which interrupt condition is present.

This interrupt is a synchronous wake-up source.

Note that interrupts must be globally enabled for interrupt requests to be generated.

### 41.6.5 Events

Not applicable.

## 41.6.6 Sleep Mode Operation

The FREQM will continue to operate in idle sleep mode where the selected source clock is running. The FREQM's interrupts can be used to wake up the device from idle sleep mode.

For lowest chip power consumption in sleep modes, FREQM should be disabled before entering a sleep mode.

### Related Links

[PM – Power Manager](#)

## 41.6.7 Synchronization

Due to asynchronicity between the main clock domain and the peripheral clock domains, some registers need to be synchronized when written or read.

The following bits and registers are write-synchronized:

- Software Reset bit in Control A register (CTRLA.SWRST)
- Enable bit in Control A register (CTRLA.ENABLE)

Required write-synchronization is denoted by the "Write-Synchronized" property in the register description.

### Related Links

[Register Synchronization](#)

## 41.7 Register Summary

Offset	Name	Bit Pos.								
0x00	CTRLA	7:0							ENABLE	SWRST
0x01	CTRLB	7:0								START
0x02	CFGA	7:0	REFNUM[7:0]							
0x03		15:8								
0x04	Reserved									
...										
0x07										
0x08		INTENCLR	7:0							
0x09	INTENSET	7:0								DONE
0x0A	INTFLAG	7:0								DONE
0x0B	STATUS	7:0							OVF	BUSY
0x0C	SYNDBUSY	7:0							ENABLE	SWRST
0x0D		15:8								
0x0E		23:16								
0x0F		31:24								
0x10	VALUE	7:0	VALUE[7:0]							
0x11		15:8	VALUE[15:8]							
0x12		23:16	VALUE[23:16]							
0x13		31:24								

## 41.8 Register Description

Registers can be 8, 16, or 32 bits wide. Atomic 8-, 16-, and 32-bit accesses are supported. In addition, the 8-bit quarters and 16-bit halves of a 32-bit register, and the 8-bit halves of a 16-bit register can be accessed directly.

Some registers require synchronization when read and/or written. Synchronization is denoted by the "Read-Synchronized" and/or "Write-Synchronized" property in each individual register description.

Some registers are enable-protected, meaning they can only be written when the module is disabled. Enable-protection is denoted by the "Enable-Protected" property in each individual register description.

Some registers are optionally write-protected by the Peripheral Access Controller (PAC). Optional PAC write-protection is denoted by the "PAC Write-Protection" property in each individual register description.

### 41.8.1 Control A

**Name:** CTRLA

**Offset:** 0x00 [ID-00000e03]

**Reset:** 0x00

**Property:** PAC Write-Protection, Write-Synchronized, Read-Synchronized

Bit	7	6	5	4	3	2	1	0
							ENABLE	SWRST
Access							R/W	R/W
Reset							0	0

**Bit 1 – ENABLE: Enable**

Due to synchronization there is delay from writing CTRLA.ENABLE until the peripheral is enabled/disabled. The value written to CTRLA.ENABLE will read back immediately and the ENABLE bit in the Synchronization Busy register (SYNCBUSY.ENABLE) will be set. SYNCBUSY.ENABLE will be cleared when the operation is complete.

This bit is not enable-protected.

Value	Description
0	The peripheral is disabled.
1	The peripheral is enabled.

**Bit 0 – SWRST: Software Reset**

Writing a '0' to this bit has no effect.

Writing a '1' to this bit resets all registers in the FREQM to their initial state, and the FREQM will be disabled. Writing a '1' to this bit will always take precedence, meaning that all other writes in the same write-operation will be discarded.

Due to synchronization there is a delay from writing CTRLA.SWRST until the Reset is complete. CTRLA.SWRST and SYNCBUSY.SWRST will both be cleared when the Reset is complete.

This bit is not enable-protected.

Value	Description
0	There is no ongoing Reset operation.
1	The Reset operation is ongoing.

## 41.8.2 Control B

**Name:** CTRLB  
**Offset:** 0x01 [ID-00000e03]  
**Reset:** 0x00  
**Property:** –

Bit	7	6	5	4	3	2	1	0
								START
Access								W
Reset								0

**Bit 0 – START: Start Measurement**

Value	Description
0	Writing a '0' has no effect.
1	Writing a '1' starts a measurement.

## 41.8.3 Configuration A



**Name:** CFGA  
**Offset:** 0x02 [ID-00000e03]  
**Reset:** 0x0000  
**Property:** PAC Write-Protection, Enable-protected



**Bits 7:0 – REFNUM[7:0]: Number of Reference Clock Cycles**  
 Selects the duration of a measurement in number of CLK\_FREQM\_REF cycles. This must be a non-zero value, i.e. 0x01 (one cycle) to 0xFF (255 cycles).

#### 41.8.4 Interrupt Enable Clear

**Name:** INTENCLR  
**Offset:** 0x08 [ID-00000e03]  
**Reset:** 0x00  
**Property:** PAC Write-Protection



**Bit 0 – DONE: Measurement Done Interrupt Enable**  
 Writing a '0' to this bit has no effect.  
  
 Writing a '1' to this bit will clear the Measurement Done Interrupt Enable bit, which disables the Measurement Done interrupt.

Value	Description
0	The Measurement Done interrupt is disabled.
1	The Measurement Done interrupt is enabled.

#### 41.8.5 Interrupt Enable Set

**Name:** INTENSET  
**Offset:** 0x09 [ID-00000e03]  
**Reset:** 0x00  
**Property:** PAC Write-Protection

Bit	7	6	5	4	3	2	1	0
								DONE
Access								R/W
Reset								0

**Bit 0 – DONE: Measurement Done Interrupt Enable**

Writing a '0' to this bit has no effect.

Writing a '1' to this bit will set the Measurement Done Interrupt Enable bit, which enables the Measurement Done interrupt.

Value	Description
0	The Measurement Done interrupt is disabled.
1	The Measurement Done interrupt is enabled.

### 41.8.6 Interrupt Flag Status and Clear

**Name:** INTFLAG  
**Offset:** 0x0A [ID-00000e03]  
**Reset:** 0x00  
**Property:** –

Bit	7	6	5	4	3	2	1	0
								DONE
Access								R/W
Reset								0

**Bit 0 – DONE: Measurement Done**

This flag is cleared by writing a '1' to it.

This flag is set when the STATUS.BUSY bit has a one-to-zero transition.

Writing a '0' to this bit has no effect.

Writing a '1' to this bit will clear the DONE interrupt flag.

### 41.8.7 Status

**Name:** STATUS  
**Offset:** 0x0B [ID-00000e03]  
**Reset:** 0x00  
**Property:** –

Bit	7	6	5	4	3	2	1	0
							OVF	BUSY
Access							R/W	R
Reset							0	0

**Bit 1 – OVF: Sticky Count Value Overflow**

This bit is cleared by writing a '1' to it.

This bit is set when an overflow condition occurs to the value counter.

Writing a '0' to this bit has no effect.

Writing a '1' to this bit will clear the OVF status.

**Bit 0 – BUSY: FREQM Status**

Value	Description
0	No ongoing frequency measurement.
1	Frequency measurement is ongoing.

**41.8.8 Synchronization Busy**

**Name:** SYNCBUSY  
**Offset:** 0x0C [ID-00000e03]  
**Reset:** 0x00000000  
**Property:** –



**Bit 1 – ENABLE: Enable**

This bit is cleared when the synchronization of CTRLA.ENABLE is complete.

This bit is set when the synchronization of CTRLA.ENABLE is started.

**Bit 0 – SWRST: Synchronization Busy**

This bit is cleared when the synchronization of CTRLA.SWRST is complete.

This bit is set when the synchronization of CTRLA.SWRST is started.

**41.8.9 Value**

**Name:** VALUE  
**Offset:** 0x10 [ID-00000e03]  
**Reset:** 0x00000000  
**Property:** –

Bit	31	30	29	28	27	26	25	24
Access								
Reset								
Bit	23	22	21	20	19	18	17	16
	VALUE[23:16]							
Access	R	R	R	R	R	R	R	R
Reset	0	0	0	0	0	0	0	0
Bit	15	14	13	12	11	10	9	8
	VALUE[15:8]							
Access	R	R	R	R	R	R	R	R
Reset	0	0	0	0	0	0	0	0
Bit	7	6	5	4	3	2	1	0
	VALUE[7:0]							
Access	R	R	R	R	R	R	R	R
Reset	0	0	0	0	0	0	0	0

**Bits 23:0 – VALUE[23:0]: Measurement Value**

Result from measurement.

## 42. Electrical Characteristics 85°C (SAM C20J/G/E)

### Related Links

[Electrical Characteristics 105°C \(SAM C20J/G/E\)](#)

### 42.1 Disclaimer

All typical values are measured at  $T_a = 25^\circ\text{C}$  unless otherwise specified. All minimum and maximum values are valid across operating temperature and voltage unless otherwise specified.

This chapter only contains characteristics specific for SAM C20J/G/E.

### 42.2 Absolute Maximum Ratings

Stresses beyond those listed in the below table may cause permanent damage to the device. This is a stress rating only and functional operation of the device at these or other conditions beyond those indicated in the operational sections of this specification is not implied. Exposure to absolute maximum rating conditions for extended periods may affect device reliability.

**Table 42-1. Absolute maximum ratings**

Symbol	Parameter	Min.	Max.	Units
$V_{DD}$	Power supply voltage	0	6.1	V
$I_{VDD}$	Current into a $V_{DD}$ pin	-	92	mA
$I_{GND}$	Current out of a GND pin	-	130	mA
$V_{PIN}$	Pin voltage with respect to GND and $V_{DD}$	GND-0.6V	$V_{DD} + 0.6V$	V
$T_{STORAGE}$	Storage temperature	-60	150	$^\circ\text{C}$



**Caution:** This device is sensitive to electrostatic discharges (ESD). Improper handling may lead to permanent performance degradation or malfunctioning. Handle the device following best practice ESD protection rules: Be aware that the human body can accumulate charges large enough to impair functionality or destroy the device.



**Caution:** In debugger cold-plugging mode, NVM erase operations are not protected by the BODVDD and BODCORE. NVM erase operation at supply voltages below specified minimum can cause corruption of NVM areas that are mandatory for correct device behavior.

### Related Links

[GPIO Clusters](#)

### 42.3 General Operating Ratings

The device must operate within the ratings listed in the table below in order for all other electrical characteristics and typical characteristics of the device to be valid.

NVM erase operations are not protected by the BODVDD and BODCORE in debugger cold-plugging mode. NVM erase operation at supply voltages below product specification minimum can cause corruption of the calibration and other areas mandatory for a correct product behavior.

**Table 42-2. General operating conditions**

Symbol	Parameter	Min.	Typ.	Max.	Units
V <sub>DDIN</sub>	Power supply voltage	2.7 <sup>(1)</sup>	5.0	5.5	V
V <sub>DDANA</sub>	Analog supply voltage	2.7 <sup>(1)</sup>	5.0	5.5	V
V <sub>DDIO</sub>	IO supply voltage	2.7 <sup>(1)</sup>	5.0	5.5	V
T <sub>A</sub>	Temperature range	-40	25	85	°C
T <sub>J</sub>	Junction temperature	-	-	100	°C

1. With BODVDD disabled. If the BODVDD is enabled, refer to [Table 42-14](#)

**Note:**

The same voltage must be applied to VDDIN and VDDANA. VDDIO should be lower or equal to VDDIN / VDDANA. The common voltage is referred to as VDD in the datasheet.

Some I/O are in the VDDIO cluster, but can be multiplexed as analog outputs (e.g. PTC.X[n] pads). In such a case, VDDANA is used to power the I/O. Using this configuration may result in an electrical conflict if the VDDIO voltage is lower than the VDDIN/VDDANA.

**Related Links**

[Brown Out Detectors Characteristics](#)

## 42.4 Injection Current

Stresses beyond those listed in the table below may cause permanent damage to the device. This is a stress rating only and functional operation of the device at these or other conditions beyond those indicated in the operational sections of this specification is not implied. Exposure to absolute maximum rating conditions for extended periods may affect device reliability.

**Table 42-3. Injection Current<sup>(1)</sup>**

Symbol	Description	min	max	Unit
I <sub>INJ1</sub> <sup>(2)</sup>	IO pin injection current	-1	+1	mA
I <sub>INJ2</sub> <sup>(3)</sup>	IO pin injection current	-15	+15	mA
I <sub>INJtotal</sub>	Sum of IO pins injection current	-45	+45	mA

1. Injecting current may have an effect on the accuracy of the analog blocks.
2. Conditions for V<sub>PIN</sub>: V<sub>PIN</sub><GND-0.6V or 5.5V<V<sub>PIN</sub><=6.1V.

Conditions for VDD 4.9V<VDD<=5.5V.

If V<sub>pin</sub> is lower than GND-0.6V, then a current limiting resistor is required. The negative DC injection current limiting resistor is calculated as  $R = |(GND-0.6V - V_{PIN})/I_{INJ1}|$ . If V<sub>pin</sub> is greater than VDD+0.6V, then a current limiting resistor is required. The positive DC injection current limiting resistor is calculated as  $R = (V_{PIN}-(VDD+0.6))/I_{INJ1}$ .

3. Conditions for V<sub>PIN</sub>: V<sub>PIN</sub><GND-0.6V or V<sub>PIN</sub><=5.5V.

Conditions for VDD:  $VDD \leq 4.9V$ .

If  $V_{pin}$  is lower than  $GND - 0.6V$ , then a current limiting resistor is required. The negative DC injection current limiting resistor is calculated as  $R = |(GND - 0.6V - V_{PIN}) / I_{INJ2}|$ . If  $V_{pin}$  is greater than  $VDD + 0.6V$ , then a current limiting resistor is required. The positive DC injection current limiting resistor is calculated as  $R = (V_{PIN} - (VDD + 0.6)) / I_{INJ2}$ .

## 42.5 Supply Characteristics

The following characteristics are applicable to the operating temperature range:  $T_A = -40^\circ C$  to  $105^\circ C$ , unless otherwise specified and are valid for a junction temperature up to  $T_J = 125^\circ C$ .

**Table 42-4. Supply Characteristics**

Symbol	Conditions	Voltage		
		Min.	Max.	Units
$V_{DDIO}$ $V_{DDIN}$ $V_{DDANA}$	Full Voltage Range	2.7	5.5	V

**Table 42-5. Supply Rise Rates**

Symbol	Parameter	Fall Rate	Rise Rate	Units
		Max	Max.	
$V_{DDIO}$	DC supply peripheral I/Os, internal regulator and analog supply	0.05	0.1	V/ $\mu s$
$V_{DDIN}$		0.05	0.1	
$V_{DDANA}$		0.05	0.1	

**Table 42-6. Power Supply Current Requirement**

Symbol	Conditions	Current	Units
		Max	
$I_{INPUT}^{(1)}$	Power up Maximum current	1.9	mA

- $I_{INPUT}$  is the minimum requirement for the power supply connected to the device.

### Related Links

[Power Supply and Start-Up Considerations](#)

## 42.6 Maximum Clock Frequencies

**Table 42-7. Maximum GCLK Generator Output Frequencies**

Symbol	Condition	Max.	Units
$f_{GCLKGEN0} / f_{GCLK\_MAIN}$	Undivided	96	MHz
$f_{GCLKGEN1}$			
$f_{GCLKGEN2}$			

Symbol	Condition	Max.	Units
$f_{\text{GCLKGEN3}}$	Divided	66	MHz
$f_{\text{GCLKGEN4}}$			
$f_{\text{GCLKGEN5}}$			
$f_{\text{GCLKGEN6}}$			
$f_{\text{GCLKGEN7}}$			
$f_{\text{GCLKGEN8}}$			

**Table 42-8. Maximum Peripheral Clock Frequencies**

Symbol	Description	Max.	Units
$f_{\text{CPU}}$	CPU clock frequency	48	MHz
$f_{\text{AHB}}$	AHB clock frequency	48	MHz
$f_{\text{APBA}}$	APBA clock frequency	48	MHz
$f_{\text{APBB}}$	APBB clock frequency	48	MHz
$f_{\text{APBC}}$	APBC clock frequency	48	MHz
$f_{\text{APBD}}$	APBD clock frequency	48	MHz
$f_{\text{GCLK\_DPLL}}$	FDPLL96M Reference clock frequency	2	MHz
$f_{\text{GCLK\_DPLL\_32K}}$	FDPLL96M 32k Reference clock frequency	32	kHz
$f_{\text{GCLK\_EIC}}$	EIC input clock frequency	48	MHz
$f_{\text{GCLK\_FREQM\_MSR}}$	FREQM Measure	96	MHz
$f_{\text{GCLK\_FREQM\_REF}}$	FREQM Reference	48	MHz
$f_{\text{GCLK\_EVSYS\_CHANNEL\_0}}$	EVSYS channel 0 input clock frequency	48	MHz
$f_{\text{GCLK\_EVSYS\_CHANNEL\_1}}$	EVSYS channel 1 input clock frequency	48	MHz
$f_{\text{GCLK\_EVSYS\_CHANNEL\_2}}$	EVSYS channel 2 input clock frequency	48	MHz
$f_{\text{GCLK\_EVSYS\_CHANNEL\_3}}$	EVSYS channel 3 input clock frequency	48	MHz
$f_{\text{GCLK\_EVSYS\_CHANNEL\_4}}$	EVSYS channel 4 input clock frequency	48	MHz
$f_{\text{GCLK\_EVSYS\_CHANNEL\_5}}$	EVSYS channel 5 input clock frequency	48	MHz
$f_{\text{GCLK\_SERCOMn\_SLOW}}$	Common SERCOM slow input clock frequency	5	MHz
$f_{\text{GCLK\_SERCOMn\_CORE}}$	SERCOM0 input clock frequency	48	MHz
$f_{\text{GCLK\_TCC0, 1}}$	TCCn input clock frequency	92	MHz
$f_{\text{GCLK\_TCC2}}$	TCC2 input clock frequency	48	MHz
$f_{\text{GCLK\_TCn}}$	TCn input clock frequency	48	MHz
$f_{\text{GCLK\_ADC0}}$	ADC0 input clock frequency	48	MHz
$f_{\text{GCLK\_PTC}}$	PTC input clock frequency	48	MHz



Symbol	Description	Max.	Units
$f_{GCLK\_CCL}$	CCL input clock frequency	48	MHz
$f_{GCLK\_AC}$	AC digital input clock frequency	48	MHz

## 42.7 Power Consumption

The values in the Power Consumption table below are measured values of power consumption under the following conditions, except where noted:

- Operating conditions
  - $V_{DDIN} = 3.3V, 5.0V$
- Oscillators
  - XOSC (crystal oscillator) stopped
  - XOSC32K (32 kHz crystal oscillator) running with external 32kHz crystal
  - FDPLL using XOSC32K as reference and running at 48 MHz
- Clocks
  - FDPLL used as main clock source, except otherwise specified
  - CPU, AHB clocks undivided
  - All peripheral clocks stopped
- I/Os are inactive with input trigger disable
- CPU is running on flash with 1 wait state when operating at 5V and 3 wait states at 3V
- NVMCTRL cache enabled
- BODVDD disabled

Mode	conditions	Ta	Vcc	Typ.	Max.	Units
ACTIVE	CPU running a While 1 algorithm	25°C	5.0V	3.8	4.2	mA
		85°C	5.0V	3.9	4.3	
	CPU running a While 1 algorithm	25°C	3.0V	3.7	4.1	mA
		85°C	3.0V	3.9	4.3	
	CPU running a While 1 algorithm, with GCLKIN as reference	25°C	5.0V	$71 * \text{Freq} + 160$	$78 * \text{Freq} + 162$	$\mu\text{A}$ (with freq in MHz)
		85°C	5.0V	$71 * \text{Freq} + 253$	$74 * \text{Freq} + 447$	
	CPU running a Fibonacci algorithm	25°C	5.0V	4.7	5.2	mA
		85°C	5.0V	4.8	5.3	
	CPU running a Fibonacci algorithm	25°C	3.0V	4.7	5.1	mA
		85°C	3.0V	4.8	5.3	
	CPU running a Fibonacci algorithm, with GCLKIN as reference	25°C	5.0V	$90 * \text{Freq} + 163$	$99 * \text{Freq} + 168$	$\mu\text{A}$ (with freq in MHz)
		85°C	5.0V	$90 * \text{Freq} + 258$	$95 * \text{Freq} + 450$	
	CPU running a CoreMark algorithm	25°C	5.0V	5.9	6.4	mA
		85°C	5.0V	6.1	6.6	

Mode	conditions	Ta	Vcc	Typ.	Max.	Units
	CPU running a CoreMark algorithm	25°C	3.0V	5.2	5.7	mA
		85°C	3.0V	5.4	5.8	
	CPU running a CoreMark algorithm, with GCLKIN as reference	25°C	5.0V	115*Freq+167	126*Freq+167	µA (with freq in MHz)
		85°C	5.0V	117*Freq+261	122*Freq+454	
IDLE		25°C	5.0V	1.2	1.3	mA
		85°C	5.0V	1.3	2.3	
STANDBY	XOSC32K running RTC running at 1kHz	25°C	5.0V	15.9	37.0	µA
		85°C	5.0V	89.9	302.0	
	XOSC32K and RTC stopped	25°C	5.0V	14.6	35.0	
		85°C	5.0V	87.8	300.0	

1. These are based on characterization.

## 42.8 Wake-Up Time

Conditions:

- $V_{DD} = 5.0V$
- CPU clock = OSC48M @8Mhz
- 0 Wait-state
- Cache enabled
- Flash in WAKEUPINSTANT mode (NVMCTRL.CTRLB.SLEEPFRM=1)

CPU sets an IO by writing PORT->IOBUS without jumping in an interrupt handler (Cortex M0+ register PRIMASK=1). The wakeup time is measured between the edge of the wakeup input signal and the edge of the GPIO pin.

**Table 42-9. Wake-up Timings**

Sleep Mode	Typ	Unit
IDLE	15.2	µs
STANDBY	48	µs

## 42.9 I/O Pin Characteristics

There are two different pin types with two different speeds: Normal and High Sink<sup>(2)</sup>. The Drive Strength bit is located in the Pin Configuration register PORT (PORT.PINCFG.DRVSTR).

The pins with I<sup>2</sup>C alternative mode available are compliant with I<sup>2</sup>C specifications. All I<sup>2</sup>C pins support Standard (Sm), Fast (Fm), Fast plus (Fm+) and High speed (Hs) modes. The available I<sup>2</sup>C pins are listed in the I/O Multiplexing section.

**Table 42-10. I/O Pins Common Characteristics**

Symbol	Parameter	Conditions	Min.	Typ.	Max.	Units
V <sub>IL</sub>	Input low-level voltage	VDD=2.7-4.5V	-	-	0.3*VDD	V
		VDD=4.5-5.5V	-	-	0.3*VDD	
V <sub>IH</sub>	Input high-level voltage	VDD=2.7-4.5V	0.7*VDD	-	-	
		VDD=4.5-5.5V	0.7*VDD	-	-	
V <sub>OL</sub>	Output low-level voltage	VDD>2.7V, I <sub>OL</sub> max	-	0.1*VDD	0.2*VDD	
V <sub>OH</sub>	Output high-level voltage	VDD>2.7V, I <sub>OH</sub> max	0.8*VDD	0.9*VDD	-	
R <sub>PULL</sub>	Pull-up - Pull-down resistance	All pins	20	40	60	kΩ
I <sub>LEAK</sub>	Input leakage current	Pull-up resistors disabled	-1	-	1	μA

**Table 42-11. I/O Pins Maximum Output Current**

Symbol	Parameter	Conditions	Normal pins	High Sink pins	Normal pins	High Sink pins	Units
			DRVSTR=0		DRVSTR=1		
I <sub>OL</sub>	Maximum output low-level current	VDD=2.7V-4.5V	2.5	5	5	10	mA
		VDD=4.5V-5.5V	5	10	10	20	
I <sub>OH</sub>	Maximum output high-level current	VDD=2.7V-4.5V	1.5	3	3	6	
		VDD=4.5V-5.5V	3	6	6	12	

**Table 42-12. I/O Pins Dynamic Characteristics <sup>(1)</sup>**

Symbol	Parameter	Conditions	Normal pins	High Sink pins	Normal pins	High Sink pins	Units
			DRVSTR=0		DRVSTR=1		
t <sub>RISE</sub>	Maximum rise time	VDD = 5.0V, load = 20pF	15	12	8	7	ns
t <sub>FALL</sub>	Maximum fall time	VDD = 5.0V, load = 20pF	14	11	7	7	

1. These values are based on simulation. These values are not covered by test limits in production or characterization.
2. The following pins are High Sink pins and have different properties than normal pins: PA10, PA11, PB10, PB11.

**Related Links**
[I/O Multiplexing and Considerations](#)
[PINCFG](#)

## 42.10 Analog Characteristics

### 42.10.1 POR - Power On Reset Characteristics

Table 42-13. POR Characteristics

Symbol	Parameters	Min	Typ	Max	Unit
$V_{POT+}$	Voltage threshold Level on Vddin rising	-	2.55	-	V
$V_{POT-}$	Voltage threshold Level on Vddin falling	1.53	1.75	1.97	

Figure 42-1. POR Operating Principle



### 42.10.2 Brown Out Detectors Characteristics

1. See NVM User Row Mapping table for the BODVDD default value settings.
2. These values are based on simulation. These values are not covered by test limits in production or characterization.

Figure 42-2. BODVDD Hysteresis OFF



Figure 42-3. BODVDD Hysteresis ON



**Table 42-14. BODVDD Characteristics<sup>(2)</sup>**

Symbol	Parameters	Conditions	Min	Typ	Max	Unit
VBOD+ <sup>(1)</sup>	BODVDD high threshold Level	VDD level, Bod setting = 8 (default)	-	2.86	-	V
		VDD level, Bod setting = 9	-	2.92	-	
		VDD level, Bod setting = 44	-	4.57	-	
VBOD- / VBOD <sup>(1)</sup>	BODVDD low threshold Level	VDD level, Bod setting = 8 (default)	-	2.8	-	
		VDD level, Bod setting = 9	-	2.85	-	
		VDD level, Bod setting = 44	-	4.51	-	
	Step size		-	60	-	mV
VHys <sup>(1)</sup>	Hysteresis (VBOD+ - VBOD-) BODVDD.LEVEL = 8 to 48	VDD	40	-	75	mV
T <sub>START</sub> <sup>(3)</sup>	Startup time	time from enable to RDY	-	3.1	-	μs

1. These are based on characterization.
2. BODVDD in continuous mode.
3. These are based on simulation. These values are not covered by test or characterization

**Table 42-15. Power Consumption<sup>(1)</sup>**

Symbol	Parameters	Conditions	Ta	Typ.	Max	Units
I <sub>DD</sub>	IDLE, Mode CONT	VDD = 2.7V	Max 85°C	22.5	26.3	μA
		VDD = 5.0V	Typ 25°C	41.0	47.1	
	IDLE, Mode SAMPL	VDD = 2.7V		0.1	1.2	
		VDD = 5.0V		0.1	1.2	
	STANDBY, Mode SAMPL	VDD = 2.7V		0.8	1.6	
		VDD = 5.0V		3.5	4.6	

1. These are based on characterization.

**Related Links**

[NVM User Row Mapping](#)

**42.10.3 Voltage Regulator Characteristics**

**Table 42-16. Voltage Regulator Characteristics**

Symbol	Parameter	Min.	Typ.	Max.	Units
VDDIN	Input voltage range	2.7	-	5.5	V
VDDCORE	DC calibrated output voltage	-	1.23	-	V

**Table 42-17. Decoupling Requirements**

Symbol	Parameter	Conditions	Typ.	Units
C <sub>in</sub>	Input regulator capacitor, between VDDIN and GND		1	μF
		Ceramic dielectric X7R	100	nF
C <sub>out</sub>	Output regulator capacitor, between VDDCORE and GND	ESR Max. = 0.5Ω	1	μF
		Ceramic dielectric X7R	100	nF

## 42.10.4 Analog-to-Digital Converter (ADC) Characteristics

**Table 42-18. Operating Conditions<sup>(1)</sup>**

Symbol	Parameters	Conditions	Min	Typ	Max	Unit
Res	Resolution		-	-	12	bits
Rs	Sampling rate		10	-	1000	ksps
fs	Sampling clock		10	-	1000	kHz
	Differential mode Number of ADC clock cycles SAMPCTRL.OFFCOMP=1	resolution 12 bit (CTRLC.RESSEL=0)	-	16	-	cycles
		resolution 10 bit (CTRLC.RESSEL=2)		14		
		resolution 8 bit (CTRLC.RESSEL=3)		12		
	Differential mode Number of ADC clock cycles SAMPCTRL.OFFCOMP=0 SAMPLEN corresponds to the decimal value of SAMPCTRL.SAMPLEN[5:0] register	resolution 12 bit (CTRLC.RESSEL=0)	-	SAMPLEN +13	-	cycles
		resolution 10 bit (CTRLC.RESSEL=2)		SAMPLEN +11		
		resolution 8 bit (CTRLC.RESSEL=3)		SAMPLEN+9		
	Single-ended mode Number of ADC clock cycles SAMPCTRL.OFFCOMP=1	resolution 12 bit (CTRLC.RESSEL=0)	-	16	-	cycles
		resolution 10 bit (CTRLC.RESSEL=2)		15		
		resolution 8 bit (CTRLC.RESSEL=3)		13		
	Single-ended mode Number of ADC clock cycles SAMPCTRL.OFFCOMP=0 SAMPLEN corresponds to the decimal value of SAMPCTRL.SAMPLEN[5:0] register	resolution 12 bit (CTRLC.RESSEL=0)	-	SAMPLEN +13	-	cycles
		resolution 10 bit (CTRLC.RESSEL=2)		SAMPLEN +12		
		resolution 8 bit (CTRLC.RESSEL=3)		SAMPLEN +10		
fadc	ADC Clock frequency	SAMPCTRL.OFFCOMP=1 or CTRLC.R2R=1	-	fs*16	-	Hz
		SAMPCTRL.OFFCOMP=0	-	fs*13	-	
Ts	Sampling time	SAMPCTRL.OFFCOMP=1 or CTRLC.R2R=1	250	-	25000	ns
		SAMPCTRL.OFFCOMP=0	76	-	7692	

Symbol	Parameters	Conditions	Min	Typ	Max	Unit
	Sampling time with DAC as input	SAMPCTRL.OFFCOMP=1 or CTRLC.R2R=1	3000	-	25000	
		SAMPCTRL.OFFCOMP=0	3000	-	7692	
	Conversion range	Differential mode	-VREF	-	+VREF	V
	Conversion range	Single-ended mode	0	-	VREF	V
Vref	Reference input	REFCTRL.REFCOMP=1	2	-	VDDANA-0.6	V
		REFCTRL.REFCOMP=0	VDDANA	-	VDDANA	
Vin	Input channel range	-	0	-	VDDANA	V
Vcmin	Input common mode voltage	CTRLC.R2R=1	0.2	-	VREF-0.2	V
		CTRLC.R2R=0	VREF/2-0.2	-	VREF/2+0.2	V
CSAMPLE	Input sampling capacitance		-	1.6	4.5	pF
RSAMPLE	Input sampling on-resistance	For a sampling rate at 1 Msps	-	1000	1715	Ω
Rref	Reference input source resistance		0	-	1000	kΩ

1. These values are based on simulation. These values are not covered by test limits in production or characterization.

**Figure 42-4. ADC Analog Input AINx**



The minimum sampling time  $t_{\text{samplehold}}$  for a given  $R_{\text{source}}$  can be found using this formula:

$$t_{\text{samplehold}} \geq (R_{\text{sample}} + R_{\text{source}}) \times C_{\text{sample}} \times (n + 2) \times \ln(2)$$

For 12-bit accuracy:

$$t_{\text{samplehold}} \geq (R_{\text{sample}} + R_{\text{source}}) \times C_{\text{sample}} \times 9.7$$

$$\text{where } t_{\text{samplehold}} \geq \frac{1}{2 \times f_{\text{ADC}}}$$

**Table 42-19. Differential Mode<sup>(1)</sup>**

Symbol	Parameter	Conditions		Measurement			Unit
				Min	Typ	Max	
ENOB <sup>(2)</sup>	Effective Number of bits	Fadc = 500 ksps	Vddana=5.0V Vref=Vddana	10.0	10.7	11	bits
			Vddana=2.7V Vref=2.0V	10.3	10.5	10.9	
		Fadc = 1 Msps	Vddana=5.0V Vref=Vddana	10.5	10.8	11.1	
			Vddana=2.7V Vref=2.0V	9.9	10.0	10.6	
TUE	Total Unadjusted Error	Fadc = 500 ksps	Vddana=5.0V Vref=Vddana	-	7.8	17.0	LSB
			Vddana=2.7V Vref=2.0V	-	8.0	32.0	
		Fadc = 1 Msps	Vddana=5.0V Vref=Vddana	-	9.0	20.0	
			Vddana=2.7V Vref=2.0V	-	10.5	32.0	
INL	Integral Non Linearity	Fadc = 500 ksps	Vddana=5.0V Vref=Vddana	-	+/-1.6	+/-3	LSB
			Vddana=2.7V Vref=2.0V	-	+/-1.9	+/-3	
		Fadc = 1 Msps	Vddana=5.0V Vref=Vddana	-	+/-1.5	+/-3	
			Vddana=2.7V Vref=2.0V	-	+/-3.2	+/-5	
DNL	Differential Non Linearity	Fadc = 500 ksps	Vddana=5.0V Vref=Vddana	-	-0.8/+1	-1/+2	LSB
			Vddana=2.7V Vref=2.0V	-	-0.7/+1.3	-1/+2.1	
		Fadc = 1 Msps	Vddana=5.0V Vref=Vddana	-	-0.8/+1.1	-1/+3.3	
			Vddana=2.7V Vref=2.0V	-	-0.9/+1.3	-1/+3.2	
Gain	Gain Error <sup>(1)</sup>	Fadc = 1 Msps	Vddana=2.7V Vref=2.0V	-	+/-18	+/-57	mV
			Vddana=5.0V Vref=4.096V	-	+/-41	+/-100	



Symbol	Parameter	Conditions	Measurement			Unit	
			Min	Typ	Max		
			Vddana=3.0V Vref=Vddana	-	+/-17	+/-66	
			Vddana=5.0V Vref=Vddana		+/-39	+/-81	
TCg	Gain Drift	Fadc = 1 Msps	Vddana=5.0V Vref=Vddana	-250	-210	-170	μV/°C
Offset	Offset Error <sup>(1)</sup>	Fadc = 1 Msps	Vddana=2.7V Vref=2.0V	-	+/-1.4	+/-11	mV
			Vddana=5.0V Vref=4.096V	-	+/-6	+/-18	
			Vddana=3.0V Vref=Vddana	-	+/-2	+/-9	
			Vddana=5.0V Vref=Vddana		+/-0.2	+/-23	
Tco	Offset Drift	Fadc = 1 Msps	Vddana=5.0V Vref=Vddana	20	80	120	μV/°C
SFDR		Spurious Free Dynamic Range	Fs = 1Msps / Fin = 14 kHz / Full range Input signal Vddana=5.0V Vref=Vddana	71	75	81	dB
SINAD		Signal to Noise and Distortion ratio		65	67	68	
SNR		Signal to Noise ratio		67	68	69	
THD				-77	-74	-70	
		Noise RMS	External Reference voltage	-	0.5	2.0	mV

1. These values are based on characterization. These values are not covered by test limits in production.
2. For best ENOB with external reference, comparator offset cancellation is recommended to be turned off (SAMPCTRL.OFFCOMP=0).

**Table 42-20. Single-Ended Mode<sup>(1)</sup>**

Symbol	Parameter	Conditions		Measurement			Unit
				Min	Typ	Max	
ENOB <sup>(2)</sup>	Effective Number of bits	Fadc = 500 ksps	Vddana=5.0V Vref=Vddana	9.1	9.7	10.0	bits
			Vddana=2.7V Vref=2.0V	9.1	9.4	9.8	
		Fadc = 1 Msps	Vddana=5.0V Vref=Vddana	9.1	9.7	9.9	
			Vddana=2.7V Vref=2.0V	9.0	9.2	9.6	
TUE	Total Unadjusted Error	Fadc = 500 ksps	Vddana=5.0V Vref=Vddana	-	18.0	65.0	LSB
			Vddana=2.7V Vref=2.0V	-	30.2	62.0	
		Fadc = 1 Msps	Vddana=5.0V Vref=Vddana	-	18.4	60.0	
			Vddana=2.7V Vref=2.0V	-	30.4	61.0	
INL	Integral Non Linearity	Fadc = 500 ksps	Vddana=5.0V Vref=Vddana	-	+/-2.4	+/-4	LSB
			Vddana=2.7V Vref=2.0V	-	+/-3.7	+/-6	
		Fadc = 1 Msps	Vddana=5.0V Vref=Vddana	-	+/-2.2	+/-4	
			Vddana=2.7V Vref=2.0V	-	+/-4.1	+/-6	
DNL	Differential Non Linearity	Fadc = 500 ksps	Vddana=5.0V Vref=Vddana	-	-0.8/+1.1	-1/+3.8	LSB
			Vddana=2.7V Vref=2.0V	-	-0.8/+1.1	-1/+1.7	
		Fadc = 1 Msps	Vddana=5.0V Vref=Vddana	-	-0.8/+1	-1/+2	
			Vddana=2.7V Vref=2.0V	-	-1/+1.1	-1/+2.4	
Gain	Gain Error <sup>(1)</sup>	Fadc = 1 Msps	Vddana=2.7V Vref=2.0V	-	+/-13	+/-28	mV
			Vddana=5.0V Vref=4.096V	-	+/-26	+/-52	

Symbol	Parameter	Conditions		Measurement			Unit
				Min	Typ	Max	
			Vddana=3.0V Vref=Vddana	-	+/-14	+/-24	
			Vddana=5.0V Vref=Vddana		+/-22	+/-42	
TCg	Gain Drift	Fadc = 1 Msps	Vddana=5.0V Vref=Vddana	-170	-140	-80	uV/°C
Offset	Offset Error <sup>(1)</sup>	Fadc = 1 Msps	Vddana=2.7V Vref=2.0V	-	+/-2.2	+/-21	mV
			Vddana=5.0V Vref=4.096V	-	+/-2.3	+/-61	
			Vddana=3.0V Vref=Vddana	-	+/-15	+/-42	
			Vddana=5.0V Vref=Vddana		+/-31	+/-80	
Tco	Offset Drift	Fadc = 1 Msps	Vddana=5.0V Vref=Vddana	160	180	210	µV/°C
SFDR		Spurious Free Dynamic Range	Fs = 1Msps / Fin = 14 kHz / Full range Input signal Vddana=5.0V Vref=Vddana	69	71	73	dB
SINAD		Signal to Noise and Distortion ratio		57	60	61	
SNR		Signal to Noise ratio		57	61	61	
THD				-72	-70	-66	
		Noise RMS	External Reference voltage	-	0.7	2.0	

1. These values are based on characterization. These values are not covered by test limits in production.
2. For best ENOB with external reference, comparator offset cancellation is recommended to be turned off (SAMPCTRL.OFFCOMP=0).

**Table 42-21. Power Consumption<sup>(1)</sup>**

Symbol	Parameters	Conditions	Ta	Typ.	Max	Units
IDD VDDANA	Differential mode	fs = 1 Msps / Reference buffer disabled / BIASREFBUF = '111', BIASREFCOMP = '111' VDDANA=Vref= 5.5V	Max 85°C Typ 25°C	905	1021	µA
		fs = 1 Msps / Reference buffer enabled / BIASREFBUF = '111', BIASREFCOMP = '111' VDDANA=Vref= 5.5V		1062	1184	
		fs = 10 kbps / Reference buffer disabled / BIASREFBUF = '111', BIASREFCOMP = '111' VDDANA=Vref= 5.5V		381	460	
		fs = 10 kbps / Reference buffer enabled / BIASREFBUF = '111', BIASREFCOMP = '111' VDDANA=Vref= 5.5V		525	643	
	Single Ended mode	fs = 1 Msps / Reference buffer disabled / BIASREFBUF = '111', BIASREFCOMP = '111' VDDANA=Vref=5.5V	Max 85°C Typ 25°C	984	1077	
		fs = 1 Msps / Reference buffer enabled / BIASREFBUF = '111', BIASREFCOMP = '111' VDDANA=Vref=5.5V		1103	1237	
		fs = 10 kbps / Reference buffer disabled / BIASREFBUF = '111', BIASREFCOMP = '111' VDDANA=Vref= 5.5V		437	528	
		fs = 10 kbps / Reference buffer enabled / BIASREFBUF = '111', BIASREFCOMP = '111' VDDANA=Vref= 5.5V		553	675	

1. These are based on characterization.

## 42.10.5 Analog Comparator Characteristics

**Table 42-22. Analog Comparator Characteristics**

Symbol	Parameters	Conditions	Min	Typ	Max	Unit
PNIVR	Positive and Negative input range voltage		0	-	VDDANA	V
ICMR	Input common mode range		0	-	VDDANA	V
Off <sup>(1)(2)</sup>	Offset	Low power COMPCTRLn.SPEED = 0x0	-36	+0.4/+2	+48	mV
		High speed COMPCTRLn.SPEED = 0x3	-12	-0.1/+1	+20	
V <sub>HYS</sub> <sup>(1)(3)</sup>	Hysteresis	High speed	58	106	140	mV

Symbol	Parameters	Conditions	Min	Typ	Max	Unit
		COMPCTRLn.SPEED = 0x3				
T <sub>PD</sub> <sup>(1)</sup>	Propagation Delay V <sub>cm</sub> =V <sub>ddana</sub> /2  V <sub>in</sub> = ±100mV overdrive from V <sub>cm</sub>	Low power COMPCTRLn.SPEED = 0x0	-	133	237	ns
		High speed COMPCTRLn.SPEED = 0x3	-	38	73	
T <sub>START</sub> <sup>(1)</sup>	Startup time	Low power COMPCTRLn.SPEED = 0x0	-	6.5	8.5	μs
		High speed COMPCTRLn.SPEED = 0x3	-	2	3	
V <sub>SCALE</sub> <sup>(1)</sup>	INL		-	0.2	-	LSB
	DNL		-	0.023	-	
	Offset Error		-	0.049	-	
	Gain Error		-	0.064	-	

1. These are based on characterization.
2. Hysteresis disabled.
3. Hysteresis enabled.

**Table 42-23. Power Consumption<sup>(1)</sup>**

Symbol	Parameters	Conditions	T <sub>a</sub>	Typ.	Max	Units
IDDANA	Current consumption - V <sub>CM</sub> =V <sub>DDANA</sub> /2  ±100 mV overdrive from V <sub>cm</sub>  Voltage scaler disabled	COMPCTRLn.SPEED = 0x0 V <sub>DDANA</sub> =3.3V	Max 85°C  Typ 25°C	10	13	μA
		COMPCTRLn.SPEED = 0x3 V <sub>DDANA</sub> =3.3V		39	50	
	Current consumption Voltage scaler only	V <sub>DDANA</sub> =3.3V		43	54	

1. These are based on characterization.

## 42.10.6 Voltage Reference Characteristics

**Table 42-24. Voltage Reference Characteristics<sup>(1)</sup>**

Symbol	Parameter	Conditions	Min.	Typ.	Max.	Units
ADC Ref	ADC Internal reference	nom. 1.024V  V <sub>DDANA</sub> =5.0V	1.003	1.024	1.045	V

Symbol	Parameter	Conditions	Min.	Typ.	Max.	Units
		Ta= 25°C				
		nom. 2.048V VDDANA=5.0V Ta= 25°C	2.007	2.048	2.089	
		nom. 4.096V VDDANA=5.0V Ta= 25°C	4.014	4.096	4.178	
	Reference temperature coefficient	Drift over [-40, +25]°C	-	-0.025/0.04	-	%°C
		Drift over [+25, +85]°C	-	-0.015/0.03	-	
		Drift over [+25, +105]°C	-	-0.015/0.03	-	
	Reference supply coefficient	Drift over [2.7, 5.5]V	-	-0.2/0.3	-	%/V

1. These are based on characterization.

## 42.11 NVM Characteristics

**Table 42-25. NVM Max Speed characteristics**

CPU F <sub>MAX</sub> (MHz)	0WS	1WS	2WS
VDD>2.7V	19	38	48
VDD>4.5V	20	38	48

**Table 42-26. NVM Timing Characteristics**

Symbol	Parameter	Max.	Units
t <sub>FPP</sub>	Page Write <sup>(1)</sup>	2.5	ms
t <sub>FRE</sub>	Row erase <sup>(1)</sup>	6	ms

1. These are based on simulation. These values are not covered by test or characterization. For this Flash technology, a maximum number of 8 consecutive writes is allowed per row. Once this number is reached, a row erase is mandatory.

**Table 42-27. Flash Endurance and Data Retention**

Symbol	Parameter	Conditions	Min.	Typ.	Units
Ret <sub>NVM25k</sub>	Retention after up to 25k	Average ambient 55°C	10	50	Years
Ret <sub>NVM2.5k</sub>	Retention after up to 2.5k	Average ambient 55°C	20	100	Years
Ret <sub>NVM100</sub>	Retention after up to 100	Average ambient 55°C	25	>100	Years
Cyc <sub>NVM</sub>	Cycling Endurance <sup>(1)</sup>	-40°C < T <sub>A</sub> < 85°C	25k	-	Cycles

1. An endurance cycle is a write and an erase operation.

**Table 42-28. EEPROM Emulation<sup>(1)</sup> Endurance and Data Retention**

Symbol	Parameter	Conditions	Min.	Typ.	Units
Ret <sub>EEPROM100k</sub>	Retention after up to 100k	Average ambient 55°C	10	50	Years
Ret <sub>EEPROM10k</sub>	Retention after up to 10k	Average ambient 55°C	20	100	Years
CyC <sub>EEPROM</sub>	Cycling Endurance <sup>(2)</sup>	-40°C < Ta < 85°C	100k	-	Cycles

1. The EEPROM emulation is a software emulation described in the App note AT03265.
2. An endurance cycle is a write and an erase operation.

**Table 42-29. Flash erase and programming current**

Symbol	Parameter	Typ.	Units
I <sub>DDIN</sub>	Maximum Current (peak) during whole programming or erase operation	10	mA

## 42.12 Oscillator Characteristics

### 42.12.1 Crystal Oscillator (XOSC) Characteristics

#### 42.12.1.1 Digital Clock Characteristics

The following table describes the characteristics for the oscillator when a digital clock is applied on XIN.

**Table 42-30. Digital Clock Characteristics**

Symbol	Parameter	Condition	Min	Typ	Max	Units
f <sub>CPXIN</sub>	XIN clock frequency	Digital mode	-	-	48	MHz
DC <sub>XIN</sub> <sup>(1)</sup>	XIN clock duty cycle	Digital mode	40	50	60	%

1. These are based on simulation. These values are not covered by test or characterization

#### 42.12.1.2 Crystal Oscillator Characteristics

The following table describes the characteristics for the oscillator when a crystal is connected between XIN and XOUT as shown in [Figure 42-5](#). The user must choose a crystal oscillator where the crystal load capacitance C<sub>L</sub> is within the range given in the table. The exact value of C<sub>L</sub> can be found in the crystal datasheet. The capacitance of the external capacitors (C<sub>LEXT</sub>) can then be computed as follows:

$$C_{LEXT} = 2(C_L + C_{STRAY} - C_{SHUNT})$$

where C<sub>STRAY</sub> is the capacitance of the pins and PCB, C<sub>SHUNT</sub> is the shunt capacitance of the crystal.

**Figure 42-5. Oscillator Connection**



**Table 42-31. Multi Crystal Oscillator Electrical Characteristics (1)**

Symbol	Parameter	Conditions	Min.	Typ.	Max	Units
Fout	Crystal oscillator frequency		0.4	-	32	MHz
ESR	Crystal Equivalent Series Resistance - SF = 3	F = 0.455 MHz CL = 100pF XOSC.GAIN = 0	-	-	443	$\Omega$
		F = 2MHz CL=20pF XOSC.GAIN=0	-	-	383	
		F = 4MHz CL=20pF XOSC.GAIN=1	-	-	218	
		F = 8MHz CL=20pF XOSC.GAIN=2	-	-	114	
		F = 16MHz CL=20pF XOSC.GAIN=3	-	-	61	
		F = 32MHz CL=18pF	-	-	41	



Symbol	Parameter	Conditions	Min.	Typ.	Max	Units
		XOSC.GAIN=4				
Cxin	Parasitic load capacitor		-	5.9	-	pF
Cxout			-	3.1	-	
Tstart	Startup time	F = 2MHz CL=20pF XOSC.GAIN=0	-	12.3	48	Cycles
		F = 4MHz CL=20pF XOSC.GAIN=1	-	8.2	30.1	
		F = 8MHz CL=20pF XOSC.GAIN=2	-	6.2	19.9	
		F = 16MHz CL=20pF XOSC.GAIN=3	-	10.8	30.1	
		F = 32MHz CL=18pF XOSC.GAIN=4	-	8.7	20.1	

1. These are based on characterization.

**Table 42-32. Power Consumption <sup>(1)</sup>**

Symbol	Parameters	Conditions	Ta	Typ.	Max	Units
IDD	Current consumption	F = 2MHz CL=20pF XOSC.GAIN=0 VDD = 5.0V AGC=OFF	Max 85°C Typ 25°C	150	202	µA
		AGC=ON				
		F = 4MHz CL=20pF XOSC.GAIN=1 VDD = 5.0V		220	288	

Symbol	Parameters	Conditions	Ta	Typ.	Max	Units
		AGC=OFF				
		AGC=ON		175	260	
		F = 8MHz CL=20pF XOSC.GAIN=2 VDD = 5.0V AGC=OFF		350	416	
		AGC=ON		247	321	
		F = 16MHz CL=20pF XOSC.GAIN=3 VDD = 5.0V AGC=OFF		663	843	
		AGC=ON		429	699	
		F = 32MHz CL=20pF XOSC.GAIN=4 VDD = 5.0V AGC=OFF		1975	2329	
		AGC=ON		874	1181	

## 42.12.2 External 32 kHz Crystal Oscillator (XOSC32K) Characteristics

### 42.12.2.1 Digital Clock Characteristics

The following table describes the characteristics for the oscillator when a digital clock is applied on XIN32 pin.

**Table 42-33. Digital Clock Characteristics**

Symbol	Parameter	Condition	Typ	Units
f <sub>CPXIN32</sub>	XIN32 clock frequency	Digital mode	32.768	MHz
DC <sub>XIN32</sub>	XIN32 clock duty cycle	Digital mode	50	%

### 42.12.2.2 Crystal Oscillator Characteristics

The following table describes the characteristics for the oscillator when a crystal is connected between XIN32 and XOUT32.

Figure 42-6. Oscillator Connection



The user must choose a crystal oscillator where the crystal load capacitance  $C_L$  is within the range given in the table. The exact value of  $C_L$  can be found in the crystal datasheet. The capacitance of the external capacitors ( $C_{LEXT}$ ) can then be computed as follows:

$$C_{LEXT} = 2(C_L - C_{STRAY} - C_{SHUNT})$$

where  $C_{STRAY}$  is the capacitance of the pins and PCB and  $C_{SHUNT}$  is the shunt capacitance of the crystal.

Table 42-34. 32kHz Crystal Oscillator Characteristics

Symbol	Parameter	Conditions	Min.	Typ.	Max	Units
$f_{OUT}^{(1)}$	Crystal oscillator frequency		-	32768	-	Hz
$C_L^{(1)}$	Crystal load capacitance		-	-	12.5	pF
$C_{SHUNT}^{(1)}$	Crystal shunt capacitance		-	-	1.75	
$C_m^{(1)}$	Motional capacitance		-	1.25	-	fF
ESR	Crystal Equivalent Series Resistance - SF = 3	F = 32.768kHz, $C_L = 12.5$ pF	-	-	79	kΩ
Cxin32k	Parasitic capacitor load		-	2.9	-	pF
Cxout32k			-	3.2	-	
Tstart	Startup time	F = 32.768kHz, $C_L = 12.5$ pF	-	16	24	Kcycles

1. These are based on simulation. These values are not covered by test or characterization

Table 42-35. Power Consumption<sup>(1)</sup>

Symbol	Parameters	Conditions	Ta	Typ.	Max	Units
$I_{DD}$	Current consumption	VDD = 5.0V	Max 85°C Typ 25°C	1528	1720	nA

1. These are based on characterization.

### 42.12.3 Digital Phase Locked Loop (DPLL) Characteristics

**Table 42-36. Fractional Digital Phase Locked Loop Characteristics**

Symbol	Parameter	Conditions	Min.	Typ.	Max.	Units
$f_{IN}^{(1)}$	Input frequency		32		2000	KHz
$f_{OUT}^{(1)}$	Output frequency		48		96	MHz
$J_p^{(2)}$	Period jitter (Peak-Peak value)	$f_{IN}= 32\text{ kHz}, f_{OUT}= 48\text{ MHz}$	-	1.5	3.0	%
		$f_{IN}= 32\text{ kHz}, f_{OUT}= 96\text{ MHz}$	-	2.7	8.0	
		$f_{IN}= 2\text{ MHz}, f_{OUT}= 48\text{ MHz}$	-	1.8	4.0	
		$f_{IN}= 2\text{ MHz}, f_{OUT}= 96\text{ MHz}$	-	2.5	6.0	
$t_{LOCK}^{(2)}$	Lock Time	After startup, time to get lock signal. $f_{IN}= 32\text{ kHz},$ $f_{OUT}= 96\text{ MHz}$	-	1.1	1.5	ms
		After startup, time to get lock signal. $f_{IN}= 2\text{ MHz},$ $f_{OUT}= 96\text{ MHz}$	-	25	35	$\mu\text{s}$
Duty	Duty cycle		-	50	-	%

1. These values are based on simulation. These values are not covered by test limits in production or characterization.
2. These values are based on characterization.

**Table 42-37. Power Consumption<sup>(1)</sup>**

Symbol	Parameters	Conditions	Ta	Typ.	Max	Units
IDD	Current Consumption	Ck=48MHz, VDD=5.0V	Max 85°C	536	612	$\mu\text{A}$
		Ck=96MHz, VDD=5.0V	Typ 25°C	865	970	

1. These values are based on characterization.

### 42.12.4 32.768kHz Internal oscillator (OSC32K) Characteristics

**Table 42-38. 32 kHz RC Oscillator Characteristics**

Symbol	Parameter	Condition	Min	Typ	Max	Units
$f_{OUT}$	Output frequency	T =25°C, VDDANA = 5.0V	32.112	32.768	33.423	kHz
		T =25°C, over [2.7, 5.5]V	29.491	32.768	36.044	
		over [-40, 85]°C, over [2.7, 5.5]V	25.559	32.768	37.355	
$t_{STARTUP}$	Startup time			1	2	cycle
Duty <sup>(1)</sup>	Duty Cycle			50		%

1. These are based on simulation. These values are not covered by test or characterization.

**Table 42-39. Power Consumption<sup>(1)</sup>**

Symbol	Parameters	Conditions	Ta	Typ.	Max	Units
I <sub>DD</sub>	Current consumption	VDD = 5.0V	Max 85°C Typ 25°C	0.864	1.080	μA

1. These are based on characterization.

## 42.12.5 Ultra Low Power Internal 32kHz RC Oscillator (OSCULP32K) Characteristics

**Table 42-40. Ultra Low Power Internal 32 kHz RC Oscillator Electrical Characteristics**

Symbol	Parameter	Condition	Min	Typ	Max	Units
f <sub>OUT</sub>	Output frequency	T =25°C, VDDANA = 5.0V	30.965	32.768	34.57	kHz
		T =25°C, over [2.7, 5.5]V	30.801	32.768	34.73	
		Over [-40, 85]°C, over [2.7, 5.5]V	22.937	32.768	38.99	
Duty	Duty Cycle			50		%

## 42.12.6 48MHz RC Oscillator (OSC48M) Characteristics

**Table 42-41. RC 48MHz Oscillator Electrical Characteristics**

Symbol	Parameter	Conditions	Min.	Typ.	Max	Units
F <sub>OUT</sub> <sup>(1)(2)(3)</sup>	Output frequency	0 to 40 °C	47.52	48	48.48	MHz
		-20 to 85 °C	47.28	48	48.72	
		-40 to 85 °C	47.04	48	48.96	
T <sub>START</sub> <sup>(4)</sup>	Startup time		-	3.9	15	μs
Duty <sup>(5)</sup>	Duty Cycle		-	50	-	%

1. Rev C silicon - VDD limited range = [3.0 - 5.0 V].
2. Rev D silicon - full VDD range [2.7 - 5.5 V], by adjusting OSCCTRL.CAL48M. See Errata reference 15342.
3. Applicable for all package types except the WLCSP, on which accuracy is degraded by ±1% from the current values.
4. OSC48MSTUP.STARTUP field must be set accordingly.
5. These are based on simulation. These values are not covered by test or characterization.

**Table 42-42. Power Consumption**

Symbol	Parameters	Conditions	Ta	Typ.	Max	Units
I <sub>DD</sub>	Current consumption	Fout = 48 MHz, VDD =5.0V	Max 85°C Typ 25°C	87	174	μA

## 42.13 Timing Characteristics

### 42.13.1 SERCOM in SPI Mode Timing

**Table 42-43. SPI Timing Characteristics and Requirements <sup>(1)</sup>**

Symbol	Parameter	Conditions		Min.	Typ.	Max.	Units
tSCK	SCK period	Master	Reception	$2*(t_{MIS}+t_{SLAVE\_OUT})^{(3)}$	-	-	ns
		Master	Transmission	$2*(t_{MOV}+t_{SLAVE\_IN})^{(4)}$	-	-	
tSCKW	SCK high/low width	Master		-	$0.5*t_{SCK}$	-	ns
tSCKR	SCK rise time <sup>(2)</sup>	Master		-	$0.25*t_{SCK}$	-	ns
tSCKF	SCK fall time <sup>(2)</sup>	Master		-	$0.25*t_{SCK}$	-	ns
tMIS	MISO setup to SCK	Master, VDD>4.5V		50.7	-	-	ns
		Master, VDD>2.7V		60.6	-	-	
tMIH	MISO hold after SCK	Master, VDD>4.5V		0	-	-	ns
		Master, VDD>2.7V		0	-	-	
tMOV	MOSI output valid SCK	Master, VDD>4.5V		-	-	17.1	ns
		Master, VDD>2.7V		-	-	23.6	
tMOH	MOSI hold after SCK	Master, VDD>4.5V		2.5	-	-	ns
		Master, VDD>2.7V		2.5	-	-	
tSSCK	Slave SCK Period	Slave	Reception	$2*(t_{SIS}+t_{MASTER\_OUT})^{(5)}$	-	-	ns
		Slave	Transmission	$2*(t_{SOV}+t_{MASTER\_IN})^{(6)}$	-	-	
tSSCKW	SCK high/low width	Slave		-	$0.5*t_{SSCK}$	-	ns
tSSCKR	SCK rise time <sup>(2)</sup>	Slave		-	$0.25*t_{SSCK}$	-	ns
tSSCKF	SCK fall time <sup>(2)</sup>	Slave		-	$0.25*t_{SSCK}$	-	ns
tSIS	MOSI setup to SCK	Slave, VDD>4.5V		13.6	-	-	ns
		Slave, VDD>2.7V		14.1	-	-	
tSIH	MOSI hold after SCK	Slave, VDD>4.5V		0	-	-	ns
		Slave, VDD>2.7V		0	-	-	
tSSS	SS setup to SCK	Slave	PRELOADEN=1	$t_{SOSS}+t_{EXT\_MIS}+2*t_{APBC}^{(8)(9)}$	-	-	ns
			PRELOADEN=0	$t_{SOSS}+t_{EXT\_MIS}^{(8)}$	-	-	
tSSH	SS hold after SCK	Slave		$0.5*t_{SSCK}$	-	-	ns
tSOV	MISO output valid SCK	Slave, VDD>4.5V		-	-	45	ns
		Slave, VDD>2.7V	-	-	55.1		
tSOH	MISO hold after SCK	Slave, VDD>4.5V		11.9	-	-	ns
		Slave, VDD>2.7V	11.9	-	-		
tSOSS	MISO setup after SS low	Slave, VDD>4.5V		-	-	41	ns
		Slave, VDD>2.7V		-	-	50.7	
tSOSH	MISO hold after SS high	Slave, VDD>4.5V		11.1	-	-	ns
		Slave, VDD>2.7V		11.1	-	-	

1. These values are based on simulation. These values are not covered by test limits in production.
2. See I/O pin characteristics.
3. Where  $t_{\text{SLAVE\_OUT}}$  is the slave external device output response time, generally  $t_{\text{EXT\_SOV}} + t_{\text{LINE\_DELAY}}$  (7).
4. Where  $t_{\text{SLAVE\_IN}}$  is the slave external device input constraint, generally  $t_{\text{EXT\_SIS}} + t_{\text{LINE\_DELAY}}$  (7).
5. Where  $t_{\text{MASTER\_OUT}}$  is the master external device output response time, generally  $t_{\text{EXT\_MOV}} + t_{\text{LINE\_DELAY}}$  (7).
6. Where  $t_{\text{MASTER\_IN}}$  is the master external device input constraint, generally  $t_{\text{EXT\_MIS}} + t_{\text{LINE\_DELAY}}$  (7).
7.  $t_{\text{LINE\_DELAY}}$  is the transmission line time delay.
8.  $t_{\text{EXT\_MIS}}$  is the input constraint for the master external device.
9.  $t_{\text{APBC}}$  is the APB period for SERCOM.

**Figure 42-7. SPI Timing Requirements in Master Mode**



**Figure 42-8. SPI Timing Requirements in Slave Mode**



## 42.13.2 External Reset

Table 42-44. External Reset Characteristics<sup>(1)</sup>

Symbol	Parameter	Min.	Units
$t_{EXT}$	Minimum reset pulse width	1	$\mu s$

1. These are based on simulation. These values are not covered by test or characterization



## 43. Electrical Characteristics 105°C (SAM C20J/G/E)

### 43.1 Disclaimer

All typical values are measured at  $T_a = 25^\circ\text{C}$  unless otherwise specified. All minimum and maximum values are valid across operating temperature and voltage unless otherwise specified.

This chapter only contains characteristics specific for the SAM C20J/G/E ( $T_a = 105^\circ\text{C}$ ). For all other values or missing characteristics, refer to the  $85^\circ\text{C}$  chapter.

### 43.2 General Operating Ratings

The device must operate within the ratings listed in the table below in order for all other electrical characteristics and typical characteristics of the device to be valid.

**Table 43-1. General operating conditions**

Symbol	Parameter	Min.	Typ.	Max.	Units
$T_A$	Temperature range	-40	25	105	$^\circ\text{C}$
$T_J$	Junction temperature	-	-	125	$^\circ\text{C}$

### 43.3 Power Consumption

**Table 43-2. Power Consumption<sup>(1)</sup>**

Mode	Conditions	$T_a$	Vcc	Typ.	Max.	Units
ACTIVE	CPU running a While 1 algorithm	$25^\circ\text{C}$	5.0V	3.8	4.2	mA
		$105^\circ\text{C}$	5.0V	4.0	4.5	
	CPU running a While 1 algorithm	$25^\circ\text{C}$	3.0V	3.7	4.1	mA
		$105^\circ\text{C}$	3.0V	4.0	4.5	
	CPU running a While 1 algorithm. with GCLKIN as reference	$25^\circ\text{C}$	5.0V	$71 \cdot \text{Freq} + 160$	$78 \cdot \text{Freq} + 162$	$\mu\text{A}$ (with freq in MHz)
		$105^\circ\text{C}$	5.0V	$71 \cdot \text{Freq} + 374$	$72 \cdot \text{Freq} + 819$	
	CPU running a Fibonacci algorithm	$25^\circ\text{C}$	5.0V	4.7	5.2	mA
		$105^\circ\text{C}$	5.0V	5.0	5.5	
	CPU running a Fibonacci algorithm	$25^\circ\text{C}$	3.0V	4.7	5.1	mA
		$105^\circ\text{C}$	3.0V	5.0	5.5	
	CPU running a Fibonacci algorithm. with GCLKIN as reference	$25^\circ\text{C}$	5.0V	$90 \cdot \text{Freq} + 163$	$99 \cdot \text{Freq} + 168$	$\mu\text{A}$ (with freq in MHz)
		$105^\circ\text{C}$	5.0V	$90 \cdot \text{Freq} + 379$	$92 \cdot \text{Freq} + 820$	
	CPU running a CoreMark algorithm	$25^\circ\text{C}$	5.0V	5.9	6.4	mA
		$105^\circ\text{C}$	5.0V	6.3	6.9	

Mode	Conditions	Ta	Vcc	Typ.	Max.	Units
	CPU running a CoreMark algorithm	25°C	3.0V	5.2	5.7	mA
		105°C	3.0V	5.5	6.1	
	CPU running a CoreMark algorithm. with GCLKIN as reference	25°C	5.0V	115*Freq+167	126*Freq+167	µA (with freq in MHz)
		105°C	5.0V	118*Freq+383	121*Freq+823	
IDLE		25°C	5.0V	1.2	1.3	mA
		105°C	5.0V	1.5	2.6	
STANDBY	XOSC32K running RTC running at 1kHz	25°C	5.0V	15.9	37.0	µA
		105°C	5.0V	187.0	512.0	
	XOSC32K and RTC stopped	25°C	5.0V	14.6	35.0	
		105°C	5.0V	185.0	510.0	

1. These are based on characterization.

## 43.4 Analog Characteristics

### 43.4.1 Brown Out Detector Characteristics - BODVDD

**Table 43-3. Power Consumption<sup>(1)</sup>**

Symbol	Parameters	Conditions	Ta	Typ.	Max	Units
I <sub>DD</sub>	IDLE, Mode CONT	VDD = 2.7V	Max 105°C	22.5	26.7	µA
		VDD = 5.0V	Typ 25°C	41.0	47.9	
	IDLE, Mode SAMPL	VDD = 2.7V		0.1	1.5	
		VDD = 5.0V		0.1	1.9	
	STANDBY, Mode SAMPL	VDD = 2.7V		0.8	2.1	
		VDD = 5.0V		3.5	4.9	

1. These are based on characterization.

#### Related Links

[NVM User Row Mapping](#)

[NVM User Row Mapping](#)

### 43.4.2 Analog-to-Digital Converter (ADC) Characteristics

**Table 43-4. Power Consumption<sup>(1)</sup>**

Symbol	Parameters	Conditions	Ta	Typ.	Max	Units
IDD VDDANA	Differential mode	fs = 1 Msps / Reference buffer disabled / BIASREFBUF = '111',	Max 105°C Typ 25°C	905	1034	µA

Symbol	Parameters	Conditions	Ta	Typ.	Max	Units
		BIASREFCOMP = '111' VDDANA=Vref= 5.5V		1062	1199	
		fs = 1 Msps / Reference buffer enabled / BIASREFBUF = '111', BIASREFCOMP = '111' VDDANA=Vref= 5.5V				
		fs = 10 ksps / Reference buffer disabled / BIASREFBUF = '111', BIASREFCOMP = '111' VDDANA=Vref= 5.5V		381	466	
		fs = 10 ksps / Reference buffer enabled / BIASREFBUF = '111', BIASREFCOMP = '111' VDDANA=Vref= 5.5V		525	654	
	Single Ended mode	fs = 1 Msps / Reference buffer disabled / BIASREFBUF = '111', BIASREFCOMP = '111' VDDANA=Vref=5.5V	Max 105°C Typ 25°C	984	1090	
		fs = 1 Msps / Reference buffer enabled / BIASREFBUF = '111', BIASREFCOMP = '111' VDDANA=Vref=5.5V		1103	1249	
		fs = 10 ksps / Reference buffer disabled / BIASREFBUF = '111', BIASREFCOMP = '111' VDDANA=Vref= 5.5V		437	536	
		fs = 10 ksps / Reference buffer enabled / BIASREFBUF = '111', BIASREFCOMP = '111' VDDANA=Vref= 5.5V		553	688	

1. These are based on characterization.

### 43.4.3 Analog Comparator (AC) Characteristics

**Table 43-5. Power Consumption<sup>(1)</sup>**

Symbol	Parameters	Conditions	Ta	Typ.	Max	Units
IDDANA	Current consumption - Vcm=Vddana/2, +-100 mV overdrive from Vcm, Voltage scaler disabled	COMPCTRLn.SPEED = 0x0, VDDANA =3.3V	Max 105°C Typ 25°C	10	13	µA
		COMPCTRLn.SPEED = 0x3, VDDANA =3.3V		39	51	
	Current consumption Voltage scaler only	VDDANA =3.3V		43	57	

1. These values are based on characterization.

## 43.5 NVM Characteristics

**Table 43-6. Flash Endurance**

Symbol	Parameter	Conditions	Min.	Typ.	Units
Cyc <sub>NVM</sub>	Cycling Endurance <sup>(1)</sup>	-40°C < T <sub>A</sub> < 105°C	5k	-	Cycles

1. An endurance cycle is a write and an erase operation.

**Table 43-7. EEPROM Emulation<sup>(1)</sup> Endurance**

Symbol	Parameter	Conditions	Min.	Typ.	Units
Cyc <sub>EEPROM</sub>	Cycling Endurance <sup>(2)</sup>	-40°C < T <sub>A</sub> < 105°C	100k	-	Cycles

1. The EEPROM emulation is a software emulation described in the application note AT03265.
2. An endurance cycle is a write and an erase operation.

## 43.6 Oscillator Characteristics

### 43.6.1 Crystal Oscillator (XOSC) Characteristics

**Table 43-8. Power Consumption<sup>(1)</sup>**

Symbol	Parameters	Conditions	T <sub>A</sub>	Typ.	Max	Units	
IDD	Current consumption	F = 2MHz CL=20pF XOSC.GAIN=0 VDD = 5.0V	AGC=OFF	Max 105°C	150	206	μA
			AGC=ON	Typ 25°C	138	198	
		F = 4MHz CL=20pF XOSC.GAIN=1 VDD = 5.0V	AGC=OFF		220	293	
			AGC=ON		175	267	
		F = 8MHz CL=20pF XOSC.GAIN=2 VDD = 5.0V	AGC=OFF		350	425	
			AGC=ON		247	331	
		F = 16MHz CL=20pF XOSC.GAIN=3 VDD = 5.0V	AGC=OFF		663	861	
			AGC=ON		429	725	

Symbol	Parameters	Conditions	T <sub>A</sub>	Typ.	Max	Units
		F = 32MHz CL=20pF XOSC.GAIN=4 VDD = 5.0V				
				1975	2397	
				874	1252	

1. These are based on characterization

### 43.6.2 External 32kHz Crystal Oscillator (XOSC32K) Characteristics

**Table 43-9. Power Consumption<sup>(1)</sup>**

Symbol	Parameters	Conditions	T <sub>a</sub>	Typ.	Max	Units
I <sub>DD</sub>	Current consumption	V <sub>DD</sub> = 5.0V	Max 105°C Typ 25°C	1528	1740	nA

1. These are based on characterization.

### 43.6.3 Digital Phase Locked Loop (DPLL) Characteristics

**Table 43-10. Power Consumption<sup>(1)</sup>**

Symbol	Parameters	Conditions	T <sub>a</sub>	Typ.	Max	Units
I <sub>DD</sub>	Current Consumption	Ck=48MHz V <sub>DD</sub> =5.0V	Max 105°C Typ 25°C	536	629	μA
		Ck=96MHz V <sub>DD</sub> =5.0V		865	986	

1. These are based on characterization.

### 43.6.4 32.768kHz Internal Oscillator (OSC32K) Characteristics

**Table 43-11. 32 kHz RC Oscillator Electrical Characteristics**

Symbol	Parameter	Conditions	Min.	Typ.	Max	Units
F <sub>OUT</sub>	Output frequency	T=25°C VDDANA = 5.0V	32.112	32.768	33.423	kHz
		T=25°C Over [2.7, 5.5]V	29.491	32.768	36.044	kHz
		Over [-40,105]°C Over [2.7, 5.5]V	25.559	32.768	37.683	kHz
T <sub>startup</sub>	Startup time		-	1	2	cycles
Duty <sup>(1)</sup>	Duty cycle		-	50	-	%

- These are based on simulation. These values are not covered by test or characterization.

**Table 43-12. Power Consumption**

Symbol	Parameters	Conditions	Ta	Typ.	Max	Units
I <sub>DD</sub>	Current consumption	VDD = 5.0V	Max 105°C Typ 25°C	0.864	1.116	μA

- These are based on characterization.

### 43.6.5 Ultra Low Power Internal 32kHz RC Oscillator (OSCULP32K) Characteristics

**Table 43-13. Ultra Low Power Internal 32 kHz RC Oscillator Characteristics**

Symbol	Parameter	Conditions	Min.	Typ.	Max	Units
F <sub>out</sub>	Output frequency	T=25°C VDDANA = 5.0V	30.965	32.768	34.57	kHz
		T=25°C Over [2.7, 5.5]V	30.801	32.768	34.734	
		Over [-40, 105]°C Over [2.7, 5.5]V	22.937	32.768	40.632	
Duty	Duty Cycle		-	50	-	%

### 43.6.6 48MHz RC Oscillator (OSC48M) Characteristics

**Table 43-14. RC 48MHz Oscillator Electrical Characteristics**

Symbol	Parameter	Conditions	Min.	Typ.	Max	Units
F <sub>OUT</sub> <sup>(1)(2)(3)</sup>	Output frequency	0 to 40°C	47.52	48	48.48	MHz
		-20 to 85°C	47.28	48	48.72	
		-40 to 105°C	46.8	48	49.2	
T <sub>START</sub> <sup>(4)</sup>	Startup time		-	3.9	15	μs
Duty <sup>(5)</sup>	Duty Cycle		-	50	-	%

- Rev C silicon - VDD limited range = [3.0 - 5.0 V].
- Rev D silicon - full VDD range [2.7 - 5.5 V], by adjusting OSCCTRL.CAL48M. See Errata reference 15342.
- SAM C20N silicon - full VDD range [2.7 - 5.5 V]
- OSC48MSTUP.STARTUP field must be set accordingly.
- These are based on simulation. These values are not covered by test or characterization.

**Table 43-15. Power Consumption<sup>(1)</sup>**

Symbol	Parameters	Conditions	Ta	Typ.	Max	Units
I <sub>DD</sub>	Current consumption	F <sub>OUT</sub> = 48 MHz	Max 105°C	87	267	μA

Symbol	Parameters	Conditions	Ta	Typ.	Max	Units
		V <sub>DD</sub> =5.0V	Typ 25°C			

1. These are based on characterization.

## 44. Electrical Characteristics 105°C (SAM C20N)

### 44.1 Disclaimer

All typical values are measured at Ta = 25°C unless otherwise specified. All minimum and maximum values are valid across operating temperature and voltage unless otherwise specified.

This chapter only contains characteristics specific for the SAM C20N devices (Ta = 105°C). For all other values or missing characteristics, refer to the SAM C20J/G/E 85°C and 105°C chapters.

#### Related Links

[Electrical Characteristics 85°C \(SAM C20J/G/E\)](#)

### 44.2 General Operating Ratings

The device must operate within the ratings listed in the table below in order for all other electrical characteristics and typical characteristics of the device to be valid.

**Table 44-1. General operating conditions**

Symbol	Parameter	Min.	Typ.	Max.	Units
T <sub>A</sub>	Temperature range	-40	25	105	°C
T <sub>J</sub>	Junction temperature	-	-	125	°C

### 44.3 Power Consumption

**Table 44-2. Power Consumption<sup>(1)</sup>**

Mode	Conditions	Ta	Vcc	Typ.	Max.	Units
ACTIVE	CPU running a While 1 algorithm	25°C	5.0V	3.8	4.2	mA
		105°C	5.0V	4.0	5.0	
	CPU running a While 1 algorithm	25°C	3.0V	3.7	4.1	mA
		105°C	3.0V	4.0	5.0	
	CPU running a While 1 algorithm. with GCLKIN as reference	25°C	5.0V	71*Freq+160	78*Freq+162	µA (with freq in MHz)
		105°C	5.0V	71*Freq+374	68*Freq+1564	
	CPU running a Fibonacci algorithm	25°C	5.0V	4.7	5.2	mA
		105°C	5.0V	5.0	6.1	
	CPU running a Fibonacci algorithm	25°C	3.0V	4.7	5.1	mA
		105°C	3.0V	5.0	6.0	
	CPU running a Fibonacci algorithm. with GCLKIN as reference	25°C	5.0V	90*Freq+163	99*Freq+168	µA (with freq in MHz)
		105°C	5.0V	90*Freq+379	90*Freq+1568	
	CPU running a CoreMark algorithm	25°C	5.0V	5.9	6.4	mA



Mode	Conditions	Ta	Vcc	Typ.	Max.	Units
		105°C	5.0V	6.3	7.1	
	CPU running a CoreMark algorithm	25°C	3.0V	5.2	5.7	mA
		105°C	3.0V	5.5	6.6	
	CPU running a CoreMark algorithm. with GCLKIN as reference	25°C	5.0V	115*Freq+167	126*Freq+167	μA (with freq in MHz)
105°C		5.0V	118*Freq+383	110*Freq+1583		
IDLE		25°C	5.0V	1.2	1.7	mA
		105°C	5.0V	1.5	2.6	
STANDBY	XOSC32K running RTC running at 1kHz	25°C	5.0V	15.9	37.0	μA
		105°C	5.0V	187.0	602.0	
	XOSC32K and RTC stopped	25°C	5.0V	14.6	35.0	
		105°C	5.0V	185.0	600.0	

1. These are based on characterization.

## 44.4 Analog Characteristics

### 44.4.1 Power On Reset (POR) Characteristics

**Table 44-3. POR Characteristics**

Symbol	Parameters	Min	Typ	Max	Unit
V <sub>POT+</sub>	Voltage threshold Level on VDDIN rising	-	2.55	-	V
V <sub>POT-</sub>	Voltage threshold Level on VDDIN falling	1.77	1.92	2.04	

**Figure 44-1. POR Operating Principle**



#### 44.4.2 Brown Out Detectors (BOD) Characteristics

1. See NVM User Row Mapping table for the BODVDD default value settings.
2. These values are based on simulation. These values are not covered by test limits in production or characterization.

**Figure 44-2. BODVDD Hysteresis OFF**



**Figure 44-3. BODVDD Hysteresis ON**



**Table 44-4. BODVDD Characteristics<sup>(2)</sup>**

Symbol	Parameters	Conditions	Min	Typ	Max	Unit
VBOD+ <sup>(1)</sup>	BODVDD high threshold Level	VDD level, Bod setting = 8 (default)	-	2.86	2.98	V
		VDD level, Bod setting = 9	-	2.92	3.01	
		VDD level, Bod setting = 44	-	4.57	4.82	
VBOD- / VBOD <sup>(1)</sup>	BODVDD low threshold Level	VDD level, Bod setting = 8 (default)	2.71	2.80	2.90	

Symbol	Parameters	Conditions	Min	Typ	Max	Unit
		VDD level, Bod setting = 9	2.75	2.85	2.96	
		VDD level, Bod setting = 44	4.37	4.51	4.66	
	Step size		-	60	-	mV
VHys <sup>(1)</sup>	Hysteresis (VBOD+ - VBOD-) BODVDD.LEVEL = 8 to 48	VDD	40	-	75	mV
T <sub>START</sub> <sup>(3)</sup>	Startup time	Time from enable to RDY	-	3.1	-	μs

1. These are based on characterization.
2. BODVDD in continuous mode.
3. These are based on simulation. These values are not covered by test or characterization.

### 44.4.3 Analog-to-Digital Converter (ADC) Characteristics

**Table 44-5. Operating Conditions<sup>(1)</sup>**

Symbol	Parameters	Conditions	Min	Typ	Max	Unit
Res	Resolution		-	-	12	bits
Rs	Sampling rate		10	-	1000	ksps
fs	Sampling clock		10	-	1000	kHz
	Differential mode Number of ADC clock cycles SAMPCTRL.OFFCOMP=1	resolution 12 bit (CTRLC.RESSEL=0)	-	16	-	cycles
		resolution 10 bit (CTRLC.RESSEL=2)		14		
		resolution 8 bit (CTRLC.RESSEL=3)		12		
	Differential mode Number of ADC clock cycles SAMPCTRL.OFFCOMP=0 SAMPLEN corresponds to the decimal value of SAMPCTRL.SAMPLEN[5:0] register	resolution 12 bit (CTRLC.RESSEL=0)	-	SAMPLEN +13	-	cycles
		resolution 10 bit (CTRLC.RESSEL=2)		SAMPLEN +11		
		resolution 8 bit (CTRLC.RESSEL=3)		SAMPLEN+9		
	Single-ended mode Number of ADC clock cycles SAMPCTRL.OFFCOMP=1	resolution 12 bit (CTRLC.RESSEL=0)	-	16	-	cycles
		resolution 10 bit (CTRLC.RESSEL=2)		15		
		resolution 8 bit (CTRLC.RESSEL=3)		13		
	Single-ended mode Number of ADC clock cycles SAMPCTRL.OFFCOMP=0 SAMPLEN corresponds to the decimal value of SAMPCTRL.SAMPLEN[5:0] register	resolution 12 bit (CTRLC.RESSEL=0)	-	SAMPLEN +13	-	cycles
		resolution 10 bit (CTRLC.RESSEL=2)		SAMPLEN +12		
		resolution 8 bit (CTRLC.RESSEL=3)		SAMPLEN +10		
fadc	ADC Clock frequency	SAMPCTRL.OFFCOMP=1 or CTRLC.R2R=1	-	fs*16	-	Hz

Symbol	Parameters	Conditions	Min	Typ	Max	Unit
		SAMPCTRL.OFFCOMP=0	-	fs*13	-	
Ts	Sampling time	SAMPCTRL.OFFCOMP=1 or CTRLC.R2R=1	250	-	25000	ns
		SAMPCTRL.OFFCOMP=0	76	-	7692	
	Sampling time with DAC as input	SAMPCTRL.OFFCOMP=1 or CTRLC.R2R=1	3000	-	25000	
		SAMPCTRL.OFFCOMP=0	3000	-	7692	
	Conversion range	Differential mode	-VREF	-	+VREF	V
	Conversion range	Single-ended mode	0	-	VREF	
Vref	Reference input	REFCTRL.REFCOMP=1	2	-	VDDANA-0.6	V
		REFCTRL.REFCOMP=0	VDDANA	-	VDDANA	
Vin	Input channel range	-	0	-	VDDANA	V
Vcmin	Input common mode voltage	CTRLC.R2R=1	0.2	-	VREF-0.2	V
		CTRLC.R2R=0	VREF/2-0.2	-	VREF/2+0.2	V
CSAMPLE	Input sampling capacitance		-	1.6	4.5	pF
RSAMPLE	Input sampling on-resistance	For a sampling rate at 1 Msps	-	1000	1715	Ω
Rref	Reference input source resistance		0	-	1000	kΩ

1. These values are based on simulation. These values are not covered by test limits in production or characterization.

**Figure 44-4. ADC Analog Input AINx**



The minimum sampling time  $t_{\text{samplehold}}$  for a given  $R_{\text{source}}$  can be found using this formula:

$$t_{\text{samplehold}} \geq (R_{\text{sample}} + R_{\text{source}}) \times C_{\text{sample}} \times (n + 2) \times \ln(2)$$

For 12-bit accuracy:

$$t_{\text{samplehold}} \geq (R_{\text{sample}} + R_{\text{source}}) \times C_{\text{sample}} \times 9.7$$

where  $t_{\text{samplehold}} \geq \frac{1}{2 \times f_{\text{ADC}}}$ .

**Table 44-6. Differential Mode**

Symbol	Parameter	Conditions	Measurement			Unit	
			Min	Typ	Max		
ENOB <sup>(1)</sup>	Effective Number of bits	Fadc = 500 ksp/s - R2R disabled	Vddana=5.0V Vref=Vddana	9.9	10.7	11.4	bits
			Vddana=2.7V Vref=2.0V	10.0	10.8	11.3	
		Fadc = 1 Msps - R2R disabled	Vddana=5.0V Vref=Vddana	9.7	10.6	11.3	
			Vddana=2.7V Vref=2.0V	9.8	10.6	11.2	
		Fadc = 500 ksp/s - R2R Enabled <sup>(2)</sup>	Vddana=5.0V Vref=Vddana	9.8	11.3	11.9	
		Fadc = 1 Msps - R2R Enabled <sup>(2)</sup>	Vddana=5.0V Vref=Vddana	9.7	11.1	11.8	
TUE	Total Unadjusted Error	Fadc = 500 ksp/s - R2R disabled with offset and gain compensation	Vddana=5.0V Vref=Vddana	-	+/-3.4	+/-5	LSB
			Vddana=2.7V Vref=2.0V	-	+/-3	+/-5.6	
		Fadc = 1 Msps - R2R disabled with offset and gain compensation	Vddana=5.0V Vref=Vddana	-	+/-4.2	+/-6.3	
			Vddana=2.7V Vref=2.0V	-	+/-3.6	+/-7.7	
INL	Integral Non Linearity	Fadc = 500 ksp/s - R2R disabled	Vddana=5.0V Vref=Vddana	-	+/-1.9	+/-3.5	LSB
			Vddana=2.7V Vref=2.0V	-	+/-1.6	+/-3.5	
		Fadc = 1 Msps - R2R disabled	Vddana=5.0V Vref=Vddana	-	+/-2	+/-3.3	
			Vddana=2.7V Vref=2.0V	-	+/-1.9	+/-3.6	
DNL	Differential Non Linearity	Fadc = 500 ksp/s - R2R disabled	Vddana=5.0V Vref=Vddana	-	-0.9/+1	-1/+1.2	LSB
			Vddana=2.7V Vref=2.0V	-	-0.9/+1.1	-1/+2.1	
		Fadc = 1 Msps - R2R disabled	Vddana=5.0V Vref=Vddana	-	-0.9/+1	-1/+1	
			Vddana=2.7V Vref=2.0V	-	-1/+1.6	-1/+3.6	
Gain	Gain Error	Fadc = 1 Msps - R2R disabled w/o gain compensation	Vddana=5.0V Vref=Vddana	-	+/-0.06	+/-0.3	%
			Vddana=2.7V Vref=2.0V	-	+/-0.06	+/-1.2	
			Vddana=5.0V 1V internal Ref	-	+/-1.9	+/-6.5	
			Vddana=5.0V Vref=Vddana/2	-	+/-0.11	+/-0.82	
		Fadc = 1 Msps - R2R disabled with gain compensation	Vddana=2.7V Vref=2.0V	-	+/-0.03	+/-0.46	
			Vddana=5.0V Vref=Vddana/2	-	+/-0.13	+/-0.58	
Offset	Offset Error	Fadc = 1 Msps - R2R disabled without offset compensation	Vddana=5.0V Vref=Vddana/2	-	+/-0.8	+/-13	mV
			Vddana=2.7V Vref=2.0V	-	+/-0.7	+/-9.7	

Symbol	Parameter	Conditions	Measurement			Unit	
			Min	Typ	Max		
		Fadc = 1 Msps - R2R disabled with offset compensation	Vddana=5.0V Vref=Vddana/2	-	+/-0.01	+/-5.6	
			Vddana=2.7V Vref=2.0V	-	+/-0.4	+/-4.2	
SFDR		Spurious Free Dynamic Range	Fs = 1Msps / Fin = 14 kHz / Full range Input signal Vddana=5.0V Vref=Vddana	63	71	81	dB
SINAD(1)		Signal to Noise and Distortion ratio		60	65	70	
SNR at -3 db FS		Signal to Noise ratio		64	67	70	
THD		Total Harmonic Distortion		63	-70	81	
		Noise RMS	External Reference voltage	-	0.4	3.2	mV

1. Referred to Full Scale.
2. Dynamical input range is +/-6% of Full scale.

**Table 44-7. Single-Ended Mode**

Symbol	Parameter	Conditions	Measurement			Unit	
			Min	Typ	Max		
ENOB <sup>(1)</sup>	Effective Number of bits	Fadc = 500 ksps - R2R disabled	Vddana=3.0V Vref=Vddana	9.0	9.7	10.2	bits
			Vddana=3.0V Vref=2.0V	9.0	9.6	10.1	
		Fadc = 1 Msps - R2R disabled	Vddana=3.0V Vref=Vddana	8.9	9.6	10.0	
			Vddana=3.0V Vref=2.0V	8.9	9.4	9.7	
TUE	Total Unadjusted Error	Fadc = 500 ksps - R2R disabled with offset and gain compensation	Vddana=5.0V Vref=Vddana	-	+/-12.9	+/-25.2	LSB
			Vddana=2.7V Vref=2.0V	-	+/-25	+/-49.6	
		Fadc = 1 Msps - R2R disabled with offset and gain compensation	Vddana=5.0V Vref=Vddana	-	+/-13.5	+/-26.4	
			Vddana=2.7V Vref=2.0V	-	+/-27	+/-52	
INL	Integral Non Linearity	Fadc = 500 ksps - R2R disabled	Vddana=5.0V Vref=Vddana	-	+/-3.7	+/-6.5	LSB
			Vddana=2.7V Vref=2.0V	-	+/-3.4	+/-5.9	
		Fadc = 1 Msps - R2R disabled	Vddana=5.0V Vref=Vddana	-	+/-4.2	+/-7.4	
			Vddana=2.7V Vref=2.0V	-	+/-3.5	+/-6.2	
DNL	Differential Non Linearity	Fadc = 500 ksps - R2R disabled	Vddana=5.0V Vref=Vddana	-	-0.9/+1.2	-1/+1.6	
			Vddana=2.7V Vref=2.0V	-	-0.9/+1.3	-1/+2.3	
		Fadc = 1 Msps - R2R disabled	Vddana=5.0V Vref=Vddana	-	-1/+1.1	-1/+1.3	
			Vddana=2.7V Vref=2.0V	-	-1/+1.4	-1/+3.1	
Gain	Gain Error	Fadc = 1 Msps - R2R disabled w/o gain compensation	Vddana=5.0V Vref=Vddana	-	+/-0.2	+/-0.7	%
			Vddana=2.7V Vref=2.0V	-	+/-0.3	+/-1.4	
			Vddana=5.0V 1V internal Ref	-	+/-1.6	+/-6.6	
			Vddana=5.0V Vref=Vddana/2	-	+/-0.2	+/-1.1	

Symbol	Parameter	Conditions	Measurement			Unit	
			Min	Typ	Max		
		Fadc = 1 Msps - R2R disabled with gain compensation	Vddana=2.7V Vref=2.0V	-	+/-0.3	+/-0.8	
			Vddana=5.0V Vref=Vddana/2	-	+/-0.1	+/-0.5	
Offset	Offset Error	Fadc = 1 Msps - R2R disabled	Vddana=5.0V Vref=Vddana	-	+/-7	+/-63	mV
			Vddana=2.7V Vref=2.0V	-	+/-7	+/-64	
SFDR		Spurious Free Dynamic Range	Fs = 1Msps / Fin = 14 kHz / Full range Input signal Vddana=5.0V Vref=Vddana	57	66	73	dB
SINAD(1)		Signal to Noise and Distortion ratio		54	59	62	
SNR at -3 db FS		Signal to Noise ratio		57	60	62	
THD		Total Harmonic Distortion		-71	-64	-56	
		Noise RMS	External Reference voltage	-	0.6	1.9	mV

1. Referred to Full Scale.

#### 44.4.4 Analog Comparator Characteristics

**Table 44-8. Analog Comparator Characteristics**

Symbol	Parameters	Conditions	Min	Typ	Max	Unit
PNIVR	Positive and Negative input range voltage		0	-	VDDANA	V
ICMR	Input common mode range		0	-	VDDANA	V
Off <sup>(1)(2)</sup>	Offset	Low power COMPCTRLn.SPEED = 0x0	-55	-4/+2	51	mV
		High speed COMPCTRLn.SPEED = 0x3	-22	-2/+1	20	
V <sub>HYS</sub> <sup>(1)(3)</sup>	Hysteresis	High speed COMPCTRLn.SPEED = 0x3	39	106	156	mV
T <sub>PD</sub> <sup>(1)</sup>	Propagation Delay Vcm=Vddana/2 Vin = ±100mV overdrive from Vcm	Low power COMPCTRLn.SPEED = 0x0	-	149	268	ns
		High speed COMPCTRLn.SPEED = 0x3	-	41	73	
T <sub>START</sub> <sup>(1)</sup>	Startup time	Low power COMPCTRLn.SPEED = 0x0	-	6.8	10.4	μs
		High speed COMPCTRLn.SPEED = 0x3	-	2.2	3.7	
V <sub>SCALE</sub> <sup>(1)</sup>	INL		-	0.569	-	LSB

Symbol	Parameters	Conditions	Min	Typ	Max	Unit
	DNL		-	0.053	-	
	Offset Error		-	0.042	-	
	Gain Error		-	0.041	-	

1. These are based on characterization.
2. Hysteresis disabled.
3. Hysteresis enabled.

#### 44.4.5 Voltage Reference Characteristics

**Table 44-9. Voltage Reference Characteristics<sup>(1)</sup>**

Symbol	Parameter	Conditions	Min.	Typ.	Max.	Units
ADC Ref	ADC Internal reference	nom. 1.024V VDDANA=5.0V Ta= 25°C	1.003	1.024	1.045	V
		nom. 2.048V VDDANA=5.0V Ta= 25°C	2.007	2.048	2.089	
		nom. 4.096V VDDANA=5.0V Ta= 25°C	4.014	4.096	4.178	
	Reference temperature coefficient	Drift over [-40, +25]°C	-	-0.016/0.028	-	% / °C
		Drift over [+25, +85]°C	-	-0.022/0.029	-	
		Drift over [+25, +105]°C	-	-0.031/0.03	-	
	Reference supply coefficient	Drift over [2.7, 5.5]V	-	-0.2/0.3	-	% / V

1. These are based on characterization.

#### 44.5 NVM Characteristics

**Table 44-10. NVM Max Speed characteristics**

CPU F <sub>MAX</sub> (MHz)	0WS	1WS	2WS
VDD>2.7V	19	38	48
VDD>4.5V	19	38	48



44.6 Oscillator Characteristics

44.6.1 Crystal Oscillator (XOSC) Characteristics

The following table describes the characteristics for the oscillator when a digital clock is applied on XIN.

Table 44-11. Digital Clock Characteristics

Symbol	Parameter	Condition	Min	Typ	Max	Units
$f_{CPXIN}$	XIN clock frequency	Digital mode	-	-	48	MHz
$DC_{XIN}^{(1)}$	XIN clock duty cycle	Digital mode	40	50	60	%

- These are based on simulation. These values are not covered by test or characterization

The following table describes the characteristics for the oscillator when a crystal is connected between XIN and XOUT as shown in the figure below. The user must choose a crystal oscillator where the crystal load capacitance  $C_L$  is within the range given in the table. The exact value of  $C_L$  can be found in the crystal datasheet. The capacitance of the external capacitors ( $C_{LEXT}$ ) can then be computed as follows:

$$C_{LEXT} = 2(C_L + C_{STRAY} - C_{SHUNT})$$

where  $C_{STRAY}$  is the capacitance of the pins and PCB,  $C_{SHUNT}$  is the shunt capacitance of the crystal.

Figure 44-5. Oscillator Connection



Table 44-12. Multi Crystal Oscillator Electrical Characteristics (1)

Symbol	Parameter	Conditions	Min.	Typ.	Max	Units
$F_{out}$	Crystal oscillator frequency		0.4	-	32	MHz
ESR	Crystal Equivalent Series Resistance - SF = 3	F = 0.455 MHz CL = 100pF XOSC.GAIN = 0	-	-	443	$\Omega$
		F = 2MHz CL=20pF	-	-	383	

Symbol	Parameter	Conditions	Min.	Typ.	Max	Units
		XOSC.GAIN=0				
		F = 4MHz CL=20pF XOSC.GAIN=1	-	-	218	
		F = 8MHz CL=20pF XOSC.GAIN=2	-	-	114	
		F = 16MHz CL=20pF XOSC.GAIN=3	-	-	58	
		F = 32MHz CL=12pF XOSC.GAIN=4	-	-	62	
Cxin	Parasitic load capacitor		-	6.7	-	pF
Cxout			-	4.1	-	
Tstart	Startup time	F = 2MHz CL=20pF XOSC.GAIN=0	-	12.3	48.7	Cycles
		F = 4MHz CL=20pF XOSC.GAIN=1	-	8.2	30.1	
		F = 8MHz CL=20pF XOSC.GAIN=2	-	6.2	19.9	
		F = 16MHz CL=20pF XOSC.GAIN=3	-	10.8	30.1	
		F = 32MHz CL=12pF XOSC.GAIN=4	-	8.7	23.6	

1. These are based on characterization.

#### 44.6.2 External 32kHz Crystal Oscillator (XOSC32K) Characteristics

The following table describes the characteristics for the oscillator when a digital clock is applied on XIN32 pin.

**Table 44-13. Digital Clock Characteristics<sup>(1)</sup>**

Symbol	Parameter	Condition	Typ	Units
$f_{CPXIN32}$	XIN32 clock frequency	Digital mode	32.768	kHz
$DC_{XIN32}$	XIN32 clock duty cycle	Digital mode	50	%

1. These are based on simulation. These values are not covered by test or characterization

The following table describes the characteristics for the oscillator when a crystal is connected between XIN32 and XOUT32.

**Figure 44-6. Oscillator Connection**



The user must choose a crystal oscillator where the crystal load capacitance  $C_L$  is within the range given in the table. The exact value of  $C_L$  can be found in the crystal datasheet. The capacitance of the external capacitors ( $C_{LEXT}$ ) can then be computed as follows:

$$C_{LEXT} = 2(C_L - C_{STRAY} - C_{SHUNT})$$

where  $C_{STRAY}$  is the capacitance of the pins and PCB and  $C_{SHUNT}$  is the shunt capacitance of the crystal.

**Table 44-14. 32kHz Crystal Oscillator Characteristics**

Symbol	Parameter	Conditions	Min.	Typ.	Max	Units
$f_{OUT}^{(1)}$	Crystal oscillator frequency		-	32768	-	Hz
$C_L^{(1)}$	Crystal load capacitance		-	-	12.5	pF
$C_{SHUNT}^{(1)}$	Crystal shunt capacitance		-	-	1.75	
$C_M^{(1)}$	Motional capacitance		-	1.25	-	fF
ESR	Crystal Equivalent Series Resistance - SF = 3	F = 32.768kHz, $C_L = 12.5$ pF	-	-	70	kΩ
$C_{XIN32K}$	Parasitic capacitor load		-	3.8	-	pF

Symbol	Parameter	Conditions	Min.	Typ.	Max	Units
C <sub>XOUT32K</sub>			-	4.1	-	
T <sub>START</sub>	Startup time	F = 32.768kHz, C <sub>L</sub> =12.5 pF	-	16	24	Kcycles

1. These are based on simulation. These values are not covered by test or characterization

### 44.6.3 32.768kHz Internal Oscillator (OSC32K) Characteristics

**Table 44-15. 32 kHz RC Oscillator Electrical Characteristics**

Symbol	Parameter	Conditions	Min.	Typ.	Max	Units
F <sub>OUT</sub>	Output frequency	Ta=25°C VDDANA = 5.0V	30.965	32.768	34.570	kHz
		Ta=25°C Over [2.7, 5.5]V	29.164	32.768	36.044	kHz
		Over [-40,105]°C Over [2.7, 5.5]V	25.559	32.768	37.683	kHz
T <sub>STARTUP</sub>	Startup time		-	1	2	cycles
Duty <sup>(1)</sup>	Duty cycle		-	50	-	%

1. These are based on simulation. These values are not covered by test or characterization.

### 44.6.4 48MHz RC Oscillator (OSC48M) Characteristics

**Table 44-16. Power Consumption<sup>(1)</sup>**

Symbol	Parameters	Conditions	Ta	Typ.	Max	Units
I <sub>DD</sub>	Current consumption	F <sub>OUT</sub> = 48 MHz VDD =5.0V	Max 105°C Typ 25°C	87	341	μA

1. These are based on characterization.

## 45. Packaging Information

### 45.1 Thermal Considerations

#### 45.1.1 Thermal Resistance Data

The following table summarizes the thermal resistance data depending on the package.

**Table 45-1. Thermal Resistance Data**

Package Type	$\theta_{JA}$	$\theta_{JC}$
32-pin TQFP	63.1°C/W	14.3°C/W
48-pin TQFP	62.7°C/W	11.6°C/W
64-pin TQFP	56.3°C/W	11.1°C/W
100-pin TQFP	55.0°C/W	11.1°C/W
32-pin QFN	40.5°C/W	16.0°C/W
48-pin QFN	30.9°C/W	10.4°C/W
64-pin QFN	31.4°C/W	10.2°C/W
56-ball WLCSP	37.5°C/W	5.48°C/W

#### 45.1.2 Junction Temperature

The average chip-junction temperature,  $T_J$ , in °C can be obtained from the following:

1.  $T_J = T_A + (P_D \times \theta_{JA})$
2.  $T_J = T_A + (P_D \times (\theta_{HEATSINK} + \theta_{JC}))$

where:

- $\theta_{JA}$  = Package thermal resistance, Junction-to-ambient (°C/W), see Thermal Resistance Data
- $\theta_{JC}$  = Package thermal resistance, Junction-to-case thermal resistance (°C/W), see Thermal Resistance Data
- $\theta_{HEATSINK}$  = Thermal resistance (°C/W) specification of the external cooling device
- $P_D$  = Device power consumption (W)
- $T_A$  = Ambient temperature (°C)

From the first equation, the user can derive the estimated lifetime of the chip and decide if a cooling device is necessary or not. If a cooling device is to be fitted on the chip, the second equation should be used to compute the resulting average chip-junction temperature  $T_J$  in °C.

## 45.2 Package Drawings

### 45.2.1 100 pin TQFP



**Table 45-2. Device and Package Maximum Weight**

500	mg
-----	----

**Table 45-3. Package Characteristics**

Moisture Sensitivity Level	MSL3
----------------------------	------

**Table 45-4. Package Reference**

JEDEC Drawing Reference	MS-026
JESD97 Classification	e3

## 45.2.2 64 pin TQFP

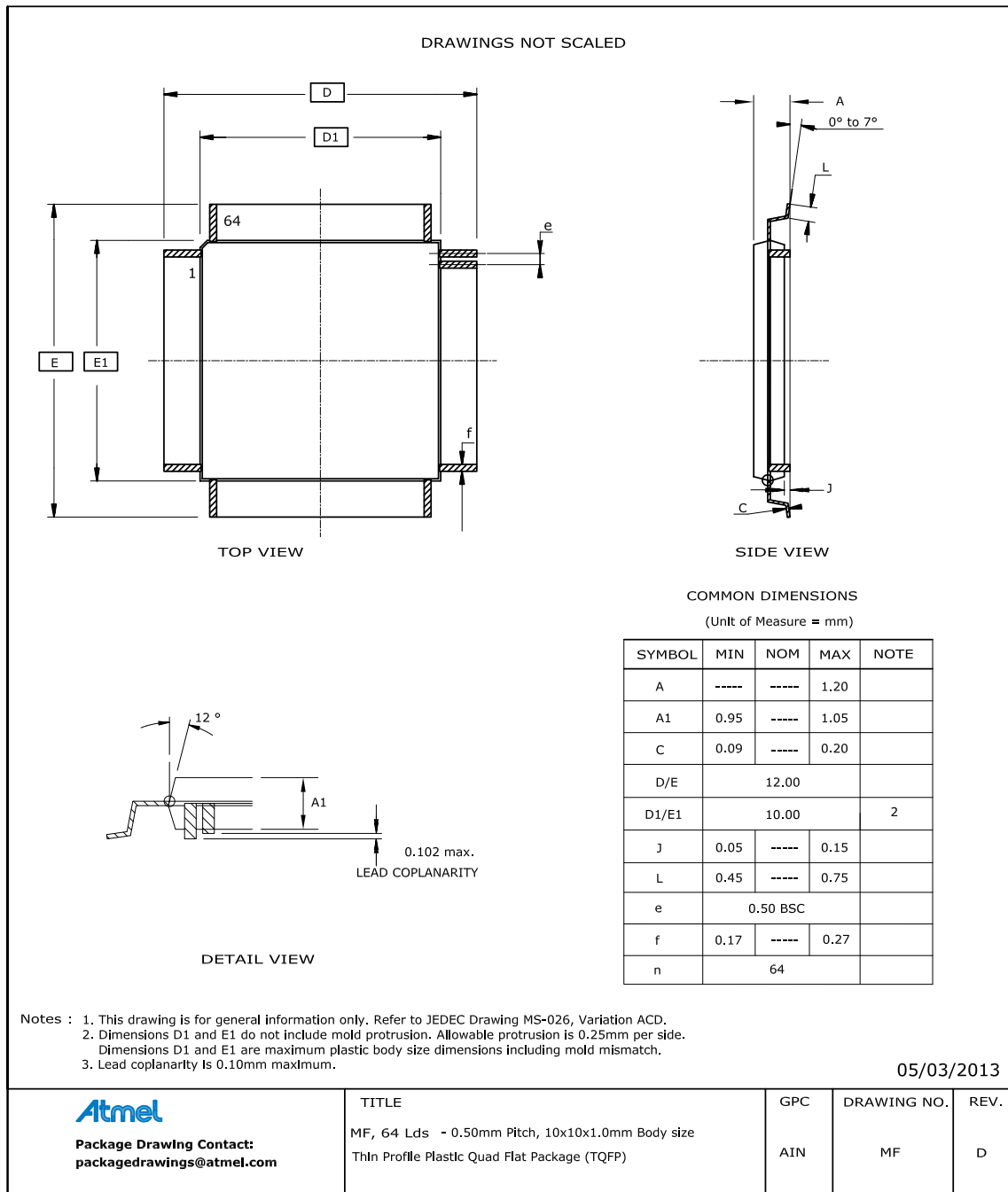

**Table 45-5. Device and Package Maximum Weight**

300	mg
-----	----

**Table 45-6. Package Characteristics**

Moisture Sensitivity Level	MSL3
----------------------------	------

**Table 45-7. Package Reference**

JEDEC Drawing Reference	MS-026
JESD97 Classification	E3



## 45.2.3 64 pin QFN



**Note:** The exposed die attach pad is not connected electrically inside the device.

**Table 45-8. Device and Package Maximum Weight**

200	mg
-----	----

**Table 45-9. Package Characteristics**

Moisture Sensitivity Level	MSL3
----------------------------	------

**Table 45-10. Package Reference**

JEDEC Drawing Reference	MO-220
JESD97 Classification	E3

**45.2.4 56-Ball WLCSP**



**Table 45-11. Device and Package Maximum Weight**

9.63	mg
------	----

**Table 45-12. Package Characteristics**

Moisture Sensitivity Level	MSL1
----------------------------	------

**Table 45-13. Package Reference**

JEDEC Drawing Reference	N/A
JESD97 Classification	e1

**45.2.5 48 pin TQFP**

DRAWINGS NOT SCALED

TOP VIEW

SIDE VIEW

COMMON DIMENSIONS  
(Unit of Measure = mm)

SYMBOL	MIN	NOM	MAX	NOTE
A	-----	-----	1.20	
A1	0.05	-----	0.15	
A2	0.95	-----	1.05	
C	0.09	-----	0.20	
D/E	9.00 BSC			
D1/E1	7.00 BSC			
L	0.45	-----	0.75	
b	0.17	-----	0.27	
e	0.50 BSC			

DETAIL VIEW

11 - 13°

A2

0.102 max.  
LEAD COPLANARITY

Notes : 1. This drawing is for general information only. Refer to JEDEC Drawing MS-026, Variation ABC.  
 2. Dimensions D1 and E1 do not include mold protrusion. Allowable protrusion is 0.25mm per side. Dimensions D1 and E1 are maximum plastic body size dimensions including mold mismatch.  
 3. Lead coplanarity is 0.10mm maximum.

10/04/2011

<b>Package Drawing Contact:</b> packagedrawings@atmel.com	TITLE	GPC	DRAWING NO.	REV.
	MC, 48 Lds - 0.5mm Pitch, 7x7x1mm Body size Thin Profile Plastic Quad Flat Package (TQFP)	ALV	MC	E

**Table 45-14. Device and Package Maximum Weight**

140	mg
-----	----

**Table 45-15. Package Characteristics**

Moisture Sensitivity Level	MSL3
----------------------------	------

**Table 45-16. Package Reference**

JEDEC Drawing Reference	MS-026
JESD97 Classification	E3

## 45.2.6 48 pin QFN



**Note:** The exposed die attach pad is not connected electrically inside the device.

**Table 45-17. Device and Package Maximum Weight**

140	mg
-----	----

**Table 45-18. Package Characteristics**

Moisture Sensitivity Level	MSL3
----------------------------	------

**Table 45-19. Package Reference**

JEDEC Drawing Reference	MO-220
JESD97 Classification	E3

**45.2.7 32 pin TQFP**

DRAWINGS NOT SCALED

TOP VIEW

BOTTOM VIEW

SIDE VIEW

COMMON DIMENSIONS  
(Unit of Measure = mm)

SYMBOL	MIN	NOM	MAX	NOTE
A	-----	-----	1.20	
A1	0.05	-----	0.15	
A2	0.95	1.00	1.05	
D/E	8.75	9.00	9.25	
D1/E1	6.90	7.00	7.10	2
C	0.09	-----	0.20	
L	0.45	-----	0.75	
b	0.30	-----	0.45	
e	0.80 TYP			
n	32			

Notes : 1. This drawing is for general information only. Refer to JEDEC Drawing MS-026, Variation ABA.  
 2. Dimensions D1 and E1 do not include mold protrusion. Allowable protrusion is 0.25mm per side. Dimensions D1 and E1 are maximum plastic body size dimensions including mold mismatch.  
 3. Lead coplanarity is 0.10mm maximum.

02/29/2012

<b>Package Drawing Contact:</b> packagedrawings@atmel.com	TITLE	GPC	DRAWING NO.	REV.
	MA, 32 Lds - 0.80mm Pitch, 7x7x1.00mm Body size Thin Profile Plastic Quad Flat Package (TQFP)	AUT	MA	C

**Table 45-20. Device and Package Maximum Weight**

100	mg
-----	----

**Table 45-21. Package Charateristics**

Moisture Sensitivity Level	MSL3
----------------------------	------

**Table 45-22. Package Reference**

JEDEC Drawing Reference	MS-026
JESD97 Classification	E3

**45.2.8 32 pin QFN**

DRAWINGS NOT SCALED

**COMMON DIMENSIONS**  
(Unit of Measure = mm)

SYMBOL	MIN	NOM	MAX	NOTE
A	0.80	----	1.00	
A1	0.00	----	0.05	
D/E	5.00 BSC			
D2/E2	3.50	3.60	3.70	
L	0.30	0.40	0.50	
b	0.18	0.25	0.30	2
e	0.50 BSC			
n	32			

Notes : 1. This drawing is for general information only. Refer to JEDEC Drawing MO-220, Variation VHHD-5, for proper dimensions, tolerances, datums, etc.  
 2. Dimension b applies to metallized terminal and is measured between 0.15mm and 0.30mm from the terminal tip.  
 If the terminal has the optical radius on the other end of the terminal, the dimension should not be measured in that radius area.

10/05/2015

 Package Drawing Contact: packagedrawings@atmel.com	TITLE	GPC	DRAWING NO.	REV.
	PG, 32 Leads, 0.50mm pitch, 5x5x1.0mm Body Size Very Thin Quad Flat No Lead Package (VQFN) Sawn	ZKV	PG	C

**Note:** The exposed die attach pad is connected inside the device to GND and GNDANA.

**Table 45-23. Device and Package Maximum Weight**

90	mg
----	----

**Table 45-24. Package Characteristics**

Moisture Sensitivity Level	MSL3
----------------------------	------

**Table 45-25. Package Reference**

JEDEC Drawing Reference	MO-220
JESD97 Classification	E3

## 45.3 Soldering Profile

The following table gives the recommended soldering profile from J-STD-20.

**Table 45-26.**

Profile Feature	Green Package
Average Ramp-up Rate (217°C to peak)	3°C/s max.
Preheat Temperature 175°C ±25°C	150-200°C
Time Maintained Above 217°C	60-150s
Time within 5°C of Actual Peak Temperature	30s
Peak Temperature Range	260°C
Ramp-down Rate	6°C/s max.
Time 25°C to Peak Temperature	8 minutes max.

A maximum of three reflow passes is allowed per component.



## 46. Schematic Checklist

### 46.1 Introduction

This chapter describes a common checklist which should be used when starting and reviewing the schematics for a SAM C20 design. This chapter illustrates the recommended power supply connections, how to connect external analog references, programmer, debugger, oscillator and crystal.

### 46.2 Operation in Noisy Environment

If the device is operating in an environment with much electromagnetic noise it must be protected from this noise to ensure reliable operation. In addition to following best practice EMC design guidelines, the recommendations listed in the schematic checklist sections must be followed. In particular placing decoupling capacitors very close to the power pins, a RC-filter on the  $\overline{\text{RESET}}$  pin, and a pull-up resistor on the SWCLK pin is critical for reliable operations. It is also relevant to eliminate or attenuate noise in order to avoid that it reaches supply pins, I/O pins and crystals.

### 46.3 Power Supply

The SAM C20 supports a single power supply or dual power supplies from 2.7 to 5.5V.

#### 46.3.1 Power Supply Connections

Figure 46-1. Single Power Supply Schematic



**Figure 46-2. Dual Power Supply Schematic**



**Table 46-1. Power Supply Connections,  $V_{DDCORE}$  From Internal Regulator**

Signal Name	Recommended Pin Connection	Description
$V_{DDIO}$	2.7V to 5.5V Decoupling/filtering capacitors 100nF <sup>(1)(2)</sup> and 10µF <sup>(1)</sup> Decoupling/filtering inductor 10µH <sup>(1)(3)</sup>	I/O supply voltage
$V_{DDANA}$	2.7V to 5.5V Decoupling/filtering capacitors 100nF <sup>(1)(2)</sup> and 10µF <sup>(1)</sup> Ferrite bead <sup>(4)</sup> prevents the $V_{DD}$ noise interfering with $V_{DDANA}$	Analog supply voltage
$V_{DDIN}$	2.7V to 5.5V Decoupling/filtering capacitors 100nF <sup>(1)(2)</sup> and 10µF <sup>(1)</sup> Decoupling/filtering inductor 10µH <sup>(1)(3)</sup>	Digital supply voltage
$V_{DDCORE}$	1.1V to 1.3V typical Decoupling/filtering capacitors 100nF <sup>(1)(2)</sup> and 1µF <sup>(1)</sup>	Core supply voltage / external decoupling pin
GND		Ground
$GND_{ANA}$		Ground for the analog power domain

1. These values are only given as a typical example.

2. Decoupling capacitors should be placed close to the device for each supply pin pair in the signal group, low ESR capacitors should be used for better decoupling.
3. An inductor should be added between the external power and the  $V_{DD}$  for power filtering.
4. A ferrite bead has better filtering performance compared to standard inductor at high frequencies. A ferrite bead can be added between the main power supply ( $V_{DD}$ ) and  $V_{DDANA}$  to prevent digital noise from entering the analog power domain. The bead should provide enough impedance (e.g.  $50\Omega$  at 20MHz and  $220\Omega$  at 100MHz) to separate the digital and analog power domains. Make sure to select a ferrite bead designed for filtering applications with a low DC resistance to avoid a large voltage drop across the ferrite bead.

## 46.4 External Analog Reference Connections

The following schematic checklist is only necessary if the application is using one or more of the external analog references. If the internal references are used instead, the following circuits are not necessary.

**Figure 46-3. External Analog Reference Schematic With Two References**



**Figure 46-4. External Analog Reference Schematic With One Reference**



**Table 46-2. External Analog Reference Connections**

Signal Name	Recommended Pin Connection	Description
VREFA	2.0V to $V_{DDANA} - 0.6V$ for ADC Decoupling/filtering capacitors: 100nF <sup>(1)(2)</sup> and 4.7µF <sup>(1)</sup>	External reference from VREFA pin on the analog port.
GND		Ground

**Note:**

1. These values are given as a typical example.
2. Decoupling capacitor should be placed close to the device for each supply pin pair in the signal group.

## 46.5 External Reset Circuit

The external Reset circuit is connected to the  $\overline{\text{RESET}}$  pin when the external Reset function is used. The circuit is not necessary when the  $\overline{\text{RESET}}$  pin is not driven LOW externally by the application circuitry.

The reset switch can also be removed, if a manual reset is not desired. The  $\overline{\text{RESET}}$  pin itself has an internal pull-up resistor, hence it is optional to add any external pull-up resistor.

**Figure 46-5. External Reset Circuit Schematic**



A pull-up resistor makes sure that the reset does not go low and unintentionally causing a device reset. An additional resistor has been added in series with the switch to safely discharge the filtering capacitor, i.e. preventing a current surge when shorting the filtering capacitor which again can cause a noise spike that can have a negative effect on the system.

**Table 46-3. Reset Circuit Connections**

Signal Name	Recommended Pin Connection	Description
$\overline{\text{RESET}}$	Reset low level threshold voltage $V_{\text{DDIO}} = 1.6\text{V} - 2.0\text{V}$ : Below $0.33 * V_{\text{DDIO}}$ $V_{\text{DDIO}} = 2.7\text{V} - 3.6\text{V}$ : Below $0.36 * V_{\text{DDIO}}$ Decoupling/filter capacitor $100\text{pF}^{(1)}$ Pull-up resistor $2.2\text{k}\Omega^{(1)(2)}$ Resistor in series with the switch $330\Omega^{(1)}$	Reset pin

1. These values are only given as a typical example.
2. The SAM C20 features an internal pull-up resistor on the  $\overline{\text{RESET}}$  pin, hence an external pull-up is optional.

## 46.6 Unused or Unconnected Pins

Unused or unconnected pins (unless marked as NC where applicable) should not be left unconnected and floating. Floating pins will add to the overall power consumption of the device. To prevent this one should always draw the pin voltage towards a given level, either VDD or GND, through a pull up/down resistor. External or internal pull up/down resistors can be used, e.g. the pins can be configured in pull-up or pull-down mode eliminating the need for external components. There are no obvious benefit in choosing external vs. internal pull resistors.

### Related Links

[PORT - I/O Pin Controller](#)

## 46.7 Clocks and Crystal Oscillators

The SAM C20 can be run from internal or external clock sources, or a mix of internal and external sources. An example of usage will be to use the internal 8MHz oscillator as source for the system clock, and an external 32.768kHz watch crystal as clock source for the Real-Time counter (RTC).

### 46.7.1 External Clock Source

**Figure 46-6. External Clock Source Schematic**



**Table 46-4. External Clock Source Connections**

Signal Name	Recommended Pin Connection	Description
XIN	XIN is used as input for an external clock signal	Input for inverting oscillator pin
XOUT/GPIO	Can be left unconnected or used as normal GPIO	NC/GPIO

### 46.7.2 Crystal Oscillator

**Figure 46-7. Crystal Oscillator Schematic**



The crystal should be located as close to the device as possible. Long signal lines may cause too high load to operate the crystal, and cause crosstalk to other parts of the system.

**Table 46-5. Crystal Oscillator Checklist**

Signal Name	Recommended Pin Connection	Description
XIN	Load capacitor 15pF <sup>(1)(2)</sup>	External crystal between 0.4 to 32MHz
XOUT	Load capacitor 15pF <sup>(1)(2)</sup>	

1. These values are only given as a typical example.
2. The capacitors should be placed close to the device for each supply pin pair in the signal group.

## 46.7.3 External Real Time Oscillator

The low frequency crystal oscillator is optimized for use with a 32.768kHz watch crystal. When selecting crystals, load capacitance and the crystal's Equivalent Series Resistance (ESR) must be taken into consideration. Both values are specified by the crystal vendor.

SAM C20 oscillator is optimized for very low power consumption, hence close attention should be made when selecting crystals.

The typical parasitic load capacitance values are available in the Electrical Characteristics section. This capacitance and PCB capacitance can allow using a crystal inferior to 12.5pF load capacitance without external capacitors as shown in [Figure 46-8](#).

**Figure 46-8. External Real Time Oscillator without Load Capacitor**

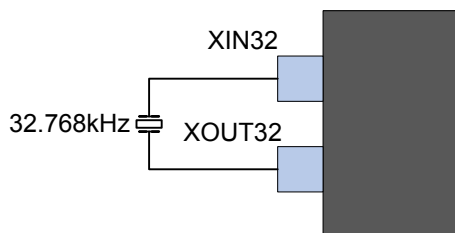

To improve accuracy and Safety Factor, the crystal datasheet can recommend adding external capacitors as shown in [Figure 46-9](#).

To find suitable load capacitance for a 32.768kHz crystal, consult the crystal datasheet.

**Figure 46-9. External Real Time Oscillator with Load Capacitor**



**Table 46-6. External Real Time Oscillator Checklist**

Signal Name	Recommended Pin Connection	Description
XIN32	Load capacitor 22pF <sup>(1)(2)</sup>	Timer oscillator input
XOUT32	Load capacitor 22pF <sup>(1)(2)</sup>	Timer oscillator output

1. These values are only given as typical examples.
2. The capacitors should be placed close to the device for each supply pin pair in the signal group.

**Note:** In order to minimize the cycle-to-cycle jitter of the external oscillator, keep the neighboring pins as steady as possible. For neighboring pin details, refer to the Oscillator Pinout section.

**46.7.4 Calculating the Correct Crystal Decoupling Capacitor**

The model shown in [Figure 46-10](#) can be used to calculate correct load capacitor for a given crystal. This model includes internal capacitors  $C_{L_n}$ , external parasitic capacitance  $C_{EL_n}$  and external load capacitance  $C_{P_n}$ .

**Figure 46-10. Crystal Circuit With Internal, External and Parasitic Capacitance**



Using this model the total capacitive load for the crystal can be calculated as shown in the equation below:

$$\sum C_{tot} = \frac{(C_{L1} + C_{P1} + C_{EL1})(C_{L2} + C_{P2} + C_{EL2})}{C_{L1} + C_{P1} + C_{EL1} + C_{L2} + C_{P2} + C_{EL2}}$$

where  $C_{tot}$  is the total load capacitance seen by the crystal. This value should be equal to the load capacitance value found in the crystal manufacturer datasheet.

The parasitic capacitance  $C_{EL_n}$  can in most applications be disregarded as these are usually very small. If accounted for, these values are dependent on the PCB material and PCB layout.

For some crystal the internal capacitive load provided by the device itself can be enough. To calculate the total load capacitance in this case.  $C_{EL_n}$  and  $C_{P_n}$  are both zero,  $C_{L1} = C_{L2} = C_L$ , and the equation reduces to the following:

$$\sum C_{tot} = \frac{C_L}{2}$$

See the related links for equivalent internal pin capacitance values.

**Related Links**

[Crystal Oscillator Characteristics](#)

**46.8 Programming and Debug Ports**

For programming and/or debugging the SAM C20 the device should be connected using the Serial Wire Debug (SWD) interface. Currently the SWD interface is supported by several Microchip and third party programmers and debuggers, like the SAM-ICE, JTAGICE3 or SAM C21 Xplained Pro (SAM C21 evaluation kit) Embedded Debugger.



Refer to the SAM-ICE, JTAGICE3 or SAM C21 Xplained Pro user guides for details on debugging and programming connections and options. For connecting to any other programming or debugging tool, refer to that specific programmer or debugger's user guide.

The SAM C21 Xplained Pro evaluation board for the SAM C20 supports programming and debugging through the onboard embedded debugger so no external programmer or debugger is needed.

Note that a pull-up resistor on the SWCLK pin is critical for reliable operations. Refer to related link for more information.

**Figure 46-11. SWCLK Circuit Connections**



**Table 46-7. SWCLK Circuit Connections**

Pin Name	Description	Recommended Pin Connection
SWCLK	Serial wire clock pin	Pull-up resistor 1kΩ

### Related Links

[Operation in Noisy Environment](#)

#### 46.8.1 Cortex Debug Connector (10-pin)

For debuggers and/or programmers that support the Cortex Debug Connector (10-pin) interface the signals should be connected as shown in [Figure 46-12](#) with details described in [Table 46-8](#).

Figure 46-12. Cortex Debug Connector (10-pin)



Table 46-8. Cortex Debug Connector (10-pin)

Header Signal Name	Description
SWDCLK	Serial wire clock pin
SWDIO	Serial wire bidirectional data pin
RESET	Target device reset pin, active low
VTref	Target voltage sense, should be connected to the device $V_{DD}$
GND	Ground

#### 46.8.2 10-pin JTAGICE3 Compatible Serial Wire Debug Interface

The JTAGICE3 debugger and programmer does not support the Cortex Debug Connector (10-pin) directly, hence a special pinout is needed to directly connect the SAM C20 to the JTAGICE3, alternatively one can use the JTAGICE3 squid cable and manually match the signals between the JTAGICE3 and SAM C20. [Figure 46-13](#) describes how to connect a 10-pin header that support connecting the JTAGICE3 directly to the SAM C20 without the need for a squid cable. This can also be used for the Atmel-ICE AVR connector port.

The JTAGICE3 squid cable or the JTACICE3 50mil cable can be used to connect the JTAGICE3 programmer and debugger to the SAM C20. [10-pin JTAGICE3 Compatible Serial Wire Debug Interface](#) illustrates the correct pinout for the JTAGICE3 50 mil, and details are given in [Table 46-9](#).

**Figure 46-13. 10-pin JTAGICE3 Compatible Serial Wire Debug Interface**



**Table 46-9. 10-pin JTAGICE3 Compatible Serial Wire Debug Interface**

Header Signal Name	Description
SWDCLK	Serial wire clock pin
SWDIO	Serial wire bidirectional data pin
RESET	Target device reset pin, active low
VTG	Target voltage sense, should be connected to the device $V_{DD}$
GND	Ground

### 46.8.3 20-pin IDC JTAG Connector

For debuggers and/or programmers that support the 20-pin IDC JTAG Connector, e.g. the SAM-ICE, the signals should be connected as shown in [Figure 46-14](#) with details described in [Table 46-10](#).

**Figure 46-14. 20-pin IDC JTAG Connector**



**Table 46-10. 20-pin IDC JTAG Connector**

Header Signal Name	Description
SWDCLK	Serial wire clock pin
SWDIO	Serial wire bidirectional data pin
RESET	Target device reset pin, active low
VCC	Target voltage sense, should be connected to the device $V_{DD}$
GND	Ground
GND*	These pins are reserved for firmware extension purposes. They can be left unconnected or connected to GND in normal debug environment. They are not essential for SWD in general.

## 47. Errata

### 47.1 SAM C20E/G/J

The device variant (last letter of the ordering number) is independent of the die revision (DSU.DID.REVISION): The device variant denotes functional differences, whereas the die revision marks evolution of the die.

#### 47.1.1 Die Revision A

Not sampled.

#### 47.1.2 Die Revision B

##### 47.1.2.1 AC

**1 – Hysteresis is only present for a falling (1->0) transition of the comparator output.**

**Errata reference: 13712**

**Fix/Workaround:**

None

**2 – Low power mode (COMPCTRLn.SPEED = 0x0) with Hysteresis enabled (COMPCTRLn.HYSTEN = 0x1) may result in undesired behavior of the AC.**

**Errata reference: 15714**

**Fix/Workaround:**

Do not use AC Low Power mode (COMPCTRLn.SPEED = 0x0) and hysteresis (COMPCTRLn.HYSTEN = 0x1) together. Use only one of these features to avoid incorrect AC behavior.

##### 47.1.2.2 FDPLL

**1 – When entering standby mode, the FDPLL is still running even if not requested by any module causing extra consumption.**

**Errata reference: 12244**

**Fix/Workaround:**

FDPLL must be disabled before entering in standby mode and re-enabled after wake-up

**2 – When changing on-the-fly the FDPLL ratio in DPLLnRATIO register, STATUS.DPLLnLDRTO will not be set when the ratio update will be completed.**

**Errata reference: 15753**

**Fix/Workaround:**

Wait for the interruption flag INTFLAG.DPLLnLDRTO instead.

##### 47.1.2.3 OSC48M

**1 – When a System Reset is applied, the OSC48MDIV register is reset, but the value is not synchronized. This may result in the system clock running too fast.**

**Errata reference: 14497**

**Fix/Workaround:**

Do not write OSC48MDIV to lower than 0xB.

Do not run the device faster than 4MHz when running from internal oscillators

## 47.1.2.4 PORT

**1 – When the PORT is defined as EVSYS.USER in a synch/resynch path, the first event is transmitted to the PORT but the acknowledgement coming from the PORT is not released. So next coming events are treated as overrun by EVSYS.**

**Errata reference: 14317**

**Fix/Workaround:**

None.

Do not use the synch/resynch path, only use asynchronous path.

**2 – PORT read/write attempts on non-implemented registers, including addresses beyond the last implemented register group (PA, PB,...) do not generate a PAC protection error.**

**Errata reference: 15611**

**Fix/Workaround:**

None

## 47.1.2.5 SDADC

**1 – Poor INL is observed when the SDADC input signal is close to VREF.**

**Errata reference: 15084**

**Fix/Workaround:**

SDADC Differential Input Voltage Range should be limited to +/- 0.7.VREF (and not +/- VREF).

SDADC Single-Ended Input Voltage Range should be limited to 0 to 0.7.VREF (and not 0 to VREF).

## 47.1.2.6 Device

**1 – The SYSTICK calibration value is incorrect.**

**Errata reference: 14156**

**Fix/Workaround:**

The correct SYSTICK calibration value is 0x40000000. This value should not be used to initialize the Systick RELOAD value register, which should be initialized instead with a value depending on the main clock frequency and on the tick period required by the application. For a detailed description of the SYSTICK module, refer to the official ARM Cortex-M0+ documentation.

**2 – In IDLE sleep mode, the APB and AHB clocks are not stopped if the FDPLL is running as a GCLK clock source.**

**Errata reference: 13401**

**Fix/Workaround:**

Disable the FDPLL before entering IDLE sleep mode.

**3 – The Analog Comparators and ADC1 use the same generic clock configuration. GCLK\_ADC1 must be used to configure the clock for AC as GCLK\_AC is not functional.**

**Errata reference: 13404**

**Fix/Workaround:**

None

**4 – Increased power consumption in standby sleep mode.**

**Errata reference: 14100**

**Fix/Workaround:**

None

**5 – In I2C Slave mode, writing the CTRLB register when in the AMATCH or DRDY interrupt service routines can cause the state machine to reset.**

**Errata reference: 13574**

**Fix/Workaround:**

Write CTRLB.ACKACT to 0 using the following sequence:

// If higher priority interrupts exist, then disable so that the

// following two writes are atomic.

SERCOM - STATUS.reg = 0;

SERCOM - CTRLB.reg = 0;

// Re-enable interrupts if applicable.

Write CTRLB.ACKACT to 1 using the following sequence:

// If higher priority interrupts exist, then disable so that the

// following two writes are atomic.

SERCOM - STATUS.reg = 0;

SERCOM - CTRLB.reg = SERCOM\_I2CS\_CTRLB\_ACKACT;

// Re-enable interrupts if applicable.

Otherwise, only write to CTRLB in the AMATCH or DRDY interrupts if it is to close out a transaction.

When not closing a transaction, clear the AMATCH interrupt by writing a 1 to

its bit position instead of using CTRLB.CMD. The DRDY interrupt is

automatically cleared by reading/writing to the DATA register in smart mode.

If not in smart mode, DRDY should be cleared by writing a 1 to its bit position.

Code replacements examples:

Current:

SERCOM - CTRLB.reg |= SERCOM\_I2CS\_CTRLB\_ACKACT;

Change to:

// If higher priority interrupts exist, then disable so that the

// following two writes are atomic.

SERCOM - STATUS.reg = 0;

SERCOM - CTRLB.reg = SERCOM\_I2CS\_CTRLB\_ACKACT;

// Re-enable interrupts if applicable.

Current:

SERCOM - CTRLB.reg &= ~SERCOM\_I2CS\_CTRLB\_ACKACT;

Change to:

// If higher priority interrupts exist, then disable so that the

// following two writes are atomic.

SERCOM - STATUS.reg = 0;

SERCOM - CTRLB.reg = 0;

// Re-enable interrupts if applicable.

Current:

/\* ACK or NACK address \*/

SERCOM - CTRLB.reg |= SERCOM\_I2CS\_CTRLB\_CMD(0x3);

Change to:

// CMD=0x3 clears all interrupts, so to keep the result similar,

// PREC is cleared if it was set.

if (SERCOM - INTFLAG.bit.PREC) SERCOM - INTFLAG.reg =  
SERCOM\_I2CS\_INTFLAG\_PREC;  
SERCOM - INTFLAG.reg = SERCOM\_I2CS\_INTFLAG\_AMATCH;

**6 – VREGSMOD bits have no effect in PM.STDBYCFG register. The power domain controller always operates in automatic regulator mode.**

**Errata reference: 14498**

**Fix/Workaround:**

None

**7 – The OSC48M accuracy cannot be reached for the whole VDD range.**

**Errata reference: 15342**

**Fix/Workaround:**

Rev A / B: none

Rev C: limited VDD range, according to the Electrical Characteristics chapter

Rev D: write OSCCTRL.CAL48M register, depending on the VDD range used.

**8 – The default TC selection as CCL input is not TC0, but TC4. Thus the TC selection for the CCL is TC4/TC0/TC1/TC2 instead of TC0/TC1/TC2/TC3. The TC alternate selection is TC0/TC1/TC2/TC3 instead of TC1/TC2/TC3/TC4.**

**Errata reference: 13449**

**Fix/Workaround:**

Use the TC input mapping described above.

## 47.1.2.7 RTC

**1 – The COUNTSYNC/CLOCKSYNC bit of the RTC.CTRLA register has no effect. Read synchronization of the COUNT/CLOCK register is always enabled.**

**Errata reference: 13714**

**Fix/Workaround:**

None

## 47.1.2.8 OSC32KCTRL

**1 – At start-up and in case of clock failure detection(CFD), the auto switch by the CFD does not work if the XOSC32K is requested by the GCLK.**

**Errata/Workaround**

**Manually change clock from XOSC32K to another 32K source.**

## 47.1.2.9 DAC

**1 – DAC in dithering mode with right adjust data leads to INL of 16 LSBs.**

**Errata reference: 14642**

**Fix/Workaround:**

Use dithering with left adjusted data only

## 47.1.2.10 EVSYS

**1 – The acknowledge between an event user and the EVSYS clears the CHSTATUS.CHBUSYn bit before this information is fully propagated in the EVSYS one GCLK\_EVSYS\_CHANNEL\_n clock cycle later. As a consequence, any generator event occurring on that channel before**



that extra GCLK\_EVSYS\_CHANNEL\_n clock cycle will trigger the overrun flag.

**Errata reference: 14835**

**Fix/Workaround:**

For applications using event generators other than the software event, monitor the OVR flag.

For applications using the software event generator, wait one GCLK\_EVSYS\_CHANNEL\_n clock cycle after the CHSTATUS.CHBUSYn bit is cleared before issuing a software event.

**2 – Using synchronous, spurious overrun can appear with generic clock for the channel always on.**

**Errata reference: 14532**

**Fix/Workaround:**

- Request the generic clock on demand by setting the CHANNEL.ONDEMAND bit to one.
- No penalty is introduced.

## 47.1.2.11 DMAC

**1 – When using more than one DMA channel and if one of these DMA channels has a linked descriptor, a fetch error can appear on this channel.**

**Errata reference: 15670**

**Fix/Workaround:**

Do not use linked descriptors, make a software link instead:

Replace the channel which used linked descriptor by two channels DMA (with linked descriptor disabled) handled by two channels event system:

- DMA channel 0 transfer completion is able to send a conditional event for DMA channel 1 (via event system with configuration of BTCTRL.EVOSEL=BLOCK for channel 0 and configuration CHCTRLB.EVACT=CBLOCK for channel 1).
- On the transfer complete reception of the DMA channel 0, immediately re-enable the channel 0.
- Then DMA channel 1 transfer completion is able to send a conditional event for DMA channel 0 (via event system with configuration of BTCTRL.EVOSEL=BLOCK for channel 1 and configuration CHCTRLB.EVACT=CBLOCK for channel 0).
- On the transfer complete reception of the DMA channel 1, immediately re-enable the channel 1.
- The mechanism can be launched by sending a software event on the DMA channel 0.

**2 – When at least one channel using linked descriptors is already active, enabling another DMA channel (with or without linked descriptors) can result in a channel Fetch Error (FERR) or an incorrect descriptor fetch.**

**This happens if the channel number of the channel being enabled is lower than the channel already active.**

**Errata reference: 15683**

**Fix/Workaround:**

When enabling a DMA channel while other channels using linked descriptors are already active, the channel number of the new channel enabled must be greater than the other channel numbers.

**3 – If data is written to CRCDATAIN in two consecutive instructions, the CRC computation may be incorrect.**

**Errata reference: 13507**

**Fix/Workaround:**

Add a NOP instruction between each write to CRCDATAIN register.

## 47.1.2.12 EIC

**1 – The EIC ASYNCH register is not write protected.**

**Errata reference: 13848**

**Fix/Workaround:**

None

**2 – Changing the NMI configuration(CONFIGn.SENSEx)on the fly may lead to a false NMI interrupt.**

**Errata reference: 15279**

**Fix/Workaround:**

Clear the NMIFLAG bit once the NMI has been modified.

**3 – If the NMI pin PORT config is INPUT+PULL-UP enabled and the NMI is configured to trigger on rising edge (or both edges), the NMI exception is triggered as soon as the NMI config is written.**

**Errata reference: 13074**

**Fix/Workaround:**

Set the NMI pin PORT config, enable EIC in edge detection mode then disable EIC. Clear INTFLAG, then write NMI configuration.

**4 – When the EIC is configured to generate an interrupt on a low level or rising edge or both edges (CONFIGn.SENSEx) with the filter enabled (CONFIGn.FILTENx), a spurious flag might appear for the dedicated pin on the INTFLAG.EXTINT[x] register as soon as the EIC is enabled using CTRLA ENABLE bit.**

**Errata reference: 15278**

**Fix/Workaround:**

Clear the INTFLAG bit once the EIC enabled and before enabling the interrupts.

## 47.1.2.13 NVMCTRL

**1 – The RWW EEPROM cache is not invalidated when performing write or erase operations. Reading RWWEE cached data can result in outdated data.**

**Errata reference: 14633**

**Fix/Workaround:**

When the RWW EEPROM Cache is on (CTRLB.CACHEDIS=0x2 or CTRLB.CACHEDIS=0x3) invalidate the cache by issuing the INVAL NVMCTRL command immediately after issuing a RWW EEPROM write or erase operation.

## 47.1.2.14 SERCOM

**1 – In USART autobaud mode, missing stop bits are not recognized as inconsistent sync (ISF) or framing (FERR) errors.**

**Errata reference: 13852**

**Fix/Workaround:**

None

**2 – If the SERCOM is enabled in SPI mode with SSL detection enabled (CTRLB.SSDE) and CTRLB.RXEN=1, an erroneous slave select low interrupt (INTFLAG.SSL) can be generated.**

**Errata reference: 13369**

**Fix/Workaround:**

Enable the SERCOM first with CTRLB.RXEN=0. In a subsequent write, set CTRLB.RXEN=1.

## 47.1.2.15 TC

**1 – When clearing STATUS.xxBUFV flag, SYNCBUSY is released before the register is restored to its appropriate value.**

**Errata reference: 15056**

**Fix/Workaround:**

To ensure that the register value is properly restored before updating this same register through xx or xxBuf with a new value, the STATUS.xxBUFV flag must be cleared successively two times.

**2 – A capture overflow can occur without INTFLAG.ERR being set if a new capture occurs within 3 APB clock periods + 3 generic clock periods after a previous capture.**

**Errata reference: 13367**

**Fix/Workaround:**

The delay between two capture events must be longer than 3 APB clock periods + 3 generic clock periods.

**3 – The input capture on IO pins does not work.**

**Errata reference: 14024**

**Fix/Workaround:**

Use the input capture through TC event and use the EIC or CCL as event generators.

## 47.1.2.16 TCC

**1 – FCTRLX.CAPTURE[CAPTMARK] does not work as described in the datasheet. CAPTMARK cannot be used to identify captured values triggered by fault inputs source A or B on the same channel.**

**Errata reference: 13316**

**Fix/Workaround:**

Use two different channels to timestamp FaultA and FaultB.

**2 – Using TCC in dithering mode with external retrigger events can lead to unexpected stretch of right aligned pulses, or shrink of left aligned pulses.**

**Errata reference: 15625**

**Fix/Workaround:**

Do not use retrigger events/actions when TCC is configured in dithering mode.

**3 – A capture overflow can occur without INTFLAG.ERR being set if a new capture occurs within 3 APB clocks + 3 generic Clock periods from a previous capture.**

**Errata reference: 13366**

**Fix/Workaround:**

The delay between two capture events must be longer than 3 APB clock periods + 3 generic clock periods.

**4 – When clearing STATUS.xxBUFV flag, SYNCBUSY is released before the register is restored to its appropriate value.**

**Errata reference: 15057**

**Fix/Workaround:**

To ensure that the register value is properly restored before updating this same register through xx or xxBUF with a new value, the STATUS.xxBUFV flag must be cleared successively two times.

**5 – Advance capture mode (CAPTMIN CAPTMAX LOCMIN LOCMAX DERIV0) doesn't work if an upper channel is not in one of these mode.**

**Example: when CC[0]=CAPTMIN, CC[1]=CAPTMAX, CC[2]=CAPTEN, and CC[3]=CAPTEN, CAPTMIN and CAPTMAX won't work.**

**Errata reference: 14817**

**Fix/Workaround:**

Basic capture mode must be set in lower channel and advance capture mode in upper channel.

Example: CC[0]=CAPTEN , CC[1]=CAPTEN , CC[2]=CAPTMIN, CC[3]=CAPTMAX

All capture will be done as expected.

**6 – When the circular buffer is enabled, an APB clock is requested to update the corresponding APB register. If all masters in the system (CPU, DMA) are disabled, the APB clock is never provided to the TCC, making the circular buffer feature not functional in standby sleep mode.**

**Errata reference: 12269**

**Fix/Workaround:**

Keep a master enabled in the system (enable DMA, or do not enable standby sleep mode when circular buffer is enabled).

**7 – In RAMP 2 mode with Fault keep, qualified and restart:**

**If a fault occurred at the end of the period during the qualified state, the switch to the next ramp can have two restarts.**

**Errata reference: 13262**

**Fix/Workaround:**

Avoid faults few cycles before the end or the beginning of a ramp.

## 47.1.2.17 CCL

**1 – The reset of the RS latch is not functional. The latch can only be cleared by disabling the LUT.**

**Errata reference: 14043**

**Fix/Workaround:**

None

## 47.1.2.18 ADC

**1 – Once set, the ADC.SWTRIG.START will not be cleared until the Microcontroller is reset.**

**Errata reference: 14094**

**Fix/Workaround:**

None

**2 – When window monitor is enabled and its output is 0, the ADC GCLK is kept running. Power consumption will be higher than expected in sleep modes**

**Errata reference: 14449**

**Fix/Workaround:**

None

**3 – The LSB of ADC result is stuck at zero, in unipolar mode for 8-bit and 10-bit resolution.**

**Errata reference: 14431**

**Fix/Workaround:**

Use 12-bit resolution and take only least 8 bits or 10 bits, if necessary.

**4 – If a synchronized event is received during an ADC conversion, the ADC will not acknowledge the event, causing a stall of the event channel.**

**Errata reference: 14795**

**Fix/Workaround:**

When using events with the ADC, only the asynchronous path from the Event System must be used.

## 47.1.2.19 PTC

**1 – The PTC generic clock is always requested during standby when RUNSTDBY is set to one. Power consumption will be higher if the PTC is enabled during standby sleep mode even if no conversion is on-going.**

**Errata reference: 14370**

**Fix/workaround**

**Disable PTC in standby mode to reduce power consumption**

## 47.1.3 Die Revision C

### 47.1.3.1 AC

**1 – Low power mode (COMPCTRLn.SPEED = 0x0) with Hysteresis enabled (COMPCTRLn.HYSTEN = 0x1) may result in undesired behavior of the AC.**

**Errata reference: 15714**

**Fix/Workaround:**

Do not use AC Low Power mode (COMPCTRLn.SPEED = 0x0) and hysteresis (COMPCTRLn.HYSTEN = 0x1) together. Use only one of these features to avoid incorrect AC behavior.

### 47.1.3.2 FDPLL

**1 – When changing on-the-fly the FDPLL ratio in DPLLnRATIO register, STATUS.DPLLnLDRTO will not be set when the ratio update will be completed.**

**Errata reference: 15753**

**Fix/Workaround:**

Wait for the interruption flag INTFLAG.DPLLnLDRTO instead.

## 47.1.3.3 PORT

**1 – PORT read/write attempts on non-implemented registers, including addresses beyond the last implemented register group (PA, PB,...) do not generate a PAC protection error.**

**Errata reference: 15611**

**Fix/Workaround:**

None

## 47.1.3.4 Device

**1 – The OSC48M accuracy cannot be reached for the whole VDD range.**

**Errata reference: 15342**

**Fix/Workaround:**

Rev A / B: none

Rev C: limited VDD range, according to the Electrical Characteristics chapter

Rev D: write OSCCTRL.CAL48M register, depending on the VDD range used.

**2 – When using DAC Output as Positive MUX Input Selection for the ADC, starting an ADC conversion results in noise on the DAC Output voltage and noisy ADC reading.**

**Errata reference: 14399**

**Fix/Workaround:**

Wire the DAC VOUT pin externally to a ADC AINx pin input. Select the corresponding ADC AINx pin as Positive MUX Input Selection.

## 47.1.3.5 FDPLL96M

**1 – The FDPLL96M exhibits high period jitter and is not suitable for accurate clocking. Accurate clocking is limited to 32MHz and below via XOSC.**

**Errata reference: 15174**

**Fix/Workaround:**

Connect a XTAL of up to 32MHz to XOSC for a high speed accurate clock source. OSC48M may be used for frequencies up to 48MHz when less accuracy is required.

## 47.1.3.6 EVSYS

**1 – The acknowledge between an event user and the EVSYS clears the CHSTATUS.CHBUSYn bit before this information is fully propagated in the EVSYS one GCLK\_EVSYS\_CHANNEL\_n clock cycle later. As a consequence, any generator event occurring on that channel before that extra GCLK\_EVSYS\_CHANNEL\_n clock cycle will trigger the overrun flag.**

**Errata reference: 14835**

**Fix/Workaround:**

For applications using event generators other than the software event, monitor the OVR flag.

For applications using the software event generator, wait one GCLK\_EVSYS\_CHANNEL\_n clock cycle after the CHSTATUS.CHBUSYn bit is cleared before issuing a software event.

**2 – Using synchronous, spurious overrun can appear with generic clock for the channel always on.**

**Errata reference: 14532**

**Fix/Workaround:**

- Request the generic clock on demand by setting the CHANNEL.ONDEMAND bit to one.
- No penalty is introduced.

## 47.1.3.7 DMAC

**1 – When using more than one DMA channel and if one of these DMA channels has a linked descriptor, a fetch error can appear on this channel.**

**Errata reference: 15670**

**Fix/Workaround:**

Do not use linked descriptors, make a software link instead:

Replace the channel which used linked descriptor by two channels DMA (with linked descriptor disabled) handled by two channels event system:

- DMA channel 0 transfer completion is able to send a conditional event for DMA channel 1 (via event system with configuration of BTCTRL.EVOSEL=BLOCK for channel 0 and configuration CHCTRLB.EVACT=CBLOCK for channel 1).
- On the transfer complete reception of the DMA channel 0, immediately re-enable the channel 0.
- Then DMA channel 1 transfer completion is able to send a conditional event for DMA channel 0 (via event system with configuration of BTCTRL.EVOSEL=BLOCK for channel 1 and configuration CHCTRLB.EVACT=CBLOCK for channel 0).
- On the transfer complete reception of the DMA channel 1, immediately re-enable the channel 1.
- The mechanism can be launched by sending a software event on the DMA channel 0.

**2 – When at least one channel using linked descriptors is already active, enabling another DMA channel (with or without linked descriptors) can result in a channel Fetch Error (FERR) or an incorrect descriptor fetch.**

**This happens if the channel number of the channel being enabled is lower than the channel already active.**

**Errata reference: 15683**

**Fix/Workaround:**

When enabling a DMA channel while other channels using linked descriptors are already active, the channel number of the new channel enabled must be greater than the other channel numbers.

## 47.1.3.8 EIC

**1 – Changing the NMI configuration(CONFIGn.SENSEx)on the fly may lead to a false NMI interrupt.**

**Errata reference: 15279**

**Fix/Workaround:**

Clear the NMIFLAG bit once the NMI has been modified.

**2 – When the EIC is configured to generate an interrupt on a low level or rising edge or both edges (CONFIGn.SENSEx) with the filter enabled (CONFIGn.FILTENx), a spurious flag might appear for the dedicated pin**

on the INTFLAG.EXTINT[x] register as soon as the EIC is enabled using CTRLA ENABLE bit.

**Errata reference: 15278**

**Fix/Workaround:**

Clear the INTFLAG bit once the EIC enabled and before enabling the interrupts.

## 47.1.3.9 NVMCTRL

**1 – The RWW EEPROM cache is not invalidated when performing write or erase operations. Reading RWWEE cached data can result in outdated data.**

**Errata reference: 14633**

**Fix/Workaround:**

When the RWW EEPROM Cache is on (CTRLB.CACHEDIS=0x2 or CTRLB.CACHEDIS=0x3) invalidate the cache by issuing the INVALL NVMCTRL command immediately after issuing a RWW EEPROM write or erase operation.

## 47.1.3.10 SERCOM

**1 – In USART autobaud mode, missing stop bits are not recognized as inconsistent sync (ISF) or framing (FERR) errors.**

**Errata reference: 13852**

**Fix/Workaround:**

None

## 47.1.3.11 TC

**1 – When clearing STATUS.xxBUFV flag, SYNCBUSY is released before the register is restored to its appropriate value.**

**Errata reference: 15056**

**Fix/Workaround:**

To ensure that the register value is properly restored before updating this same register through xx or xxBuf with a new value, the STATUS.xxBUFV flag must be cleared successively two times.

## 47.1.3.12 TCC

**1 – Using TCC in dithering mode with external retrigger events can lead to unexpected stretch of right aligned pulses, or shrink of left aligned pulses.**

**Errata reference: 15625**

**Fix/Workaround:**

Do not use retrigger events/actions when TCC is configured in dithering mode.

**2 – When clearing STATUS.xxBUFV flag, SYNCBUSY is released before the register is restored to its appropriate value.**

**Errata reference: 15057**

**Fix/Workaround:**

To ensure that the register value is properly restored before updating this same register through xx or xxBUF with a new value, the STATUS.xxBUFV flag must be cleared successively two times.

**3 – Advance capture mode (CAPTMIN CAPTMAX LOCMIN LOCMAX DERIV0) doesn't work if an upper channel is not in one of these mode.**



**Example: when CC[0]=CAPTMIN, CC[1]=CAPTMAX, CC[2]=CAPTEN, and CC[3]=CAPTEN, CAPTMIN and CAPTMAX won't work.**

**Errata reference: 14817**

**Fix/Workaround:**

Basic capture mode must be set in lower channel and advance capture mode in upper channel.

Example: CC[0]=CAPTEN , CC[1]=CAPTEN , CC[2]=CAPTMIN, CC[3]=CAPTMAX

All capture will be done as expected.

## 47.1.3.13 ADC

**1 – If a synchronized event is received during an ADC conversion, the ADC will not acknowledge the event, causing a stall of the event channel.**

**Errata reference: 14795**

**Fix/Workaround:**

When using events with the ADC, only the asynchronous path from the Event System must be used.

## 47.1.4 Die Revision D

### 47.1.4.1 AC

**1 – Low power mode (COMPCTRLn.SPEED = 0x0) with Hysteresis enabled (COMPCTRLn.HYSTEN = 0x1) may result in undesired behavior of the AC.**

**Errata reference: 15714**

**Fix/Workaround:**

Do not use AC Low Power mode (COMPCTRLn.SPEED = 0x0) and hysteresis (COMPCTRLn.HYSTEN = 0x1) together. Use only one of these features to avoid incorrect AC behavior.

### 47.1.4.2 FDPLL

**1 – When changing on-the-fly the FDPLL ratio in DPLLnRATIO register, STATUS.DPLLnLDRTO will not be set when the ratio update will be completed.**

**Errata reference: 15753**

**Fix/Workaround:**

Wait for the interruption flag INTFLAG.DPLLnLDRTO instead.

### 47.1.4.3 PORT

**1 – PORT read/write attempts on non-implemented registers, including addresses beyond the last implemented register group (PA, PB,...) do not generate a PAC protection error.**

**Errata reference: 15611**

**Fix/Workaround:**

None

### 47.1.4.4 Device

**1 – The OSC48M accuracy cannot be reached for the whole VDD range.**

**Errata reference: 15342**

**Fix/Workaround:**

Rev A / B: none

Rev C: limited VDD range, according to the Electrical Characteristics chapter  
Rev D: write OSCCTRL.CAL48M register, depending on the VDD range used.

**2 – When using DAC Output as Positive MUX Input Selection for the ADC, starting an ADC conversion results in noise on the DAC Output voltage and noisy ADC reading.**

**Errata reference: 14399**

**Fix/Workaround:**

Wire the DAC VOUT pin externally to a ADC AINx pin input. Select the corresponding ADC AINx pin as Positive MUX Input Selection.

## 47.1.4.5 EVSYS

**1 – The acknowledge between an event user and the EVSYS clears the CHSTATUS.CHBUSYn bit before this information is fully propagated in the EVSYS one GCLK\_EVSYS\_CHANNEL\_n clock cycle later. As a consequence, any generator event occurring on that channel before that extra GCLK\_EVSYS\_CHANNEL\_n clock cycle will trigger the overrun flag.**

**Errata reference: 14835**

**Fix/Workaround:**

For applications using event generators other than the software event, monitor the OVR flag.

For applications using the software event generator, wait one GCLK\_EVSYS\_CHANNEL\_n clock cycle after the CHSTATUS.CHBUSYn bit is cleared before issuing a software event.

**2 – Using synchronous, spurious overrun can appear with generic clock for the channel always on.**

**Errata reference: 14532**

**Fix/Workaround:**

- Request the generic clock on demand by setting the CHANNEL.ONDEMAND bit to one.
- No penalty is introduced.

## 47.1.4.6 DMAC

**1 – When using more than one DMA channel and if one of these DMA channels has a linked descriptor, a fetch error can appear on this channel.**

**Errata reference: 15670**

**Fix/Workaround:**

Do not use linked descriptors, make a software link instead:

Replace the channel which used linked descriptor by two channels DMA (with linked descriptor disabled) handled by two channels event system:

- DMA channel 0 transfer completion is able to send a conditional event for DMA channel 1 (via event system with configuration of BTCTRL.EVOSEL=BLOCK for channel 0 and configuration CHCTRLB.EVACT=CBLOCK for channel 1).
- On the transfer complete reception of the DMA channel 0, immediately re-enable the channel 0.
- Then DMA channel 1 transfer completion is able to send a conditional event for DMA channel 0 (via event system with configuration of

BTCTRL.EVOSEL=BLOCK for channel 1 and configuration  
CHCTRLB.EVACT=CBLOCK for channel 0).

- On the transfer complete reception of the DMA channel 1, immediately re-enable the channel 1.
- The mechanism can be launched by sending a software event on the DMA channel 0.

**2 – When at least one channel using linked descriptors is already active, enabling another DMA channel (with or without linked descriptors) can result in a channel Fetch Error (FERR) or an incorrect descriptor fetch.**

**This happens if the channel number of the channel being enabled is lower than the channel already active.**

**Errata reference: 15683**

**Fix/Workaround:**

When enabling a DMA channel while other channels using linked descriptors are already active, the channel number of the new channel enabled must be greater than the other channel numbers.

#### 47.1.4.7 EIC

**1 – Changing the NMI configuration(CONFIGn.SENSEx)on the fly may lead to a false NMI interrupt.**

**Errata reference: 15279**

**Fix/Workaround:**

Clear the NMIFLAG bit once the NMI has been modified.

**2 – When the EIC is configured to generate an interrupt on a low level or rising edge or both edges (CONFIGn.SENSEx) with the filter enabled (CONFIGn.FILTENx), a spurious flag might appear for the dedicated pin on the INTFLAG.EXTINT[x] register as soon as the EIC is enabled using CTRLA ENABLE bit.**

**Errata reference: 15278**

**Fix/Workaround:**

Clear the INTFLAG bit once the EIC enabled and before enabling the interrupts.

#### 47.1.4.8 NVMCTRL

**1 – The RWW EEPROM cache is not invalidated when performing write or erase operations. Reading RWWEE cached data can result in outdated data.**

**Errata reference: 14633**

**Fix/Workaround:**

When the RWW EEPROM Cache is on (CTRLB.CACHEDIS=0x2 or CTRLB.CACHEDIS=0x3) invalidate the cache by issuing the INVAL NVMCTRL command immediately after issuing a RWW EEPROM write or erase operation.

#### 47.1.4.9 SERCOM

**1 – In USART autobaud mode, missing stop bits are not recognized as inconsistent sync (ISF) or framing (FERR) errors.**

**Errata reference: 13852**

**Fix/Workaround:**

None

## 47.1.4.10 TC

**1 – When clearing STATUS.xxBUFV flag, SYNCBUSY is released before the register is restored to its appropriate value.**

**Errata reference: 15056**

**Fix/Workaround:**

To ensure that the register value is properly restored before updating this same register through xx or xxBuf with a new value, the STATUS.xxBUFV flag must be cleared successively two times.

## 47.1.4.11 TCC

**1 – Using TCC in dithering mode with external retrigger events can lead to unexpected stretch of right aligned pulses, or shrink of left aligned pulses.**

**Errata reference: 15625**

**Fix/Workaround:**

Do not use retrigger events/actions when TCC is configured in dithering mode.

**2 – When clearing STATUS.xxBUFV flag, SYNCBUSY is released before the register is restored to its appropriate value.**

**Errata reference: 15057**

**Fix/Workaround:**

To ensure that the register value is properly restored before updating this same register through xx or xxBUF with a new value, the STATUS.xxBUFV flag must be cleared successively two times.

**3 – Advance capture mode (CAPTMIN CAPTMAX LOCMIN LOCMAX DERIV0) doesn't work if an upper channel is not in one of these mode.**

**Example: when CC[0]=CAPTMIN, CC[1]=CAPTMAX, CC[2]=CAPTEN, and CC[3]=CAPTEN, CAPTMIN and CAPTMAX won't work.**

**Errata reference: 14817**

**Fix/Workaround:**

Basic capture mode must be set in lower channel and advance capture mode in upper channel.

Example: CC[0]=CAPTEN , CC[1]=CAPTEN , CC[2]=CAPTMIN, CC[3]=CAPTMAX

All capture will be done as expected.

## 47.1.4.12 ADC

**1 – If a synchronized event is received during an ADC conversion, the ADC will not acknowledge the event, causing a stall of the event channel.**

**Errata reference: 14795**

**Fix/Workaround:**

When using events with the ADC, only the asynchronous path from the Event System must be used.

## 47.2 SAM C20N

The device variant (last letter of the ordering number) is independent of the die revision (DSU.DID.REVISION): The device variant denotes functional differences, whereas the die revision marks evolution of the die.

## 47.2.1 Die Revision A

### 47.2.1.1 AC

**1 – Analog pins are shared between PTC and AC module. This may result in PTC accuracy issues.**

**Errata reference: 15746**

**Fix/Workaround:**

In order to guarantee the accuracy of the PTC measurement when using these shared pins, configure the AC input to anything different from default configuration i.e. VDD scaler, DAC or Bandgap.

**2 – Low power mode (COMPCTRLn.SPEED = 0x0) with Hysteresis enabled (COMPCTRLn.HYSTEN = 0x1) may result in undesired behavior of the AC.**

**Errata reference: 15714**

**Fix/Workaround:**

Do not use AC Low Power mode (COMPCTRLn.SPEED = 0x0) and hysteresis (COMPCTRLn.HYSTEN = 0x1) together. Use only one of these features to avoid incorrect AC behavior.

### 47.2.1.2 FDPLL

**1 – When FDPLL ratio value in DPLLDRATIO register is changed on the fly, STATUS.DPLLLDRTO will not be set even though the ratio is updated.**

**Errata reference: 15753**

**Fix/Workaround:**

Monitor the INTFLAG.DPLLLDRTO instead of STATUS.DPLLLDRTO to get the status for DPLLDRATIO update.

### 47.2.1.3 PORT

**1 – PORT read/write attempts on non-implemented registers, including addresses beyond the last implemented register group (PA, PB,...) do not generate a PAC protection error.**

**Errata reference: 15611**

**Fix/Workaround:**

None

### 47.2.1.4 Device

**1 – DMA write access in standby mode (eg: during sleepwalking) may not work on some registers.**

**The impacted peripheral registers are:**

- RTC: COUNT

- SDADC: SWTRIG

**Errata reference: 15896**

**Fix/Workaround:**

Use idle sleep mode when using DMA write access to the impacted registers.

**2 – Driving PC10 to logic HIGH affects VDDCORE.**

**Errata reference: 15818**

**Fix/Workaround:**

Do not use pin PC10. Keep the default configuration for the pin. Connect externally PC10 to GND.

**3 – When using DAC Output as the Reference Selection for the SDADC, starting a SDADC conversion results in noise on the DAC Output voltage.**

**Errata reference: 14400**

**Fix/Workaround:**

Set the SDADC Reference Buffer On, by writing REFCTRL.ONREFBUF = 1.

## 47.2.1.5 DAC

**1 – When DAC.CTRLA.RUNSTDBY = 0 and DATABUF is written (not empty), if the device goes to standby sleep mode before a Start Conversion event, DAC.INTFLAG.EMPTY will be set after exit from sleep mode.**

**Errata reference: 16093**

**Fix/Workaround:**

After waking from standby mode, ignore and clear the flag DAC.INTFLAG.EMPTY.

## 47.2.1.6 DMAC

**1 – When using more than one DMA channel and if one of these DMA channels has a linked descriptor, a fetch error can appear on this channel.**

**Errata reference: 15670**

**Fix/Workaround:**

Do not use linked descriptors, make a software link instead:

Replace the channel which used linked descriptor by two channels DMA (with linked descriptor disabled) handled by two channels event system:

- DMA channel 0 transfer completion is able to send a conditional event for DMA channel 1 (via event system with configuration of BTCTRL.EVOSEL=BLOCK for channel 0 and configuration CHCTRLB.EVACT=CBLOCK for channel 1).
- On the transfer complete reception of the DMA channel 0, immediately re-enable the channel 0.
- Then DMA channel 1 transfer completion is able to send a conditional event for DMA channel 0 (via event system with configuration of BTCTRL.EVOSEL=BLOCK for channel 1 and configuration CHCTRLB.EVACT=CBLOCK for channel 0).
- On the transfer complete reception of the DMA channel 1, immediately re-enable the channel 1.
- The mechanism can be launched by sending a software event on the DMA channel 0.

**2 – When at least one channel using linked descriptors is already active, enabling another DMA channel (with or without linked descriptors) can result in a channel Fetch Error (FERR) or an incorrect descriptor fetch.**

**This happens if the channel number of the channel being enabled is lower than the channel already active.**

**Errata reference: 15683**

**Fix/Workaround:**

When enabling a DMA channel while other channels using linked descriptors are already active, the channel number of the new channel enabled must be greater than the other channel numbers.

## 47.2.1.7 EIC

**1 – When the asynchronous edge detection is enabled, and the system is in standby mode, only the first edge will be detected. The following edges are ignored until the system wakes up.**

**Errata reference: 15995**

**Fix/Workaround:**

Use the asynchronous edge detection with debouncer enabled. It is recommended to have the DPRESALER.PRESCALER and DPRESALER.TICKON settings such as to have the lowest frequency possible.

To reduce the power consumption, set the EIC GCLK frequency as low as possible or select the ULP32K clock (EIC CTRLA.CKSEL set).

**2 – When enabling EIC, SYNCBUSY.ENABLE is released before EIC is fully enabled. Edge detection can be done only after three cycles of the selected GCLK (GCLK\_EIC or CLK\_ULP32K).**

**Errata reference: 15969**

**Fix/Workaround:**

None.

## 47.2.1.8 NVMCTRL

**1 – The RWW EEPROM cache is not invalidated when performing write or erase operations. Reading RWWEE cached data can result in outdated data.**

**Errata reference: 14633**

**Fix/Workaround:**

When the RWW EEPROM Cache is on (CTRLB.CACHEDIS=0x2 or CTRLB.CACHEDIS=0x3) invalidate the cache by issuing the INVAL NVMCTRL command immediately after issuing a RWW EEPROM write or erase operation.

## 47.2.1.9 SERCOM

**1 – In USART autobaud mode, missing stop bits are not recognized as inconsistent sync (ISF) or framing (FERR) errors.**

**Errata reference: 13852**

**Fix/Workaround:**

None

## 47.2.1.10 TC

**1 – When clearing the STATUS.PERBUFV / STATUS.CCBUFx flag, SYNCBUSY flag is released before the PERBUF / CCBUFx register is restored to its appropriate value.**

**Errata reference: 15056**

**Fix/Workaround:**

Clear successively twice the STATUS.PERBUFV / STATUS.CCBUFx flag to ensure that the PERBUF / CCBUFx register value is properly restored before updating it.

## 47.2.1.11 TCC

**1 – Using TCC in dithering mode with external retrigger events can lead to unexpected stretch of right aligned pulses, or shrink of left aligned pulses.**

**Errata reference: 15625**

**Fix/Workaround:**

Do not use retrigger events/actions when TCC is configured in dithering mode.

## 47.2.1.12 ADC

**1 – ADC SYNCBUSY.SWTRIG get stuck to one after wakeup from standby sleep mode.**

**Errata reference: 16027**

**Fix/Workaround:**

Ignore ADC SYNCBUSY.SWTRIG status when waking up from standby sleep mode. ADC result can be read after INTFLAG.RESRDY is set. To start the next conversion, write a '1' to SWTRIG.START.

## 47.2.1.13 TSENS

**1 – When PAC Write-Protection is enabled for TSENS, writes to TSENS.CTRLB are not functional.**

**Errata reference: 15910**

**Fix/Workaround:**

Do not enable the PAC Write-Protection for TSENS.CTRLB or use the TSENS in free-running mode.



## 48. Revision History

### 48.1 Rev - 03/2017

<a href="#">Ordering Information</a>	<ul style="list-style-type: none"> <li>Removed space form the ordering codes.</li> </ul>
Introducing SAM C20N	<ul style="list-style-type: none"> <li>100-pin TQFP package option.</li> <li>More features: Eight TCs, eight SERCOMs</li> </ul>
<a href="#">CCL – Configurable Custom Logic</a>	<ul style="list-style-type: none"> <li><a href="#">LUTCTRL.INSELx</a>: Added ALT2TC at INSELx=0xA. For the ALT2TC options the LUT 0 to 3 mapping will be TC4,TC5,TC6,TC7. The ALT2TC is only applicable for SAM C20N.</li> </ul>
<a href="#">OSC32KCTRL – 32KHz Oscillators Controller</a>	<ul style="list-style-type: none"> <li><a href="#">XOSC32K.STARTUP[2:0]</a>: Table for start-up times updated.</li> </ul>
<a href="#">Electrical Characteristics 85°C (SAM C20J/G/E)</a>	<ul style="list-style-type: none"> <li><a href="#">Digital to Analog Converter (DAC) Characteristics</a>: Updated conditions and typical numbers for power consumption.</li> <li><a href="#">Digital Phase Locked Loop (DPLL) Characteristics</a>: Added typical characterization numbers.</li> <li><a href="#">48MHz RC Oscillator (OSC48M) Characteristics</a>: Updated T<sub>START</sub> values, updated note 4 and removed the condition.</li> </ul>
<a href="#">Electrical Characteristics 105°C (SAM C20J/G/E)</a>	<ul style="list-style-type: none"> <li><a href="#">Digital-to-Analog Converter (DAC) Characteristics</a>: Updated conditions and typical numbers for power consumption.</li> <li><a href="#">Digital Phase Locked Loop (DPLL) Characteristics</a>: Added typical characterization numbers.</li> <li><a href="#">48MHz RC Oscillator (OSC48M) Characteristics</a>: Updated T<sub>START</sub> values, updated note 4 and removed the condition.</li> </ul>
<a href="#">Electrical Characteristics 105°C (SAM C20N)</a>	<ul style="list-style-type: none"> <li>Electrical characterization data added for SAM C20.</li> </ul>
<a href="#">Schematic Checklist</a>	<ul style="list-style-type: none"> <li><a href="#">External Reset Circuit</a>: Updated schematic diagram and recommended pin connections.</li> </ul>

### 48.2 Rev J - 11/2016

<a href="#">SAM C20E/G/J</a>	<ul style="list-style-type: none"> <li>Added DMAC errata (reference 15670).</li> </ul>
------------------------------	--

## 48.3 Rev I - 09/2016

General	<ul style="list-style-type: none"> <li>Removed preliminary status from the datasheet.</li> </ul>
Ordering Information	<ul style="list-style-type: none"> <li><b>SAM C20J:</b> Added -UUT ordering codes for SAM C20J17 and SAM C20J18.</li> </ul>
Pinout	<ul style="list-style-type: none"> <li>Added pinout for the <b>WLCSP56</b> package.</li> </ul>
I/O Multiplexing and Considerations	<ul style="list-style-type: none"> <li><b>Multiplexed Signals:</b> VREFB removed from the reference (REF) column. This is not an option.</li> </ul>
OSCCTRL – Oscillators Controller	<ul style="list-style-type: none"> <li><b>48MHz Internal Oscillator (OSC48M) Operation:</b> Removed the sentence "Frequency selection must be done when OSC48M is disabled."</li> </ul>
SUPC – Supply Controller	<ul style="list-style-type: none"> <li>Removed references to backup domain.</li> </ul>
WDT – Watchdog Timer	<ul style="list-style-type: none"> <li>Removed references to backup domain.</li> </ul>
RTC – Real-Time Counter	<ul style="list-style-type: none"> <li><b>Clock/Calendar (Mode 2):</b> Updated description.</li> </ul>
DMAC – Direct Memory Access Controller	<ul style="list-style-type: none"> <li><b>Sleep Mode Operation:</b> Added information on behaviour of DMA channels with CHCTRLA.RUNSTDBY=0.</li> </ul>
SERCOM USART – SERCOM Universal Synchronous and Asynchronous Receiver and Transmitter	<ul style="list-style-type: none"> <li><b>LIN Master</b> section added.</li> <li><b>CTRLA.TXPO:</b> Row heading updated from RTS to RTS/TE.</li> <li><b>CTRLA.FORM:</b> Added LIN Master to FORM[3:0]=0x2. Added LIN Slave to FORM[3:0]=0x4.</li> <li><b>CTRLB.LINCMD[3:0]</b> bit group added</li> <li><b>CTRLC.GTIME:</b> Bitfield values removed.</li> </ul>
TC – Timer/Counter	<ul style="list-style-type: none"> <li><b>CTRLA.ENABLE</b> and <b>SWRST</b> bit description updated: Added "This bit is not enable protected."</li> </ul>
ADC – Analog-to-Digital Converter	<ul style="list-style-type: none"> <li><b>Reference Configuration:</b> Removed information on number of external and internal voltage references and supported voltage supply range. This information is replaced with references to the REFCTRL.REFSEL register bits and ADC characteristics for reference selection details and voltage ranges respectively.</li> </ul>
Electrical Characteristics 85°C (SAM C20J/G/E)	<ul style="list-style-type: none"> <li><b>Absolute Maximum Ratings:</b> VDD max updated from 5.5V to 6.1V.</li> <li><b>General Operating Ratings:</b> Updated note.</li> <li><b>Injection Current:</b> New section added.</li> <li><b>Power Consumption:</b> Standby typical values updated and maximum values added.</li> <li><b>Analog-to-Digital Converter (ADC) Characteristics:</b></li> </ul>

	<ul style="list-style-type: none"> <li>– Added Ts, sampling tile with DAC as input.</li> <li>– <a href="#">Analog-to-Digital Converter (ADC) Characteristics</a>: In the condition column REFCTRL.REFSEL is corrected to CTRLC.RESSEL.</li> <li>– <a href="#">Analog Comparator Characteristics</a>: Removed Hysteresis for COMPCTRLn.SPEED = 0x0 (low power), Updated IDDANS units from nA to <math>\mu</math>A and updated condition for IDDANA with voltage scaler disabled (COMPCTRLn.SPEED = 0x1 changed to 0x3).</li> <li>• <a href="#">Digital Phase Locked Loop (DPLL) Characteristics</a>: Updated values.</li> <li>• <a href="#">48MHz RC Oscillator (OSC48M) Characteristics</a>: Added note on the output frequency regarding accuracy for the WLCSP package.</li> </ul>
<a href="#">Electrical Characteristics 105°C (SAM C20J/G/E)</a>	<ul style="list-style-type: none"> <li>• <a href="#">Power Consumption</a>: Standby typical values updated and maximum values added.</li> <li>• <a href="#">NVM Characteristics</a>: New section added.</li> <li>• <a href="#">Analog Comparator (AC) Characteristics</a>: Updated IDDANA units from nA to <math>\mu</math>A and updated condition for IDD with voltage scaler disabled (COMPCTRLn.SPEED = 0x1 changed to 0x3).</li> <li>• <a href="#">Digital Phase Locked Loop (DPLL) Characteristics</a>: Characterization data added.</li> </ul>
<a href="#">Packaging Information</a>	<ul style="list-style-type: none"> <li>• Added package outline drawing (POD) for <a href="#">56-Ball WLCSP</a>.</li> </ul>
<a href="#">Schematic Checklist</a>	<ul style="list-style-type: none"> <li>• <a href="#">External Analog Reference Connections</a>: Recommended pin connections column updated.</li> <li>• External Reset Circuit: Updated description.</li> </ul>

## 48.4 Rev H - 05/2016

<a href="#">Product Mapping</a>	<p>AHB-APB Bridge B:</p> <ul style="list-style-type: none"> <li>• DMAC base address corrected from 0x41004400 to 0x4106000.</li> <li>• MTB base address corrected from 0x41004800 to 0x41008000.</li> <li>• Reserved space corrected from 0x41005000 to 0x41009000.</li> </ul>
<a href="#">Micro Trace Buffer</a>	<p>MTB base address corrected from 0x41006000 to 0x41008000.</p>

SUPC – Supply Controller	VDD Brown-Out Detector (BODVDD): Removed references to battery backup (VBAT) and voltage monitored bit (BODVDD.VMON).
ADC – Analog-to-Digital Converter	Updated formula to increase the resolution by n bits in <a href="#">Oversampling and Decimation</a> .
Electrical Characteristics 105°C (SAM C20J/G/E)	Added <a href="#">Analog Characteristics</a> .

## 48.5 Rev G - 04/2015

Ordering Information	Added <a href="#">Device Identification</a> .
I/O Multiplexing and Considerations	New sections added: <ul style="list-style-type: none"> <li>• <a href="#">SERCOM I2C Pins</a>: Information moved from the "Type" column in <a href="#">Table 7-2</a> into separate table.</li> <li>• Updated CCL column.</li> <li>• <a href="#">GPIO Clusters</a>: Moved from <a href="#">Absolute Maximum Ratings</a>.</li> <li>• <a href="#">TCC Configurations</a>: Moved from <a href="#">TCC – Timer/Counter for Control Applications</a>.</li> </ul>
Memories	<ul style="list-style-type: none"> <li>• Updated <a href="#">Table 10-4</a>.</li> <li>• Updated <a href="#">Table 10-1</a>.</li> </ul>
PAC - Peripheral Access Controller	Register bit correction: INTFLAGAHB, INTFLAGA, INTFLAGB, INTFLAGC, STATUSA, STATUSB and STATUSC
DSU - Device Service Unit	<a href="#">Table 14-6</a> updated: MBIST is not available when the device is protected from the external address space.
GCLK - Generic Clock Controller	<ul style="list-style-type: none"> <li>• <a href="#">Block Diagram</a>: GCLK_MAIN goes into the MCLK, not the PM.</li> <li>• <a href="#">Signal Description</a>: Available signals are GCLK_IO[7:0].</li> </ul>
MCLK – Main Clock	<ul style="list-style-type: none"> <li>• Updated block diagram in <a href="#">Selecting the Synchronous Clock Division Ratio</a>.</li> </ul>
OSCCTRL – Oscillators Controller	Added OSC48M Calibration (CAL48M) register added (only available for Rev D silicon).
SUPC – Supply Controller	<ul style="list-style-type: none"> <li>• Updated VREF.SEL bit selection table.</li> <li>• Removed references to BODCORE register and bit descriptions and updated description in <a href="#">VDDCORE Brown-Out Detector (BODCORE)</a>.</li> </ul>
PM – Power Manager	<ul style="list-style-type: none"> <li>• Sleep modes: Removed references to IDLE0 and IDLE1. Renamed IDLE2 to IDLE.</li> </ul>
DMAC – Direct Memory Access Controller	CTRL.CRCENABLE bit added in bit position 2.
NVMCTRL – Non-Volatile Memory Controller	CTRLB.CACHEDIS: Updated from one bit in position 18 to two bits in position 19:18. Updated bit description and bit value settings.

<a href="#">SERCOM SPI – SERCOM Serial Peripheral Interface</a>	<b>Features:</b> Updated references to serial clock speed in master and slave operation.
<a href="#">TC – Timer/Counter</a>	Added register property "Write-Synchronized" to the CCBUFx and PERBUF registers.
<a href="#">TCC – Timer/Counter for Control Applications</a>	<ul style="list-style-type: none"> <li>Updated number of TCC instances from one to three.</li> <li><b>Counter Operation:</b> 'Stop Command and Event Action' split into 'Stop Command' and 'Pause Event Action'</li> <li><b>Capture Operations:</b> Value 0 in CAPTMIN mode is captured only in down-counting mode.</li> <li><b>Ramp Operations:</b> RAMP2C Operation added.</li> <li><b>Compare Operations:</b> Reorganization of section.</li> <li>Corrected bit names in the WAVE register: CIRCCENx -&gt; CICCENx and CIRPEREN -&gt; CIPEREN.</li> </ul>
<a href="#">CCL – Configurable Custom Logic</a>	<ul style="list-style-type: none"> <li>Number of LUTCTRL registers changed from eight to four.</li> <li>Number of SEQCTRL registers changed from four to two.</li> </ul>
<a href="#">AC – Analog Comparators</a>	<b>COMPCTRL:</b> SPEED bit description updated. Values 0x1 and 0x2 is reserved.
<a href="#">DAC – Digital-to-Analog Converter</a>	Updated <b>DATA</b> register: DATA bits access corrected from read/write (R/W) to write (W).
<a href="#">Electrical Characteristics 85°C (SAM C20J/G/E)</a>	<ul style="list-style-type: none"> <li>Added electrical characteristics for 85°C.</li> <li><b>GPIO Clusters</b> moved to <a href="#">I/O Multiplexing and Considerations</a>.</li> </ul>
<a href="#">Electrical Characteristics 105°C (SAM C20J/G/E)</a>	<ul style="list-style-type: none"> <li>Added electrical characteristics for 105°C.</li> </ul>
<a href="#">Packaging Information</a>	Updated package drawings to include GPC, drawing no. and revision letter.
<a href="#">SAM C20E/G/J</a>	<ul style="list-style-type: none"> <li>Updated revision B errata: Added Errata reference 14497, 14633 and 15342.</li> <li>Added revision C errata.</li> <li>Added revision D errata.</li> </ul>

## 48.6 Rev F - 02/2015

<a href="#">Configuration Summary</a>	Number of PTC X and Y lines updated for SAM C20G and SAM C20E.
<a href="#">DSU - Device Service Unit</a>	<b>ADDR:</b> Added AMOD bits.
<a href="#">SUPC – Supply Controller</a>	<b>Debug Operation:</b> Updated description.
References to oscillator OSC16M removed and replaced with OSC48M:	<ul style="list-style-type: none"> <li><b>Clock Distribution:</b> Block diagram updated.</li> <li><b>Block Diagram:</b> OSCM16M replaced by OSC48M. DFLL48M removed.</li> </ul>

	<ul style="list-style-type: none"> <li>• GENCTRLn.SRC[4:0]: Value 0x6 description updated.</li> <li>• <a href="#">48MHz Internal Oscillator (OSC48M) Operation</a>.</li> </ul>
<a href="#">EVSYS – Event System</a>	<a href="#">CTRLA</a> : Note added to CTRLA.SWRST bit description.
<a href="#">DMAC – Direct Memory Access Controller</a>	Updated description of the <a href="#">PRICTRL0.LVLPRIn</a> bits.
<a href="#">TC – Timer/Counter</a>	Updated section <a href="#">Clocks</a> : The TC bus clocks (CLK_TCx_APB) can be enabled and disabled in the <i>Main Clock Module (MCLK)</i> (not the Power Manager).
<a href="#">AC – Analog Comparators</a>	<p>Removed references to multiple level hysteresis. Levels are not available, only on or off:</p> <ul style="list-style-type: none"> <li>• <a href="#">Features</a>: Selectable hysteresis updated from "4-levels" or off to "on or off".</li> <li>• <a href="#">Comparator Configuration</a>: Removed references to COMPCTRLx.HYST bits.</li> <li>• <a href="#">Input Hysteresis</a>: Removed references to COMPCTRLx.HYST bits.</li> <li>• Register Summary: Removed the COMPCTRLx.HYST bits.</li> <li>• <a href="#">COMPCTRL</a>: Removed the HYST bits.</li> </ul>

## 48.7 Rev E - 12/2015

<a href="#">Configuration Summary</a>	<ul style="list-style-type: none"> <li>• Corrected memory sizes.</li> <li>• Number of ADC channels corrected.</li> <li>• Number of TCC instances corrected from three to one.</li> </ul>
<a href="#">Ordering Information</a>	<ul style="list-style-type: none"> <li>• Introduced 105°C ordering codes.</li> <li>• Corrected package type from QFN48 to TQFP48 for ATSAM C20G16A-AUT.</li> </ul>
<a href="#">DSU - Device Service Unit</a>	Bit CTRL.CRC is write-only.
<a href="#">NVMCTRL – Non-Volatile Memory Controller</a>	Updated description in <a href="#">NVM Write</a> : Removed reference to default MANW value. This is covered in the <a href="#">CTRLB.MANW</a> bit description.
<a href="#">DMAC – Direct Memory Access Controller</a>	Added note in <a href="#">Sleep Mode Operation</a> .

CCL – Configurable Custom Logic	Removed oscillator related sub sections from <a href="#">Sequential Logic</a> .
SERCOM USART – SERCOM Universal Synchronous and Asynchronous Receiver and Transmitter	<ul style="list-style-type: none"> <li>Added RS485 to the TXPO bit description in the <a href="#">CTRLA</a> register.</li> </ul>

## 48.8 Rev D - 09/2015

SERCOM USART – SERCOM Universal Synchronous and Asynchronous Receiver and Transmitter	<ul style="list-style-type: none"> <li>Updated formula in the <a href="#">RXPL</a> register.</li> </ul>
SAM C20E/G/J	<ul style="list-style-type: none"> <li>Reinserted errata section which was missing from datasheet rev C.</li> </ul>

## 48.9 Rev C - 09/2015

General	Editorial updates.
<a href="#">DMAC – Direct Memory Access Controller</a>	<ul style="list-style-type: none"> <li>Updated number of bits in the SWTRIGCTRL, INTSTATUS, BUSYCH and PENDCH registers (Related to number of DMA channels available).</li> </ul>
<a href="#">PORT - I/O Pin Controller</a>	<ul style="list-style-type: none"> <li>Functional Description: Overview diagram updated.</li> </ul>
<a href="#">ADC – Analog-to-Digital Converter</a>	<ul style="list-style-type: none"> <li>Block Diagram: Renamed ADC input signals from ADC to AIN.</li> <li>Signal Description: Renamed ADC signal to AIN</li> </ul>
<a href="#">PTC - Peripheral Touch Controller</a>	<ul style="list-style-type: none"> <li>Block Diagram updated.</li> <li>Section Self-capacitance Sensor Arrangement updated.</li> </ul>

## 48.10 Rev B - 06/2015

<a href="#">Ordering Information</a>	<ul style="list-style-type: none"> <li>Remove carrier type Tray option.</li> </ul>
--------------------------------------	--

## 48.11 Rev A - 04/2015

Initial revision.
-------------------

## The Microchip Web Site

---

Microchip provides online support via our web site at <http://www.microchip.com/>. This web site is used as a means to make files and information easily available to customers. Accessible by using your favorite Internet browser, the web site contains the following information:

- **Product Support** – Data sheets and errata, application notes and sample programs, design resources, user's guides and hardware support documents, latest software releases and archived software
- **General Technical Support** – Frequently Asked Questions (FAQ), technical support requests, online discussion groups, Microchip consultant program member listing
- **Business of Microchip** – Product selector and ordering guides, latest Microchip press releases, listing of seminars and events, listings of Microchip sales offices, distributors and factory representatives

## Customer Change Notification Service

---

Microchip's customer notification service helps keep customers current on Microchip products. Subscribers will receive e-mail notification whenever there are changes, updates, revisions or errata related to a specified product family or development tool of interest.

To register, access the Microchip web site at <http://www.microchip.com/>. Under "Support", click on "Customer Change Notification" and follow the registration instructions.

## Customer Support

---

Users of Microchip products can receive assistance through several channels:

- Distributor or Representative
- Local Sales Office
- Field Application Engineer (FAE)
- Technical Support

Customers should contact their distributor, representative or Field Application Engineer (FAE) for support. Local sales offices are also available to help customers. A listing of sales offices and locations is included in the back of this document.

Technical support is available through the web site at: <http://www.microchip.com/support>



## Product Identification System

To order or obtain information, e.g., on pricing or delivery, refer to the factory or the listed sales office.



### Note:

1. Tape and Reel identifier only appears in the catalog part number description. This identifier is used for ordering purposes and is not printed on the device package. Check with your Microchip Sales Office for package availability with the Tape and Reel option.
2. Small form-factor packaging options may be available. Please check <http://www.microchip.com/packaging> for small-form factor package availability, or contact your local Sales Office.

## Microchip Devices Code Protection Feature

Note the following details of the code protection feature on Microchip devices:

- Microchip products meet the specification contained in their particular Microchip Data Sheet.
- Microchip believes that its family of products is one of the most secure families of its kind on the market today, when used in the intended manner and under normal conditions.
- There are dishonest and possibly illegal methods used to breach the code protection feature. All of these methods, to our knowledge, require using the Microchip products in a manner outside the operating specifications contained in Microchip's Data Sheets. Most likely, the person doing so is engaged in theft of intellectual property.
- Microchip is willing to work with the customer who is concerned about the integrity of their code.
- Neither Microchip nor any other semiconductor manufacturer can guarantee the security of their code. Code protection does not mean that we are guaranteeing the product as "unbreakable."

Code protection is constantly evolving. We at Microchip are committed to continuously improving the code protection features of our products. Attempts to break Microchip's code protection feature may be a

violation of the Digital Millennium Copyright Act. If such acts allow unauthorized access to your software or other copyrighted work, you may have a right to sue for relief under that Act.

## Legal Notice

---

Information contained in this publication regarding device applications and the like is provided only for your convenience and may be superseded by updates. It is your responsibility to ensure that your application meets with your specifications. MICROCHIP MAKES NO REPRESENTATIONS OR WARRANTIES OF ANY KIND WHETHER EXPRESS OR IMPLIED, WRITTEN OR ORAL, STATUTORY OR OTHERWISE, RELATED TO THE INFORMATION, INCLUDING BUT NOT LIMITED TO ITS CONDITION, QUALITY, PERFORMANCE, MERCHANTABILITY OR FITNESS FOR PURPOSE. Microchip disclaims all liability arising from this information and its use. Use of Microchip devices in life support and/or safety applications is entirely at the buyer's risk, and the buyer agrees to defend, indemnify and hold harmless Microchip from any and all damages, claims, suits, or expenses resulting from such use. No licenses are conveyed, implicitly or otherwise, under any Microchip intellectual property rights unless otherwise stated.

## Trademarks

---

The Microchip name and logo, the Microchip logo, dsPIC, FlashFlex, flexPWR, JukeBlox, KEELOQ, KEELOQ logo, Klear, LANCheck, MediaLB, MOST, MOST logo, MPLAB, OptoLyzer, PIC, PICSTART, PIC32 logo, RightTouch, SpyNIC, SST, SST Logo, SuperFlash and UNI/O are registered trademarks of Microchip Technology Incorporated in the U.S.A. and other countries.

The Embedded Control Solutions Company and mTouch are registered trademarks of Microchip Technology Incorporated in the U.S.A.

Analog-for-the-Digital Age, BodyCom, chipKIT, chipKIT logo, CodeGuard, dsPICDEM, dsPICDEM.net, ECAN, In-Circuit Serial Programming, ICSP, Inter-Chip Connectivity, KlearNet, KlearNet logo, MiWi, MPASM, MPF, MPLAB Certified logo, MPLIB, MPLINK, MultiTRAK, NetDetach, Omniscient Code Generation, PICDEM, PICDEM.net, PICkit, PICtail, RightTouch logo, REAL ICE, SQI, Serial Quad I/O, Total Endurance, TSHARC, USBCheck, VariSense, ViewSpan, WiperLock, Wireless DNA, and ZENA are trademarks of Microchip Technology Incorporated in the U.S.A. and other countries.

SQTP is a service mark of Microchip Technology Incorporated in the U.S.A.

Silicon Storage Technology is a registered trademark of Microchip Technology Inc. in other countries.

GestIC is a registered trademark of Microchip Technology Germany II GmbH & Co. KG, a subsidiary of Microchip Technology Inc., in other countries.

All other trademarks mentioned herein are property of their respective companies.

© 2015, Microchip Technology Incorporated, Printed in the U.S.A., All Rights Reserved.

ISBN: 978-1-5224-1497-1

## Quality Management System Certified by DNV

---

### ISO/TS 16949

Microchip received ISO/TS-16949:2009 certification for its worldwide headquarters, design and wafer fabrication facilities in Chandler and Tempe, Arizona; Gresham, Oregon and design centers in California and India. The Company's quality system processes and procedures are for its PIC<sup>®</sup> MCUs and dsPIC<sup>®</sup> DSCs, KEELOQ<sup>®</sup> code hopping devices, Serial EEPROMs, microperipherals, nonvolatile memory and

analog products. In addition, Microchip's quality system for the design and manufacture of development systems is ISO 9001:2000 certified.

## Worldwide Sales and Service

AMERICAS	ASIA/PACIFIC	ASIA/PACIFIC	EUROPE
<p><b>Corporate Office</b> 2355 West Chandler Blvd. Chandler, AZ 85224-6199 Tel: 480-792-7200 Fax: 480-792-7277 Technical Support: <a href="http://www.microchip.com/support">http://www.microchip.com/support</a> Web Address: <a href="http://www.microchip.com">www.microchip.com</a></p> <p><b>Atlanta</b> Duluth, GA Tel: 678-957-9614 Fax: 678-957-1455</p> <p><b>Austin, TX</b> Tel: 512-257-3370</p> <p><b>Boston</b> Westborough, MA Tel: 774-760-0087 Fax: 774-760-0088</p> <p><b>Chicago</b> Itasca, IL Tel: 630-285-0071 Fax: 630-285-0075</p> <p><b>Dallas</b> Addison, TX Tel: 972-818-7423 Fax: 972-818-2924</p> <p><b>Detroit</b> Novi, MI Tel: 248-848-4000</p> <p><b>Houston, TX</b> Tel: 281-894-5983</p> <p><b>Indianapolis</b> Noblesville, IN Tel: 317-773-8323 Fax: 317-773-5453 Tel: 317-536-2380</p> <p><b>Los Angeles</b> Mission Viejo, CA Tel: 949-462-9523 Fax: 949-462-9608 Tel: 951-273-7800</p> <p><b>Raleigh, NC</b> Tel: 919-844-7510</p> <p><b>New York, NY</b> Tel: 631-435-6000</p> <p><b>San Jose, CA</b> Tel: 408-735-9110 Tel: 408-436-4270</p> <p><b>Canada - Toronto</b> Tel: 905-695-1980 Fax: 905-695-2078</p>	<p><b>Asia Pacific Office</b> Suites 3707-14, 37th Floor Tower 6, The Gateway Harbour City, Kowloon</p> <p><b>Hong Kong</b> Tel: 852-2943-5100 Fax: 852-2401-3431</p> <p><b>Australia - Sydney</b> Tel: 61-2-9868-6733 Fax: 61-2-9868-6755</p> <p><b>China - Beijing</b> Tel: 86-10-8569-7000 Fax: 86-10-8528-2104</p> <p><b>China - Chengdu</b> Tel: 86-28-8665-5511 Fax: 86-28-8665-7889</p> <p><b>China - Chongqing</b> Tel: 86-23-8980-9588 Fax: 86-23-8980-9500</p> <p><b>China - Dongguan</b> Tel: 86-769-8702-9880</p> <p><b>China - Guangzhou</b> Tel: 86-20-8755-8029</p> <p><b>China - Hangzhou</b> Tel: 86-571-8792-8115 Fax: 86-571-8792-8116</p> <p><b>China - Hong Kong SAR</b> Tel: 852-2943-5100 Fax: 852-2401-3431</p> <p><b>China - Nanjing</b> Tel: 86-25-8473-2460 Fax: 86-25-8473-2470</p> <p><b>China - Qingdao</b> Tel: 86-532-8502-7355 Fax: 86-532-8502-7205</p> <p><b>China - Shanghai</b> Tel: 86-21-3326-8000 Fax: 86-21-3326-8021</p> <p><b>China - Shenyang</b> Tel: 86-24-2334-2829 Fax: 86-24-2334-2393</p> <p><b>China - Shenzhen</b> Tel: 86-755-8864-2200 Fax: 86-755-8203-1760</p> <p><b>China - Wuhan</b> Tel: 86-27-5980-5300 Fax: 86-27-5980-5118</p> <p><b>China - Xian</b> Tel: 86-29-8833-7252 Fax: 86-29-8833-7256</p>	<p><b>China - Xiamen</b> Tel: 86-592-2388138 Fax: 86-592-2388130</p> <p><b>China - Zhuhai</b> Tel: 86-756-3210040 Fax: 86-756-3210049</p> <p><b>India - Bangalore</b> Tel: 91-80-3090-4444 Fax: 91-80-3090-4123</p> <p><b>India - New Delhi</b> Tel: 91-11-4160-8631 Fax: 91-11-4160-8632</p> <p><b>India - Pune</b> Tel: 91-20-3019-1500</p> <p><b>Japan - Osaka</b> Tel: 81-6-6152-7160 Fax: 81-6-6152-9310</p> <p><b>Japan - Tokyo</b> Tel: 81-3-6880-3770 Fax: 81-3-6880-3771</p> <p><b>Korea - Daegu</b> Tel: 82-53-744-4301 Fax: 82-53-744-4302</p> <p><b>Korea - Seoul</b> Tel: 82-2-554-7200 Fax: 82-2-558-5932 or 82-2-558-5934</p> <p><b>Malaysia - Kuala Lumpur</b> Tel: 60-3-6201-9857 Fax: 60-3-6201-9859</p> <p><b>Malaysia - Penang</b> Tel: 60-4-227-8870 Fax: 60-4-227-4068</p> <p><b>Philippines - Manila</b> Tel: 63-2-634-9065 Fax: 63-2-634-9069</p> <p><b>Singapore</b> Tel: 65-6334-8870 Fax: 65-6334-8850</p> <p><b>Taiwan - Hsin Chu</b> Tel: 886-3-5778-366 Fax: 886-3-5770-955</p> <p><b>Taiwan - Kaohsiung</b> Tel: 886-7-213-7830</p> <p><b>Taiwan - Taipei</b> Tel: 886-2-2508-8600 Fax: 886-2-2508-0102</p> <p><b>Thailand - Bangkok</b> Tel: 66-2-694-1351 Fax: 66-2-694-1350</p>	<p><b>Austria - Wels</b> Tel: 43-7242-2244-39 Fax: 43-7242-2244-393</p> <p><b>Denmark - Copenhagen</b> Tel: 45-4450-2828 Fax: 45-4485-2829</p> <p><b>Finland - Espoo</b> Tel: 358-9-4520-820</p> <p><b>France - Paris</b> Tel: 33-1-69-53-63-20 Fax: 33-1-69-30-90-79</p> <p><b>France - Saint Cloud</b> Tel: 33-1-30-60-70-00</p> <p><b>Germany - Garching</b> Tel: 49-8931-9700</p> <p><b>Germany - Haan</b> Tel: 49-2129-3766400</p> <p><b>Germany - Heilbronn</b> Tel: 49-7131-67-3636</p> <p><b>Germany - Karlsruhe</b> Tel: 49-721-625370</p> <p><b>Germany - Munich</b> Tel: 49-89-627-144-0 Fax: 49-89-627-144-44</p> <p><b>Germany - Rosenheim</b> Tel: 49-8031-354-560</p> <p><b>Israel - Ra'anana</b> Tel: 972-9-744-7705</p> <p><b>Italy - Milan</b> Tel: 39-0331-742611 Fax: 39-0331-466781</p> <p><b>Italy - Padova</b> Tel: 39-049-7625286</p> <p><b>Netherlands - Druen</b> Tel: 31-416-690399 Fax: 31-416-690340</p> <p><b>Norway - Trondheim</b> Tel: 47-7289-7561</p> <p><b>Poland - Warsaw</b> Tel: 48-22-3325737</p> <p><b>Romania - Bucharest</b> Tel: 40-21-407-87-50</p> <p><b>Spain - Madrid</b> Tel: 34-91-708-08-90 Fax: 34-91-708-08-91</p> <p><b>Sweden - Gothenburg</b> Tel: 46-31-704-60-40</p> <p><b>Sweden - Stockholm</b> Tel: 46-8-5090-4654</p> <p><b>UK - Wokingham</b> Tel: 44-118-921-5800 Fax: 44-118-921-5820</p>

# Mouser Electronics

Authorized Distributor

Click to View Pricing, Inventory, Delivery & Lifecycle Information:

## Microchip:

[ATSAMC20G16A-MNT](#) [ATSAMC20J15A-MUT](#) [ATSAMC20J17A-MUT](#) [ATSAMC20G17A-MNT](#) [ATSAMC20G18A-MUT](#) [ATSAMC20J16A-MNT](#) [ATSAMC20G15A-AUT](#) [ATSAMC20G18A-AUT](#) [ATSAMC20E17A-AUT](#)  
[ATSAMC20E15A-AUT](#) [ATSAMC20G16A-ANT](#) [ATSAMC20G18A-MNT](#) [ATSAMC20E16A-AUT](#) [ATSAMC20G17A-AUT](#)  
[ATSAMC20E15A-ANT](#) [ATSAMC20E15A-MNT](#) [ATSAMC20G16A-AUT](#) [ATSAMC20E17A-MUT](#) [ATSAMC20J16A-ANT](#)  
[ATSAMC20J17A-AUT](#) [ATSAMC20E15A-MUT](#) [ATSAMC20J15A-ANT](#) [ATSAMC20J17A-MNT](#) [ATSAMC20J17A-ANT](#)  
[ATSAMC20G17A-ANT](#) [ATSAMC20J16A-AUT](#) [ATSAMC20J18A-MNT](#) [ATSAMC20J15A-MNT](#) [ATSAMC20J15A-AUT](#)  
[ATSAMC20G15A-ANT](#) [ATSAMC20E16A-ANT](#) [ATSAMC20E17A-MNT](#) [ATSAMC20G16A-MUT](#) [ATSAMC20E18A-MNT](#)  
[ATSAMC20E16A-MNT](#) [ATSAMC20G15A-MNT](#) [ATSAMC20J18A-ANT](#) [ATSAMC20G15A-MUT](#) [ATSAMC20J18A-MUT](#) [ATSAMC20E17A-ANT](#) [ATSAMC20J16A-MUT](#) [ATSAMC20E18A-ANT](#) [ATSAMC20G18A-ANT](#)  
[ATSAMC20G17A-MUT](#) [ATSAMC20E16A-MUT](#) [ATSAMC20E18A-MUT](#) [ATSAMC20N17A-ANT](#) [ATSAMC20N18A-ANT](#)  
[ATSAMC20J17A-UUT](#) [ATSAMC20J18A-UUT](#)



Компания «ЭлектроПласт» предлагает заключение долгосрочных отношений при поставках импортных электронных компонентов на взаимовыгодных условиях!

Наши преимущества:

- Оперативные поставки широкого спектра электронных компонентов отечественного и импортного производства напрямую от производителей и с крупнейших мировых складов;
- Поставка более 17-ти миллионов наименований электронных компонентов;
- Поставка сложных, дефицитных, либо снятых с производства позиций;
- Оперативные сроки поставки под заказ (от 5 рабочих дней);
- Экспресс доставка в любую точку России;
- Техническая поддержка проекта, помощь в подборе аналогов, поставка прототипов;
- Система менеджмента качества сертифицирована по Международному стандарту ISO 9001;
- Лицензия ФСБ на осуществление работ с использованием сведений, составляющих государственную тайну;
- Поставка специализированных компонентов (Xilinx, Altera, Analog Devices, Intersil, Interpoint, Microsemi, Aeroflex, Peregrine, Syfer, Eurofarad, Texas Instrument, Miteq, Cobham, E2V, MA-COM, Hittite, Mini-Circuits, General Dynamics и др.);

Помимо этого, одним из направлений компании «ЭлектроПласт» является направление «Источники питания». Мы предлагаем Вам помощь Конструкторского отдела:

- Подбор оптимального решения, техническое обоснование при выборе компонента;
- Подбор аналогов;
- Консультации по применению компонента;
- Поставка образцов и прототипов;
- Техническая поддержка проекта;
- Защита от снятия компонента с производства.



#### Как с нами связаться

**Телефон:** 8 (812) 309 58 32 (многоканальный)

**Факс:** 8 (812) 320-02-42

**Электронная почта:** [org@eplast1.ru](mailto:org@eplast1.ru)

**Адрес:** 198099, г. Санкт-Петербург, ул. Калинина, дом 2, корпус 4, литера А.