

Description

E-T-A's ESX10 electronic circuit protector is only 12.5 mm wide and selectively protects all DC 24 V load circuits, thereby increasing the uptime of machines and systems. This is achieved by a combination of active current limitation in the event of a short circuit and overload disconnection typically from 1.1 times rated current. The ESX10 responds faster than frequently used DC 24 V switch mode power supplies without tripping fast and thus prevents disastrous voltage dips of the supply. It works with a single trip curve for all loads. Even capacitive loads up to 75,000 µF can be handled very easily. The device is available in fixed current ratings from 0.5 A to 12 A and with optional control inputs. The integral fail-safe element (fuse) is adjusted to the circuit protectors rated current and can thus very easily be synchronised with the wired cable cross section. This makes planning much easier.

US patent number: US 6,490,141 B2



ESX10

Features

- Plug-in mounting on power distribution modules 17plus, 18plus and SVSxx
- Active linear current limitation
- Capacitive loads up to 75,000 µF
- Fixed current ratings 0.5 A...12 A
- Approvals: UL, CSA, DNV GL
- OPTION: Control inputs, signalling
- OPTION: ATEX and IECEx approval

Your benefits

- Increases machine uptime through clear failure detection and stable power supply
- Reduces downtimes through quick fault resolution
- Simplifies planning through clear sizes and ratings
- Saves costs and time through fast and flexible plug-in mounting

Preferred types – for more details on all configurations please see order numbering code

Preferred types are E-T-A products most frequently used by E-T-A customers. We manufacture E-T-A preferred types in particularly high

volumes. Our preferred types are supplied at shorter lead times than non-standard versions.

Preferred types	Preferred ratings (A)							
	1	2	3	4	6	8	10	12
ESX10								
ESX10-103-DC24V	x	x	x	x	x	x	x	x

Approvals



Information online

The current data sheet is available on our website:
www.e-t-a.de/d355

Compliances



Technical data ($T_{\text{ambient}} = 25\text{ }^{\circ}\text{C}$, operating voltage $U_S = \text{DC } 24\text{ V}$)

Operating data

Operating voltage U_S	DC 24 V (18...32 V)
Current rating I_N	fixed current ratings: 0.5 A, 1 A, 2 A, 3 A, 4 A, 6 A, 8 A, 10 A, 12 A
Closed current I_0	ON condition: typically 20...30 mA depending on signal output
Status indication by means of	<ul style="list-style-type: none"> ● multicolour LED: GREEN: unit is ON, power-MOSFET is switched on - status output SF ON, supplies +DC 24 V ORANGE: in the event of overload or short circuit until electronic disconnection RED: - unit electronically disconnected - load circuit/Power-MOSFET OFF OFF: - manually switched off (S1 = OFF) or device is dead - undervoltage ($U_S < 8\text{ V}$) - after switch-on till the end of the delay period ● status output SF (option) ● potential-free signal contact F (option) ● ON/OFF/ condition of switch S1

Load circuit

Load output	Power-MOSFET switching output (high side switch)
Overload disconnection	typically $1.1 \times I_N$ (1.05...1.35 $\times I_N$)
Short-circuit current I_k	active current limitation (see table 1)
Trip time for electronic disconnection	see time/current characteristics typically 3 s at $I_{\text{load}} > 1.1 \times I_N$ typically 3 s...100 ms at $I_{\text{load}} > 1.8 \times I_N$ (or $1.5 \times I_N/1.3 \times I_N$)
Temperature disconnection	internal temperature monitoring with electronic disconnection
Low voltage monitoring load output	with hysteresis, no reset necessary load "OFF" at $U_S < 8\text{ V}$
Starting delay t_{start}	typically 0.5 sec after every switch-on and after applying U_S
Disconnection of load circuit	electronic disconnection
Free-wheeling circuit	external free-wheeling diode recommended with inductive load

Several load outputs must not be connected in parallel

Status output SF ESX10-104/-124

Electrical data	plus-switching signal output, connects U_S to terminal 12 of module 17plus nominal data: DC 24 V / max. 0.2 A (short circuit proof) status output is internally connected to GND with a 10 kOhm resistor
Status OUT	ESX10-104/-106/ -124 (signal status OUT), at $U_S = +24\text{ V}$ $+24\text{ V} = \text{S1 is ON, load output connected}$ $0\text{ V} = \text{S1 is ON, load output blocked and/or switch S1 is OFF}$
Status $\overline{\text{OUT}}$	ESX10-127 (signal status OUT inverted), at $U_S = +24\text{ V}$ $+24\text{ V} = \text{S1 is ON, load output blocked, red LED lighted}$ $0\text{ V} = \text{S1 is ON, load output connected through and/or switch S1 is in OFF position}$
OFF condition	0 V level at status output when: <ul style="list-style-type: none"> ● switch S1 is in ON position, but device is still in switch-on delay ● switch S1 is OFF, or control signal OFF, device is switched off ● no operating voltage U_S

Technical data ($T_{\text{ambient}} = 25\text{ }^{\circ}\text{C}$, operating voltage $U_S = \text{DC } 24\text{ V}$)

Signal output F

ESX10-103/-115/-125

Electrical data	potential-free signal contact max. DC 30 V/0.5 A, min. 10 V/10 mA
ON condition LED green	voltage U_S applied, switch S1 is in ON position no overload, no short circuit
OFF condition LED off	<ul style="list-style-type: none"> ● device switched off (switch S1 is in OFF position) ● no voltage U_S applied
Fault condition LED orange	overload condition $> 1.1 \times I_N$ up to electronic disconnection
Fault condition LED red	electronic disconnection upon overload or short circuit device switched off with control signal (switch S1 is in ON position)
ESX10-101	single signal, make contact contact SC/SO-SI open
ESX10-102	single signal, break contact contact SC/SO-SI closed
ESX10-103	group signal change-over contact contact SC-SO open, SC-SI closed
ESX10-115/-125	group signal, make contact contact SC-SO open
Fault	signal output fault conditions: <ul style="list-style-type: none"> ● no operating voltage U_S ● ON/OFF switch S1 is in OFF position ● red LED lighted (electronic disconnection)

Reset input RE

ESX10-124/-125

Electrical data	voltage: max. + DC 32 V high $> \text{DC } 8\text{ V} \leq \text{DC } 32\text{ V}$ low $\leq \text{DC } 3\text{ V} > 0\text{ V}$ power consumption typically 2.6 mA (+DC 24 V) min. pulse duration typically 10 ms
Reset signal RE (= terminal 13,14 or 12 of Module 17plus)	The electronically blocked ESX10-124/-127 may remotely be reset via an external momentary switch due to the falling edge of a +24 V pulse. The reset signal will be fed in terminal 13, 14 or 12 of Module 17plus and is internally pre-wired. The reset simultaneously affects all blocked ESX10-124/-127 channels of the power distribution system, all switched on ESX10-124/-127 channels remain unaffected. With type ESX10-125 the reset only affects the device concerned. By connecting the individual terminals 12 of the Module 17plus a joint reset signal for all ESX10-125 may be generated.
Caution: unused slots have to be fitted with jumpers	

Control input IN+

ESX10-115

Electrical data	see reset input RE
Control signal IN+	+24 V level (HIGH): device will be switched on by a remote ON/OFF signal 0 V level (LOW): device will be switched off by a remote ON/OFF signal
Switch S1 ON/OFF	unit can only be switched on with S1 if a HIGH level is applied to IN+

General data

Fail-safe element:	backup fuse for ESX10 <u>not required</u> because of the integral redundant fail-safe element
Blade terminals	6.3 mm to EN 60934-A6.3-0.8
Housing	moulded
Mounting	plug-in mounting utilising power distribution system Module 17plus or Module 18plus (optionally SVSxx)

4

Technical data (T_{ambient} = 25°C, operating voltage U_G = DC 24 V)

Ambient temperature	0...+50 °C (without condensation, see EN 60204-1)
Storage temperature	-40...+70 °C
Humidity	96 hrs/95 % RH/40 °C to IEC 60068-2-78, test Cab. climate class 3K3 to EN 60721
Vibration	3 g, test to IEC 60068-2-6 test Fc
Degree of protection	IEC 60529, DIN VDE 0470 operating area IP30, terminal area IP00
EMC (EMC directive, CE logo)	emission: EN 61000-6-3 susceptibility: EN 61000-6-2

Technical data (T_{ambient} = 25°C, operating voltage U_G = DC 24 V)

Insulation co-ordination (IEC 60934)	0.5 kV/2 pollution degree 2 re-reinforced insulation in operating area
Dielectric strength	max. DC 32 V (load circuit)
Insulation resistance (OFF condition)	n/a, only electronic disconnection
Approvals	to directive 2014/30/EU, 2011/65/EU ESX10-1...-E additionally directive 2014/34/EU (ATEX)
Dimensions (W x H x D)	12.5 x 70 x 60 mm (tolerances to DIN ISO 286 part 1 IT13)
Mass	approx. 40 g

Preferred types

Preferred types	Preferred ratings (A)							
ESX10	1	2	3	4	6	8	10	12
ESX10-103-DC24V	x	x	x	x	x	x	x	x

Ordering information

Type No.

ESX10 Electronic Circuit Protector for DC 24 V applications

Version

1 standard, without physical isolation in the event of a failure

Signal input

0 without signal input

1 with control input IN+, only ESX10-115

2 with reset input RE, only ESX10-124

Signal outputs

0 without, only ESX10-100

3 signal output F (group signal, change-over) only ESX10-103

4 status output SF (+24 V = OK), only ESX10-104, ESX10-124

5 signal output F (group signal, N/O) only ESX10-115 and ESX10-125)

Operating voltage

DC 24 V rated voltage DC 24 V

Current rating

0.5 A

1 A

2 A

3 A

4 A

6 A

8 A

10 A

12 A

Approvals (optional)

E ATEX / IECEx

ESX10 - 1 0 3 - DC 24 V - 6 A ordering example

ESX10 - 1 0 3 - DC 24 V - 2 A - E ordering example (ATEX)

Custom designed versions

Looking for a version you cannot find in our ordering number code? Please get in touch. We will be pleased to find a solution for you.

Application note

- The user has to ensure that the cable cross section of the load circuit in question complies with the current rating of the ESX10 used.
- In addition special precautions must be taken in the system or machine (e.g. use of a safety PLC) which reliably prevent an automatic re-start of parts of the system (cf. Machinery Directive 2006/42/EG and EN 60204-1, Safety of Machinery). In the event of a failure (short circuit/overload) the load circuit will be disconnected electronically with physical isolation of the contacts by the ESX10.

Approvals

Authority	Standard	File certificate no.	Voltage ratings	Current ratings
UL	UL 2367	E306740	DC 24 V	0.5...12 A
UL	UL 121201 (Class I, Division 2, Groups A, B, C, D)	E320024	DC 24 V	0.5...12 A
UL	UL 508 CSA C22.2 No. 14	E322549	DC 24 V	0.5...12 A
CSA	C22.2 No. 213 (Class I, Division 2 Groups A, B, C, D)	016186	DC 24 V	0.5...12 A
DNV GL	CG-0339 (classes: temperature: B; humidity, vibration, EMC: A)	TAE000025Y	DC 24 V	0.5...12 A
Bureau Veritas	ATEX (EU additionally directive 2014/34/EU) EN 60079-0 EN 60079-7 EN 60079-15	EPS 18 ATEX 1 127 X	DC 24 V	0.5...12 A
IECEX	IEC 60079-0 IEC 60079-7 IEC 60079-15	IECEX EPS 18.0059X	DC 24 V	0.5...12 A

Information on UL approvals/CSA approvals



ESX10
UL2367
Solid State Overcurrent Protectors
UL File # E306740

UL 121201 (Hazardous Locations Class I, Division 2, Group A, B, C, D)
UL File # E320024



ESX10
UL 508, CSA C22.2 No. 14
Auxiliary Devices –Industrial Control Equipment
UL File # E322549



ESX10
CSA C22.2 No: 14
CSA C22.2 No. 213 (Hazardous Locations Class I, Division 2, Group A, B, C, D) - File # 16186

Operating Temperature Code T4 A / 0 °C to 50 °C

- This equipment is suitable for use in Class I, Division 2, Groups A, B, C and D or non-hazardous locations only

WARNING – EXPLOSION HAZARD:

- Do not disconnect equipment unless power has been removed or the area is known to be non-hazardous
- When plugged into the E-T-A 18plus power distribution system the max. current rating for the 18plus EM module is 48 A.

This device is OPEN type equipment that must be used within a suitable end-use system enclosure, the interior of which is accessible only through the use of a tool. The suitability of the enclosure is subject to investigation by the local Authority Having Jurisdiction at the time of installation.

Wiring to or from this device, which enters or leaves the system enclosure, must utilize wiring methods suitable for Class , Division 2 Hazardous Locations, as appropriate for the installation.

Dimensions

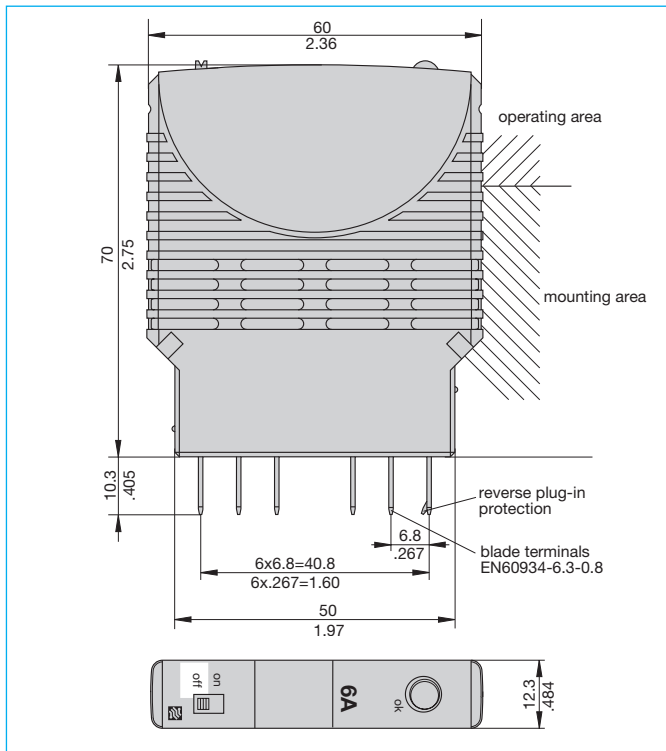

This is a metric design and millimeter dimensions take precedence ($\frac{\text{mm}}{\text{inch}}$)

Table 1: voltage drop, current limitation, max. load current

current rating I_N	typical voltage drop U_{ON} at I_N	active current limitation (typically)	max. load current at 100 % ON duty	
			$T_U = 40\text{ °C}$	$T_U = 50\text{ °C}$
0.5 A	70 mV	$1.8 \times I_N$	0.5 A	0.5 A
1 A	80 mV	$1.8 \times I_N$	1 A	1 A
2 A	130 mV	$1.8 \times I_N$	2 A	2 A
3 A	80 mV	$1.8 \times I_N$	3 A	3 A
4 A	100 mV	$1.8 \times I_N$	4 A	4 A
6 A	130 mV	$1.8 \times I_N$	6 A	5 A
8 A	120 mV	$1.5 \times I_N$	8 A	7 A
10 A	150 mV	$1.5 \times I_N$	10 A	9 A
12 A	180 mV	$1.3 \times I_N$	12 A	10.8 A

Attention: when mounted side-by-side without convection the ESX10-0.. should not carry more than 80 % of its rated load with 100 % ON duty due to thermal effects.

Time/current characteristic curve ($T_A = 25\text{ °C}$)



*1) current limitation typically $1.8 \times I_N$ times rated current at $I_N = 0.5\text{ A}..6\text{ A}$
 current limitation typically $1.5 \times I_N$ times rated current at $I_N = 8\text{ A}$ or 10 A
 current limitation typically $1.3 \times I_N$ times rated current at $I_N = 12\text{ A}$

- The trip time is typically 3 s in the range between 1.1 and $1.8 \times I_N^{*1}$.
- Electronic current limitation occurs at typically $1.8 \times I_N^{*1}$ which means that under all overload conditions (independent of the power supply and the resistance of the load circuit) the max. overload before disconnection will not exceed $1.8 \times I_N^{*1}$ times the current rating. Trip time is between 100 ms (short circuit current I_k) and 3 sec (at overload with high line attenuation).
- Without this current limitation a considerably higher overload current would flow in the event of an overload or short circuit.

Connection and operation elements ESX10-1xx



- 1 LINE+
- 2 11 GND
- 3 13 depending on the version
- 4 14 depending on the version
- 5 12 depending on the version
- 6 2 LOAD
- 7 Status LED
- 8 ON/OFF switch

Terminal wiring diagram ESX10-124



Schematic diagram ESX10-124

ESX10-124-...



Table 2: ESX10 - product version

version	signal input		signal output		
			signal output F		status output SF
ESX10 -...	control input ON/OFF +24 V Control IN+	reset input +24 V RE	group signal N/O	group signal change-over	status OUT +24 V = OK
-100					
-103				x	
-104					x
-115	x		x		
-124		x			x
-125		x	x		

Table 3: Reliable trip of ESX10

Reliable trip of ESX10 with different cable lengths and cross sections							
Resistivity of copper $\rho_0 = 0.0178$ (Ohm x mm ²) / m							
$U_S = \text{DC } 19.2 \text{ V}$ (= 80 % v. 24 V)	voltage drop of ESX10 and tolerance of trip point (typically $1.1 \times I_N = 1.05 \dots 1.35 \times I_N$) have been taken into account.						
ESX10-selected rating I_N (in A) →	3	6					
e. g. trip current $I_{ab} = 1.25 \times I_N$ (in A) →	3.75	7.5	→ ESX10 trips after 3 s				
R_{\max} in Ohm = $(U_S / I_{ab}) - 0.050$ →	5.07	2.51					
The ESX10 reliably trips from 0 Ohm to max. circuitry resistance R_{\max}							
Cable cross section A in mm ² →	0.14	0.25	0.34	0.5	0.75	1	1.5
cable length L in meter (= single length)	cable resistance in Ohm = $(R_0 \times 2 \times L) / A$						
5	1.27	0.71	0.52	0.36	0.24	0.18	0.12
10	2.54	1.42	1.05	0.71	0.47	0.36	0.24
15	3.81	2.14	1.57	1.07	0.71	0.53	0.36
20	5.09	2.85	2.09	1.42	0.95	0.71	0.47
25	6.36	3.56	2.62	1.78	1.19	0.89	0.59
30	7.63	4.27	3.14	2.14	1.42	1.07	0.71
35	8.90	4.98	3.66	2.49	1.66	1.25	0.83
40	10.17	5.70	4.19	2.85	1.90	1.42	0.95
45	11.44	6.41	4.71	3.20	2.14	1.60	1.07
50	12.71	7.12	5.24	3.56	2.37	1.78	1.19
75	19.07	10.68	7.85	5.34	3.56	2.67	1.78
100	25.34	14.24	10.47	7.12	4.75	3.56	2.37
125	31.79	17.80	13.09	8.90	5.93	4.45	2.97
150	38.14	21.36	15.71	10.68	7.12	5.34	3.56
175	44.50	24.92	18.32	12.46	8.31	6.23	4.15
200	50.86	28.48	20.94	14.24	9.49	7.12	4.75
225	57.21	32.04	23.56	16.02	10.68	8.01	5.34
250	63.57	35.60	26.18	17.80	11.87	8.90	5.93
Example 1:	max. length at 1.5 mm ² and 3 A → 214 m						
Example 2:	max. length at 1.5 mm ² and 6 A → 106 m						
Example 3:	mixed wiring: R1 = 40 m in 1.5 mm ² and R2 = 5 m in 0.25 mm ² : (Control cabinet – sensor/actuator level) R1 = 0.95 Ohm, R2 = 0.71 Ohm Total (R1 + R2) = 1.66 Ohm						

4

ESX10 Signal inputs / outputs (wiring diagram)

ESX10 signal inputs / outputs (wiring diagrams)
Signal contacts are shown in the OFF or fault condition.

ESX10-100
without signal input/output

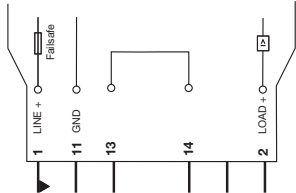

ESX10-103
without signal input
with signal output F (group signal, change-over)

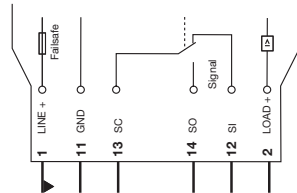

operating condition: SC/SO closed, SC-SI open
fault condition: SC/SO open, SC-SI closed

ESX10-104
without signal input
with status output SF (+24 V = load output ON)

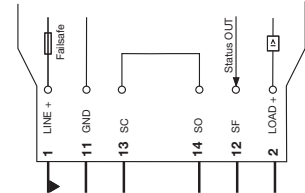

operating condition: SF +24 V = OK
fault condition: SF 0V

ESX10-115-...
with control input IN+ (+DC 24 V)
with signal output F (group signal, N/O)

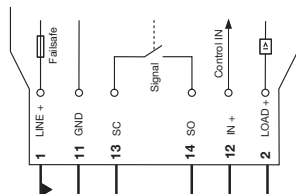

operating condition: SC-SO closed
fault condition: SC-SO open

ESX10-124-...
with reset input RE (+DC 24 V↓)
with status output SF (+24 V = load output ON)

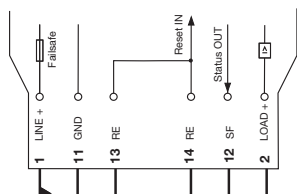

operating condition: SF +24V = OK
fault condition: SF 0V

ESX10-125-...
with reset input RE (+DC 24 V↓)
with signal output F (group signal, N/O)

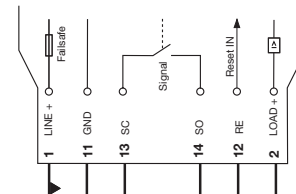

operating condition: SC-SO closed
fault condition: SC-SO open

Installation example Module 17plus

Module 17plus for ESX10-1xx
For technical data please see product group
Power Distribution Modules



Installation example Module 18plus

Module 18plus for ESX10-100 / ESX10-103
For technical data please see product group
Power Distribution Modules



EU Declaration of Conformity for ATEX-version ESX10-TA/-TB-...-E

 **E-T-A Elektrotechnische Apparate GmbH**
ENGINEERING TECHNOLOGY

EU-Konformitätserklärung Nr. 100.218.1053-01
Declaration of Conformity

Wir **E-T-A Elektrotechnische Apparate GmbH**
We Industriestraße 2-8, D-90518 Altdorf, Germany
(Name und Anschrift des Anbieters / supplier's name and address)

erklären in alleiniger Verantwortung, dass das Produkt
declare under our sole responsibility that the product

Elektronische Schutzschalter / Electronic circuit-breaker
Typ/type: **ESX10-1...-E**
ESX10-TA...-E
ESX10-TB...-E
ESX10-TC...-E

(Bezeichnung, Typ/Modell, evtl. Spezifikation/ name, type/model, optionally specification)

auf das sich diese Erklärung bezieht, mit den wesentlichen Anforderungen
folgender Richtlinie(n) übereinstimmt:
to which this declaration relates, is in conformity with the essential requirements of following
Directive(s)

2014/30/EU	EMV-Richtlinie
2014/30/EU	EMC directive
2014/34/EU	ATEX-Richtlinie
2014/34/EU	ATEX directive
2011/65/EU	Beschränkung bestimmter gefährlicher Stoffe (RoHS)
2011/65/EU	Restriction of hazardous substances (RoHS)

Diese Konformitätserklärung folgt den grundlegenden Anforderungen der Norm EN ISO/IEC 17050-1:2010 Konformitätsbewertung - Konformitätserklärung von Anbietern - Teil 1: Allgemeine Anforderungen.

This Declaration of Conformity is following the basic requirements of the standard EN ISO/IEC 17050-1:2010 Conformity assessment - Supplier's declaration of conformity - Part 1: General requirements.

Zur Beurteilung der Übereinstimmung wurde(n) folgende Norm(en) oder normativen Dokumente herangezogen:
For evaluation of the conformity following standard(s) or normative document(s) were consulted:

EN 61000-6-2: 2005 Elektromagnetische Verträglichkeit (EMV)
Teil 6-2: Fachgrundnormen – Störfestigkeit für Industriebereiche
Electromagnetic compatibility (EMC) Part 6-2: Generic standards – Immunity for industrial environments

EN 61000-6-3: 2007 +A1:2011 Elektromagnetische Verträglichkeit (EMV)
Teil 6-3: Fachgrundnormen – Störaussendung für Wohnbereich, Geschäfts- und Gewerbebereiche sowie Kleinbetriebe
Electromagnetic compatibility (EMC) Part 6-3: Generic standards – Emission standard for residential, commercial and light-industrial environments

EN 60079-0:2012+A11:2013 Explosionsgefährdete Bereiche - Teil 0:
Betriebsmittel - Allgemeine Anforderungen/ Explosive atmospheres - Part 0: Equipment - General requirements

EN 60079-7: 2015 Explosionsfähige Atmosphäre - Teil 7: Geräteschutz durch erhöhte Sicherheit "e" / Explosive atmospheres - Part 7: Equipment protection by increased safety "e"

EN 60079-15:2010 Explosionsfähige Atmosphäre - Teil 15: Geräteschutz durch Zündschutzart "n" / Explosive atmospheres - Part 15: Equipment protection by type of protection "n"

E-T-A Elektrotechnische Apparate GmbH • Tel. +49 9187 100 • Fax +49 9187 10398
1/2 form: KE_01.12.2015

 **E-T-A Elektrotechnische Apparate GmbH**
ENGINEERING TECHNOLOGY

EN ISO/IEC 80079-34:2011 Explosionsgefährdete Bereiche - Teil 34:
Anwendung von Qualitätsmanagementsystemen für die Herstellung von Ex-
Produkten / Explosive atmospheres. Application of quality systems for equipment manufacture

EN 50581:2012 Technische Dokumentation zur Beurteilung von Elektro-
und Elektronikgeräten hinsichtlich der Beschränkung gefährlicher Stoffe
Technical documentation for the assessment of electrical and electronic products with respect to
the restriction of hazardous substances

(Titel und/oder Nr. sowie Ausgabedatum der Norm(en) oder der anderen normativen Dokumente / Title and
for number and date of issue of the standard(s) or other normative document(s))
Altdorf, 19. September 2018

(Ort und Datum der Ausstellung /
Place and date of issue)

ppa. Ralf Dietrich (Mitglied der Geschäftsleitung)
(Name, Position und Unterschrift oder gleichwertige
Kennzeichnung des Befugten / name, position and
signature or equivalent of authorized person)

E-T-A Elektrotechnische Apparate GmbH • Tel. +49 9187 100 • Fax +49 9187 10398
2/2 form: KE_01.12.2015

4

This is a metric design and millimeter dimensions take precedence ($\frac{mm}{inch}$)

All dimensions without tolerances are for reference only. In the interest of improved design, performance and cost effectiveness the right to make changes in these specifications without notice is reserved. Product markings may not be exactly as the ordering codes. Errors and omissions excepted.



Компания «ЭлектроПласт» предлагает заключение долгосрочных отношений при поставках импортных электронных компонентов на взаимовыгодных условиях!

Наши преимущества:

- Оперативные поставки широкого спектра электронных компонентов отечественного и импортного производства напрямую от производителей и с крупнейших мировых складов;
- Поставка более 17-ти миллионов наименований электронных компонентов;
- Поставка сложных, дефицитных, либо снятых с производства позиций;
- Оперативные сроки поставки под заказ (от 5 рабочих дней);
- Экспресс доставка в любую точку России;
- Техническая поддержка проекта, помощь в подборе аналогов, поставка прототипов;
- Система менеджмента качества сертифицирована по Международному стандарту ISO 9001;
- Лицензия ФСБ на осуществление работ с использованием сведений, составляющих государственную тайну;
- Поставка специализированных компонентов (Xilinx, Altera, Analog Devices, Intersil, Interpoint, Microsemi, Aeroflex, Peregrine, Syfer, Eurofarad, Texas Instrument, Miteq, Cobham, E2V, MA-COM, Hittite, Mini-Circuits, General Dynamics и др.);

Помимо этого, одним из направлений компании «ЭлектроПласт» является направление «Источники питания». Мы предлагаем Вам помощь Конструкторского отдела:

- Подбор оптимального решения, техническое обоснование при выборе компонента;
- Подбор аналогов;
- Консультации по применению компонента;
- Поставка образцов и прототипов;
- Техническая поддержка проекта;
- Защита от снятия компонента с производства.



Как с нами связаться

Телефон: 8 (812) 309 58 32 (многоканальный)

Факс: 8 (812) 320-02-42

Электронная почта: org@eplast1.ru

Адрес: 198099, г. Санкт-Петербург, ул. Калинина, дом 2, корпус 4, литера А.