

Output rail-to-rail 1 W audio power amplifier with standby mode

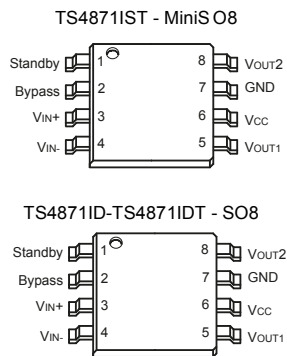

Features

- Operating from $V_{CC} = 2.5\text{ V}$ to 5.5 V
- 1 W rail-to-rail output power @ $V_{CC} = 5\text{ V}$, THD = 1%, $f = 1\text{ kHz}$, with $8\ \Omega$ load
- Ultra low consumption in standby mode (10 nA)
- 75 dB PSRR @ 217 Hz from 5 V to 2.6 V
- Ultra low pop and click
- Ultra low distortion (0.1%)
- Unity gain stable
- Available in SO8 and MiniSO8

Applications

- Mobile phones (cellular / cordless)
- Laptop / notebook computers
- PDAs
- Portable audio devices

Description

The **TS4871** is an audio power amplifier capable of delivering 1 W of continuous RMS output power into $8\ \Omega$ load @ 5 V.

This audio amplifier exhibits 0.1% distortion level (THD) from a 5 V supply for a $P_{out} = 250\text{ mW}$ RMS. An external standby mode control reduces the supply current to less than 10 nA. An internal thermal shutdown protection is also provided.

The **TS4871** has been designed for high quality audio applications such as mobile phones and to minimize the number of external components.

The unity-gain stable amplifier can be configured by external gain setting resistors.

Product status link

[TS4871](#)

1 Pin configuration

Figure 1. Pin connections (top view)

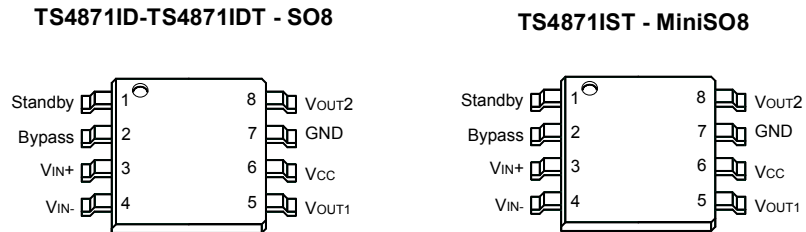

2 Maximum ratings

Table 1. Absolute maximum ratings

Symbol	Parameter	Value	Unit
V_{CC}	Supply voltage ⁽¹⁾	6	V
V_i	Input voltage ⁽²⁾	GND to V_{CC}	V
T_{oper}	Operating free air temperature range	-40 to + 85	°C
T_{stg}	Storage temperature	-65 to +150	°C
T_j	Maximum junction temperature	150	°C
R_{thja}	Thermal resistance junction-to-ambient ⁽³⁾ SO8	175	°C/W
	Thermal resistance junction-to-ambient ⁽³⁾ MiniSO8	215	
P_d	Power dissipation	Internally limited ⁽⁴⁾	
ESD	Human body model	2	kV
ESD	Machine model	200	V
Latch-up	Latch-up immunity	Class A	
	Lead temperature (soldering, 10 s)	260	°C

1. All voltages values are measured with respect to the ground pin.
2. The magnitude of input signal must never exceed $V_{CC} + 0.3\text{ V} / \text{GND} - 0.3\text{ V}$
3. The device is protected in case of overtemperature by a thermal shutdown active @ 150 °C.
4. Exceeding the power derating curves during a long period, involves abnormal operating conditions.

Table 2. Operating conditions

Symbol	Parameter	Value	Unit
V_{CC}	Supply voltage	2.5 to 5.5	V
V_{ICM}	Common mode Input voltage range	GND to $V_{CC} - 1.2\text{ V}$	V
V_{STB}	Standby voltage input: device ON	$\text{GND} \leq V_{STB} \leq 0.5\text{ V}$	V
	Standby voltage input: device OFF	$V_{CC} - 0.5\text{ V} \leq V_{STB} \leq V_{CC}$	
R_L	Load resistor	4 - 32	Ω
R_{thja}	Thermal resistance junction-to-ambient ⁽¹⁾ SO8	150	°C/W
	Thermal resistance junction-to-ambient ⁽¹⁾ MiniSO8	190	

1. This thermal resistance can be reduced with a suitable PCB layout (see power derating curves).

3 Electrical characteristics

Table 3. Electrical characteristics $V_{CC} = +5\text{ V}$, $GND = 0\text{ V}$, $T_{amb} = 25\text{ °C}$ (unless otherwise specified).

Symbol	Parameter	Min.	Typ.	Max.	Unit
I_{CC}	Supply current No input signal, no load		6	8	mA
$I_{STANDBY}^{(1)}$	Standby current No input signal, $V_{STDBY} = V_{CC}$, $R_L = 8\ \Omega$		10	1000	nA
V_{OO}	Output offset voltage No input signal, $R_L = 8\ \Omega$		5	20	mV
P_O	Output power THD = 1% max., $f = 1\text{ kHz}$, $R_L = 8\ \Omega$		1		W
THD + N	Total harmonic distortion + noise $P_O = 250\text{ mW}_{rms}$, $G_v = 2$, $20\text{ Hz} < f < 20\text{ kHz}$, $R_L = 8\ \Omega$		0.15		%
PSRR ⁽²⁾	Power supply rejection ratio $f = 217\text{ Hz}$, $R_L = 8\ \Omega$, $R_{Feed} = 22\text{ K}$, $V_{ripple} = 200\text{ mV}_{rms}$		75		dB
ϕ_M	Phase margin at unity gain $R_L = 8\ \Omega$, $C_L = 500\text{ pF}$		70		Degrees
GM	Gain margin $R_L = 8\ \Omega$, $C_L = 500\text{ pF}$		20		dB
GBP	Gain bandwidth product $R_L = 8\ \Omega$		2		MHz

1. Standby mode is activated when V_{stdby} is tied to V_{CC} .

2. Dynamic measurements - $20 \cdot \log(rms(V_{out})/rms(V_{ripple}))$. V_{ripple} is the surimposed sinus signal to V_{CC} @ $f = 217\text{ Hz}$.

Table 4. Electrical characteristics $V_{CC} = +3.3\text{ V}$, $GND = 0\text{ V}$, $T_{amb} = 25\text{ °C}$ (unless otherwise specified)

Symbol	Parameter	Min.	Typ.	Max.	Unit
I_{CC}	Supply current No input signal, no load		5.5	8	mA
$I_{STANDBY}^{(1)}$	Standby current No input signal, $V_{STDBY} = V_{CC}$, $R_L = 8\ \Omega$		10	1000	nA
V_{OO}	Output offset voltage No input signal, $R_L = 8\ \Omega$		5	20	mV
P_O	Output power THD = 1% max., $f = 1\text{ kHz}$, $R_L = 8\ \Omega$		450		mW
THD + N	Total harmonic distortion + noise $P_O = 250\text{ mW}_{rms}$, $G_v = 2$, $20\text{ Hz} < f < 20\text{ kHz}$, $R_L = 8\ \Omega$		0.15		%
PSRR ⁽²⁾	Power supply rejection ratio $f = 217\text{ Hz}$, $R_L = 8\ \Omega$, $R_{Feed} = 22\text{ k}\Omega$, $V_{ripple} = 200\text{ mV}_{rms}$		75		dB
ϕ_M	Phase margin at unity gain $R_L = 8\ \Omega$, $C_L = 500\text{ pF}$		70		Degrees
GM	Gain margin $R_L = 8\ \Omega$, $C_L = 500\text{ pF}$		20		dB
GBP	Gain bandwidth product $R_L = 8\ \Omega$		2		MHz

1. Standby mode is activated when V_{stbby} is tied to V_{CC}

2. Dynamic measurements - $20 \cdot \log(\text{rms}(V_{out})/\text{rms}(V_{ripple}))$. V_{ripple} is the surimposed sinus signal to V_{CC} @ $f = 217\text{ Hz}$

Note: All electrical values are made by correlation between 2.6 V and 5 V measurements.

Table 5. Electrical characteristics $V_{CC} = +2.6\text{ V}$, $GND = 0\text{ V}$, $T_{amb} = 25\text{ °C}$ (unless otherwise specified).

Symbol	Parameter	Min.	Typ.	Max.	Unit
I_{CC}	Supply current No input signal, no load		5.5	8	mA
$I_{STANDBY}^{(1)}$	Standby current No input signal, $V_{STDBY} = V_{CC}$, $R_L = 8\ \Omega$		10	1000	nA
V_{OO}	Output offset voltage No input signal, $R_L = 8\ \Omega$		5	20	mV
P_O	Output power THD = 1% max., $f = 1\text{ kHz}$, $R_L = 8\ \Omega$		260		mW
THD + N	Total harmonic distortion + noise $P_O = 250\text{ mW}_{rms}$, $G_v = 2$, $20\text{ Hz} < f < 20\text{ kHz}$, $R_L = 8\ \Omega$		0.15		%
PSRR ⁽²⁾	Power supply rejection ratio $f = 217\text{ Hz}$, $R_L = 8\ \Omega$, $R_{Feed} = 22\text{ k}\Omega$, $V_{ripple} = 200\text{ mV}_{rms}$		75		dB

Symbol	Parameter	Min.	Typ.	Max.	Unit
ϕ_M	Phase margin at unity gain $R_L = 8 \Omega$, $C_L = 500 \text{ pF}$		70		Degrees
GM	Gain margin $R_L = 8 \Omega$, $C_L = 500 \text{ pF}$		20		dB
GBP	Gain bandwidth product $R_L = 8 \Omega$		2		MHz

- Standby mode is activated when V_{stdby} is tied to V_{CC}
- Dynamic measurements - $20 \cdot \log(\text{rms}(V_{out})/\text{rms}(V_{ripple}))$. V_{ripple} is the surimposed sinus signal to V_{CC} @ $f = 217 \text{ Hz}$

Table 6. Bill of material

Components	Functional description
R_{in}	Inverting input resistor which sets the closed loop gain in conjunction with R_{feed} . This resistor also forms a high pass filter with C_{in} [$f_c = 1 / (2 \times P_i \times R_{in} \times C_{in})$]
C_{in}	Input coupling capacitor which blocks the DC voltage at the amplifier input terminal
R_{feed}	Feed back resistor which sets the closed loop gain in conjunction with R_{in}
C_s	Supply bypass capacitor which provides power supply filtering
C_b	Bypass pin capacitor which provides half supply filtering
C_{feed}	Low pass filter capacitor allowing to cut the high frequency [low pass filter cut-off frequency $1 / (2 \times P_i \times R_{feed} \times C_{feed})$]
R_{stb}	Pull-up resistor which fixes the right supply level on the standby pin
G_v	Closed loop gain in BTL configuration = $2 \times (R_{feed} / R_{in})$

Remarks

- All measurements, except PSRR measurements, are made with a supply bypass capacitor $C_s = 100 \mu\text{F}$.
- External resistors are not needed for having better stability when supply @ V_{CC} down to 3 V. By the way, the quiescent current remains the same.
- The standby response time is about 1 μs .

4 Electrical characteristics curves

Figure 2. Open loop frequency response Vcc=5 V

Figure 3. Open loop frequency response ZL=8 Ω

Figure 4. Open loop frequency response Vcc=3.3 V

Figure 5. Open loop frequency response Vcc=3.3 V, ZL=8 Ω

Figure 6. Open loop frequency response Vcc=2.6 V

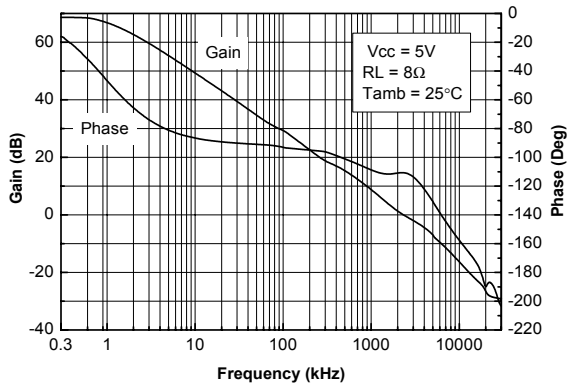
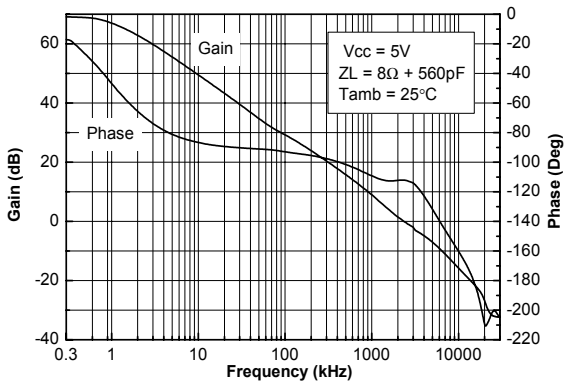
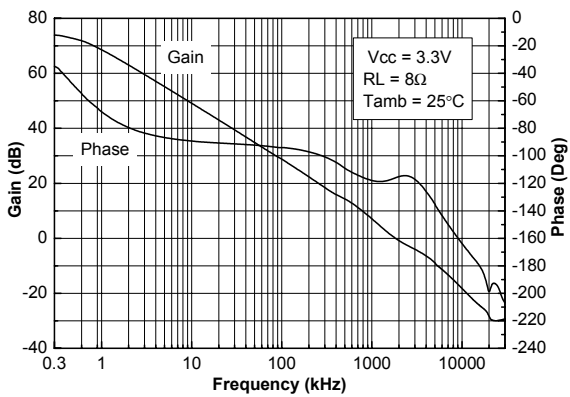
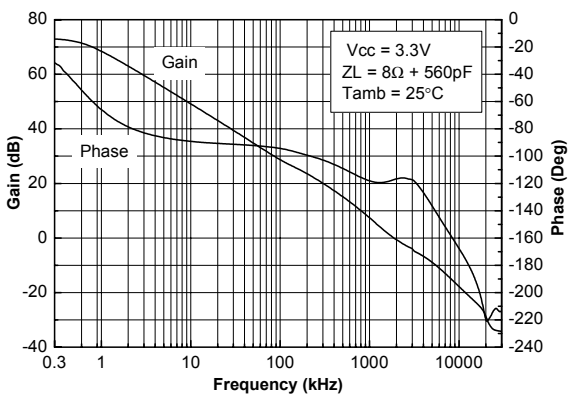
Figure 7. Open loop frequency response Vcc=2.6 V, ZL=8 Ω

Figure 8. Open loop frequency response Vcc=5 V, CL=560 pF

Figure 9. Open loop frequency response Vcc=3.3 V, CL=560 pF

Figure 10. Open loop frequency response Vcc=2.6 V, CL=560 pF

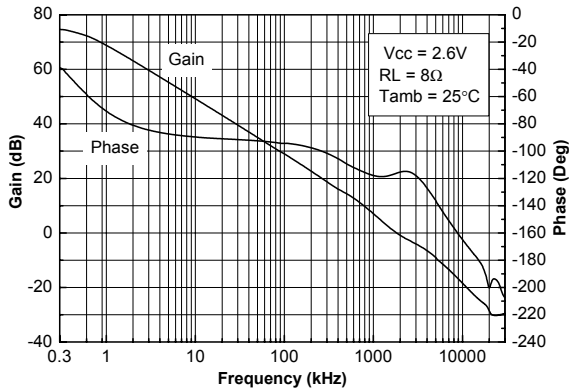
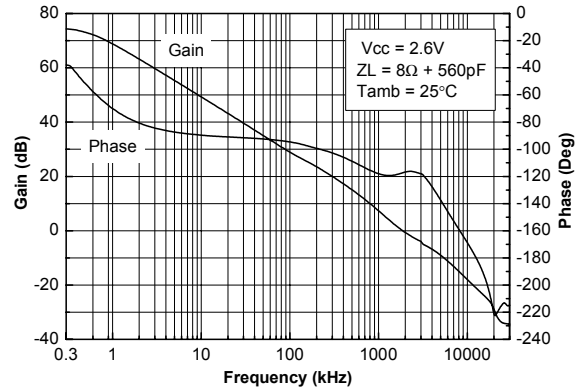
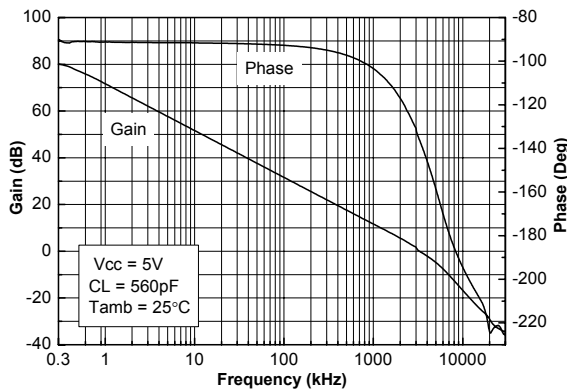
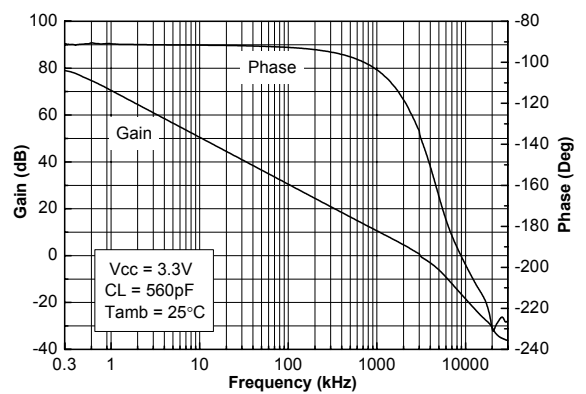
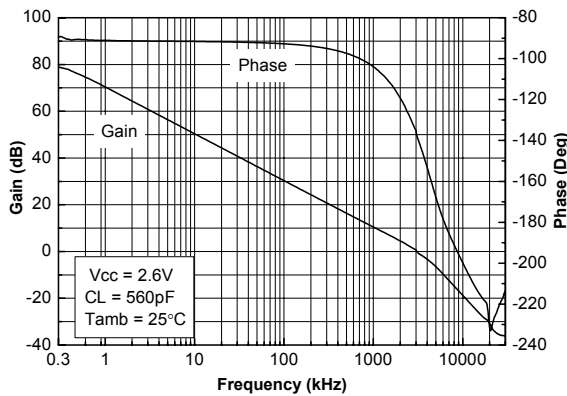
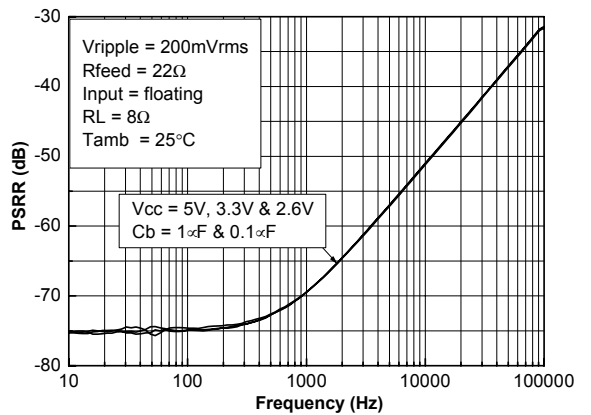
Figure 11. Power supply rejection ratio (PSRR) vs power supply

Figure 12. Power supply rejection ratio (PSRR) vs feedback capacitor

Figure 13. Power supply rejection ratio (PSRR) vs bypass capacitor

Figure 14. Power supply rejection ratio (PSRR) vs input capacitor

Figure 15. Power supply rejection ratio (PSRR) vs feedback resistor

Figure 16. Pout @ THD + N = 1% vs supply voltage vs RL

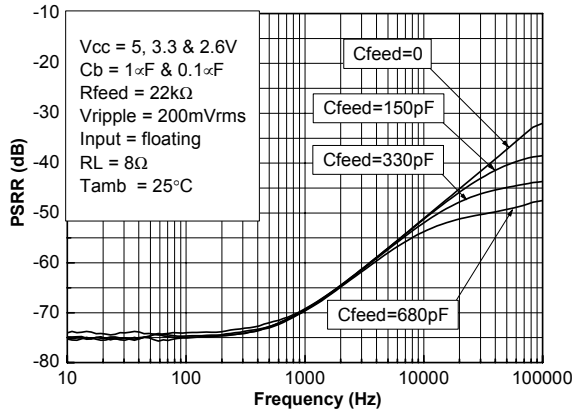
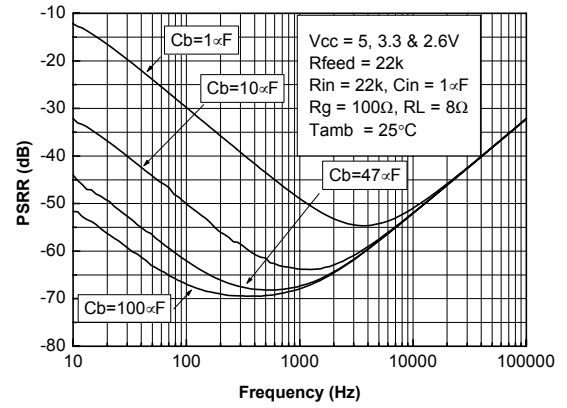
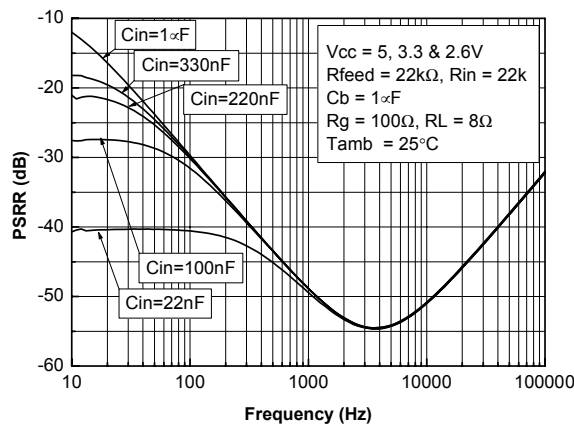
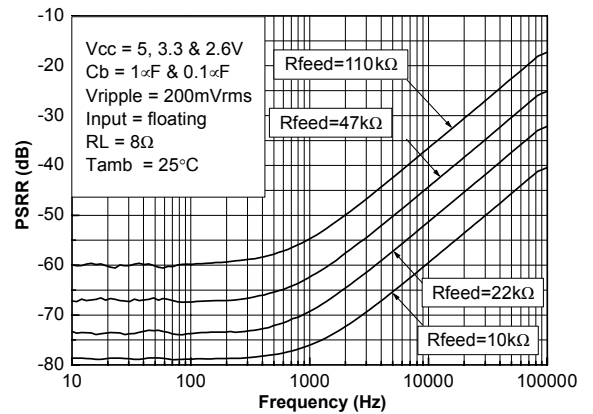
Figure 17. Pout @ THD + N = 10% vs supply voltage vs RL

Figure 18. Power dissipation vs Pout Vcc=5 V

Figure 19. Power dissipation vs Pout Vcc=3.3 V

Figure 20. Power dissipation vs Pout Vcc=2.6 V

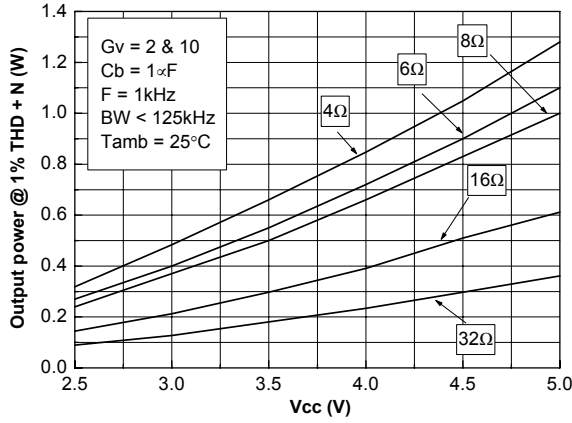
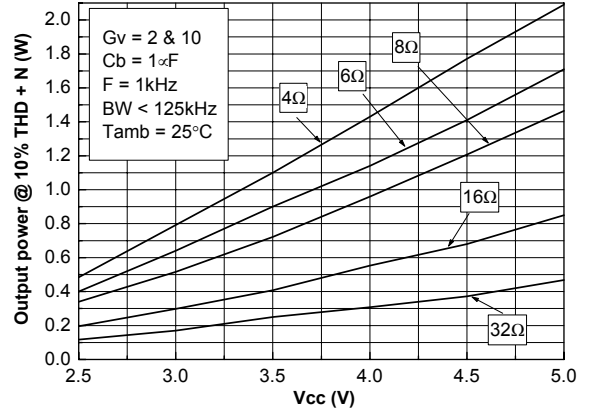
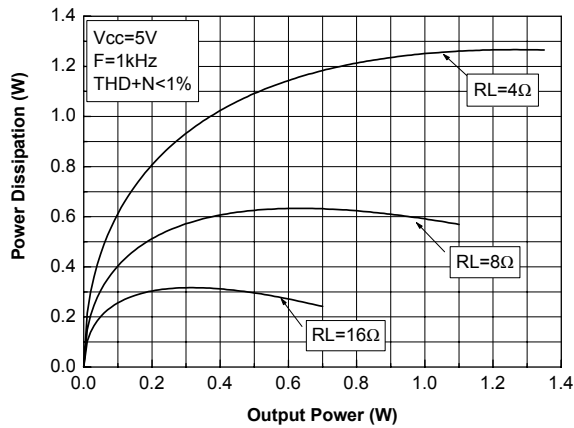
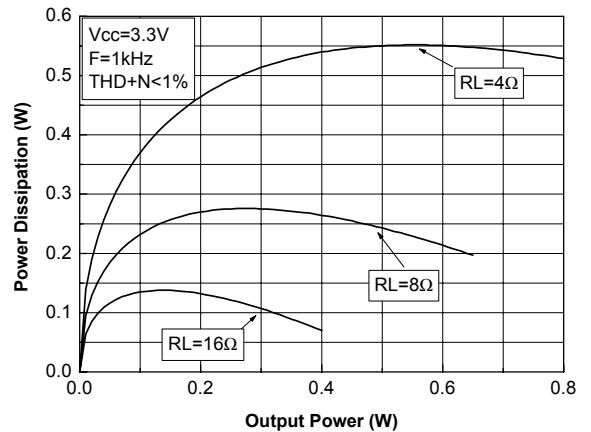
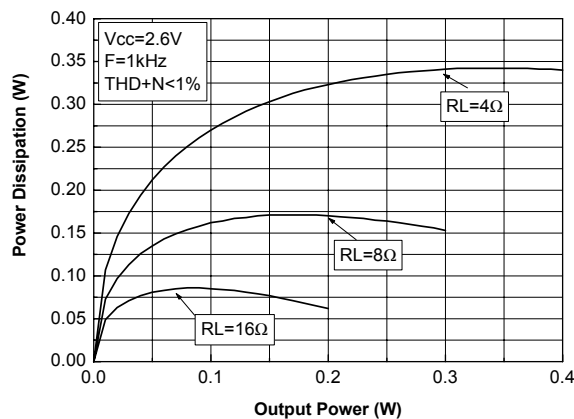
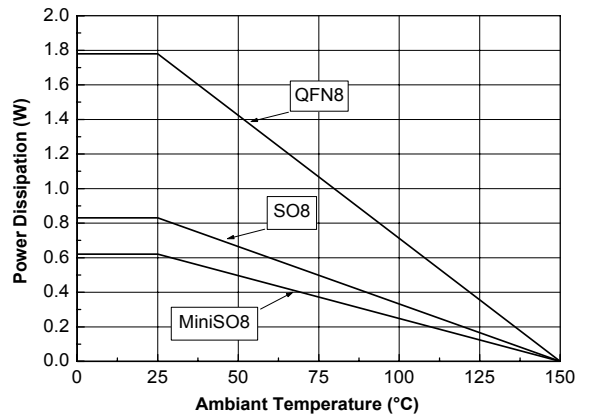
Figure 21. Power derating curves

Figure 22. THD + N vs output power Gv=2, Vcc= 5 V

Figure 23. THD + N vs output power Gv=10, Vcc =5 V

Figure 24. THD + N vs output power Gv=2, Vcc = 3.3 V

Figure 25. THD + N vs output power Gv=10, Vcc = 3.3 V

Figure 26. THD + N vs output power $G_v=2$, $V_{cc} = 2.6\text{ V}$

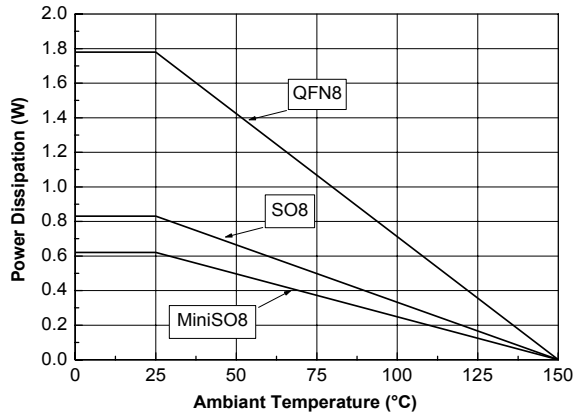
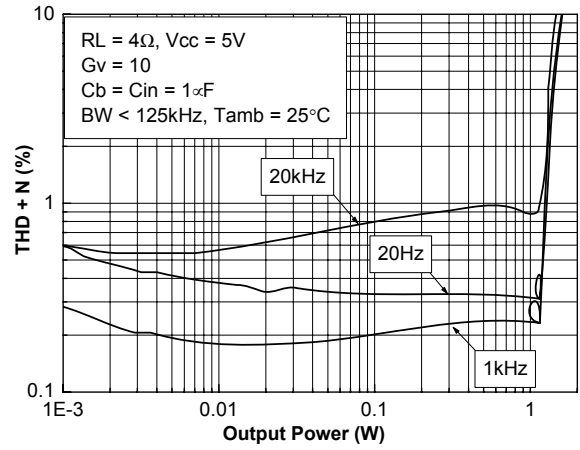
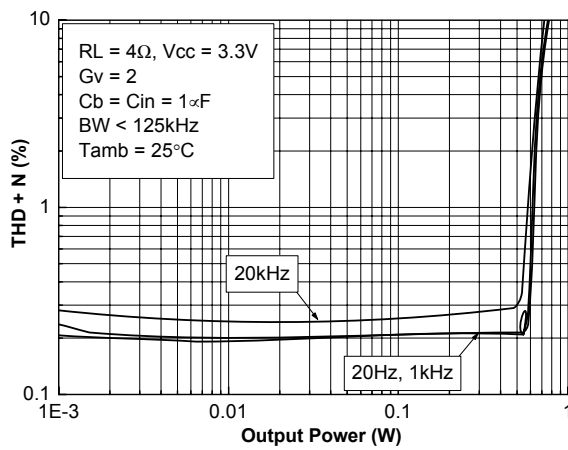
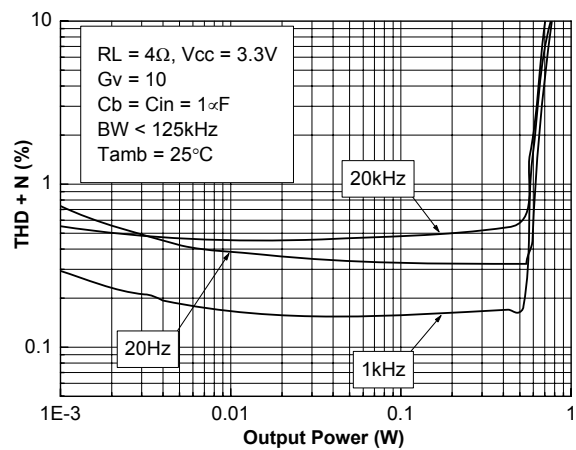
Figure 27. THD + N vs output power $G_v=10$, $V_{cc} = 2.6\text{ V}$

Figure 28. THD + N vs output power $G_v=2$, $V_{cc}= 5\text{ V}$, $RL=8\Omega$

Figure 29. THD + N vs output power $G_v=10$, $V_{cc} = 5\text{ V}$

Figure 30. THD + N vs output power RL= 8 Ω

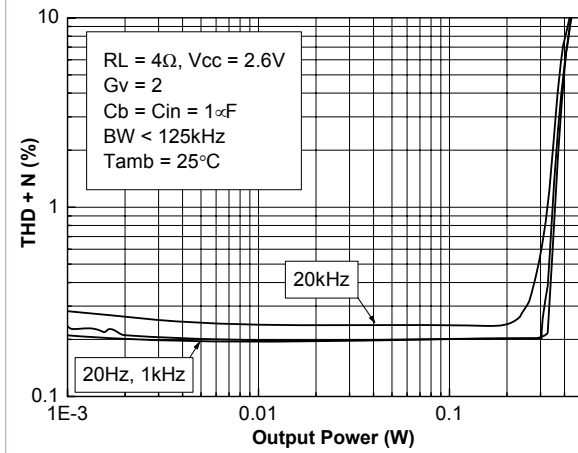
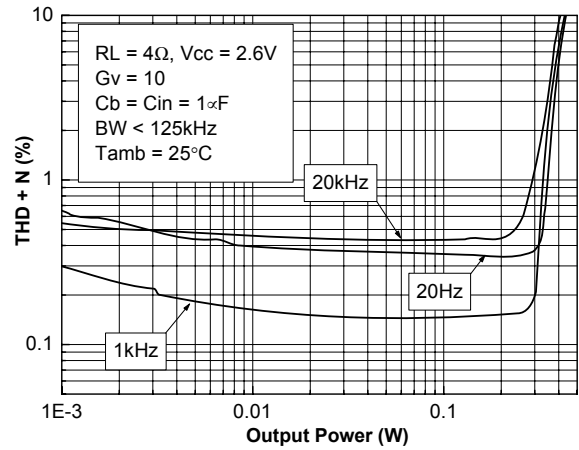
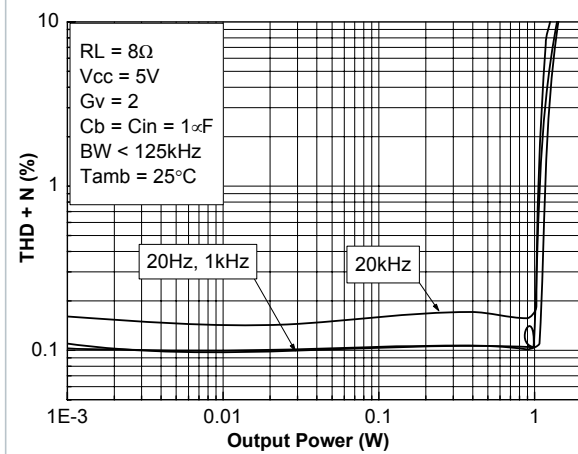
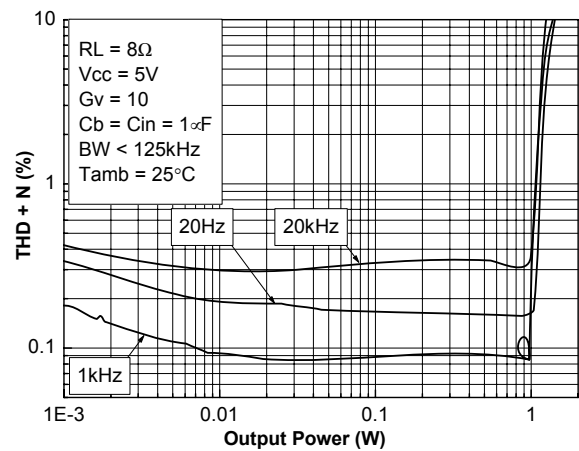
Figure 31. THD + N vs output power RL= 8 Ω , Vcc=3.3 V

Figure 32. THD + N vs output power RL= 8 Ω , Vcc=2.6 V

Figure 33. THD + N vs output power RL= 8 Ω , Gv=10

Figure 34. THD + N vs output power Gv=2, Vcc=5 V, Cb=0.1 μ F

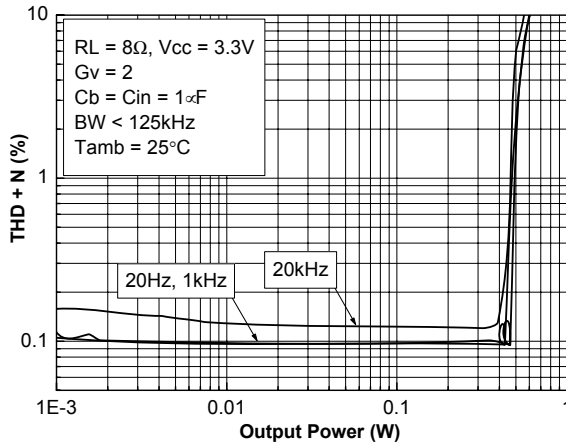
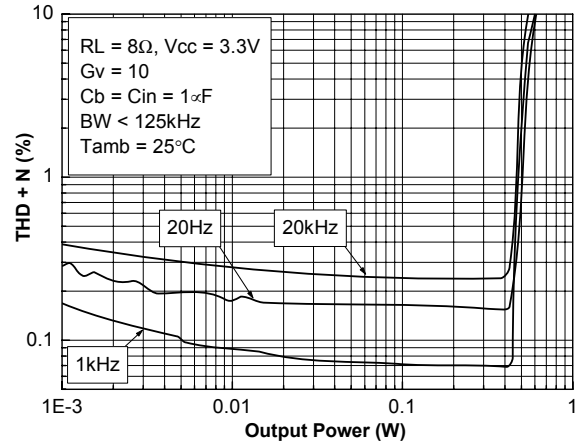
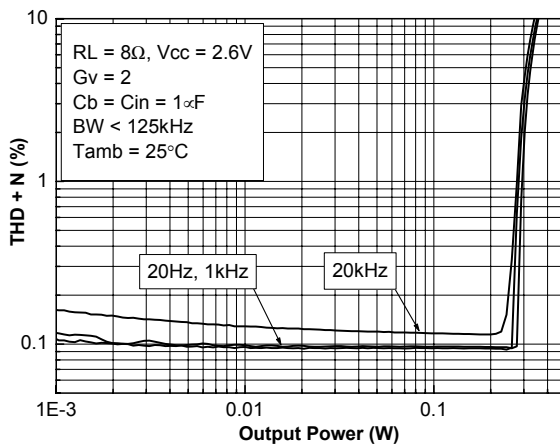
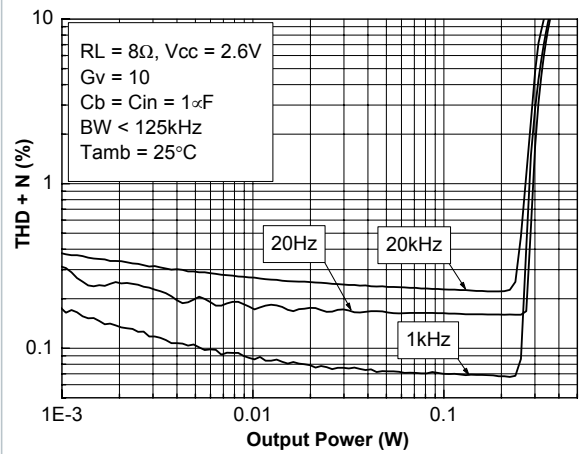
Figure 35. THD + N vs output power Gv=10, Vcc = 5 V, Cb=0.1 μ F

Figure 36. THD + N vs output power Gv=2, Vcc = 3.3 V, Cb=0.1 μ F

Figure 37. THD + N vs output power Gv=10, Vcc=3.3 V, Cb=0.1 μ F

Figure 38. THD + N vs output power $G_v=2$, $V_{cc} = 2.6\text{ V}$, $C_b=0.1\ \mu\text{F}$

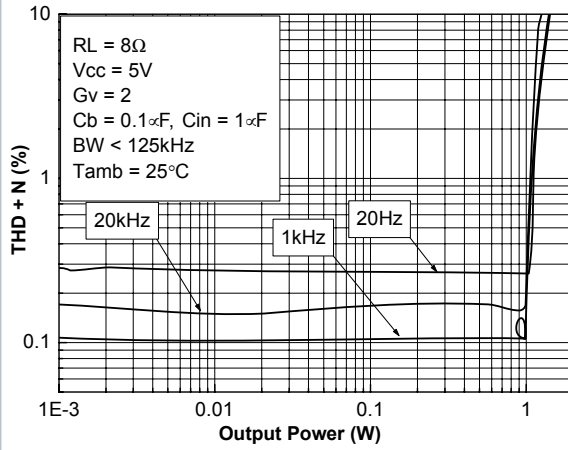
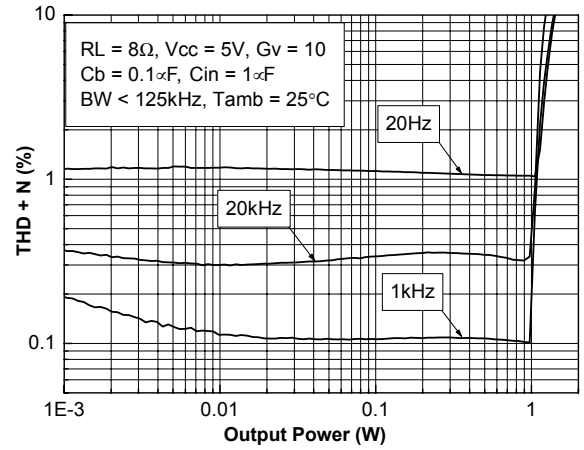
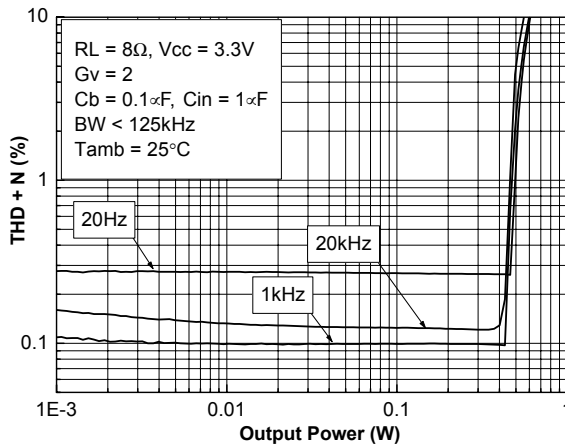
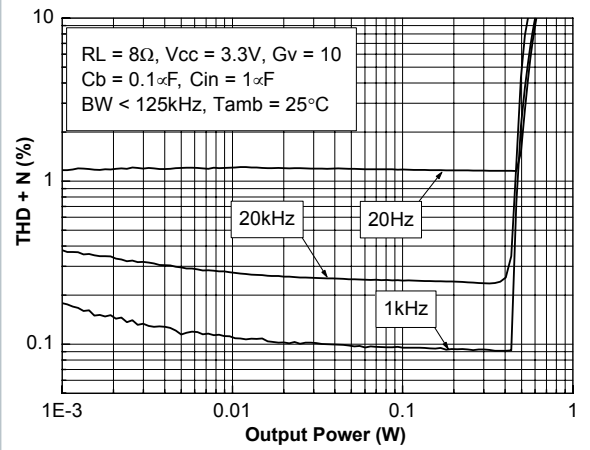
Figure 39. THD + N vs output power $G_v=10$, $V_{cc}=2.6\text{ V}$, $C_b=0.1\ \mu\text{F}$

Figure 40. THD + N vs output power $RL=16\ \Omega$ $V_{cc}=0.5\text{ V}$

Figure 41. THD + N vs output power $RL=16\ \Omega$ $G_v=10$

Figure 42. THD + N vs output power $R_L=16\ \Omega$, $G_v=2$

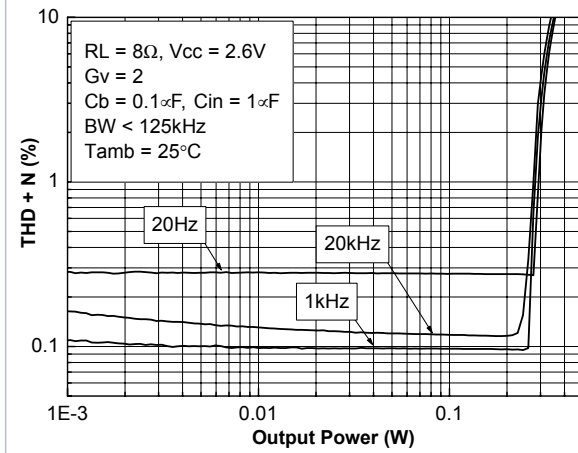
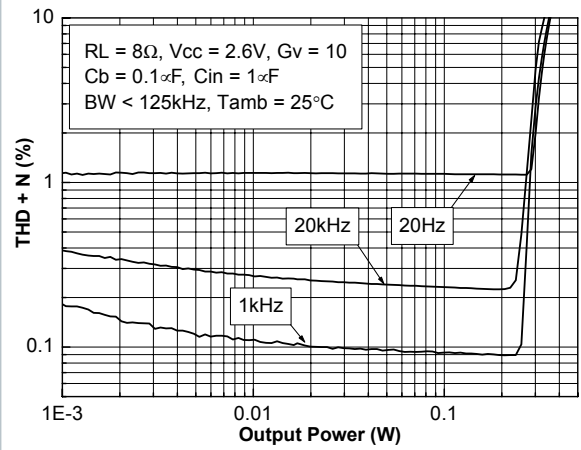
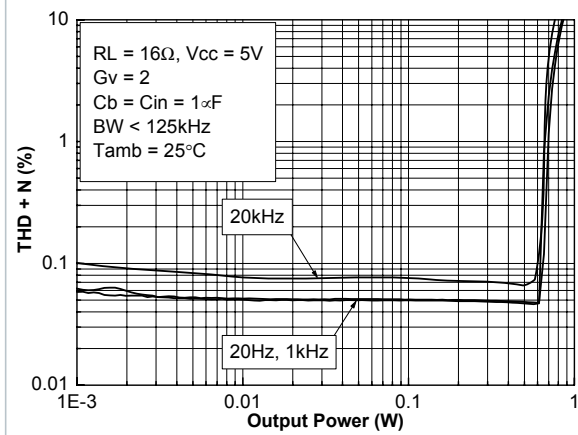
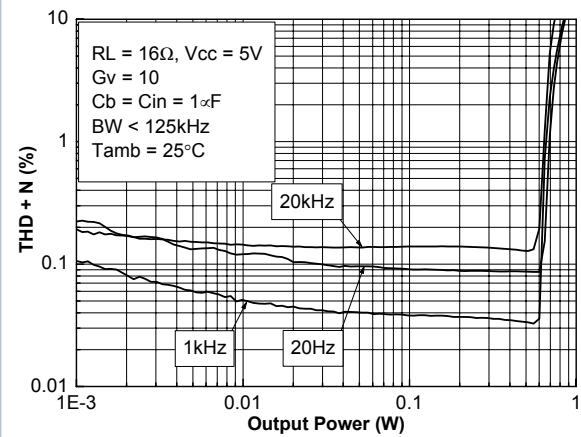
Figure 43. THD + N vs output power $R_L=16\ \Omega$, $G_v=10$, $V_{CC}=3.3\ \text{V}$

Figure 44. THD + N vs output power $R_L=16\ \Omega$, $V_{CC}=2.6\ \text{V}$

Figure 45. THD + N vs output power $R_L=16\ \Omega$, $V_{CC}=2.6\ \text{V}$, $G_v=10$

Figure 46. THD + N vs frequency

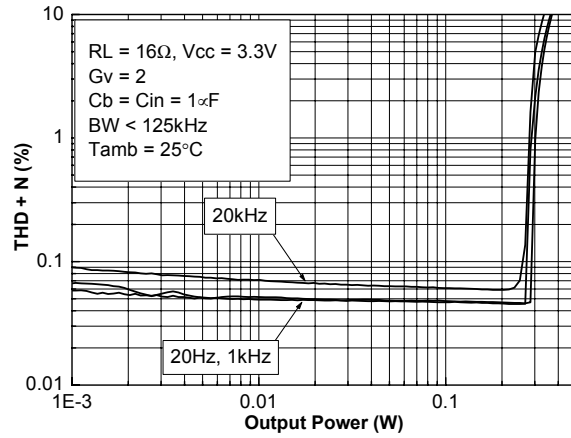
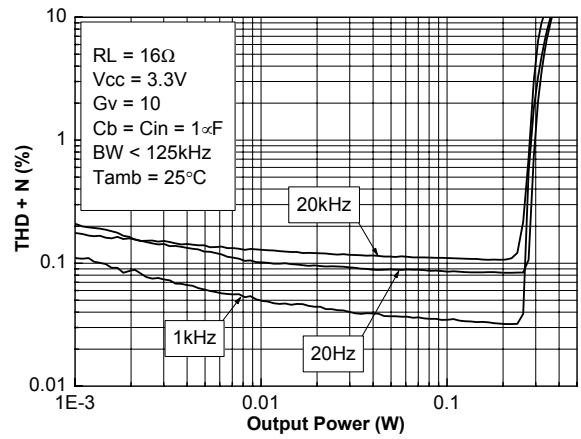
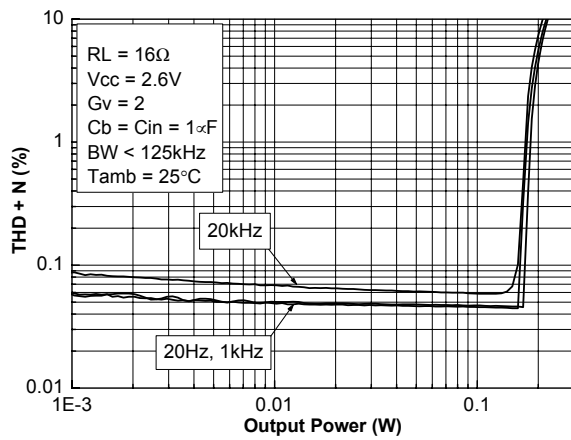
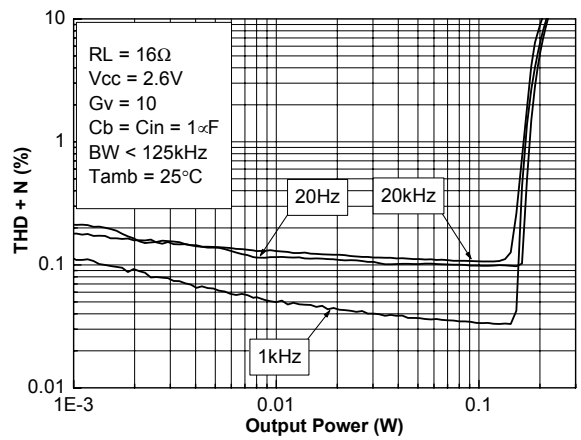
Figure 47. THD + N vs frequency, $V_{CC}=5V$

Figure 48. THD + N vs frequency, $V_{CC}=3.3V$

Figure 49. THD + N vs frequency, $G_v=10$

Figure 50. THD + N vs frequency, Vcc=2.6 V

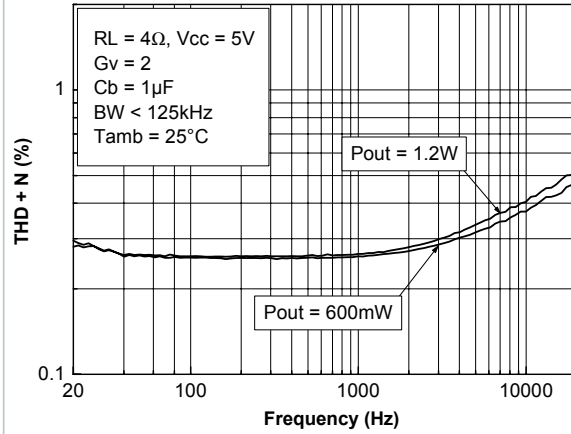
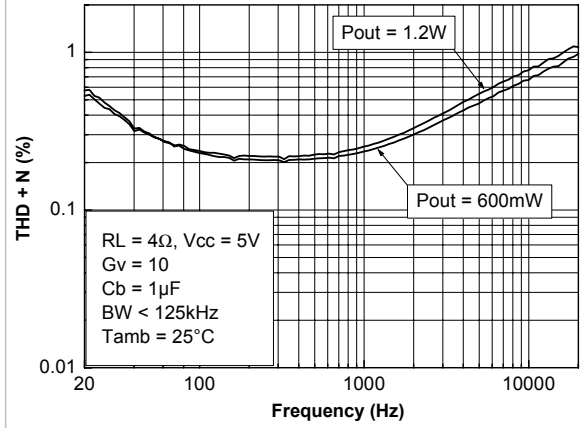
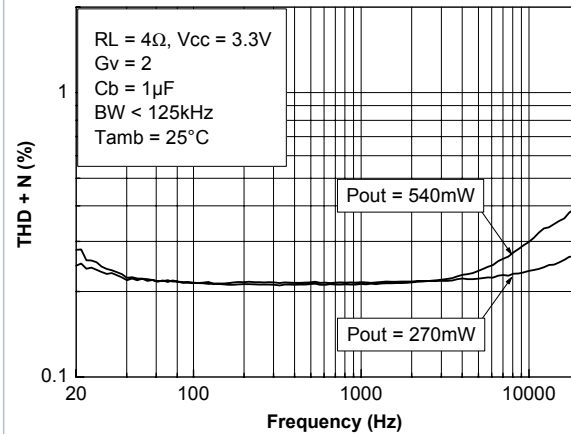
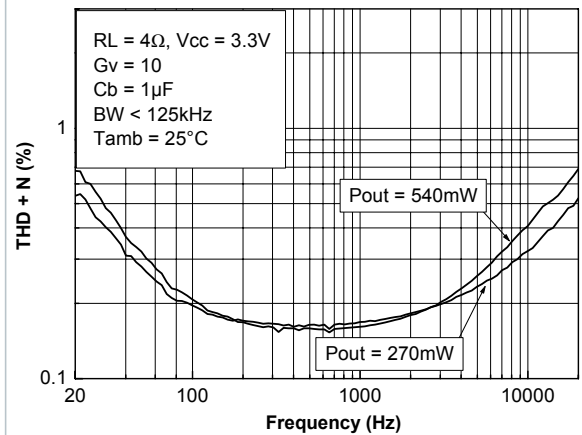
Figure 51. THD + N vs frequency, Vcc=2.6 V, RL = 4 Ω

Figure 52. THD + N vs frequency, Vcc=5 V, RL=8 Ω

Figure 53. THD + N vs frequency, Pout=450 mW

Figure 54. THD + N vs frequency, Pout=900 mW

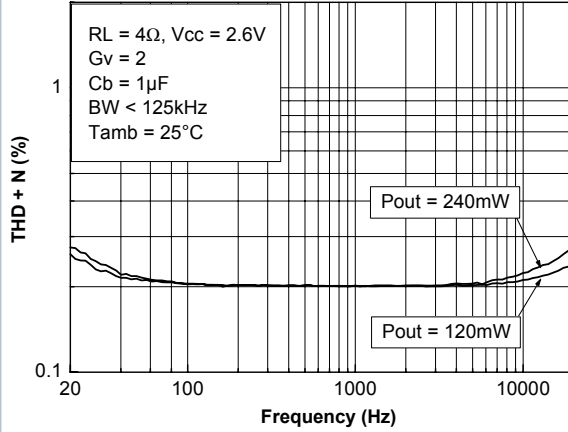
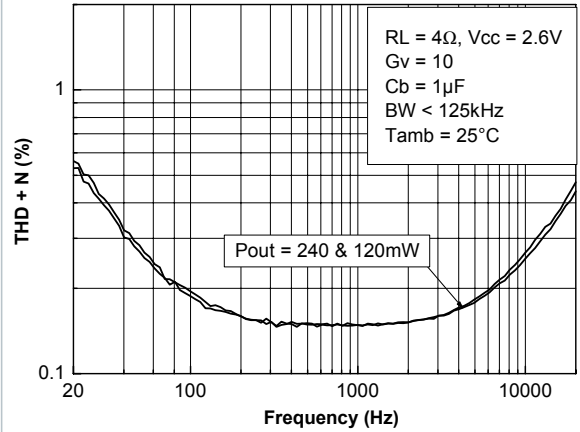
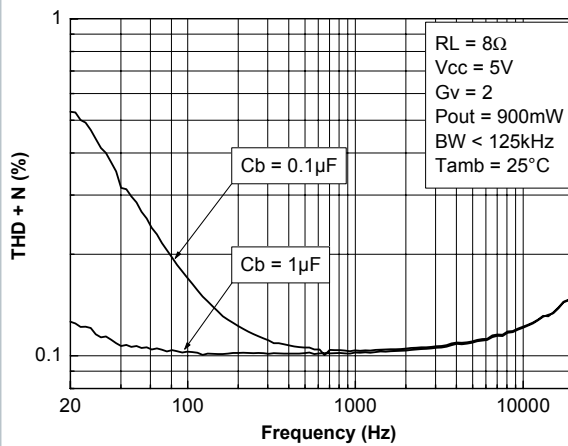
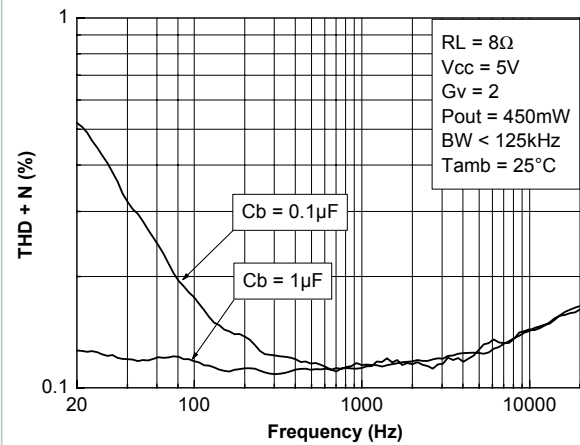
Figure 55. THD + N vs frequency, Pout=450 mW, RL=8 Ω

Figure 56. THD + N vs frequency, Pout=400 mW

Figure 57. THD + N vs frequency, Pout=200 mW

Figure 58. THD + N vs frequency, Pout=400 mW, Gv=010

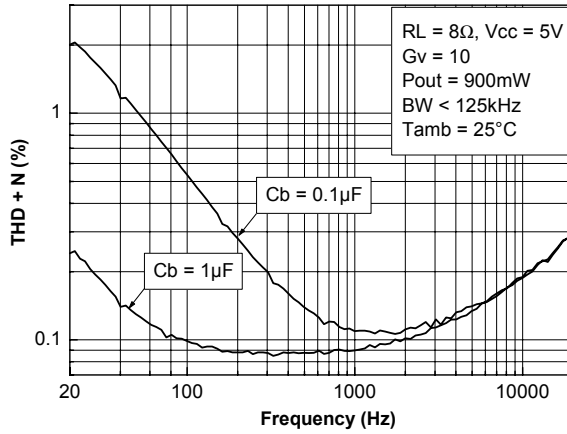
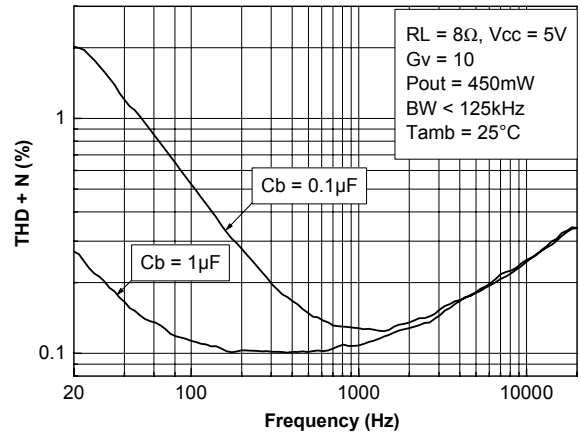
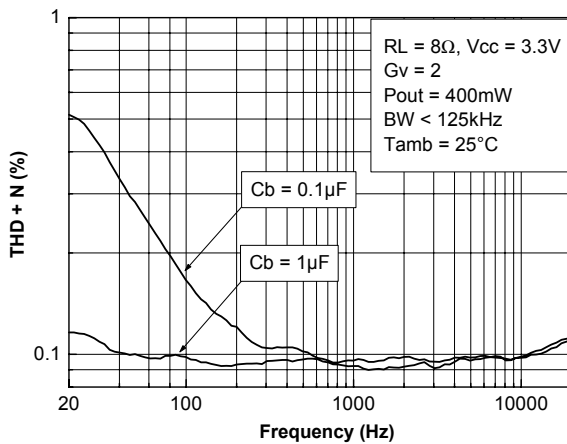
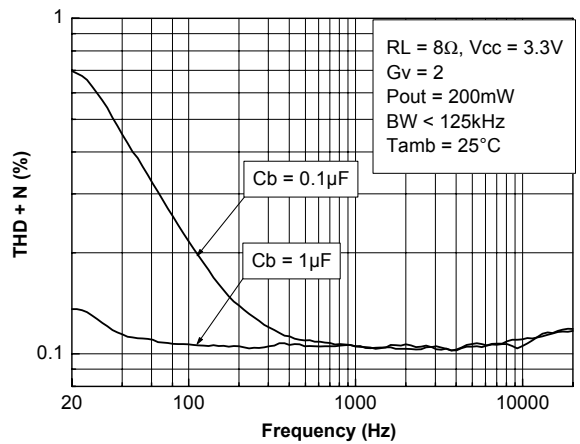
Figure 59. THD + N vs frequency, Pout=200 mW

Figure 60. THD + N vs frequency, Pout=220 mW

Figure 61. THD + N vs frequency, Pout=110 mW

Figure 62. THD + N vs frequency, Pout=220 mW, Vcc= 2.6 V

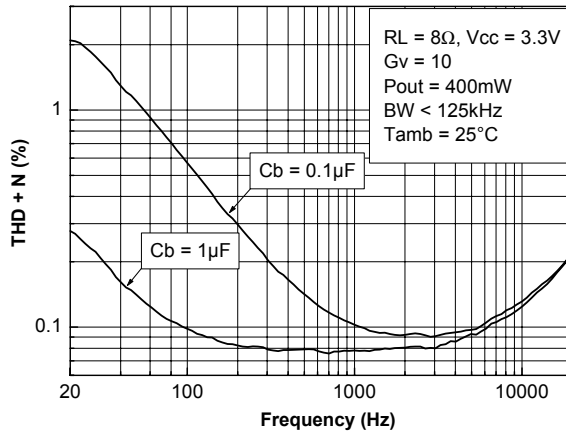
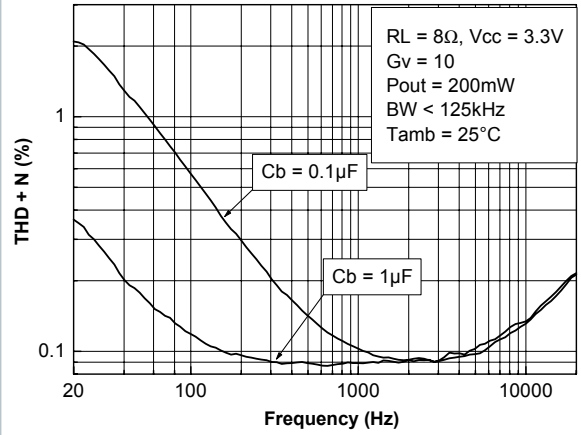
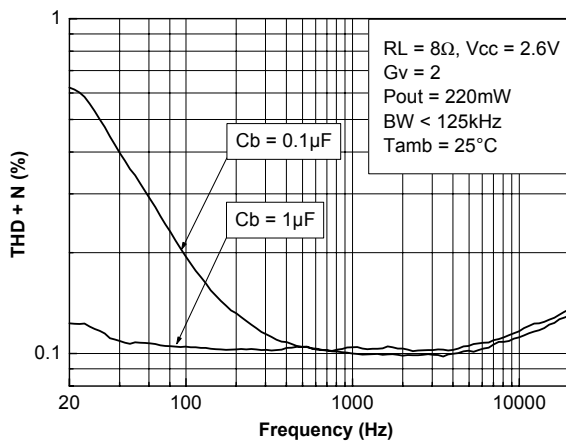
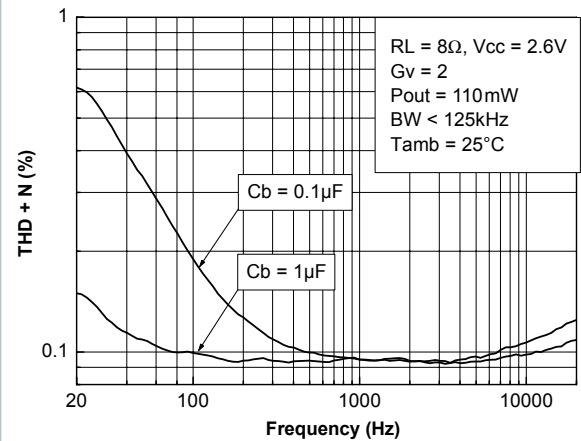
Figure 63. THD + N vs frequency, Pout=110 mW, Vcc= 2.6 V

Figure 64. THD + N vs frequency, RL=16 Ω

Figure 65. THD + N vs frequency, RL=16 Ω , Gv=10

Figure 66. THD + N vs frequency, $RL=16\ \Omega$, $Gv=2$

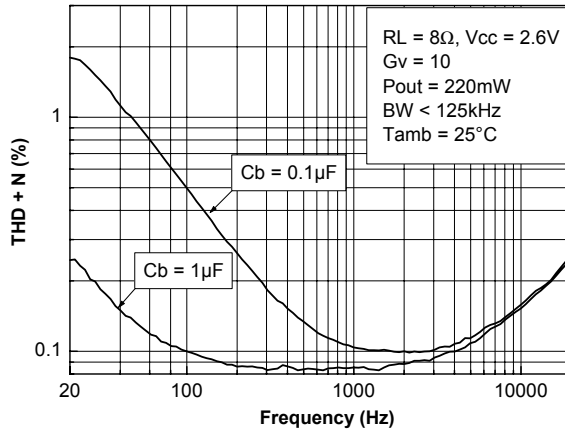
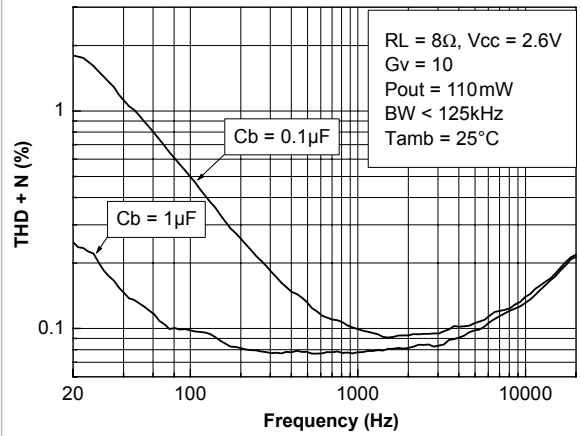
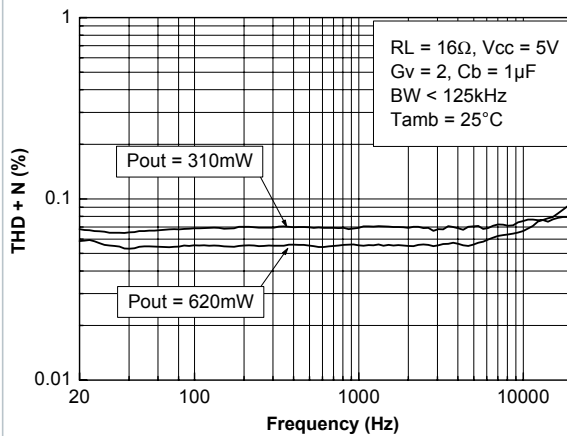
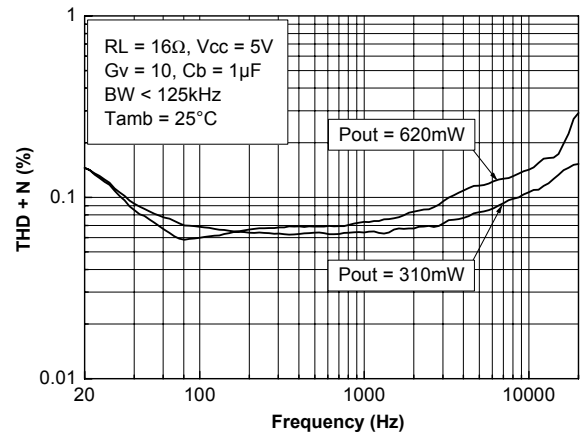
Figure 67. THD + N vs frequency, $RL=16\ \Omega$, $Gv=10$, $Vcc=3.3\ V$

Figure 68. THD + N vs frequency, $RL=16\ \Omega$, $Gv=2$, $Vcc=2.6\ V$

Figure 69. THD + N vs frequency, $RL=16\ \Omega$, $Gv=10$, $Pout=160\ mW$

Figure 70. Signal-to-noise ratio vs power supply with unweighted filter (20 Hz to 20 kHz)

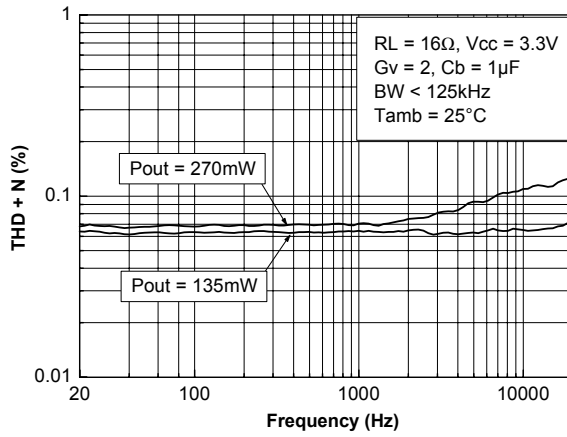
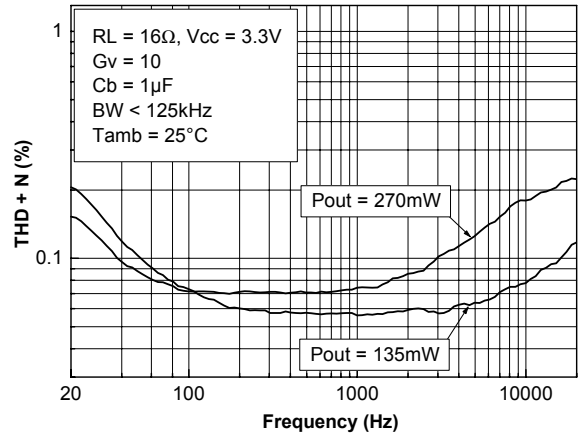
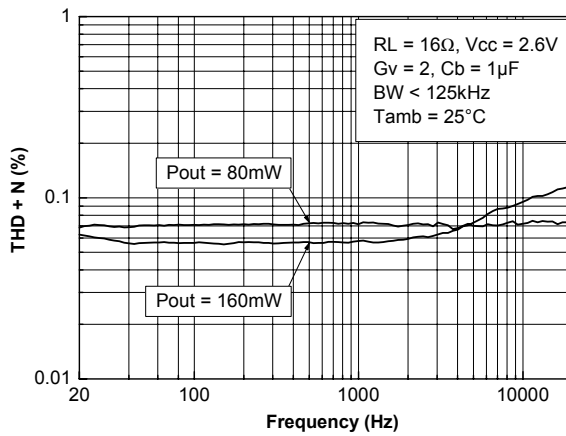
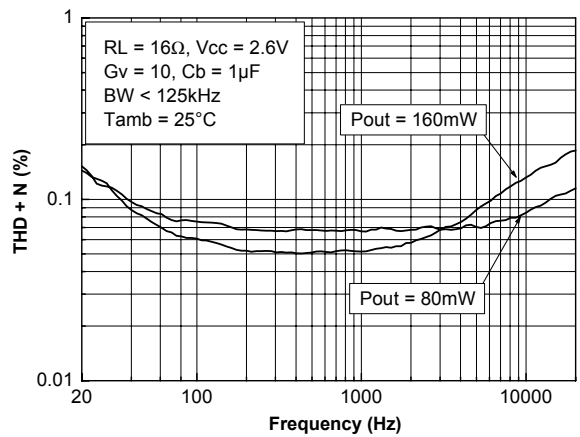
Figure 71. Signal-to-noise ratio vs power supply with weighted filter type A

Figure 72. Signal-to-noise ratio vs power supply with weighted filter type A Gv=2

Figure 73. Current consumption vs power supply voltage

Figure 74. Signal-to-noise ratio vs power supply with unweighted filter (20 Hz to 20 kHz) $G_v=10$

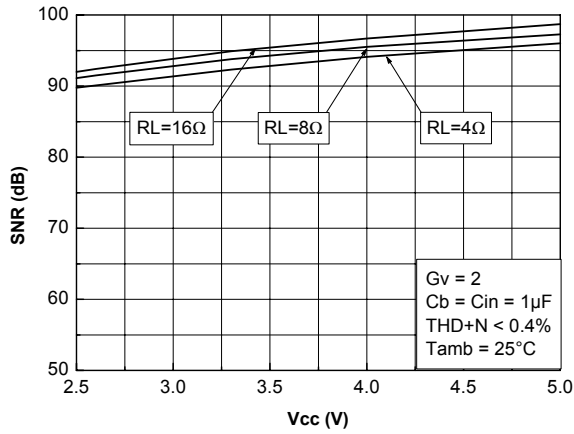
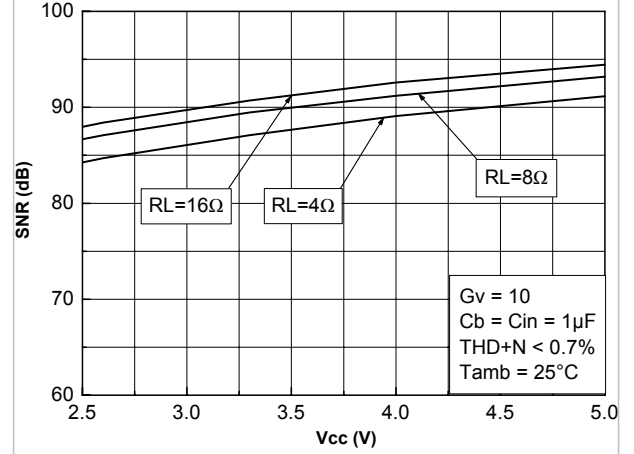
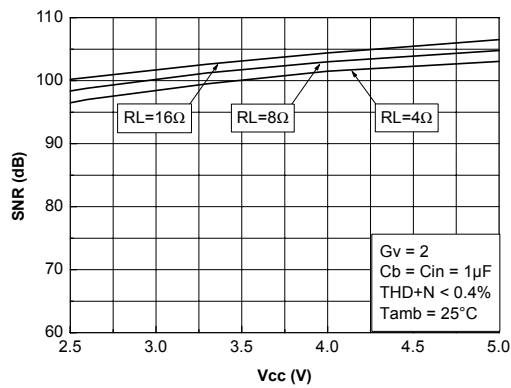
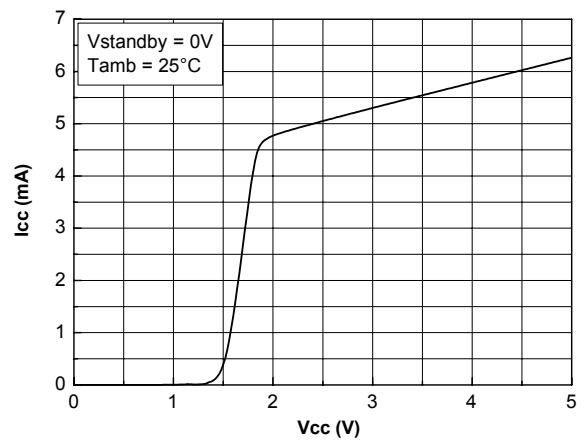
Figure 75. Current consumption vs standby voltage @ $V_{cc} = 5 V$

Figure 76. Current consumption vs standby voltage @ $V_{cc} = 2.6 V$

Figure 77. Current consumption vs standby voltage @ $V_{cc} = 3.3 V$

Figure 78. Clipping voltage vs power supply voltage and load resistor

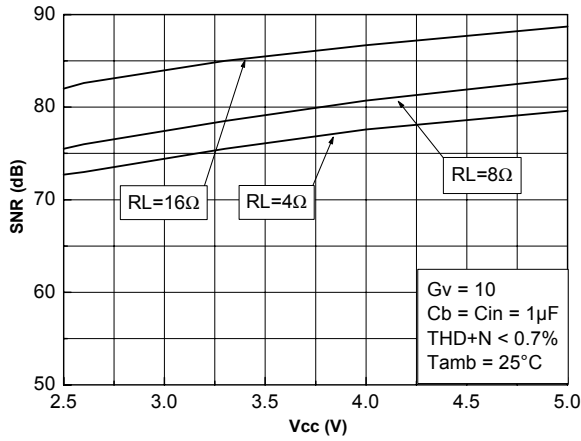
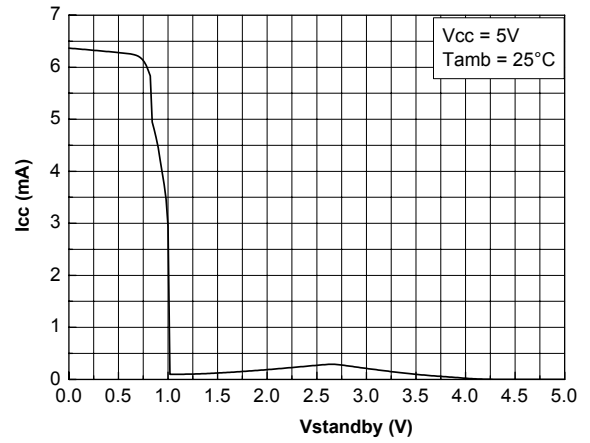
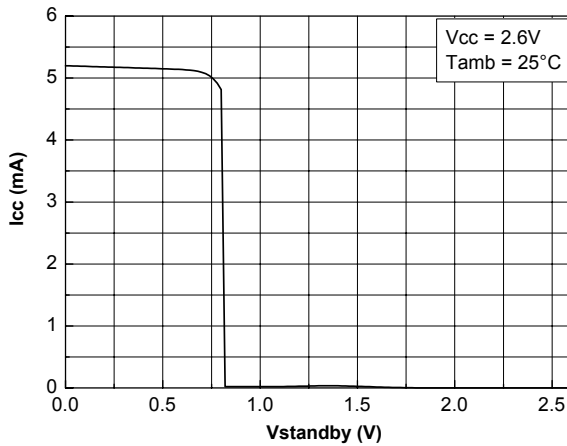
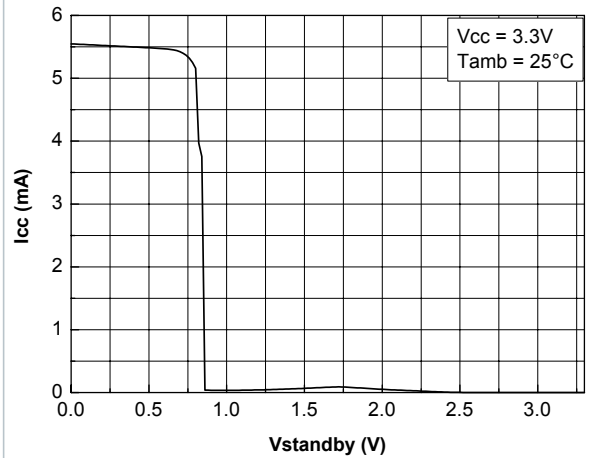
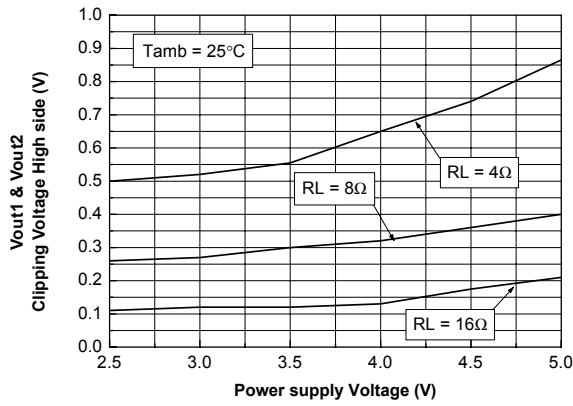
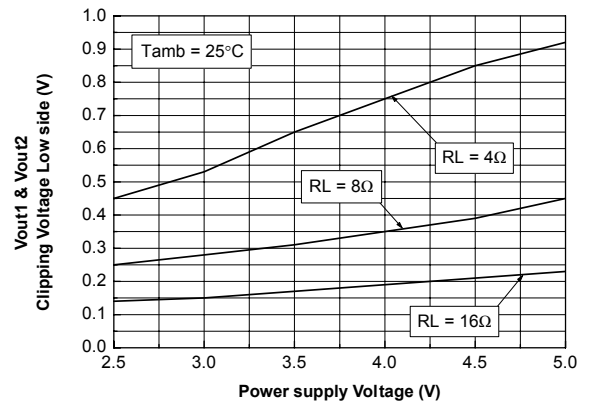
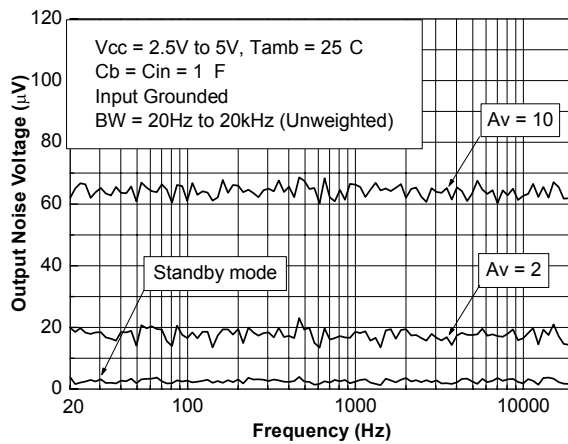
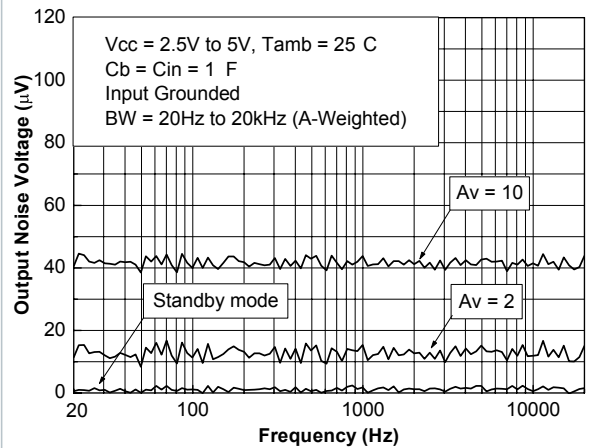
Figure 79. Clipping voltage low-side vs power supply voltage and load resistor

Figure 80. Vout1+Vout2 unweighted noise floor

Figure 81. Vout1+Vout2 A-weighted noise floor

5 Application information

Figure 82. Demoboard schematic

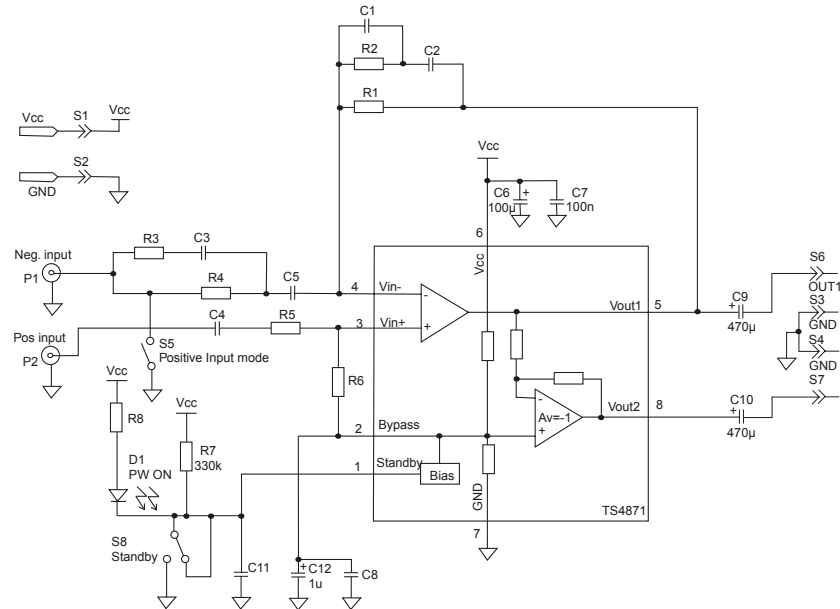

Figure 83. SO8 & MiniSO8 demoboard components side

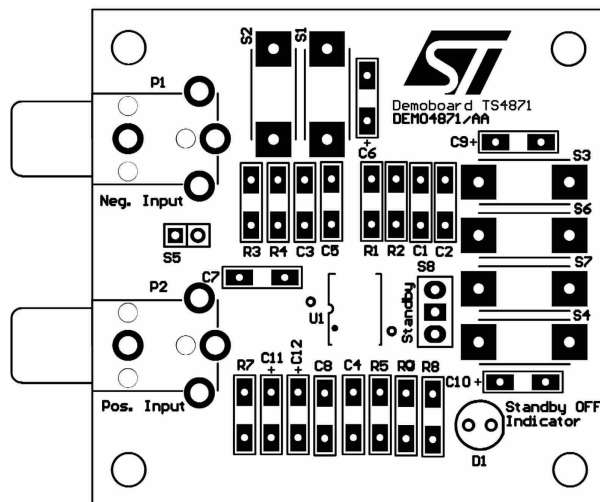
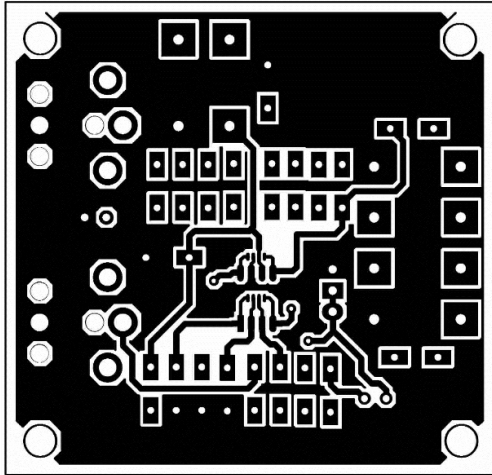
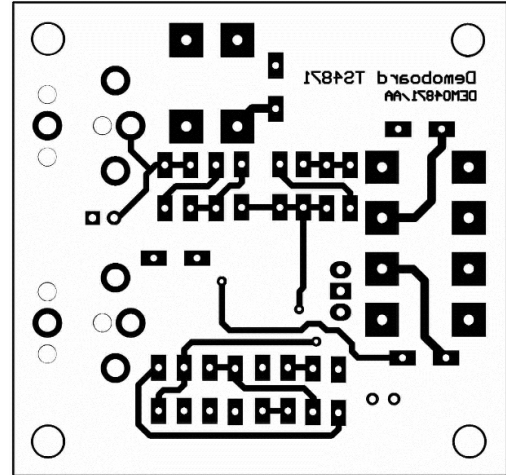

Figure 84. SO8 and MiniSO8 demoboard top solder layer

Figure 85. SO8 and MiniSO8 demoboard bottom solder layer

5.1 BTL configuration principle

The TS4871 is a monolithic power amplifier with a BTL output type. BTL (bridge tied load) means that each end of the load is connected to two single ended output amplifiers. Thus, we have:

Single ended output 1 = $V_{out1} = V_{out}$ (V)

Single ended output 2 = $V_{out2} = -V_{out}$ (V)

And $V_{out1} - V_{out2} = 2V_{out}$ (V)

The output power is:

$$P_{out} = \frac{(2V_{out_{RMS}})^2}{R_L} (W) \quad (1)$$

For the same power supply voltage, the output power in BTL configuration is four times higher than the output power in single ended configuration.

5.2 Gain In typical application schematic

In flat region (no effect of C_{in}), the output voltage of the first stage is:

$$V_{out1} = -V_{in} \frac{R_{feed}}{R_{in}} (V)$$

For the second stage : $V_{out2} = -V_{out1}$ (V)

The differential output voltage is:

$$V_{out2} - V_{out1} = 2V_{in} \frac{R_{feed}}{R_{in}} (V)$$

The differential gain named gain (G_v) for more convenient usage is:

$$G_v = \frac{V_{out2} - V_{out1}}{V_{in}} = 2 \frac{R_{feed}}{R_{in}}$$

Remark : V_{out2} is in phase with V_{in} and V_{out1} is 180 phased with V_{in} . It means that the positive terminal of the loud speaker should be connected to V_{out2} and the negative to V_{out1} .

5.3 Low and high frequency response

In low frequency region, the effect of C_{in} starts. C_{in} with R_{in} forms a high pass filter with a -3 dB cut-off frequency

$$F_{CL} = \frac{1}{2\pi R_{in} C_{in}} (\text{Hz})$$

In high frequency region, you can limit the bandwidth by adding a capacitor (C_{feed}) in parallel on R_{feed} . Its form a low pass filter with a -3 dB cut-off frequency.

$$F_{CH} = \frac{1}{2\pi R_{feed} C_{feed}} (\text{Hz})$$

5.4 Power dissipation and efficiency

Hypothesis:

- Voltage and current in the load are sinusoidal (V_{out} and I_{out})
- Supply voltage is a pure DC source (V_{cc})

Regarding the load we have:

$$V_{OUT} = V_{PEAK} \sin \omega t(t)$$

and

$$I_{OUT} = \frac{V_{OUT}}{R_L} (A)$$

$$P_{OUT} = \frac{V_{PEAK}^2}{2R_L} (W)$$

Then, the average current delivered by the supply voltage is:

$$I_{CCAVG} = 2 \frac{V_{PEAK}}{\pi R_L} (A)$$

The power delivered by the supply voltage is $P_{supply} = V_{cc} I_{CCAVG}$ (W)

Then, the power dissipated by the amplifier is $P_{diss} = P_{supply} - P_{out}$ (W)

$$P_{diss} = \frac{2\sqrt{2}V_{CC}}{\pi\sqrt{R_L}} \sqrt{P_{OUT}} - P_{OUT} (W)$$

and the maximum value is obtained when:

$$\frac{\partial P_{diss}}{\partial P_{OUT}} = 0$$

and its value is:

$$P_{dissmax} = \frac{2V_{CC}^2}{\pi^2 R_L} (W)$$

Remark : This maximum value is only depending on power supply voltage and load values.

The efficiency is the ratio between the output power and the power supply

$$\eta = \frac{P_{OUT}}{P_{supply}} = \frac{\pi V_{PEAK}}{4V_{CC}}$$

The maximum theoretical value is reached when

$V_{peak} = V_{cc}$, so

$$\frac{\pi}{4} = 78.5\%$$

5.5 Decoupling of the circuit

Two capacitors are needed to bypass properly the TS4871, a power supply bypass capacitor C_s and a bias voltage bypass capacitor C_b .

C_s has especially an influence on the THD+N in high frequency (above 7 kHz) and indirectly on the power supply disturbances.

With 100 μF , you can expect similar THD+N performances like shown in the datasheet.

If C_s is lower than 100 μF , in high frequency increases, THD+N and disturbances on the power supply rail are less filtered.

To the contrary, if C_s is higher than 100 μF , those disturbances on the power supply rail are more filtered.

C_b has an influence on THD+N in lower frequency, but its function is critical on the final result of PSRR with input grounded in lower frequency.

If C_b is lower than 1 μF , THD+N increase in lower frequency (see THD+N vs frequency curves) and the PSRR worsens up.

If C_b is higher than 1 μF , the benefit on THD+N in lower frequency is small but the benefit on PSRR is substantial (see PSRR vs. C_b curve: fig.12).

Note that C_{in} has a non-negligible effect on PSRR in lower frequency. Lower is its value, higher is the PSRR (see fig. 13).

5.6 Pop and Click performance

Pop and click performance is intimately linked to the size of the input capacitor C_{in} and the bias voltage bypass capacitor C_b .

Size of C_{in} is due to the lower cut-off frequency and PSRR value requested. Size of C_b is due to THD+N and PSRR requested always in lower frequency.

Moreover, C_b determines the speed that the amplifier turns ON. The slower the speed is, the softer the turn ON noise is.

The charge time of C_b is directly proportional to the internal generator resistance 50 $\text{k}\Omega$.

Then, the charge time constant for C_b is

$$\tau_b = 50 \text{ k}\Omega \times C_b \text{ (s)}$$

As C_b is directly connected to the non-inverting input (pin 2 and 3) and if we want to minimize, in amplitude and duration, the output spike on V_{out1} (pin 5), C_{in} must be charged faster than C_b . The charge time constant of C_{in} is

$$\tau_{in} = (R_{in} + R_{feed}) \times C_{in} \text{ (s)}$$

Thus we have the relation

$$\tau_{in} \ll \tau_b \text{ (s)}$$

The respect of this relation allows the pop and click noise to be minimized.

Remark : Minimize C_{in} and C_b has a benefit on pop and click phenomena but also on cost and size of the application.

Example : your target for the -3 dB cut off frequency is 100 Hz. With $R_{in} = R_{feed} = 22 \text{ k}\Omega$, $C_{in} = 72 \text{ nF}$ (in fact 82 nF or 100 nF).

With $C_b = 1 \mu\text{F}$, if you choose the one of the latest two values of C_{in} , the pop and click phenomena at power supply ON or standby function ON/OFF will be very small

$$50 \text{ k}\Omega \times 1 \mu\text{F} \gg 44 \text{ k}\Omega \times 100 \text{ nF} \quad (50 \text{ ms} \gg 4.4 \text{ ms}).$$

Increasing C_{in} value increases the pop and click phenomena to an unpleasant sound at power supply ON and standby function ON/OFF.

Why C_s is not important in pop and click consideration ?

Hypothesis :

$$C_s = 100 \mu\text{F}$$

$$\text{Supply voltage} = 5 \text{ V}$$

$$\text{Supply voltage internal resistor} = 0.1 \Omega$$

$$\text{Supply current of the amplifier } I_{cc} = 6 \text{ mA}$$

At power ON of the supply, the supply capacitor is charged through the internal power supply resistor. So, to reach 5 V you need about five to ten times the charging time constant of C_s ($\tau_s = 0.1 \times C_s$ (s)).

Then, this time equal 50 μs to 100 μs $\ll \tau_b$ in the majority of application.

At power OFF of the supply, C_s is discharged by a constant current I_{cc} . The discharge time from 5 V to 0 V of C_s is:

$$t_{DischC_s} = \frac{5C_s}{I_{cc}} = 83 \text{ ms}$$

Now, we must consider the discharge time of C_b .

At power OFF or standby ON, Cb is discharged by a 100 kΩ resistor. So the discharge time is about

$$t_{bDisch} \approx 3 \times C_b \times 100 \text{ k}\Omega \text{ (s)}$$

In the majority of application, Cb = 1 μF, then

$$t_{bDisch} \approx 300 \text{ ms} \gg \tau_{dischC_b}$$

5.7 Power amplifier design examples

Given :

Load impedance : 8 Ω

Output power @ 1% THD+N : 0.5 W

Input impedance : 10 kΩ min.

Input voltage peak to peak : 1 Vpp

Bandwidth frequency : 20 Hz to 20 kHz (0, -3 dB)

Ambient temperature max = 50 °C

SO8 package

First of all, we must calculate the minimum power supply voltage to obtain 0.5 W into 8 Ω. With curves in fig. 15, we can read 3.5 V. Thus, the power supply voltage value min. is 3.5 V.

Following the maximum power dissipation equation

$$P_{dissmax} = \frac{2V_{CC}^2}{\pi^2 R_L} = \left(W \right)$$

with 3.5 V we have P_{dissmax} = 0.31 W

Refer to power derating curves (fig. 20), with 0.31 W the maximum ambient temperature is 100 °C. This last value could be higher if you follow the example layout shown on the demoboard (better dissipation).

The gain of the amplifier in flat region is:

$$G_V = \frac{V_{OUTPP}}{V_{INPP}} = \frac{2\sqrt{2R_L P_{OUT}}}{V_{INPP}} = 5.65$$

We have R_{in} > 10 kΩ. Let's take R_{in} = 10 kΩ, then R_{feed} = 28.25 kΩ. We could use for R_{feed} = 30 kΩ in normalized value and the gain is G_v = 6.

In lower frequency we want 20 Hz (-3dB cut-off frequency). Then:

So, we could use for C_{in} a 1 μF capacitor value

$$C_{IN} = \frac{1}{2\pi R_{in} F_{CL}} = 795 \text{ nF}$$

which gives 16 Hz.

In higher frequency we want 20 kHz (-3dB cut off frequency). The gain bandwidth product of the TS4871 is 2 MHz typical and does not change when the amplifier delivers power into the load.

The first amplifier has a gain of:

$$\frac{R_{feed}}{R_{in}} = 3$$

and the theoretical value of the -3 dB cut-off higher frequency is 2 MHz/3 = 660 kHz.

We can keep this value or limit the bandwidth by adding a capacitor C_{feed}, in parallel on R_{feed}.

Then:

$$C_{FEED} = \frac{1}{2\pi R_{FEED} F_{CH}} = 265 \text{ pF}$$

So, we could use for C_{feed} a 220 pF capacitor value that gives 24 kHz.

Now, we can calculate the value of C_b with the formula $\tau_b = 50 \text{ k}\Omega \times C_b \gg \tau_{in} = (R_{in} + R_{feed}) \times C_{in}$ which permits to reduce the pop and click effects.

Then C_b >> 0.8 μF.

We can choose for C_b a normalized value of 2.2 μF that gives good results in THD+N and PSRR.

In the following tables, you could find three another examples with values required for the demoboard.

Remark : components with (*) marking are optional.

5.8 Application n°1 : 20 Hz to 20 kHz bandwidth and 6 dB gain BTL power amplifier

Table 7. Components

Designator	Part type
R1	22 k / 0.125 W
R4	22 k / 0.125 W
R6	Short-circuit
R7	330 k / 0.125 W
R8*	(Vcc-Vf_led) / If_led
C5	470 nF
C6	100 µF
C7	100 nF
C9	Short-circuit
C10	Short-circuit
C12	1 µF
S1, S2, S6, S7	2 mm insulated plug 10.16 mm pitch
S8	3 pt connector 2.54 mm pitch
P1	PCB phono Jack
D1*	Led 3 mm
U1	TS4871ID or TS4871IS

5.9 Application n°2 : 20 Hz to 20 kHz bandwidth and 20 dB gain BTL power amplifier

Table 8. Components

Designator	Part type
R1	110 k / 0.125 W
R4	22 k / 0.125 W
R6	Short-circuit
R7	330 k / 0.125 W
R8*	$(V_{cc} - V_{f_led}) / I_{f_led}$
C5	470 nF
C6	100 μ F
C7	100 nF
C9	Short-circuit
C10	Short-circuit
C12	1 μ F
S1, S2, S6, S7	2 mm insulated plug 10.16 mm pitch
S8	3 pt connector 2.54 mm pitch
P1	PCB phono Jack
D1*	Led 3 mm
U1	TS4871ID or TS4871IS

5.10 Application n° 3: 50 Hz to 10 kHz bandwidth and 10 dB gain BTL power amplifier

Table 9. Components

Designator	Part type
R1	33 k / 0.125 W
R2	Short-circuit
R4	22 k / 0.125 W
R6	Short-circuit
R7	330 k / 0.125 W
R8*	$(V_{cc}-V_{f_led}) / I_{f_led}$
C2	470 pF
C5	150 nF
C6	100 μ F
C7	100 nF
C9	Short-circuit
C10	Short-circuit
C12	1 μ F
S1, S2, S6, S7	2 mm insulated plug 10.16 mm pitch
S8	3 pts connector 2.54 mm pitch
P1	PCB phono Jack
D1*	Led 3 mm
U1	TS4871ID or TS4871IS

5.11 Application n°4 : Differential inputs BTL power amplifier

In this configuration, we need to place these components : R1, R4, R5, R6, R7, C4, C5, C12.

We have also : R4 = R5, R1 = R6, C4 = C5.

The gain of the amplifier is:

$$G_{VDIFF} = 2 \frac{R1}{R4}$$

For Vcc = 5 V, a 20 Hz to 20 kHz bandwidth and 20 dB gain BTL power amplifier you could follow the bill of material below.

Table 10. Components

Designator	Part type
R1	110 k / 0.125 W
R4	22 k / 0.125 W
R5	22 k / 0.125 W
R6	110 k / 0.125 W
R7	330 k / 0.125 W
R8*	(Vcc-Vf_led) / If_led
C4	470 nF
C5	470 nF
C6	100 µF
C7	100 nF
C9	Short-circuit
C10	Short-circuit
C12	1 µF
D1*	Led 3 mm
S1, S2, S6, S7	2 mm insulated plug 10.16 mm pitch
S8	3 pts connector 2.54 mm pitch
P1, P2	PCB phono Jack
U1	TS4871ID or TS4871IS

5.12 Note on how to use the PSRR curves

We have finished a design and we have chosen the components values

- Rin=Rfeed=22 kΩ
- Cin=100 nF
- Cb=1 µF

Now, on fig. 13, we can see the PSRR (input grounded) vs. frequency curves. At 217 Hz we have a PSRR value of -36 dB.

In reality we want a value about -70 dB. So, we need a gain of 34 dB.

Now, on fig. 12 we can see the effect of Cb on the PSRR (input grounded) vs. frequency. With Cb=100 µF, we can reach the -70 dB value.

The process to obtain the final curve (Cb=100 µF, Cin=100 nF, Rin=Rfeed=22 kΩ) is a simple transfer point by point on each frequency of the curve on fig. 13 to the curve on fig. 12. The measurement result is shown on the next figure.

Figure 86. PSRR changes with Cb

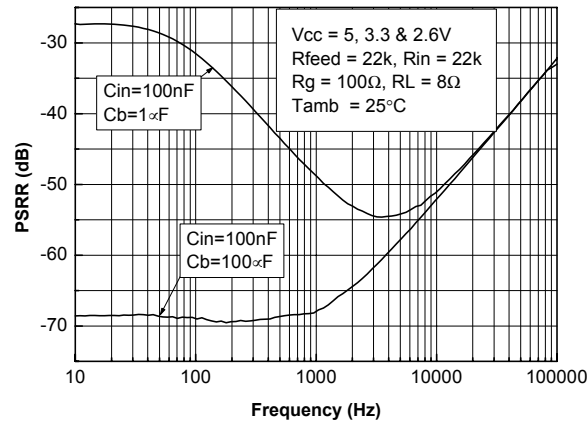

What is the PSRR?

The PSRR is the power supply rejection ratio. It is a kind of SVR in a determined frequency range.

The PSRR of a device, is the ratio between a power supply disturbance and the result on the output. We can say that the PSRR is the ability of a device to minimize the impact of power supply disturbances to the output.

How do we measure the PSRR?

Figure 87. PSRR measurement schematic

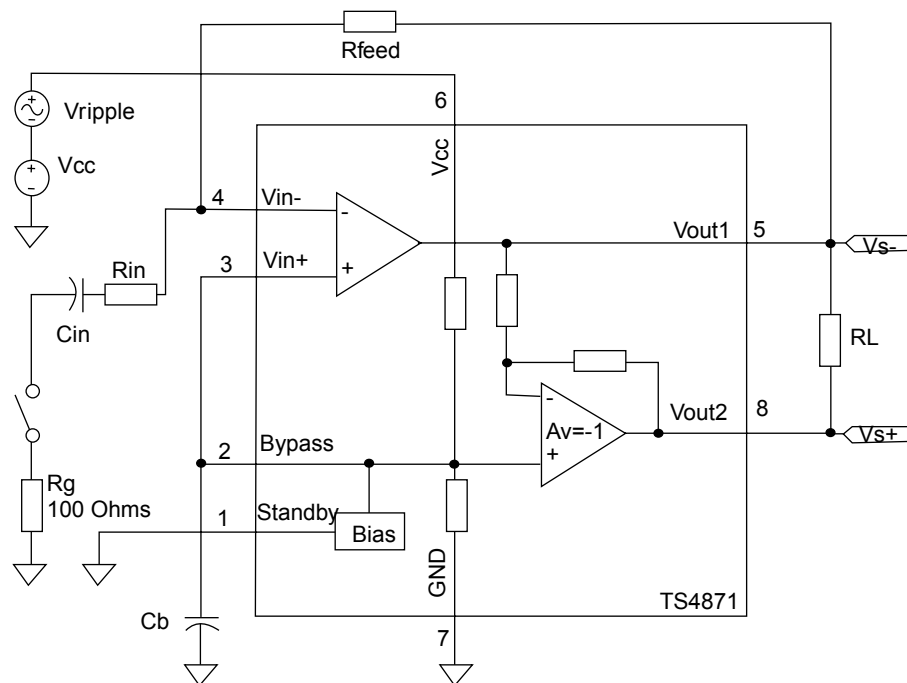

5.13 Principle of operation

We fixed the DC voltage supply (V_{cc}), the AC sinusoidal ripple voltage (V_{ripple}) and no supply capacitor C_s is used.

The PSRR value for each frequency is:

$$PSRR(dB) = 20 \times \log_{10} \left[\frac{Rms(V_{ripple})}{Rms(V_{s+} - V_{s-})} \right]$$

Remark : The measure of the Rms voltage is not a Rms selective measure but a full range (2 Hz to 125 kHz) Rms measure.

It means that we measure the effective Rms signal + the noise.

5.14 High/low cut-off frequencies

For their calculation, please check the figure below:

Figure 88. Frequency response gain vs C_{in} and C_{feed}

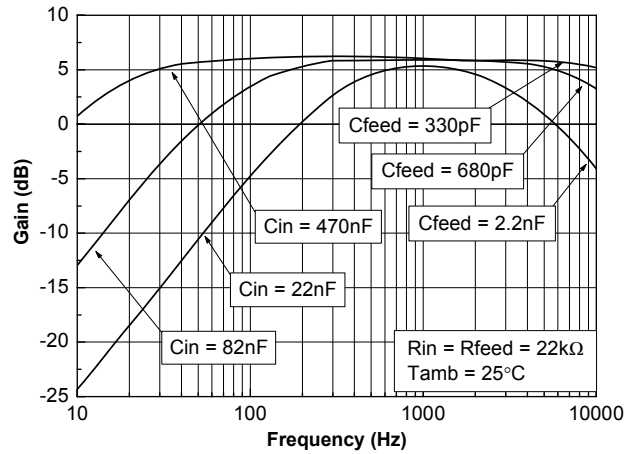

6 Package information

In order to meet environmental requirements, ST offers these devices in different grades of **ECOPACK** packages, depending on their level of environmental compliance. ECOPACK specifications, grade definitions and product status are available at: www.st.com. ECOPACK is an ST trademark.

6.1 MiniSO8 package information

Figure 89. MiniSO8 package outline

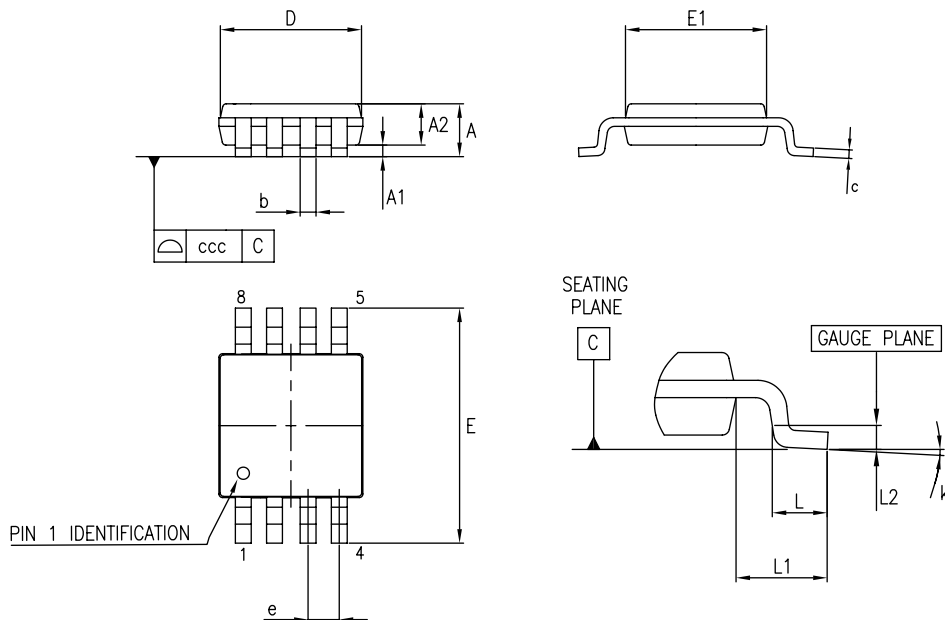

Table 11. MiniSO8 mechanical data

Dim.	Millimeters			Inches		
	Min.	Typ.	Max.	Min.	Typ.	Max.
A			1.1			0.043
A1	0		0.15	0		0.006
A2	0.75	0.85	0.95	0.03	0.033	0.037
b	0.22		0.4	0.009		0.016
c	0.08		0.23	0.003		0.009
D	2.8	3	3.2	0.11	0.118	0.126
E	4.65	4.9	5.15	0.183	0.193	0.203
E1	2.8	3	3.1	0.11	0.118	0.122
e		0.65			0.026	
L	0.4	0.6	0.8	0.016	0.024	0.031
L1		0.95			0.037	
L2		0.25			0.01	
k	0°		8°	0°		8°
ccc			0.1			0.004

6.2 SO8 package information

Figure 90. SO-8 package outline

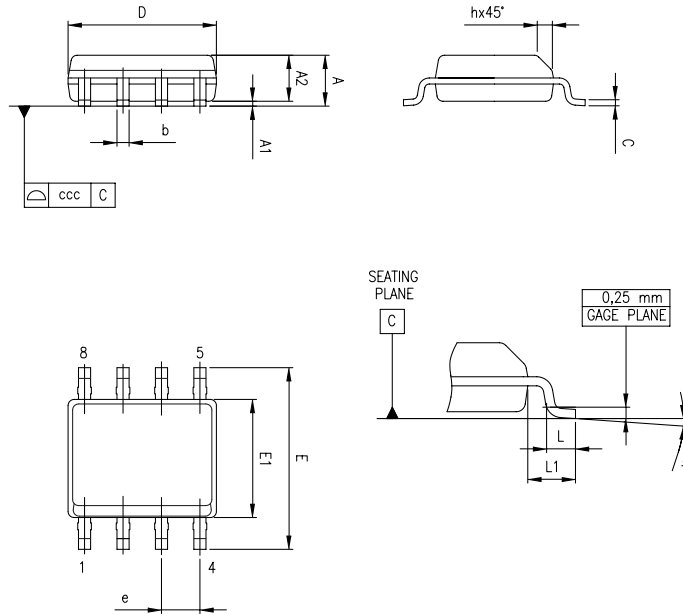

Table 12. SO-8 package mechanical data

Ref.	Dimensions					
	Millimeters			Inches		
	Min.	Typ.	Max.	Min.	Typ.	Max.
A			1.75			0.069
A1	0.10		0.25	0.04		0.010
A2	1.25			0.049		
b	0.28	0.40	0.48	0.011	0.016	0.019
c	0.17		0.23	0.007		0.010
D	4.80	4.90	5.00	0.189	0.193	0.197
E	5.80	6.00	6.20	0.228	0.236	0.244
E1	3.80	3.90	4.00	0.150	0.154	0.157
e		1.27			0.050	
h	0.25		0.50	0.010		0.020
L	0.40	0.635	1.27	0.016		0.050
L1		1.04			0.040	
k	1°		8°	1°		8°
ccc			0.10			0.004

7 Ordering information

Table 13. Ordering information

Order code	Temperature range	Package	Packing	Marking
TS4871IST	-40, +85°C	MiniSO8	Tape and reel	4871I
TS4871IDT		SO8		4871
TS4871ID		SO8	Tube	4871

Revision history

Table 14. Document revision history

Date	Revision	Changes
08-May-2019	9	No history because of migration. Removed the part number TS4871Q1T and all its reference throughout the document.

Contents

1	Pin configuration	2
2	Maximum ratings	3
3	Electrical characteristics	4
4	Electrical characteristics curves	7
5	Application information	26
5.1	BTL configuration principle	27
5.2	Gain In typical application schematic	27
5.3	Low and high frequency response	28
5.4	Power dissipation and efficiency	28
5.5	Decoupling of the circuit	28
5.6	Pop and Click performance	29
5.7	Power amplifier design examples	30
5.8	Application n°1 : 20 Hz to 20 kHz bandwidth and 6 dB gain BTL power amplifier	31
5.9	Application n°2 : 20 Hz to 20 kHz bandwidth and 20 dB gain BTL power amplifier	32
5.10	Application n° 3: 50 Hz to 10 kHz bandwidth and 10 dB gain BTL power amplifier	33
5.11	Application n°4 : Differential inputs BTL power amplifier	34
5.12	Note on how to use the PSRR curves	34
5.13	Principle of operation	35
5.14	High/low cut-off frequencies	36
6	Package information	37
6.1	MiniSO8 package information	38
6.2	SO8 package information	39
7	Ordering information	40
	Revision history	41

List of tables

Table 1.	Absolute maximum ratings	3
Table 2.	Operating conditions	3
Table 3.	Electrical characteristics $V_{CC} = +5\text{ V}$, $GND = 0\text{ V}$, $T_{amb} = 25\text{ }^{\circ}\text{C}$ (unless otherwise specified).	4
Table 4.	Electrical characteristics $V_{CC} = +3.3\text{ V}$, $GND = 0\text{ V}$, $T_{amb} = 25\text{ }^{\circ}\text{C}$ (unless otherwise specified)	5
Table 5.	Electrical characteristics $V_{CC} = +2.6\text{ V}$, $GND = 0\text{ V}$, $T_{amb} = 25\text{ }^{\circ}\text{C}$ (unless otherwise specified).	5
Table 6.	Bill of material	6
Table 7.	Components	31
Table 8.	Components	32
Table 9.	Components	33
Table 10.	Components	34
Table 11.	MiniSO8 mechanical data	38
Table 12.	SO-8 package mechanical data	39
Table 13.	Ordering information.	40
Table 14.	Document revision history	41

List of figures

Figure 1.	Pin connections (top view)	2
Figure 2.	Open loop frequency response $V_{CC}=5\text{ V}$	7
Figure 3.	Open loop frequency response $Z_L=8\ \Omega$	7
Figure 4.	Open loop frequency response $V_{CC}=3.3\text{ V}$	7
Figure 5.	Open loop frequency response $V_{CC}=3.3\text{ V}$, $Z_L=8\ \Omega$	7
Figure 6.	Open loop frequency response $V_{CC}=2.6\text{ V}$	8
Figure 7.	Open loop frequency response $V_{CC}=2.6\text{ V}$, $Z_L=8\ \Omega$	8
Figure 8.	Open loop frequency response $V_{CC}=5\text{ V}$, $C_L=560\text{ pF}$	8
Figure 9.	Open loop frequency response $V_{CC}=3.3\text{ V}$, $C_L=560\text{ pF}$	8
Figure 10.	Open loop frequency response $V_{CC}=2.6\text{ V}$, $C_L=560\text{ pF}$	8
Figure 11.	Power supply rejection ratio (PSRR) vs power supply	8
Figure 12.	Power supply rejection ratio (PSRR) vs feedback capacitor	9
Figure 13.	Power supply rejection ratio (PSRR) vs bypass capacitor	9
Figure 14.	Power supply rejection ratio (PSRR) vs input capacitor	9
Figure 15.	Power supply rejection ratio (PSRR) vs feedback resistor	9
Figure 16.	P_{out} @ THD + N = 1% vs supply voltage vs R_L	10
Figure 17.	P_{out} @ THD + N = 10% vs supply voltage vs R_L	10
Figure 18.	Power dissipation vs P_{out} $V_{CC}=5\text{ V}$	10
Figure 19.	Power dissipation vs P_{out} $V_{CC}=3.3\text{ V}$	10
Figure 20.	Power dissipation vs P_{out} $V_{CC}=2.6\text{ V}$	10
Figure 21.	Power derating curves	10
Figure 22.	THD + N vs output power $G_v=2$, $V_{CC}=5\text{ V}$	11
Figure 23.	THD + N vs output power $G_v=10$, $V_{CC}=5\text{ V}$	11
Figure 24.	THD + N vs output power $G_v=2$, $V_{CC}=3.3\text{ V}$	11
Figure 25.	THD + N vs output power $G_v=10$, $V_{CC}=3.3\text{ V}$	11
Figure 26.	THD + N vs output power $G_v=2$, $V_{CC}=2.6\text{ V}$	12
Figure 27.	THD + N vs output power $G_v=10$, $V_{CC}=2.6\text{ V}$	12
Figure 28.	THD + N vs output power $G_v=2$, $V_{CC}=5\text{ V}$, $R_L=8\ \Omega$	12
Figure 29.	THD + N vs output power $G_v=10$, $V_{CC}=5\text{ V}$	12
Figure 30.	THD + N vs output power $R_L=8\ \Omega$	13
Figure 31.	THD + N vs output power $R_L=8\ \Omega$, $V_{CC}=3.3\text{ V}$	13
Figure 32.	THD + N vs output power $R_L=8\ \Omega$, $V_{CC}=2.6\text{ V}$	13
Figure 33.	THD + N vs output power $R_L=8\ \Omega$, $G_v=10$	13
Figure 34.	THD + N vs output power $G_v=2$, $V_{CC}=5\text{ V}$, $C_b=0.1\ \mu\text{F}$	14
Figure 35.	THD + N vs output power $G_v=10$, $V_{CC}=5\text{ V}$, $C_b=0.1\ \mu\text{F}$	14
Figure 36.	THD + N vs output power $G_v=2$, $V_{CC}=3.3\text{ V}$, $C_b=0.1\ \mu\text{F}$	14
Figure 37.	THD + N vs output power $G_v=10$, $V_{CC}=3.3\text{ V}$, $C_b=0.1\ \mu\text{F}$	14
Figure 38.	THD + N vs output power $G_v=2$, $V_{CC}=2.6\text{ V}$, $C_b=0.1\ \mu\text{F}$	15
Figure 39.	THD + N vs output power $G_v=10$, $V_{CC}=2.6\text{ V}$, $C_b=0.1\ \mu\text{F}$	15
Figure 40.	THD + N vs output power $R_L=16\ \Omega$ $V_{CC}=0.5\text{ V}$	15
Figure 41.	THD + N vs output power $R_L=16\ \Omega$ $G_v=10$	15
Figure 42.	THD + N vs output power $R_L=16\ \Omega$, $G_v=2$	16
Figure 43.	THD + N vs output power $R_L=16\ \Omega$, $G_v=10$, $V_{CC}=3.3\text{ V}$	16
Figure 44.	THD + N vs output power $R_L=16\ \Omega$ $V_{CC}=2.6\text{ V}$	16
Figure 45.	THD + N vs output power $R_L=16\ \Omega$, $V_{CC}=2.6\text{ V}$, $G_v=10$	16
Figure 46.	THD + N vs frequency	17
Figure 47.	THD + N vs frequency, $V_{CC}=5\text{ V}$	17
Figure 48.	THD + N vs frequency, $V_{CC}=3.3\text{ V}$	17
Figure 49.	THD + N vs frequency, $G_v=10$	17
Figure 50.	THD + N vs frequency, $V_{CC}=2.6\text{ V}$	18
Figure 51.	THD + N vs frequency, $V_{CC}=2.6\text{ V}$, $R_L=4\ \Omega$	18
Figure 52.	THD + N vs frequency, $V_{CC}=5\text{ V}$, $R_L=8\ \Omega$	18

Figure 53.	THD + N vs frequency, Pout=450 mW	18
Figure 54.	THD + N vs frequency, Pout=900 mW	19
Figure 55.	THD + N vs frequency, Pout=450 mW, RL=8 Ω	19
Figure 56.	THD + N vs frequency, Pout=400 mW	19
Figure 57.	THD + N vs frequency, Pout=200 mW	19
Figure 58.	THD + N vs frequency, Pout=400 mW, Gv=010.	20
Figure 59.	THD + N vs frequency, Pout=200 mW	20
Figure 60.	THD + N vs frequency, Pout=220 mW	20
Figure 61.	THD + N vs frequency, Pout=110 mW	20
Figure 62.	THD + N vs frequency, Pout=220 mW, Vcc= 2.6 V	21
Figure 63.	THD + N vs frequency, Pout=110 mW, Vcc= 2.6 V.	21
Figure 64.	THD + N vs frequency, RL=16 Ω	21
Figure 65.	THD + N vs frequency, RL=16 Ω , Gv=10.	21
Figure 66.	THD + N vs frequency, RL=16 Ω , Gv=2.	22
Figure 67.	THD + N vs frequency, RL=16 Ω , Gv=10, Vcc=3.3 V.	22
Figure 68.	THD + N vs frequency, RL=16 Ω , Gv=2, Vcc=2.6 V	22
Figure 69.	THD + N vs frequency, RL=16 Ω , Gv=10, Pout= 160 mW	22
Figure 70.	Signal-to-noise ratio vs power supply with unweighted filter (20 Hz to 20 kHz).	23
Figure 71.	Signal-to-noise ratio vs power supply with weighted filter type A	23
Figure 72.	Signal-to-noise ratio vs power supply with weighted filter type A Gv=2.	23
Figure 73.	Current consumption vs power supply voltage	23
Figure 74.	Signal-to-noise ratio vs power supply with unweighted filter (20 Hz to 20 kHz) Gv=10	24
Figure 75.	Current consumption vs standby voltage @ Vcc = 5 V	24
Figure 76.	Current consumption vs standby voltage @ Vcc = 2.6 V	24
Figure 77.	Current consumption vs standby voltage @ Vcc = 3.3 V	24
Figure 78.	Clipping voltage vs power supply voltage and load resistor.	25
Figure 79.	Clipping voltage low-side vs power supply voltage and load resistor	25
Figure 80.	Vout1+Vout2 unweighted noise floor	25
Figure 81.	Vout1+Vout2 A-weighted noise floor	25
Figure 82.	Demoboard schematic.	26
Figure 83.	SO8 & MiniSO8 demoboard components side	26
Figure 84.	SO8 and MiniSO8 demoboard top solder layer	27
Figure 85.	SO8 and MiniSO8 demoboard bottom solder layer	27
Figure 86.	PSRR changes with Cb	35
Figure 87.	PSRR measurement schematic	35
Figure 88.	Frequency response gain vs Cin and Cfeed	36
Figure 89.	MiniSO8 package outline	38
Figure 90.	SO-8 package outline	39

IMPORTANT NOTICE – PLEASE READ CAREFULLY

STMicroelectronics NV and its subsidiaries (“ST”) reserve the right to make changes, corrections, enhancements, modifications, and improvements to ST products and/or to this document at any time without notice. Purchasers should obtain the latest relevant information on ST products before placing orders. ST products are sold pursuant to ST’s terms and conditions of sale in place at the time of order acknowledgement.

Purchasers are solely responsible for the choice, selection, and use of ST products and ST assumes no liability for application assistance or the design of Purchasers’ products.

No license, express or implied, to any intellectual property right is granted by ST herein.

Resale of ST products with provisions different from the information set forth herein shall void any warranty granted by ST for such product.

ST and the ST logo are trademarks of ST. For additional information about ST trademarks, please refer to www.st.com/trademarks. All other product or service names are the property of their respective owners.

Information in this document supersedes and replaces information previously supplied in any prior versions of this document.

© 2019 STMicroelectronics – All rights reserved



Компания «ЭлектроПласт» предлагает заключение долгосрочных отношений при поставках импортных электронных компонентов на взаимовыгодных условиях!

Наши преимущества:

- Оперативные поставки широкого спектра электронных компонентов отечественного и импортного производства напрямую от производителей и с крупнейших мировых складов;
- Поставка более 17-ти миллионов наименований электронных компонентов;
- Поставка сложных, дефицитных, либо снятых с производства позиций;
- Оперативные сроки поставки под заказ (от 5 рабочих дней);
- Экспресс доставка в любую точку России;
- Техническая поддержка проекта, помощь в подборе аналогов, поставка прототипов;
- Система менеджмента качества сертифицирована по Международному стандарту ISO 9001;
- Лицензия ФСБ на осуществление работ с использованием сведений, составляющих государственную тайну;
- Поставка специализированных компонентов (Xilinx, Altera, Analog Devices, Intersil, Interpoint, Microsemi, Aeroflex, Peregrine, Syfer, Eurofarad, Texas Instrument, Miteq, Cobham, E2V, MA-COM, Hittite, Mini-Circuits, General Dynamics и др.);

Помимо этого, одним из направлений компании «ЭлектроПласт» является направление «Источники питания». Мы предлагаем Вам помощь Конструкторского отдела:

- Подбор оптимального решения, техническое обоснование при выборе компонента;
- Подбор аналогов;
- Консультации по применению компонента;
- Поставка образцов и прототипов;
- Техническая поддержка проекта;
- Защита от снятия компонента с производства.



Как с нами связаться

Телефон: 8 (812) 309 58 32 (многоканальный)

Факс: 8 (812) 320-02-42

Электронная почта: org@eplast1.ru

Адрес: 198099, г. Санкт-Петербург, ул. Калинина, дом 2, корпус 4, литера А.