

# EE-SX3173/4173-P Series

## Built-in Photomicrosensor Connector Type

- Mounted with M3 screws
- 5 VDC and 24 VDC power supply types are available
- Photo IC output (Dark-ON/Light-ON)
- Connector with secure lock compatible with JST GHR-03
- Equipped with a Zener diode, which increases noise immunity (for EE-SX3173/4173-P3-Z only)
- Connector with cable is also available (order separately) EE-5002 1M (Refer to page 7.)

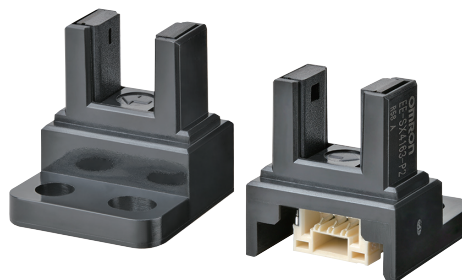

 Be sure to read Safety Precautions on page 4.

## Features

### Models available

Power supply voltage: In addition to the conventional 5 VDC supply, model also available with 24 VDC supply best for large devices

Mounting: New model available with M3 screws

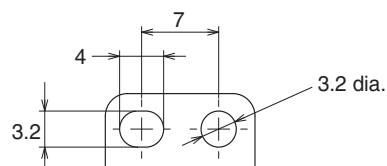
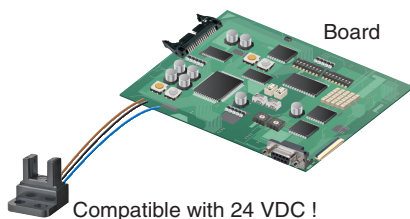

### Downsizing

Smallest class in the industry \*: Downsizing of products with unique optical elements is realized  
\* As of August 2018, according to research by our company

### Environment resistance

Connection: Equipped with connectors with locks for resistance against vibration and shock

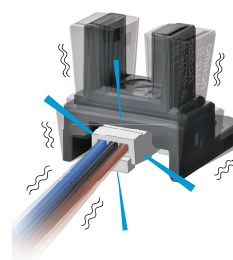
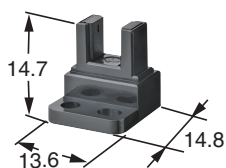

## Application Examples



Packaging Machine



Analysis and Measurement Equipment

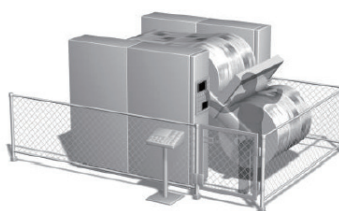

Printing Equipment





ATM

## Model Number Structure

EE-SX□□□□-P□-□  
 (1)(2)(3)(4)(5) (6) (7)

- (1) Sensing method  
X: Transmissive
- (2) Operating mode  
3: Dark-ON  
4: Light-ON
- (3) Structure  
1: Standard structure
- (4) Mounting screw size  
7: M3
- (5) Appearance  
3: L-shaped mounting
- (6) Power supply voltage  
2: 5 VDC  
3: 24 VDC
- (7) Protection circuit  
Z: Available

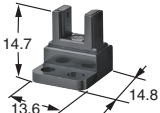
## Ordering Information

Appearance	Sensing method	Connecting method	Sensing distance	Aperture size H x W (mm)	Output type	Power supply voltage	Operating mode	Model
	Transmissive (slot type)	Connector	 <b>5 mm</b> (Slot width)	Emitter 1.4 × 1.4  Detector 1.4 × 0.5	Photo IC	24 VDC	Dark-ON	EE-SX3173-P3-Z
							Light-ON	EE-SX4173-P3-Z
						5 VDC	Dark-ON	EE-SX3173-P2
							Light-ON	EE-SX4173-P2

## Ratings, Characteristics and Exterior Specifications

### Absolute Maximum Ratings (Ta = 25°C)

Item	Symbol	Rated value		Unit	Remarks
		EE-SX3173-P3-Z EE-SX4173-P3-Z	EE-SX3173-P2 EE-SX4173-P2		
Power supply voltage	V <sub>CC</sub>	26.4 DC	5.5 DC	V	---
Output voltage	V <sub>OUT</sub>	26.4	13.2	V	---
Output current	I <sub>OUT</sub>	16		mA	---
Permissible output power dissipation	P <sub>OUT</sub>	80		mW	Fig 1.
Operating temperature	T <sub>opr</sub>	-25 to +55		°C	*
Storage temperature	T <sub>stg</sub>	-30 to +80		°C	*
Soldering temperature	T <sub>sol</sub>	---		°C	---

\* Reduce the voltage and current, if necessary, by reference to the temperature rating chart (Fig. 1.), even if the temperature is within the specified range. The product should be used without freezing or condensation.

### Exterior Specifications

Appearance		L-shaped mounting
Item		EE-SX3173-P3-Z EE-SX4173-P3-Z EE-SX3173-P2 EE-SX4173-P2
Connecting method		Connector
Weight		Approx. 1.5 g
Materials	Case	Polybutylene terephthalate (PBT)
	Emitter/receiver	Polyphenylene sulfide (PPS) fiber

### Electrical and Optical Characteristics (Ta = 25°C)

Item	Symbol	Value	
		24 VDC model	5 VDC model
	Dark-ON	EE-SX3173-P3-Z	EE-SX3173-P2
	Light-ON	EE-SX4173-P3-Z	EE-SX4173-P2
Power supply voltage	V <sub>CC</sub>	24 ±10%V Ripple (p-p) 10%	5 ±10%V Ripple (p-p) 10%
Current consumption	I <sub>CC</sub>	15 mA max. (With and without incident)	25 mA max. (With and without incident)
Low-level output voltage	V <sub>OL</sub>	0.3 V max. (I <sub>OUT</sub> = 16 mA) (Dark-ON: Without incident, Light-ON: With incident)	
High-level output voltage	V <sub>OH</sub>	(V <sub>CC</sub> × 0.9 V min. (V <sub>OUT</sub> = V <sub>CC</sub> , R <sub>L</sub> = 47 kΩ)) (Dark-ON: With incident, Light-ON: Without incident)	
Sensing object	---	1.4 × 0.5 min. *1	
Response frequency	f	3kHz min. (V <sub>OUT</sub> = V <sub>CC</sub> , I <sub>OUT</sub> = 16 mA *2)	
Operating ambient light	---	1000 lx max. *3	
Peak emission wavelength	λ <sub>P</sub>	855 nm	940 nm

\*1. Objects that do not allow infrared light to pass through them.  
 \*2. The value of the response frequency is measured by rotating the disk as shown below.

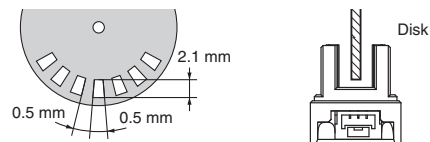

\*3. When fluorescent light is used.

## Engineering Data (Reference Value)

**Fig 1. Output Allowable Dissipation vs. Ambient Temperature Characteristics**

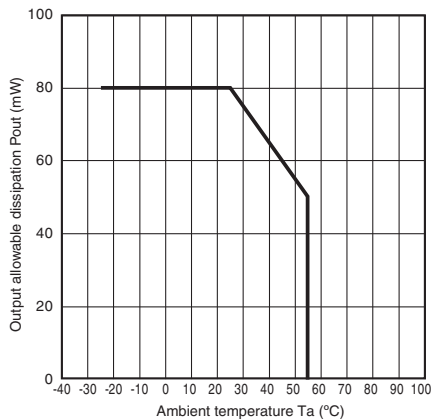

**Fig 2. Sensing Position Characteristics (Typical)**

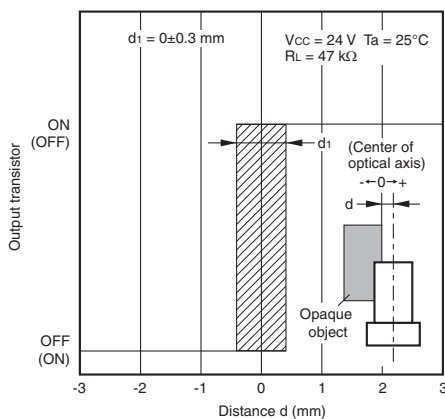

**Fig 3. Sensing Position Characteristics (Typical)**

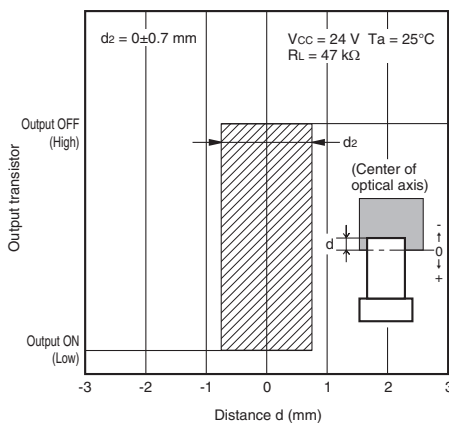

**Fig 4. Repeated Sensing Position Characteristics**

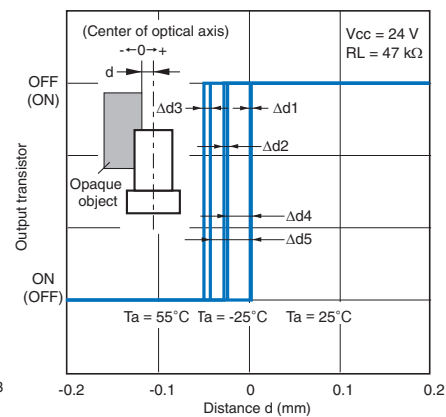

$V_{CC} = 24$  V, No. of repetitions: 20  
 $\Delta d_1 = 0.001$  mm,  $\Delta d_2 = 0.004$  mm,  
 $\Delta d_3 = 0.007$  mm,  $\Delta d_4 = 0.026$  mm,  
 $\Delta d_5 = 0.045$  mm

**Note:** The data applies to dark status.  
 Operation may be affected by external light interference or light coming through the sensing object.

## Safety Precautions

To ensure safe operation, be sure to read and follow the Instruction Manual provided with the sensor.

### WARNING

This product cannot be used as a safety device for press machines or for protecting the safety of persons. This product is designed for use in applications for sensing workpieces and workers that do not affect safety.



### CAUTION

This product is not designed or rated for ensuring safety of persons either directly or indirectly. Do not use it for such purposes.



### Precautions for Safe Use

Be sure to observe the following precautions to ensure safety.

#### Wiring

##### Power Supply Voltage

Do not exceed the operating voltage and current ranges. Applying a voltage or current exceeding the operating range or using an AC power supply for the DC power supply sensor may result in rupture or burning.

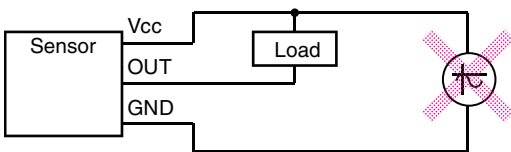

##### Load Short-circuit

Do not short-circuit the load. Doing so may result in rupture or burning.

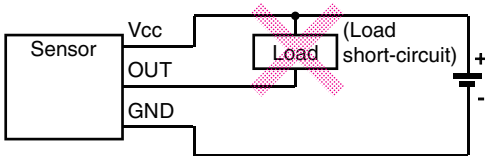

##### Faulty Wiring

Do not make a mistake with the wiring, such as reversing the power supply polarity. Doing so may result in rupture or burning.

Typical example 1) Wrong polarity

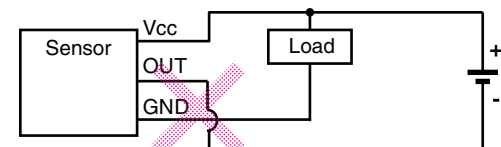
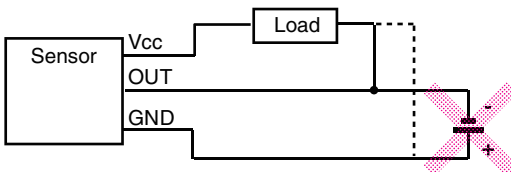
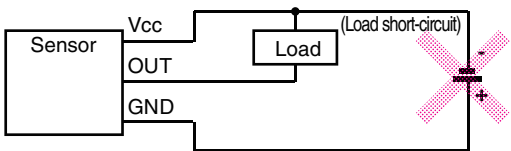

##### Connection without a Load

If the power supply is connected directly without a load, the internal elements may explode or burn. Be sure to insert a load when connecting the power supply.

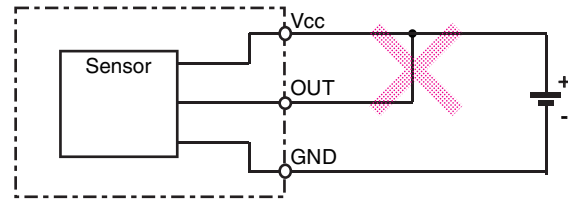

##### AND Connection

With an AND connection as shown in the figure below, a voltage is applied to Vcc while GND of sensor 2 is not securely grounded. A failure may occur. Do not make this kind of connection. Also in some models, an inrush current may occur in sensor 2 when sensor 1 is turned on, causing failure or malfunction.

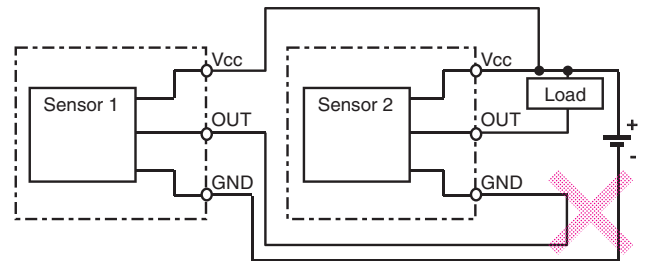

##### Storage and Operating Environment

1. Places where the product is not exposed to corrosive gases, such as hydrogen sulfide gas, or salty wind.
2. Places where it is not exposed to direct sunlight.
3. Make sure that flux, oil, or other chemicals do not adhere to the surface of the emitter and receiver.
4. Do not apply a load that may deform or deteriorate the product in any circumstances.
5. Store the product in a normal temperature, humidity, and pressure environment.
6. The product should be used without freezing or condensation.
7. Do not use the product in atmospheres or environments that exceed product ratings.
8. This product does not have a water-proof or dust-proof structure. Therefore, do not use it in an application or environment where it will be subjected to dust or splashes from water, oil, or any other liquid.

**Precautions for Correct Use**

**Mounting**

1. This product is intended to be built into devices so no special measures have been taken against external light interference. When using a DC light sensor in an area exposed to an incandescent lamp or other external light interference, it should be mounted so that the effects of external light interference can be avoided.
2. Mount the sensor securely on a flat surface.
3. Use M3 screws to secure the Photomicro Sensor (use together with spring washers and 6-mm-diameter flat washers to prevent screws from loosening). Use a tightening torque of 0.54 N·m max.
4. Take care that nothing comes into contact with the sensing element of the sensor. Damage to the sensing element will result in poor performance.
5. Before using the sensor, check to make sure that it has not become loose due to vibration or shock.

**Wiring**

**Surge Prevention**

1. If there is a surge in the power supply, try connecting a Zener diode (ZD with a voltage of 30 to 35 V) or a capacitor (with a capacitance of 0.1 to 1 μF), depending on the operating environment. Use the sensor only after confirming that the surge has been removed.

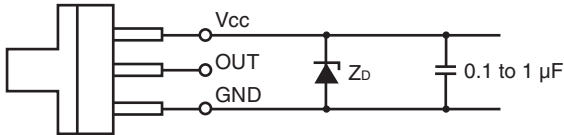

Z<sub>D</sub>: Zener diode

2. Do not use a small inductive load, such as a relay.

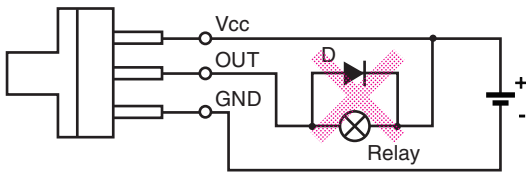

3. If photomicrosensor wires are placed in the same tubes or ducts as high-voltage lines or power lines, induction may cause malfunction or damage. Either wire the photomicrosensor separately or place the wires in separate tubes.
4. Make sure that connectors (commercially available) are securely locked.

**Voltage Output**

A sensor with an open collector output can be connected to a counter with a voltage input by connecting a resistor between the power supply and output. Select a resistor with reference to the following example. The resistance of the resistor is normally 4.7 kΩ. The wattage of the resistor is 0.5 W at a power supply voltage of 24 V.

1. A sensor with an open collector output can be connected to a counter with a voltage input by connecting a resistor between the power supply and output. Select a resistor with reference to the following example. The resistance of the resistor is normally 4.7 kΩ. The wattage of the resistor is 0.5 W at a power supply voltage of 24 V.

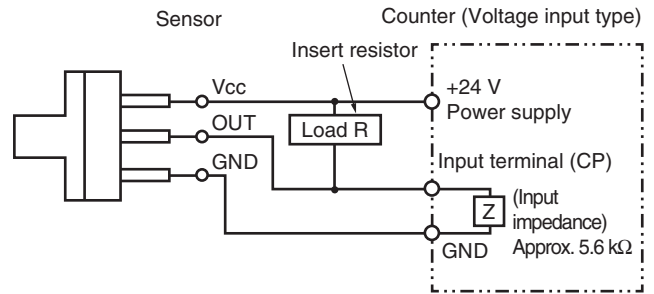

Example: EE-SX4173-P3-Z

When inserting a load resistor (R = 5.6 kΩ) in the following device

**Counter Specifications**

Input impedance	5.6 kΩ
Voltage judged as high level (input ON)	4.5 to 30 VDC
Voltage judged as low level (input OFF)	0 to 2 VDC

The high and low levels are found using the following formulas. The input device specifications must satisfy both formulas.

High level:

$$\text{Input voltage } V_H = \frac{Z}{R+Z} V_{CC} = \frac{5.6 \text{ k}}{4.7 \text{ k} + 5.6 \text{ k}} \times 24 \text{ V} = 13 \text{ V}$$

Low level:

$$\text{Output current } I_{out} = \frac{V_{CC}}{R} = \frac{24 \text{ V}}{4.7 \text{ k}} = 5.1 \text{ mA} \leq 16 \text{ mA}$$

Input voltage  $V_L \leq 0.3 \text{ V}$

(Low-level output voltage  $V_{OL}$  at an output current (I<sub>out</sub>) of 16 mA)

**Note:** Refer to the ratings of the sensor for the residual voltage of the load current.

**Handling during Wiring**

1. If a force is applied to the connection area between the terminal and connector by bending or pulling the cable after the wiring is completed, the connector contact part or connection area with the cable may be damaged, resulting in contact failure. Make sure that a stress (external force) as shown in the figure below is not applied to the connection area between the terminal and connector when routing and connecting cables or harnesses.

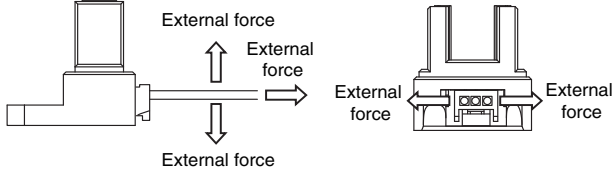

2. Do not perform cord wiring when power supply voltage is applied. Doing so may result in damage.

**Other Precautions**

Make sure the total length of the power cable connected to the product is less than 10 m.

**Design**

Design should be made so that light is completely shut off during operation. We recommend that sensing objects are made of metal. (With an infrared light sensor, infrared light will pass through the sensing object made of resin, resulting in unstable detection.)

**Connection with PLC (NPN Open Collector Type)**

Mounting should be carried out by reference to the figure below.

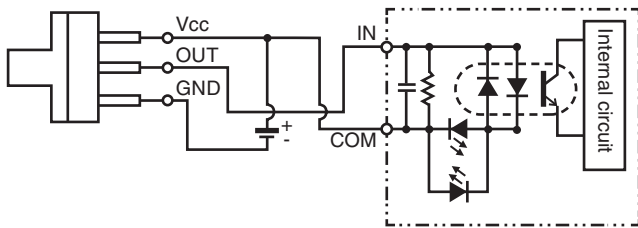

**Connection with Counter (NPN Open Collector Type)**

Mounting should be carried out by reference to the figure below.

1. Non-voltage input

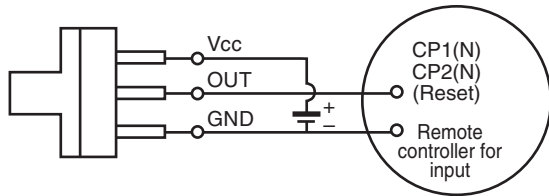

2. Transistor input (voltage input)

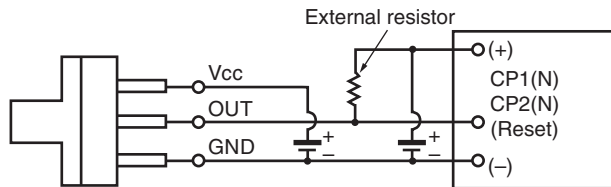

\* For details on external resistance calculation, see the text.

**Others**

1. Do not connect or disconnect the connector while power is applied. Doing so may result in breakage.
2. Do not mount the sensor in the following places because doing so may cause malfunction or damage.
  - 1) Places exposed to dust or oil mist
  - 2) Places exposed to corrosive gas
  - 3) Places directly or indirectly exposed to water, oil, or chemicals
  - 4) Outdoor or places exposed to intensive light, such as direct sunlight
  - 5) Make sure that the operating ambient temperature is within the rated range.
3. The sensor may be dissolved by exposure to organic solvents, acid, alkali, aromatic hydrocarbon, and chlorinated aliphatic hydrocarbon solvents, causing deterioration in the characteristics. Do not expose the sensor to such chemicals.
4. An output pulse may occur when the power supply is turned ON depending on the power supply and other conditions. Use the sensor in the stable ready-for-detection state reached in 100 ms after turning on the power supply.

Dimensions and Internal Circuit

Photomicrosensor

- EE-SX3173-P3-Z
- EE-SX4173-P3-Z
- EE-SX3173-P2
- EE-SX4173-P2



Aperture size (H x W)

Emitter	Detector
1.4 x 1.4	1.4 x 0.5

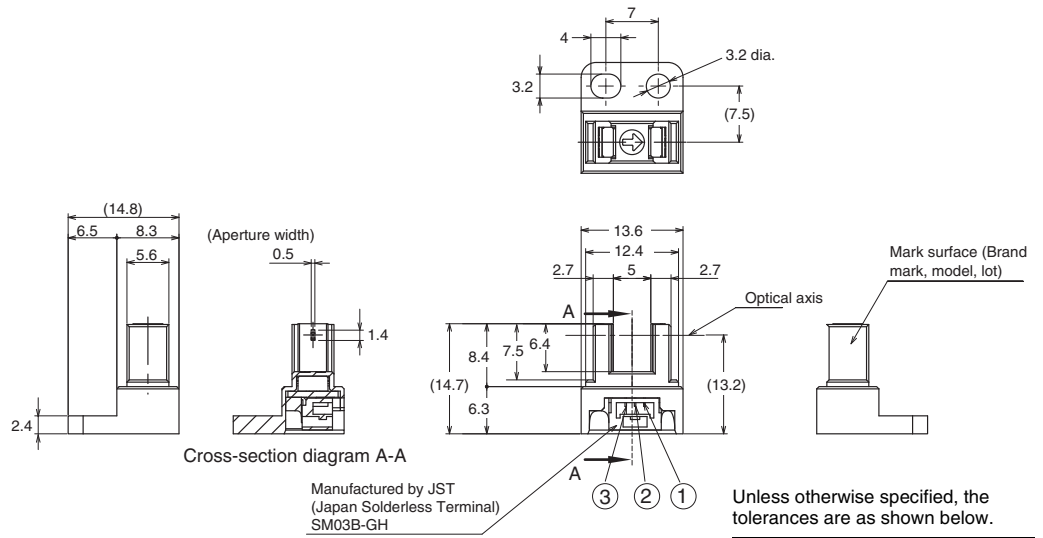

Unless otherwise specified, the tolerances are as shown below.

Internal circuit

- EE-SX3173-P3-Z
- EE-SX4173-P3-Z

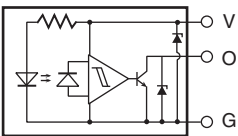

- EE-SX3173-P2
- EE-SX4173-P2

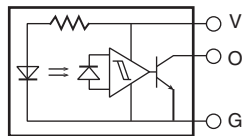

Terminal No.	Name
(1)	Ground GND
(2)	Output OUT
(3)	Power supply Vcc

Dimensions (mm)		Tolerance chart
Above	Below	
---	3	±0.2
3	6	±0.24
6	10	±0.29
10	18	±0.35
18	30	±0.42

Note: Dimensions in parentheses are for reference only.

Connector with Cable (Order Separately)

EE-5002 1M

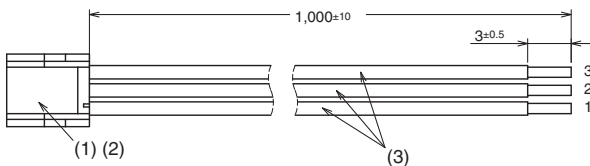

No.	Product	Model/Specification	Quantity	Manufacturer
(1)	Connector, HS for 101-150 harness	GHR-03V-S	1	JST
(2)	Connector, CT for 101-150 harness	SSHL-002TP0.2	3	JST
(3)	Lead wire	UL1061 AWG26	3	---

Wiring

Connector circuit Number	Lead wire color
1	Blue
2	Black
3	Brown



# Terms and Conditions Agreement

## Read and understand this catalog.

Please read and understand this catalog before purchasing the products. Please consult your OMRON representative if you have any questions or comments.

## Warranties.

- (a) Exclusive Warranty. Omron's exclusive warranty is that the Products will be free from defects in materials and workmanship for a period of twelve months from the date of sale by Omron (or such other period expressed in writing by Omron). Omron disclaims all other warranties, express or implied.
- (b) Limitations. OMRON MAKES NO WARRANTY OR REPRESENTATION, EXPRESS OR IMPLIED, ABOUT NON-INFRINGEMENT, MERCHANTABILITY OR FITNESS FOR A PARTICULAR PURPOSE OF THE PRODUCTS. BUYER ACKNOWLEDGES THAT IT ALONE HAS DETERMINED THAT THE PRODUCTS WILL SUITABLY MEET THE REQUIREMENTS OF THEIR INTENDED USE.

Omron further disclaims all warranties and responsibility of any type for claims or expenses based on infringement by the Products or otherwise of any intellectual property right. (c) Buyer Remedy. Omron's sole obligation hereunder shall be, at Omron's election, to (i) replace (in the form originally shipped with Buyer responsible for labor charges for removal or replacement thereof) the non-complying Product, (ii) repair the non-complying Product, or (iii) repay or credit Buyer an amount equal to the purchase price of the non-complying Product; provided that in no event shall Omron be responsible for warranty, repair, indemnity or any other claims or expenses regarding the Products unless Omron's analysis confirms that the Products were properly handled, stored, installed and maintained and not subject to contamination, abuse, misuse or inappropriate modification. Return of any Products by Buyer must be approved in writing by Omron before shipment. Omron Companies shall not be liable for the suitability or unsuitability or the results from the use of Products in combination with any electrical or electronic components, circuits, system assemblies or any other materials or substances or environments. Any advice, recommendations or information given orally or in writing, are not to be construed as an amendment or addition to the above warranty.

See <http://www.omron.com/global/> or contact your Omron representative for published information.

## Limitation on Liability; Etc.

OMRON COMPANIES SHALL NOT BE LIABLE FOR SPECIAL, INDIRECT, INCIDENTAL, OR CONSEQUENTIAL DAMAGES, LOSS OF PROFITS OR PRODUCTION OR COMMERCIAL LOSS IN ANY WAY CONNECTED WITH THE PRODUCTS, WHETHER SUCH CLAIM IS BASED IN CONTRACT, WARRANTY, NEGLIGENCE OR STRICT LIABILITY.

Further, in no event shall liability of Omron Companies exceed the individual price of the Product on which liability is asserted.

## Suitability of Use.

Omron Companies shall not be responsible for conformity with any standards, codes or regulations which apply to the combination of the Product in the Buyer's application or use of the Product. At Buyer's request, Omron will provide applicable third party certification documents identifying ratings and limitations of use which apply to the Product. This information by itself is not sufficient for a complete determination of the suitability of the Product in combination with the end product, machine, system, or other application or use. Buyer shall be solely responsible for determining appropriateness of the particular Product with respect to Buyer's application, product or system. Buyer shall take application responsibility in all cases.

NEVER USE THE PRODUCT FOR AN APPLICATION INVOLVING SERIOUS RISK TO LIFE OR PROPERTY OR IN LARGE QUANTITIES WITHOUT ENSURING THAT THE SYSTEM AS A WHOLE HAS BEEN DESIGNED TO ADDRESS THE RISKS, AND THAT THE OMRON PRODUCT(S) IS PROPERLY RATED AND INSTALLED FOR THE INTENDED USE WITHIN THE OVERALL EQUIPMENT OR SYSTEM.

## Programmable Products.

Omron Companies shall not be responsible for the user's programming of a programmable Product, or any consequence thereof.

## Performance Data.

Data presented in Omron Company websites, catalogs and other materials is provided as a guide for the user in determining suitability and does not constitute a warranty. It may represent the result of Omron's test conditions, and the user must correlate it to actual application requirements. Actual performance is subject to the Omron's Warranty and Limitations of Liability.

## Change in Specifications.

Product specifications and accessories may be changed at any time based on improvements and other reasons. It is our practice to change part numbers when published ratings or features are changed, or when significant construction changes are made. However, some specifications of the Product may be changed without any notice. When in doubt, special part numbers may be assigned to fix or establish key specifications for your application. Please consult with your Omron's representative at any time to confirm actual specifications of purchased Product.

## Errors and Omissions.

Information presented by Omron Companies has been checked and is believed to be accurate; however, no responsibility is assumed for clerical, typographical or proofreading errors or omissions.



Please check each region's Terms & Conditions by region website.

---

## **OMRON Corporation**

**Electronic and Mechanical Components Company**

### **Regional Contact**

#### **Americas**

<https://www.components.omron.com/>

#### **Asia-Pacific**

<https://ecb.omron.com.sg/>

#### **Korea**

<https://www.omron-ecb.co.kr/>

#### **Europe**

<http://components.omron.eu/>

#### **China**

<https://www.ecb.omron.com.cn/>

#### **Japan**

<https://www.omron.co.jp/ecb/>

# Mouser Electronics

Authorized Distributor

Click to View Pricing, Inventory, Delivery & Lifecycle Information:

Omron:

[EE-SX3173-P2](#) [EE-SX3173-P3-Z](#) [EE-SX4173-P3-Z](#) [EE-SX4173-P2](#)



Компания «ЭлектроПласт» предлагает заключение долгосрочных отношений при поставках импортных электронных компонентов на взаимовыгодных условиях!

Наши преимущества:

- Оперативные поставки широкого спектра электронных компонентов отечественного и импортного производства напрямую от производителей и с крупнейших мировых складов;
- Поставка более 17-ти миллионов наименований электронных компонентов;
- Поставка сложных, дефицитных, либо снятых с производства позиций;
- Оперативные сроки поставки под заказ (от 5 рабочих дней);
- Экспресс доставка в любую точку России;
- Техническая поддержка проекта, помощь в подборе аналогов, поставка прототипов;
- Система менеджмента качества сертифицирована по Международному стандарту ISO 9001;
- Лицензия ФСБ на осуществление работ с использованием сведений, составляющих государственную тайну;
- Поставка специализированных компонентов (Xilinx, Altera, Analog Devices, Intersil, Interpoint, Microsemi, Aeroflex, Peregrine, Syfer, Eurofarad, Texas Instrument, Miteq, Cobham, E2V, MA-COM, Hittite, Mini-Circuits, General Dynamics и др.);

Помимо этого, одним из направлений компании «ЭлектроПласт» является направление «Источники питания». Мы предлагаем Вам помощь Конструкторского отдела:

- Подбор оптимального решения, техническое обоснование при выборе компонента;
- Подбор аналогов;
- Консультации по применению компонента;
- Поставка образцов и прототипов;
- Техническая поддержка проекта;
- Защита от снятия компонента с производства.



#### Как с нами связаться

**Телефон:** 8 (812) 309 58 32 (многоканальный)

**Факс:** 8 (812) 320-02-42

**Электронная почта:** [org@eplast1.ru](mailto:org@eplast1.ru)

**Адрес:** 198099, г. Санкт-Петербург, ул. Калинина, дом 2, корпус 4, литера А.