

Technical Data Sheet Opto Interrupter EAITRCB0

Features

- Fast response time
- High analytic
- High sensitivity
- Cut-off visible wavelength $\lambda_P=940\text{nm}$
- Pb Free
- This product itself will remain within RoHS compliant version.

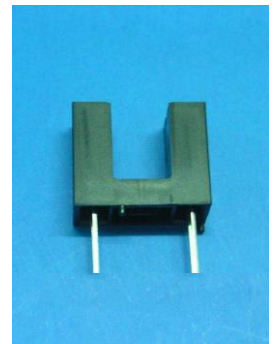

Description

The **EAITRCB0** consist of an infrared emitting diode and an NPN silicon phototransistor, encased side-by-side on converging optical axis in a black thermoplastic housing . The phototransistor receives radiation from the IR LED only .This is the normal situation. But when an object is between the IR and PT, phototransistor could not receive the radiation. For additional component information, please refer to IR908-7C-F and PT908-7C-F

Applications

- Mouse Copier
- Switch Scanner
- Floppy disk driver
- Non-contact Switching
- For Direct Board

Device Selection Guide

Device No.	Chip Material	LENS COLOR
IR	GaAlAs	Water clear
PT	Silicon	Water clear

Absolute Maximum Ratings (Ta=25°C)

Parameter		Symbol	Ratings	Unit
Input	Power Dissipation at(or below) 25°C Free Air Temperature	Pd	75	mW
	Reverse Voltage	V _R	5	V
	Forward Current	I _F	50	mA
	Peak Forward Current (*1) Pulse width ≤100μs, Duty cycle=1%	I _{FP}	1	A
Output	Collector Power Dissipation	P _C	75	mW
	Collector Current	I _C	20	mA
	Collector-Emitter Voltage	B V _{CEO}	30	V
	Emitter-Collector Voltage	B V _{ECO}	5	V
Operating Temperature		T _{opr}	-25~+85	°C
Storage Temperature		T _{stg}	-40~+100	°C
Lead Soldering Temperature (*2) (1/16 inch form body for 5 seconds)		T _{sol}	260	°C

Notes: (*1) $t_w=100 \mu\text{sec.}$, $T=10 \text{ msec.}$ (*2) $t=5 \text{ Sec}$

Electro-Optical Characteristics (Ta=25°C)

Parameter		Symbol	Min.	Typ.	Max.	Unit	Condition
Input	Forward Voltage	V_F	-	1.2	1.5	V	$I_F=20mA$
	Reverse Current	I_R	-	-	10	μA	$V_R=5V$
	Peak Wavelength	λ_P	-	940	-	nm	$I_F=20mA$
Output	Dark Current	I_{CEO}	-	-	100	nA	$V_{CE}=20V, E_e=0mW/cm^2$
	C-E Saturation Voltage	$V_{CE(sat)}$	-	-	0.4	V	$I_C=2mA, E_e=1mW/cm$
Collector Current(*3)		$I_{C(ON)}$	0.9	-	-	mA	$V_{CE}=5V, I_F=20mA$
Response Time	Rise Time	t_R	-	15	-	μs	$V_{CE}=5V \quad I_C=1mA \quad R_L=1K\Omega$
	Fall Time	t_F	-	15	-	μs	

Typical Electrical/Optical/Characteristics Curves for IR

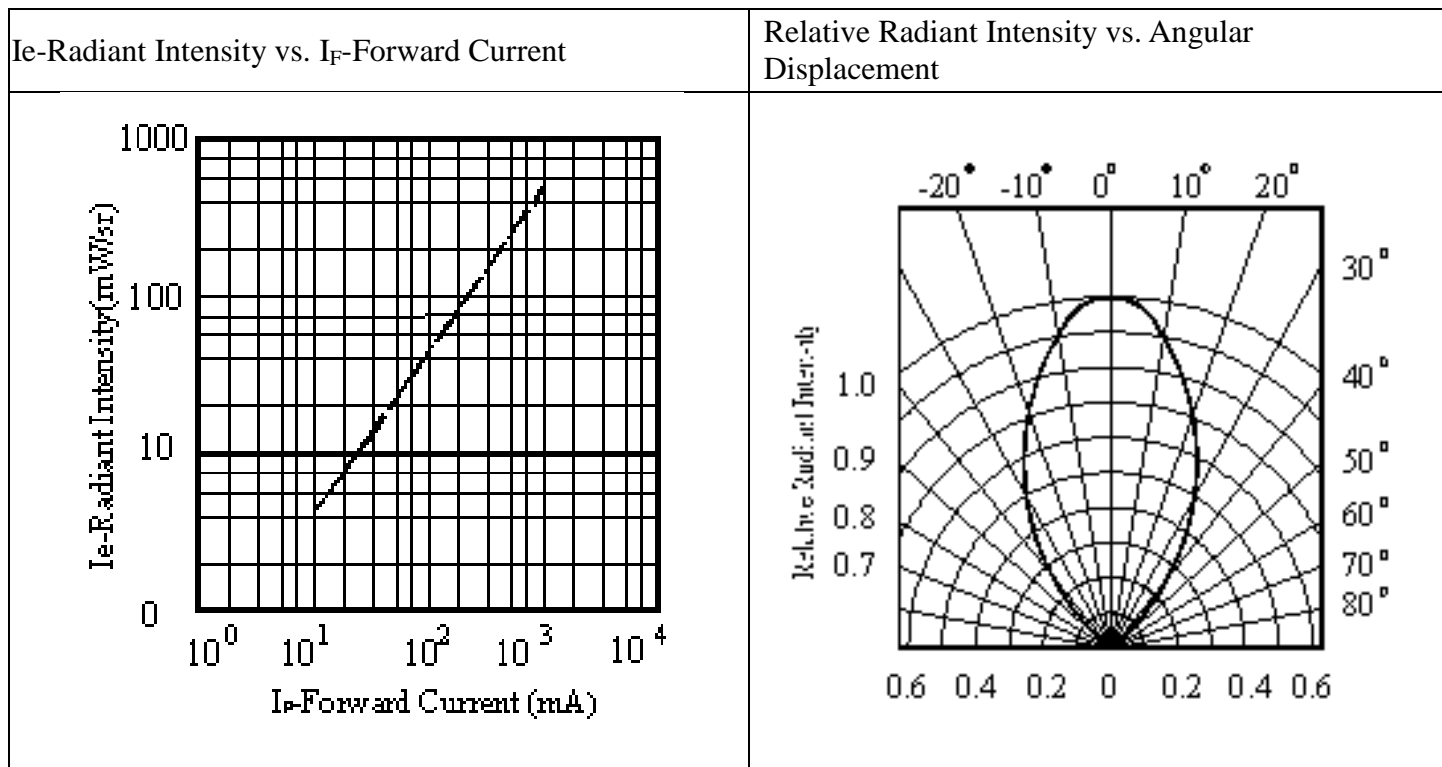
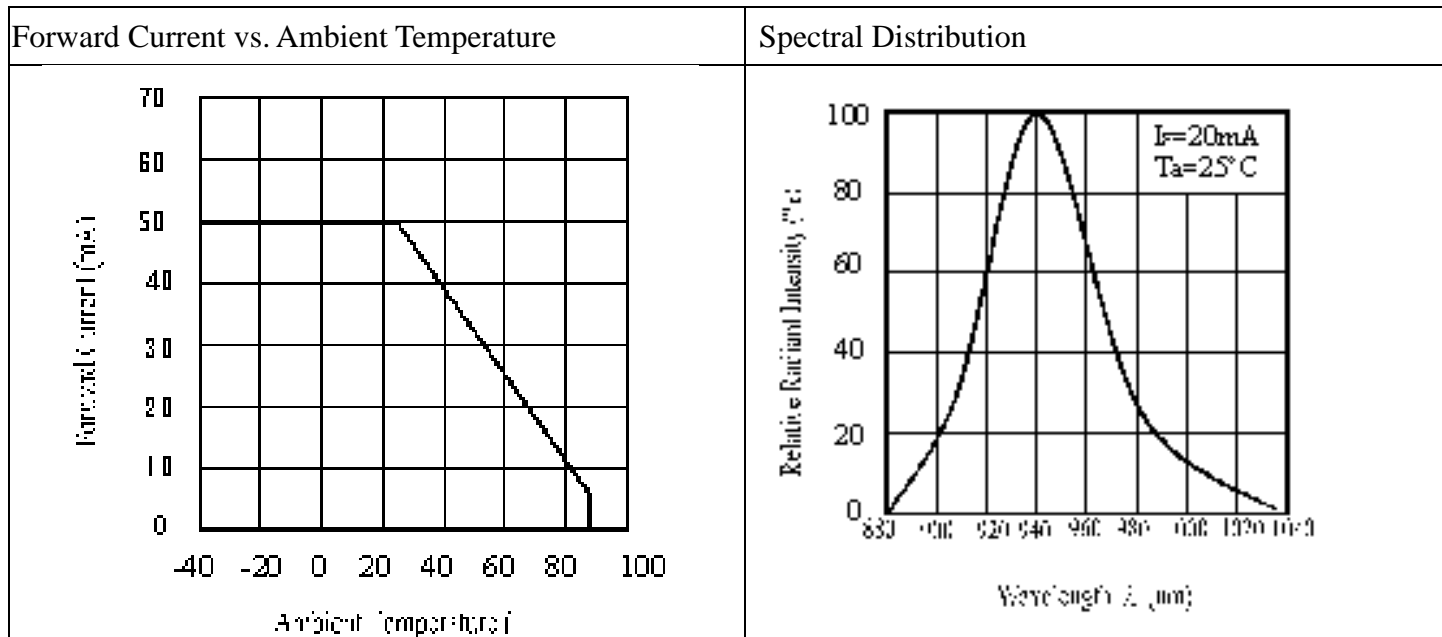

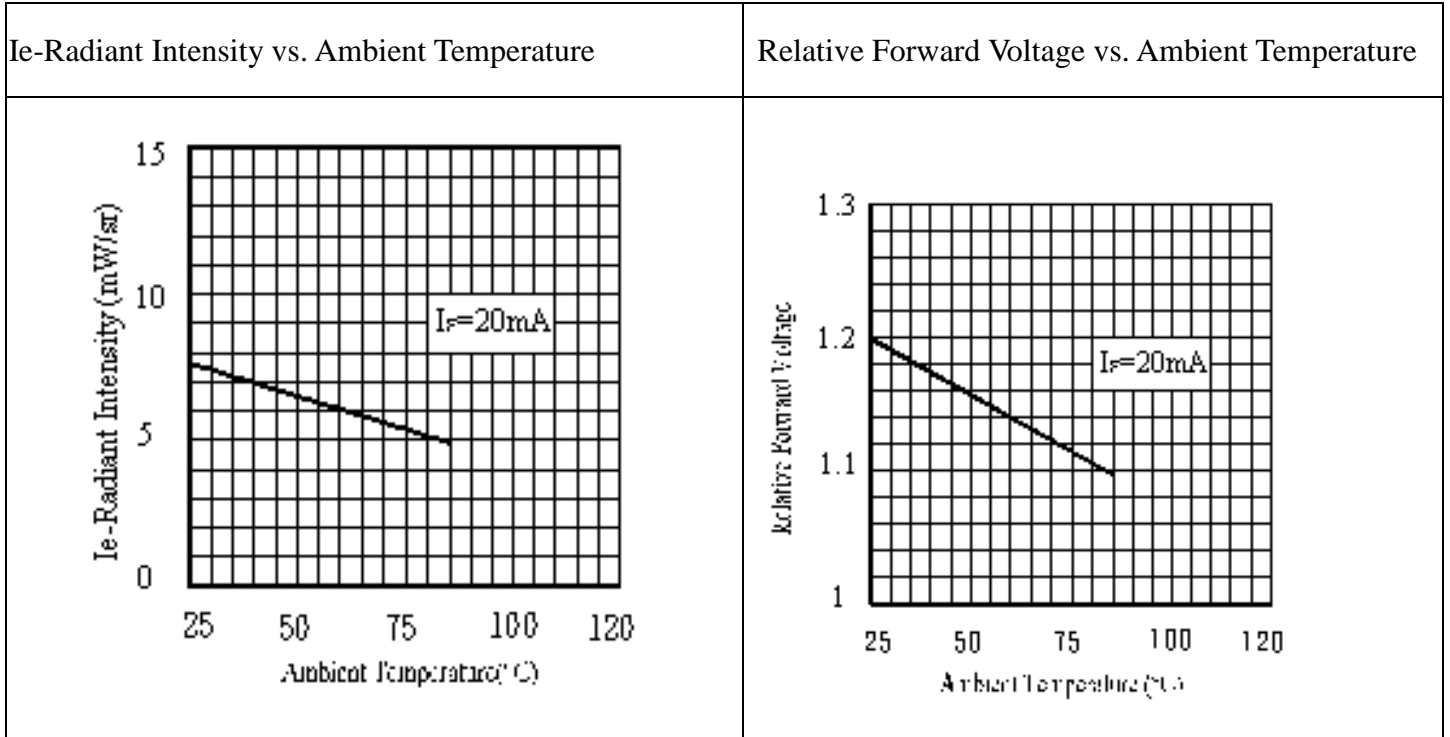

Typical Electro/Optical/Characteristics Curves for PT

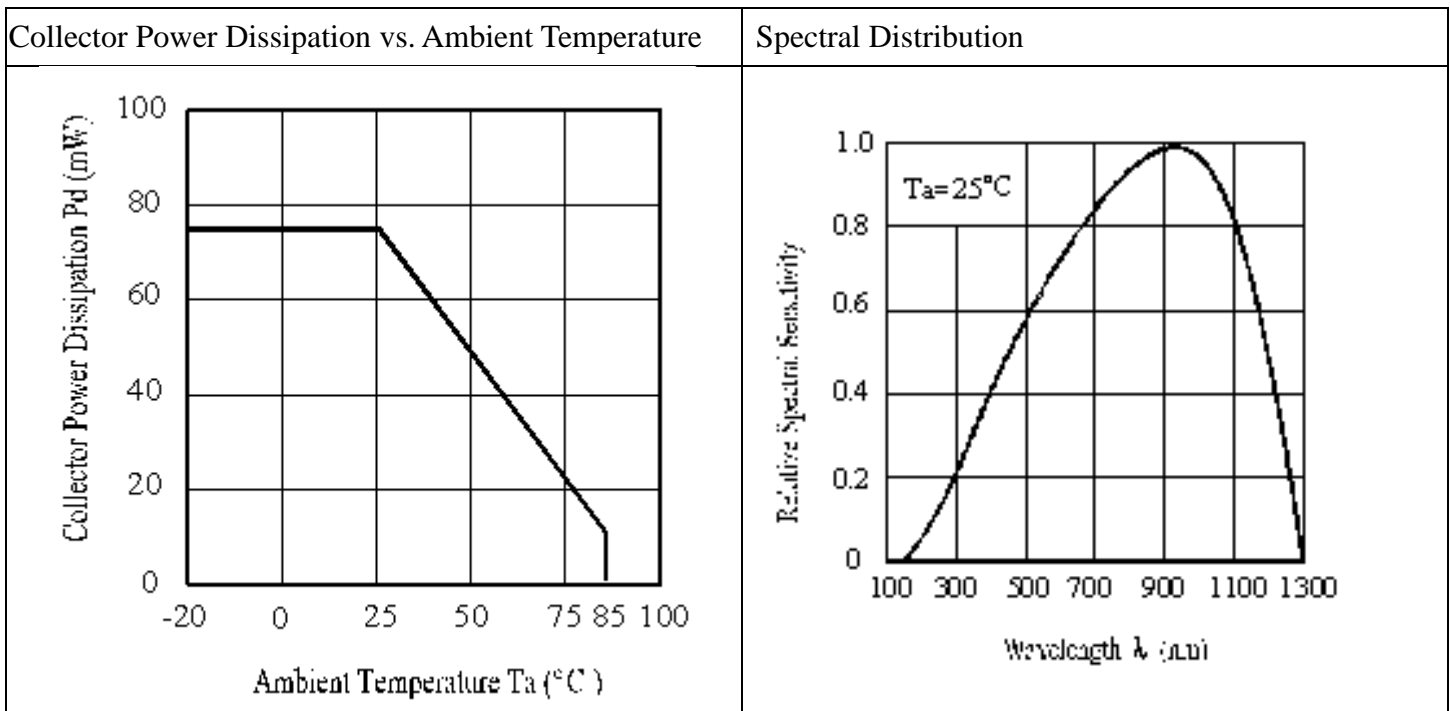

Relative Collector Current vs. Ambient Temperature

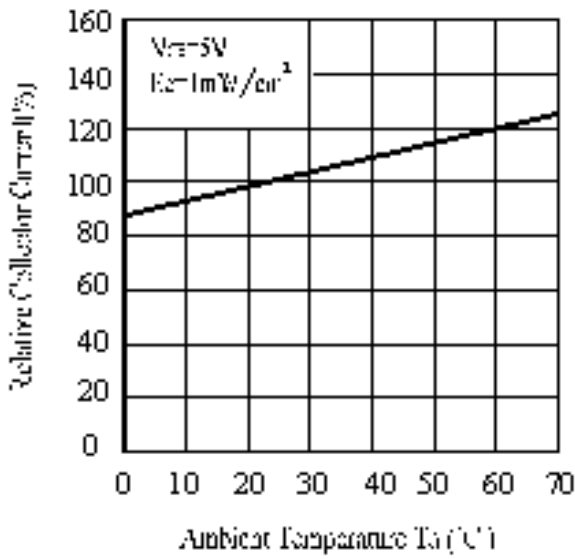

Collector Current vs. Irradiance

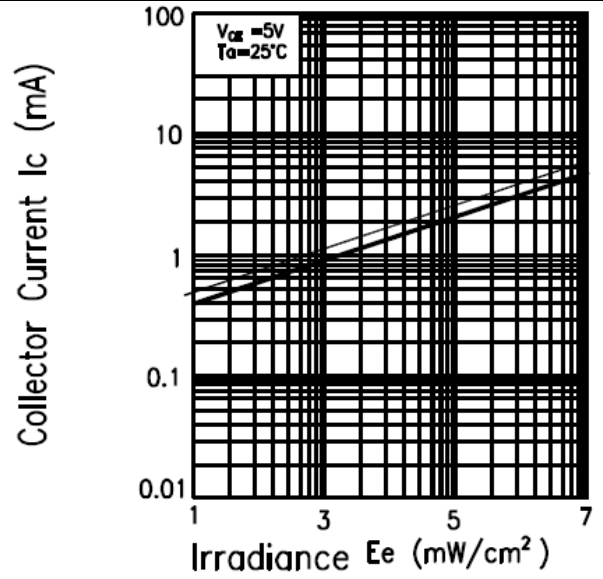

Collector Dark Current vs. Ambient Temperature

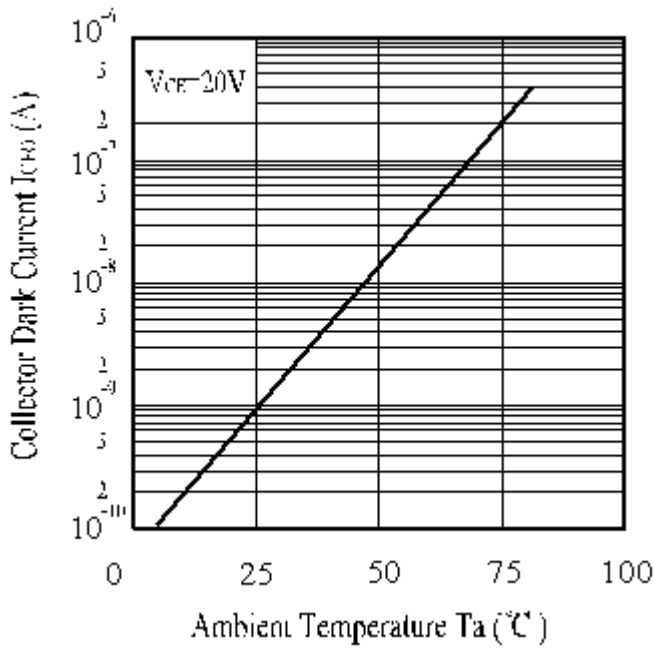

Collector Current vs. Collector-Emitter Voltage

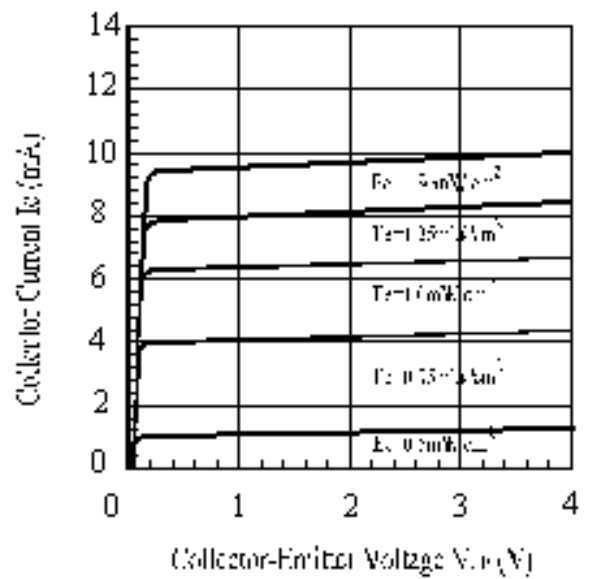

Reliability Test Item And Condition

The reliability of products shall be satisfied with items listed below.

Confidence level : 90%

LTPD : 10%

NO.	Item	Test Condition	Test Hours/ Cycle	Sample Size	Failure Judgement Criteria	Ac/Re
1	Solder Heat	TEMP : 260°C ± 5 °C	10 sec	22 PCs	Ic(on) ≤ L×0.8 L :Lower specification limit	0/1
2	Temperature Cycle	H : +100°C 15 mins ↑ 5 min ↓ L : -40°C 15 min	300 cycle	22 PCs		0/1
3	Thermal Shock	H : +100°C 5 min ↑ 10 sec ↓ L : -10°C 5 min	300 cycle	22 PCs		0/1
4	High Temperature Storage	TEMP. : +100°C	1000 hrs	22 PCs		0/1
5	Low Temperature Storage	TEMP. : -40°C	1000 hrs	22 PCs		0/1
6	DC Operating Life	V _{CE} =5V I _F =20mA	1000 hrs	22 PCs		0/1
7	High Temperature / High Humidity	85°C / 85% R.H.	1000 hrs	22 PCs		0/1

Package Dimension

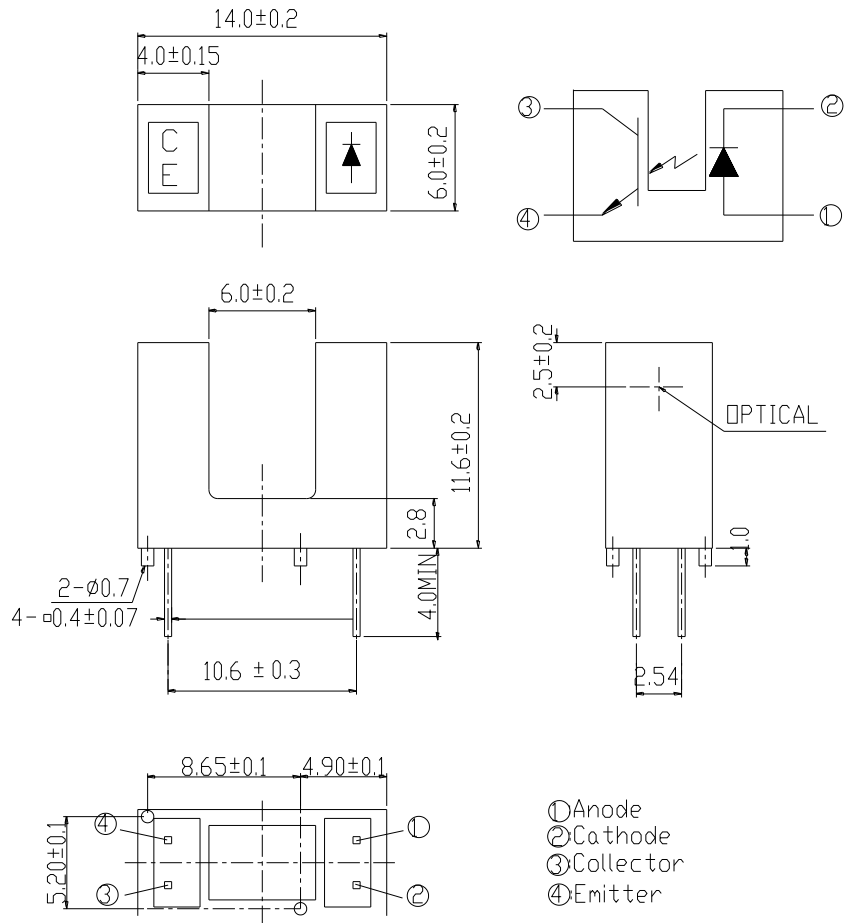

Notes:

1. All dimensions are in millimeters
2. Tolerances unless dimensions ± 0.2 mm

Packing Quantity Specification

1. 120PCS/1Plate,5Plate/1Boxe
2. 10Boxes/1Carton

Label Form Specification

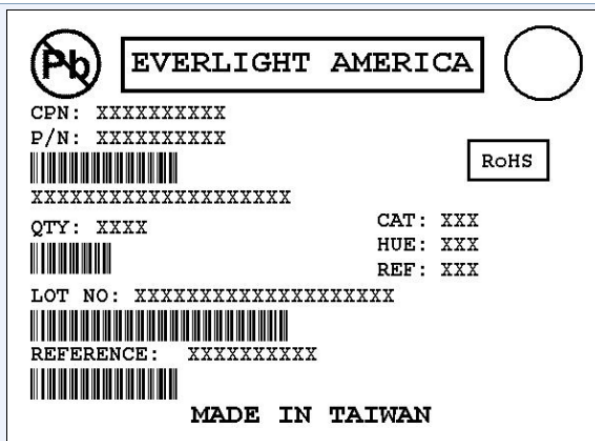

- CPN: Customer's Product Number
- P/N: Product Number
- QTY: Packing Quantity
- CAT: Luminous Intensity Rank
- HUE: Dom. Wavelength Rank
- REF: Forward Voltage Rank
- LOT No: Lot Number
- X: Month
- Reference: Identify Label Number

Notes

1. Above specification may be changed without notice. EVERLIGHT Americas will reserve authority on material change for above specification.
2. When using this product, please observe the absolute maximum ratings and the instructions for using outlined in these specification sheets. EVERLIGHT Americas assumes no responsibility for any damage resulting from use of the product which does not comply with the absolute maximum ratings and the instructions included in these specification sheets.
3. These specification sheets include materials protected under copyright of EVERLIGHT Americas corporation. Please don't reproduce or cause anyone to reproduce them without EVERLIGHT Americas consent.



Компания «ЭлектроПласт» предлагает заключение долгосрочных отношений при поставках импортных электронных компонентов на взаимовыгодных условиях!

Наши преимущества:

- Оперативные поставки широкого спектра электронных компонентов отечественного и импортного производства напрямую от производителей и с крупнейших мировых складов;
- Поставка более 17-ти миллионов наименований электронных компонентов;
- Поставка сложных, дефицитных, либо снятых с производства позиций;
- Оперативные сроки поставки под заказ (от 5 рабочих дней);
- Экспресс доставка в любую точку России;
- Техническая поддержка проекта, помощь в подборе аналогов, поставка прототипов;
- Система менеджмента качества сертифицирована по Международному стандарту ISO 9001;
- Лицензия ФСБ на осуществление работ с использованием сведений, составляющих государственную тайну;
- Поставка специализированных компонентов (Xilinx, Altera, Analog Devices, Intersil, Interpoint, Microsemi, Aeroflex, Peregrine, Syfer, Eurofarad, Texas Instrument, Miteq, Cobham, E2V, MA-COM, Hittite, Mini-Circuits, General Dynamics и др.);

Помимо этого, одним из направлений компании «ЭлектроПласт» является направление «Источники питания». Мы предлагаем Вам помощь Конструкторского отдела:

- Подбор оптимального решения, техническое обоснование при выборе компонента;
- Подбор аналогов;
- Консультации по применению компонента;
- Поставка образцов и прототипов;
- Техническая поддержка проекта;
- Защита от снятия компонента с производства.



Как с нами связаться

Телефон: 8 (812) 309 58 32 (многоканальный)

Факс: 8 (812) 320-02-42

Электронная почта: org@eplast1.ru

Адрес: 198099, г. Санкт-Петербург, ул. Калинина, дом 2, корпус 4, литера А.