

General Description

Qorvo's RFUV1703 is a 21 GHz to 26.5 GHz GaAs pHEMT upconverter, incorporating an integrated doubler, LO buffer amplifier, a balanced single sideband (image rejection) mixer followed by Variable Gain Amplifier, DC decoupling capacitors. The combination of high performance part and low-cost packaging makes the RFUV1703 a cost effective solution, ideally suited to both current and next generation point-to-point and V_{SAT} applications. RFUV1703 is packaged in a 5 mm x 5 mm QFN to simplify both system level board design and volume assembly.

Lead-free and RoHS compliant

Functional Block Diagram

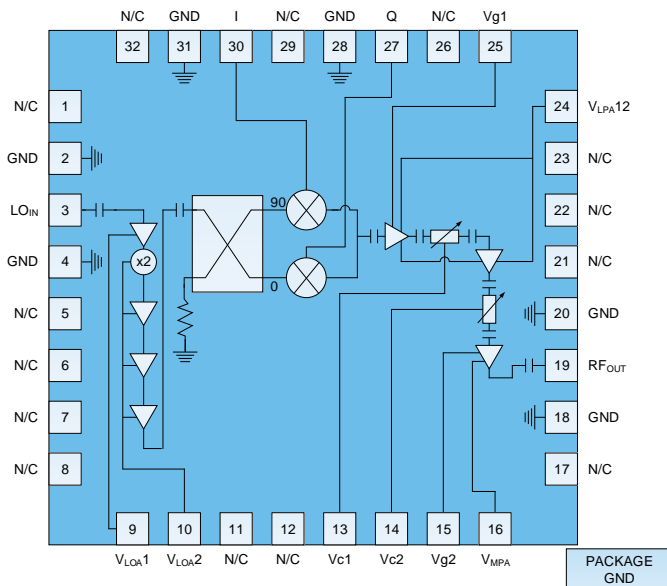

Package: QFN, 32 Pin, 5 mm x 5 mm x 0.95 mm

Product Features

- RF Frequency: 21 GHz to 26.5 GHz
- LO Frequency (LSB): 10.5 GHz to 15.2 GHz
- LO Frequency (USB): 8.5 GHz to 13.25 GHz
- IF Frequency: DC to 4 GHz
- Conversion Gain (Max): 21 dB
- Conversion Gain (Min): -10 dB
- NF (Max. Gain): 12 dB
- OIP3 (Max. Gain): +27 dBm
- Image Rejection: 15 dBc

Performance is typical across frequency. Please reference electrical specification table and data plots for more details.

Applications

- Point-to-Point
- V_{SAT}

Ordering Information

Part	Description
RFUV1703S2	2-Piece Sample Bag
RFUV1703SB	5-Piece Bag
RFUV1703SQ	25-Piece Bag
RFUV1703SR	100 Pieces on 7" reel
RFUV1703TR7	750 Pieces on 7" reel
RFUV1703PCBA-410	Evaluation Board

Absolute Maximum Ratings

Parameter	Rating	Unit
LPA Drain Voltage V_D	6	V
LOA Drain Voltage	6	V
IF Input Power	15	dBm
LO Input Power	15	dBm
Storage Temperature	-65 to +150	°C

Exceeding any one or a combination of the Absolute Maximum Rating conditions may cause permanent damage to the device. Extended application of Absolute Maximum Rating conditions to the device may reduce device reliability.

Nominal Operating Parameters

Parameter	Specification			Units	Condition
	Min	Typical	Max		
RF Frequency	21		26.5	GHz	
LO Frequency: LSB	10.5		15.25	GHz	
LO Frequency: USB	8.5		13.25	GHz	
IF Frequency	DC	2.5	4.0	GHz	
LO input Drive		0		dBm	
Conversion Gain (Max.) (USB)	19	21		dB	LO = 9.95 GHz & 11.5 GHz
Conversion Gain (Min.) (USB)	-5.5	-5		dB	LO = 9.95 GHz & 11.5 GHz
OIP3 (Max. Gain) (USB)	23.5	29		dBm	LO = 9.95 GHz
OIP3 (-5 dB Gain) (USB)	0.5	6.5		dBm	LO = 9.95 GHz
OIP3 (Max. Gain) (USB)	20.5	27		dBm	LO = 11.5 GHz
OIP3 (-5 dB Gain) (USB)	4	9		dBm	LO = 11.5 GHz
Image Rejection (Max. Gain) (USB)	15	20		dBc	LO = 9.95 GHz
Image Rejection (Max. Gain) (USB)	14	20		dBc	LO = 11.5 GHz
LO Leakage @ RF-Port (Max. Gain) (USB)		-10	5	dBm	LO = 9.95 GHz
LO Leakage @ RF-Port (Max. Gain) (USB)		1	7.5	dBm	LO = 11.5 GHz
NF (Max. Gain)		12		dB	
LO Return Loss		10		dB	
RF Return Loss		10		dB	
V_{LOA}		4		V	
V_{LPA}		3.5		V	
V_{MOA}		4.5		V	
I_{LOA}		205		mA	
$I_{LOA1,2}$		120		mA	
I_{MPA}		120		mA	
I_{TOTAL}		445		mA	
V_{C1}, V_{C2}	-4		0	V	
Operating Temperature	-55	25	85	°C	

Performance Plots – USB Conversion

Measurements performed with I and Q (IF) ports connected to an external 90° Hybrid

Test conditions unless otherwise noted: LO Power = 0 dBm and IF = 2.5 GHz, -10 dBm

$V_{LOA1} = V_{LOA2} = 4\text{ V}$, $I_{LOA1,2} = 205\text{ mA}$; $V_{LPA12} = 3.5\text{ V}$, Adjust V_{G1} around -0.4 V to get $I_{LPA12} = 120\text{ mA}$

$V_{MPA} = 4.5\text{ V}$, Adjust V_{G2} to get $I_{MPA} = 120\text{ mA}$, $I_{TOTAL} = 445\text{ mA}$, $V_{C1} = V_{C2} = -4\text{ V}$

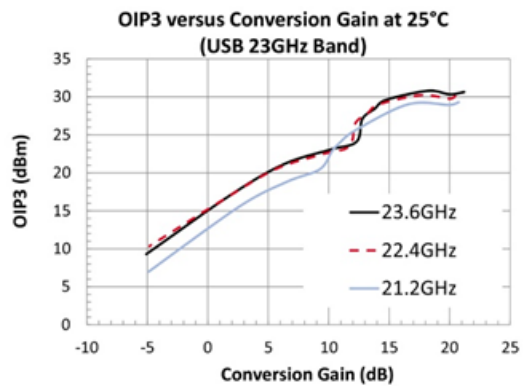
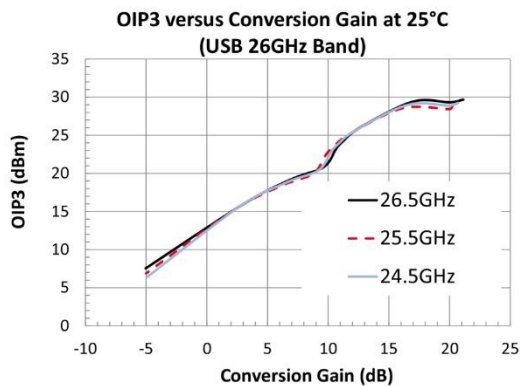
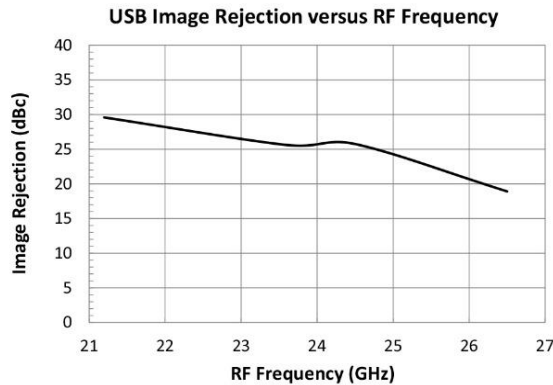
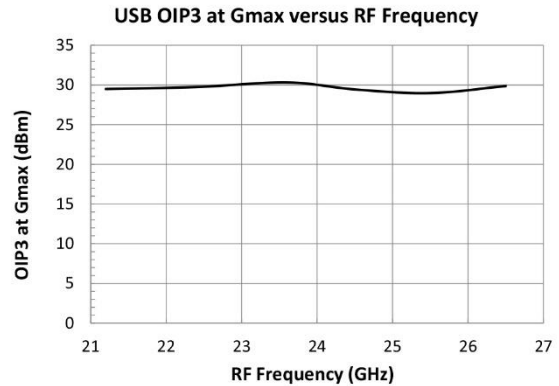
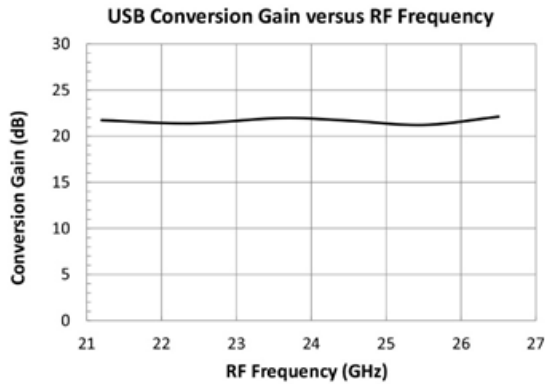

Performance Plots – USB LO Leakage & Over Temperature

Measurements performed with I and Q (IF) ports connected to an external 90° Hybrid

Test conditions unless otherwise noted: LO Power = 0 dBm and IF = 2.5 GHz, -10 dBm

$V_{LOA1} = V_{LOA2} = 4\text{ V}$, $I_{LOA1,2} = 205\text{ mA}$; $V_{LPA12} = 3.5\text{ V}$, Adjust V_{G1} around -0.4 V to get $I_{LPA12} = 120\text{ mA}$

$V_{MPA} = 4.5\text{ V}$, Adjust V_{G2} to get $I_{MPA} = 120\text{ mA}$, $I_{TOTAL} = 445\text{ mA}$, $V_{C1} = V_{C2} = -4\text{ V}$

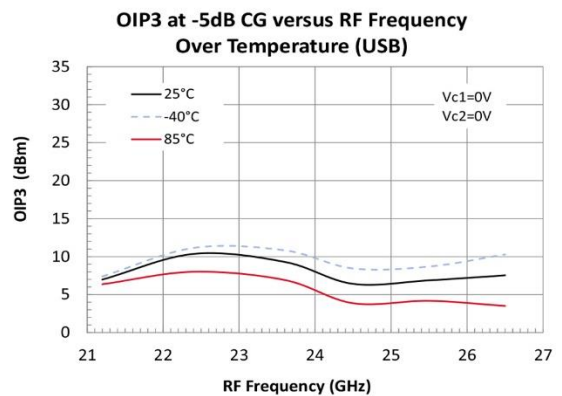
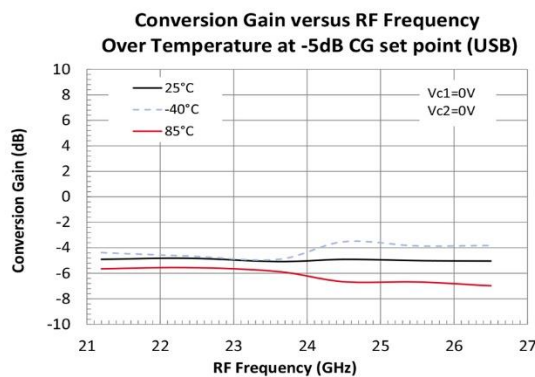
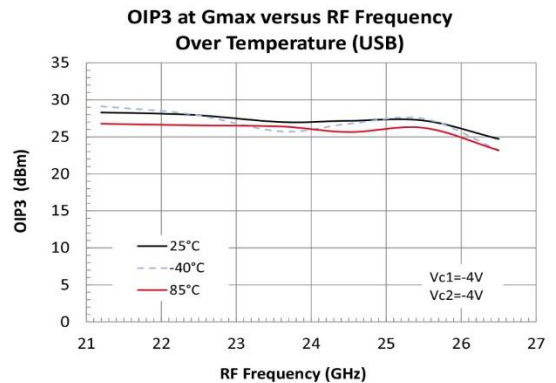
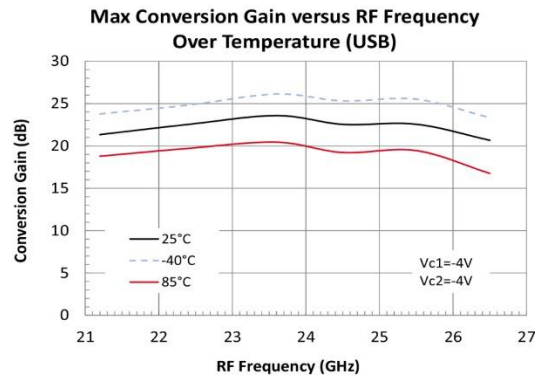
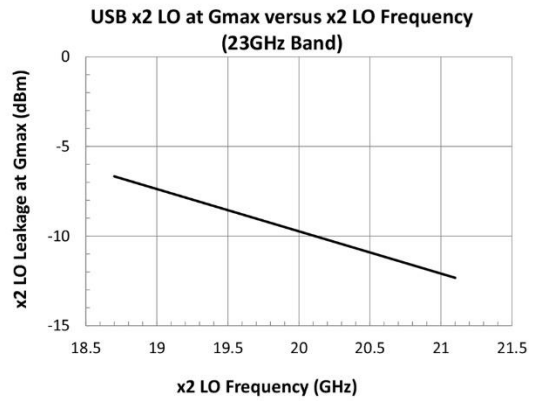
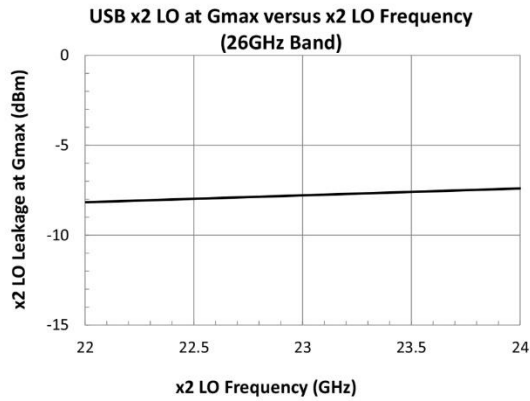

Performance Plots – LSB Conversion & LO Leakage

Measurements performed with I and Q (IF) ports connected to an external 90° Hybrid

Test conditions unless otherwise noted: LO Power = 0 dBm and IF = 2.5 GHz, -10 dBm

$V_{LOA1} = V_{LOA2} = 4\text{ V}$, $I_{LOA1,2} = 205\text{ mA}$; $V_{LPA12} = 3.5\text{ V}$, Adjust V_{G1} around -0.4 V to get $I_{LPA12} = 120\text{ mA}$

$V_{MPA} = 4.5\text{ V}$, Adjust V_{G2} to get $I_{MPA} = 120\text{ mA}$, $I_{TOTAL} = 445\text{ mA}$, $V_{C1} = V_{C2} = -4\text{ V}$

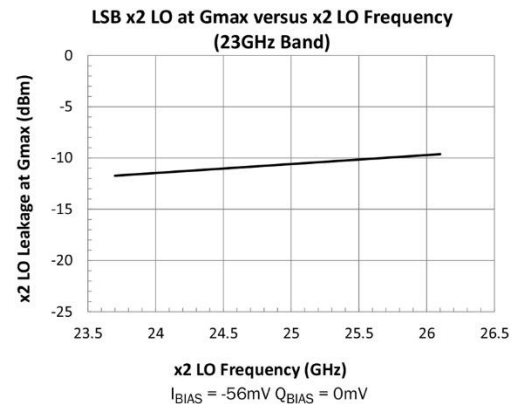
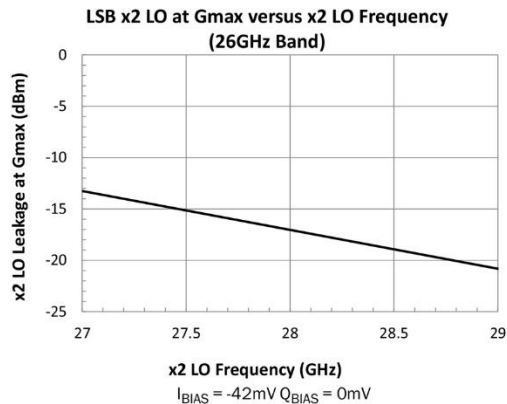
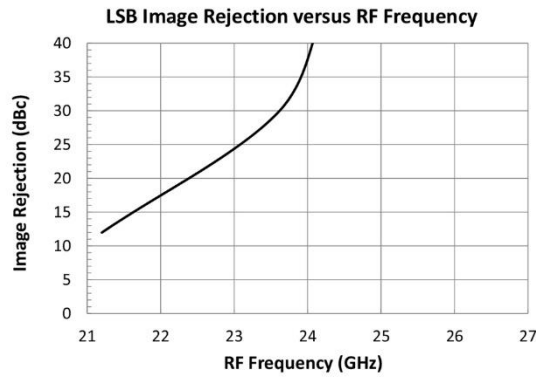
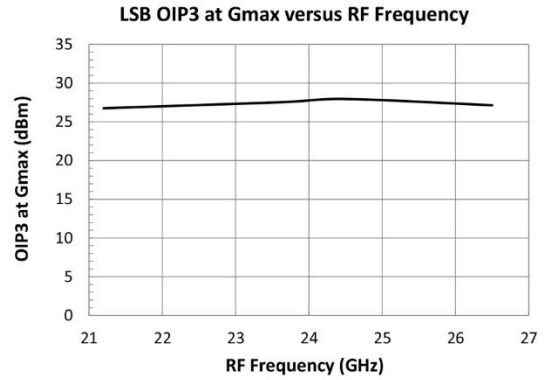
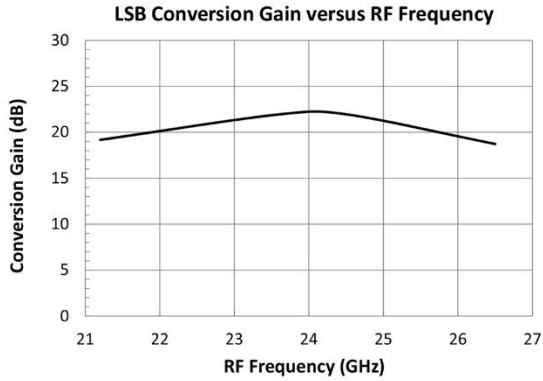

Performance Plots – USB: Without IQ Bias

Measurements performed with I and Q (IF) ports connected to an external 90° Hybrid

Test conditions unless otherwise noted: LO Power = 0 dBm and IF = 2.5 GHz, -10 dBm

$V_{MPA} = 4.5\text{ V}$, $V_{LPA12} = 3.5\text{ V}$, $V_{LOA1} = V_{LOA2} = 4\text{ V}$, $I_{TOTAL} = 445\text{ mA}$, $V_{G1} = V_{G2} = -0.4\text{ V}$

V_{C1} and V_{C2} are connected together off chip and changes over (-4 V to 0 V): **Single Control Bias**

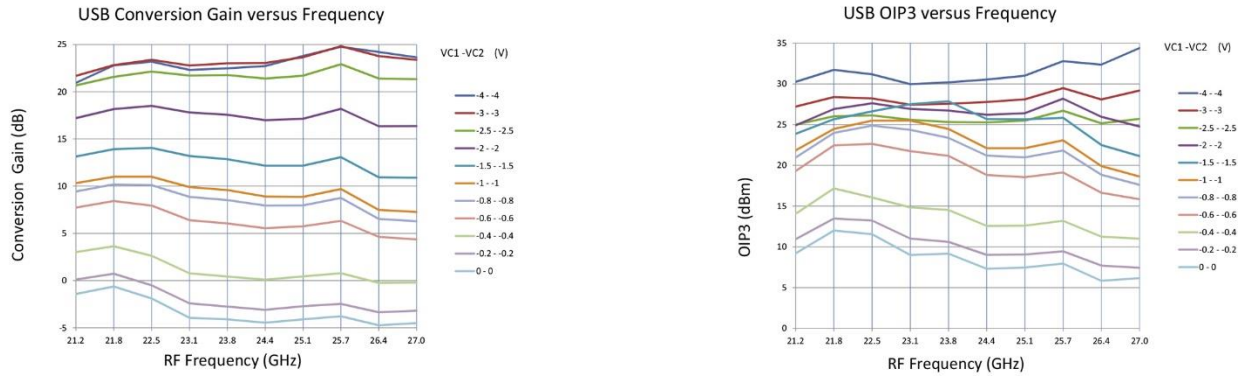

$V_{MPA} = 4.5\text{ V}$, $V_{LPA12} = 3.5\text{ V}$, $V_{LOA1} = V_{LOA2} = 4\text{ V}$, $I_{TOTAL} = 445\text{ mA}$, $V_{G1} = V_{G2} = -0.4\text{ V}$

V_{C1} and V_{C2} are separated controlled and changes over (-4 V to 0 V): **Double Control Bias**

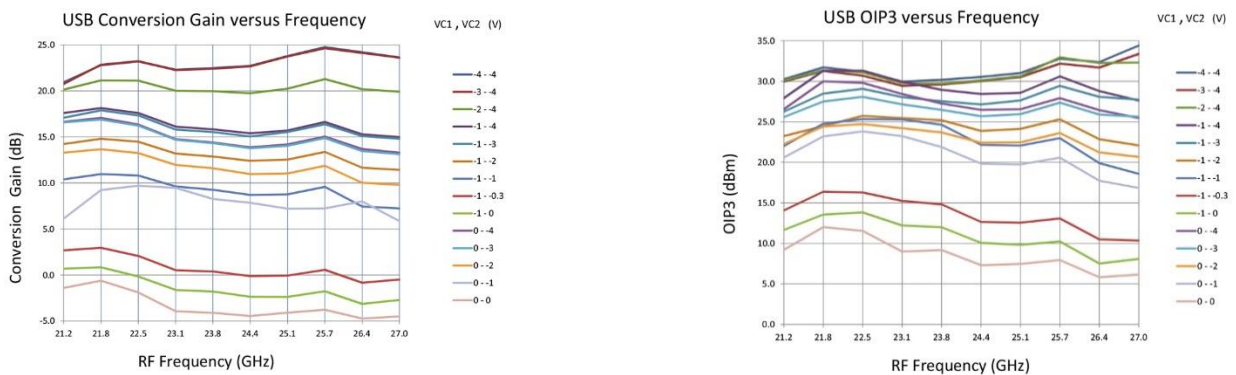

Performance Plots – USB: Without IQ Bias (continued)

Measurements performed with I and Q (IF) ports connected to an external 90° Hybrid

Test conditions unless otherwise noted: LO Power = 0 dBm and IF = 2.5 GHz, -10 dBm

$V_{MPA} = 4.5\text{ V}$, $V_{LPA12} = 3.5\text{ V}$, $V_{LOA1} = V_{LOA2} = 4\text{ V}$, $V_{C1} = V_{C2} = -4\text{ V}$

V_{G1} and V_{G2} are connected together off chip and changes over (-0.3 V to -1 V): **Single Control on $V_{G1} = V_{G2}$**

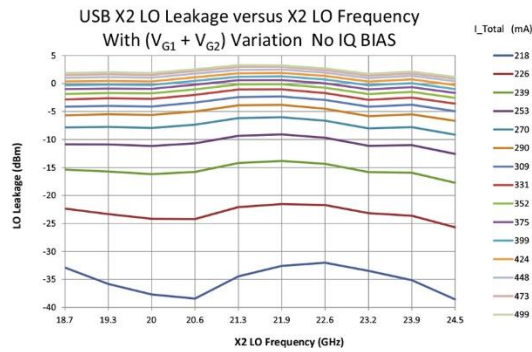
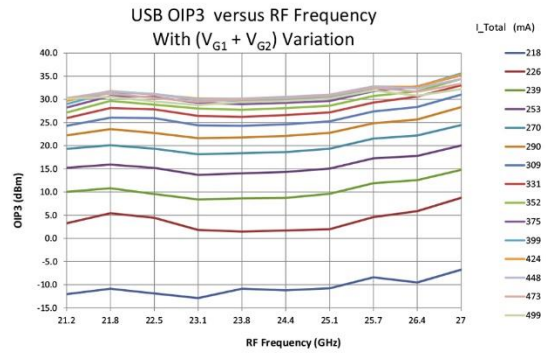
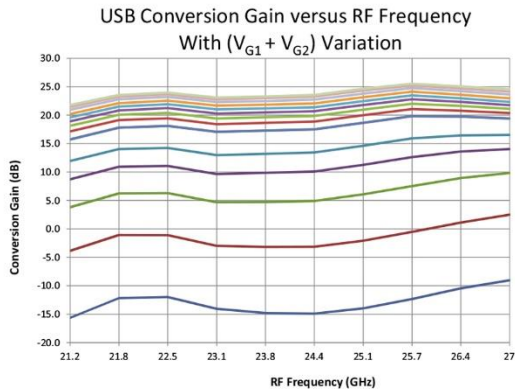

Application Circuit Block Diagram

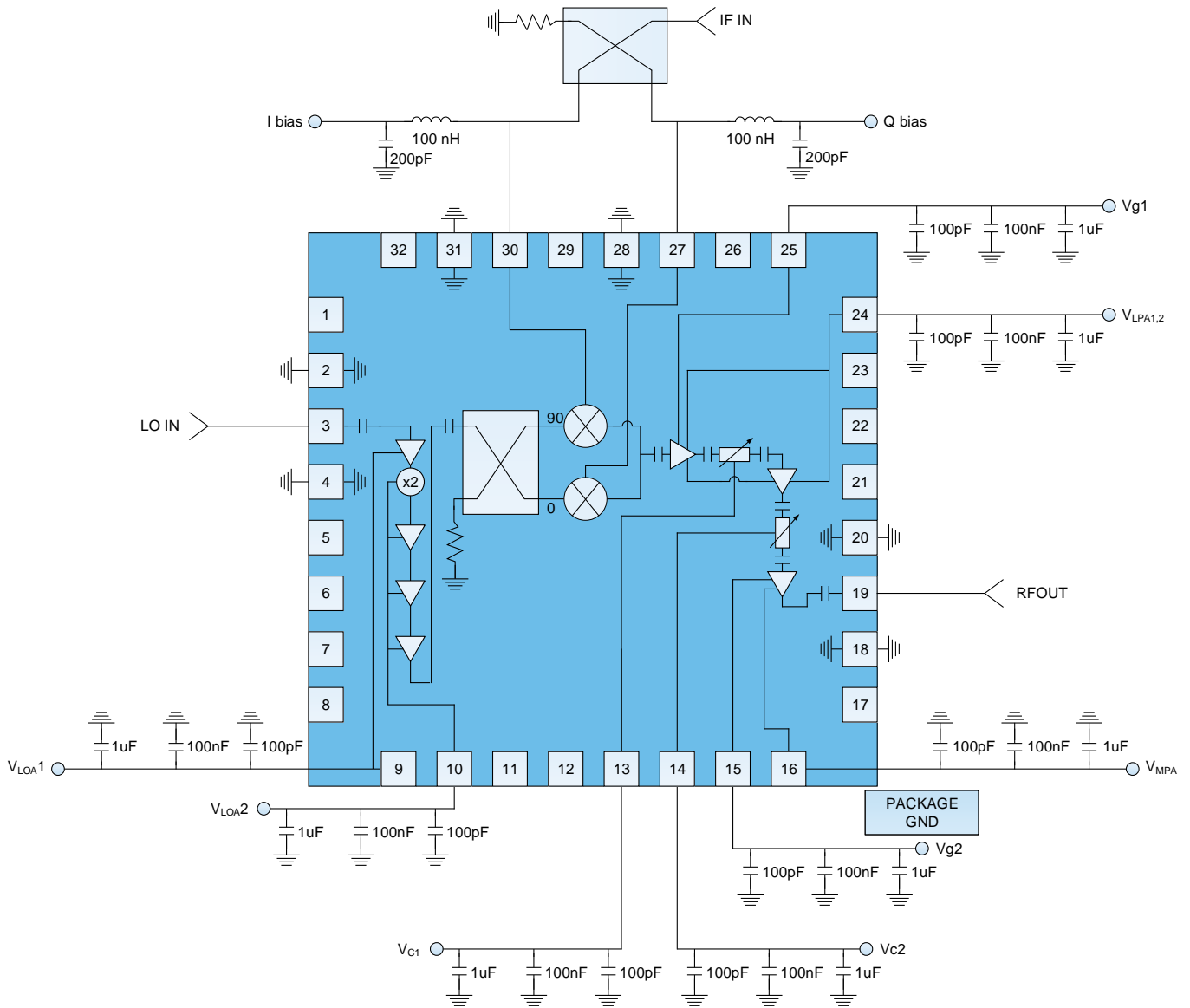

$2 * LO - IF = RF$ (LSB), LO = 10.5 to 15.25 GHz

$2 * LO + IF = RF$ (USB), LO = 8.5 GHz to 13.25 GHz

Notes:

1. External components for IQ biases are required.
2. External hybrid coupler is required.

Evaluation Board Layout

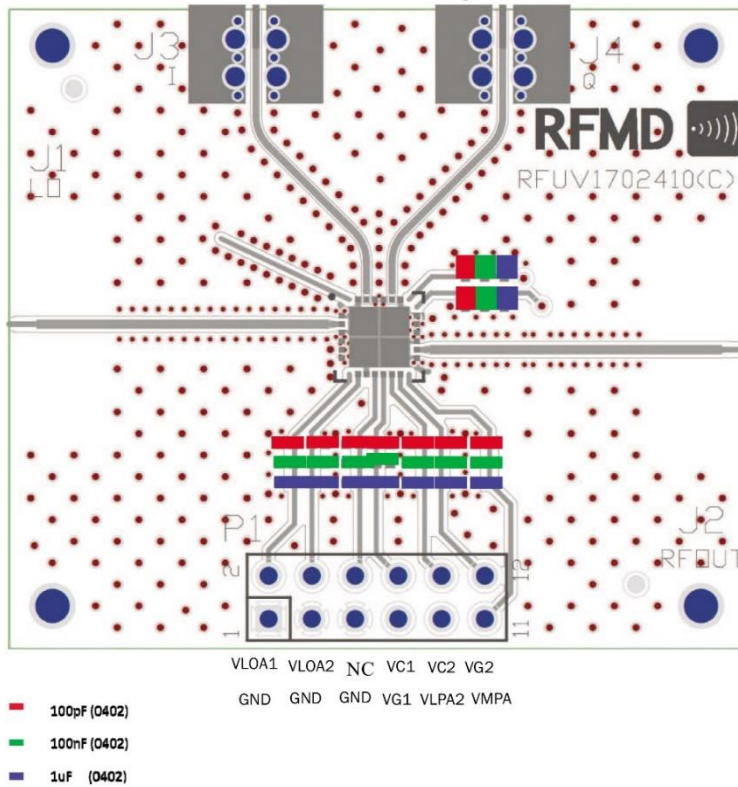

Sub-Band Frequency Ranges

Band	Frequency Range
23 GHz	21.2 GHz to 23.6 GHz
26 GHz	24.5 GHz to 26.5 GHz

Test Conditions and Bias Sequence

Measurements performed with I and Q (IF) ports connected to an external 90° Hybrid, LO Power = 0 dBm and IF = 2.5 GHz, -10 dBm, unless otherwise stated.

$V_{LOA1} = V_{LOA2} = 4\text{ V}$, $I_{LOA1,2} = 205\text{ mA}$; $V_{LPA12} = 3.5\text{ V}$, Adjust V_{G1} around -0.4 V to get $I_{LPA12} = 120\text{ mA}$

$V_{MPA} = 4.5\text{ V}$, Adjust V_{G2} to get $I_{MPA} = 120\text{ mA}$, $I_{TOTAL} = 445\text{ mA}$, $V_{C1} = V_{C2} = -4\text{ V}$.

Typical Bias Sequence							
	G_{MAX}						G_{MIN}
V_{C1} (V)	-4	-2	-1	0	0	0	0
V_{C2} (V)	-4	-4	-4	-4	-2	-1	0

More dynamic range can be achieved using V_{G2} over $(-0.4\text{ to }-1\text{ V})$ and V_{G1} over $(-0.4\text{ to }-1\text{ V})$

Pin Names and Description

Pin Number	Label	Description
1	N/C	Not Connected
2	GND	Ground
3	LO	Local Oscillator Input. AC Coupled and Matched to 50 Ω
4	GND	Ground
5	N/C	Not Connected
6	N/C	Not Connected
7	N/C	Not Connected
8	N/C	Not Connected
9	VLOA1	LOA Stage1 Drain Bias
10	VLOA2	LOA Stage2 Drain Bias
11	N/C	Not Connected
12	N/C	Not Connected
13	VC1	Control Line Number 1 (See Bias Sequence Description)
14	VC2	Control Line Number 2 (See Bias Sequence Description)
15	VG2	MPA Gate Bias
16	VMPA	MPA Drain Bias
17	N/C	Not Connected
18	GND	Ground
19	RFOUT	RF Output. AC Coupled and Matched to 50 Ω
20	GND	Ground
21	N/C	Not Connected
22	N/C	Not Connected
23	N/C	Not Connected
24	VLPA1, VLPA2	LPA Stage 1, 2 Drain Bias
25	VG1	LPA Stage 1, 2 Gate Bias
26	N/C	Not Connected
27	Q	IF Q Input
28	GND	Ground
29	N/C	Not Connected
30	I	IF I Input
31	GND	Ground
32	N/C	Not Connected

Package Marking and Dimensions

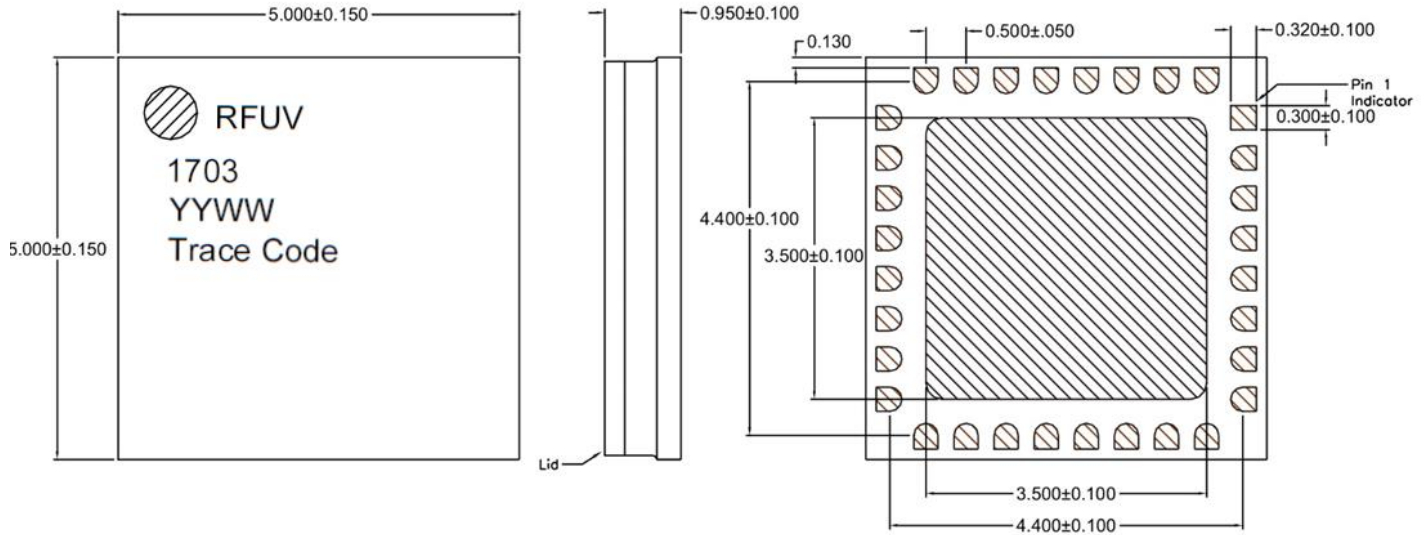

All dimensions are in millimeters

Marking:

RFUV1703: Part number

YY: Part Assembly year

WW: Part Assembly week

Assembly Notes

Compatible with lead-free soldering processes with 260°C peak reflow temperature.

This package is air-cavity and non-hermetic, and therefore cannot be subjected to aqueous washing. The use of no-clean solder to avoid washing after soldering is highly recommended.

Contact plating: Ni-Au.

Solder rework not recommended.

Recommended Soldering Profile

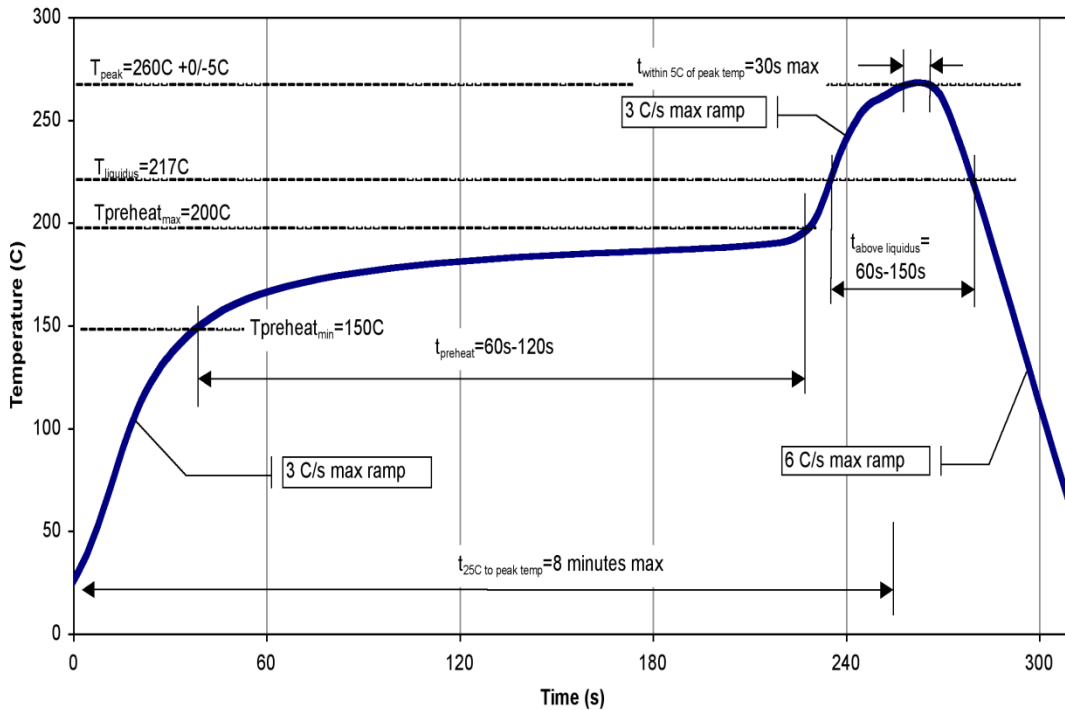

Handling Precautions

Parameter	Rating	Standard
ESD – Human Body Model (HBM)	Class 1A	JESD22-A114
ESD – Charged Device Model (CDM)	Class C2	JESDE22-C101C
MSL – Convection Reflow 260 °C	Level 2	JEDEC standard IPC/JEDEC J-STD-020



Caution!
ESD-Sensitive Device

RoHS Compliance

This part is compliant with 2011/65/EU RoHS directive (Restrictions on the Use of Certain Hazardous Substances in Electrical and Electronic Equipment) as amended by Directive 2015/863/EU.

This product also has the following attributes:

- Lead Free
- Antimony Free
- TBBP-A (C₁₅H₁₂Br₄O₂) Free
- PFOS Free
- SVHC Free

Contact Information

For the latest specifications, additional product information, worldwide sales and distribution locations:

Web: www.qorvo.com

Tel: 1-844-890-8163

Email: customer.support@qorvo.com

Important Notice

The information contained herein is believed to be reliable; however, Qorvo makes no warranties regarding the information contained herein and assumes no responsibility or liability whatsoever for the use of the information contained herein. All information contained herein is subject to change without notice. Customers should obtain and verify the latest relevant information before placing orders for Qorvo products. The information contained herein or any use of such information does not grant, explicitly or implicitly, to any party any patent rights, licenses, or any other intellectual property rights, whether with regard to such information itself or anything described by such information. **THIS INFORMATION DOES NOT CONSTITUTE A WARRANTY WITH RESPECT TO THE PRODUCTS DESCRIBED HEREIN, AND QORVO HEREBY DISCLAIMS ANY AND ALL WARRANTIES WITH RESPECT TO SUCH PRODUCTS WHETHER EXPRESS OR IMPLIED BY LAW, COURSE OF DEALING, COURSE OF PERFORMANCE, USAGE OF TRADE OR OTHERWISE, INCLUDING THE IMPLIED WARRANTIES OF MERCHANTABILITY AND FITNESS FOR A PARTICULAR PURPOSE.**

Without limiting the generality of the foregoing, Qorvo products are not warranted or authorized for use as critical components in medical, life-saving, or life-sustaining applications, or other applications where a failure would reasonably be expected to cause severe personal injury or death.

Copyright 2020 © Qorvo, Inc. | Qorvo is a registered trademark of Qorvo, Inc.



Компания «ЭлектроПласт» предлагает заключение долгосрочных отношений при поставках импортных электронных компонентов на взаимовыгодных условиях!

Наши преимущества:

- Оперативные поставки широкого спектра электронных компонентов отечественного и импортного производства напрямую от производителей и с крупнейших мировых складов;
- Поставка более 17-ти миллионов наименований электронных компонентов;
- Поставка сложных, дефицитных, либо снятых с производства позиций;
- Оперативные сроки поставки под заказ (от 5 рабочих дней);
- Экспресс доставка в любую точку России;
- Техническая поддержка проекта, помощь в подборе аналогов, поставка прототипов;
- Система менеджмента качества сертифицирована по Международному стандарту ISO 9001;
- Лицензия ФСБ на осуществление работ с использованием сведений, составляющих государственную тайну;
- Поставка специализированных компонентов (Xilinx, Altera, Analog Devices, Intersil, Interpoint, Microsemi, Aeroflex, Peregrine, Syfer, Eurofarad, Texas Instrument, Miteq, Cobham, E2V, MA-COM, Hittite, Mini-Circuits, General Dynamics и др.);

Помимо этого, одним из направлений компании «ЭлектроПласт» является направление «Источники питания». Мы предлагаем Вам помощь Конструкторского отдела:

- Подбор оптимального решения, техническое обоснование при выборе компонента;
- Подбор аналогов;
- Консультации по применению компонента;
- Поставка образцов и прототипов;
- Техническая поддержка проекта;
- Защита от снятия компонента с производства.



Как с нами связаться

Телефон: 8 (812) 309 58 32 (многоканальный)

Факс: 8 (812) 320-02-42

Электронная почта: org@eplast1.ru

Адрес: 198099, г. Санкт-Петербург, ул. Калинина, дом 2, корпус 4, литера А.