

LOC		DIST		REVISIONS			
ES	00	P	LTH	DESCRIPTION	DATE	DWN	APVD
		J9		REV PER ECR-12-020199	22NOV2012	CZ	SZ



THIS DRAWING IS A CONTROLLED DOCUMENT.		DWN D. ZHU	Z0DEC2007		TE Connectivity	
DIMENSIONS: INCHES		CHK S. ZHAO	Z0DEC2007		NAME VER RECEP ASSEMBLY SHORT GUIDES, PRESS FIT MULTI-BEAM XLE	
TOLERANCES UNLESS OTHERWISE SPECIFIED:		APVD S. ZHAO	-	PRODUCT SPEC		
0 PLC ± .01		108-2292		APPLICATION SPEC		
1 PLC ± .01		114-13251		SIZE A1		
2 PLC ± .005		WEIGHT		CAGE CODE 00779		
3 PLC ± .0020		CUSTOMER DRAWING		DRAWING NO 6450860		
ANGLES *2°		SCALE N/A		SHEET 1		
FINISH -3		RESTRICTED TO		OF 28		
MATERIAL -2		REV K2				

LOC	DIST	REV	DATE	BY	APPV
ES	00				

- 1 "AMP", PART NUMBER AND DATE CODE TO BE MARKED IN AREA SHOWN
PARTS UNDER 2.00 LONG MAY BE MARKED ON BOTH SIDES
- 2 MATERIAL: HOUSING - GLASS FILLED HIGH TEMP THERMO PLASTIC, UL94 V-0, BLACK.
SIGNAL CONTACT - HIGH CONDUCTIVITY COPPER ALLOY
POWER CONTACT - HIGH CONDUCTIVITY COPPER ALLOY
LP CONTACT - HIGH CONDUCTIVITY COPPER ALLOY
- 3 CONTACT PLATING - NOBLE METAL PLATING ON CONTACT FUNCTIONAL AREA
OF POWER AND SIGNAL CONTACTS
- 4 MECHANICAL CONNECTOR KEEP OUT ZONE
- 5 DATUM AND BASIC DIMENSIONS ESTABLISHED BY CUSTOMER
- 6 PCB - ALL HOLE DIAMETERS ARE FINISHED HOLE SIZES
- 7 PCB - 0.0453 ±.0010 DRILLED HOLES PLATED WITH .0003 MIN Sn
OVER .001 TO .003 Cu PLATING TO ACHIEVE A .040 HOLE
- 8 FOR P/S/LP CONFIGURATION, PLEASE REFER TO SHEET 3.
- 9 FOR LP/S/P CONFIGURATION, PLEASE REFER TO SHEET 3.
- 10 VARIABLE DIMENSIONS SHOW ON TABLE.
- 11 FOR LP/S/LP CONFIGURATION, PLEASE REFER TO SHEET 3.
- 12 SPECIAL DIMENSIONS SEE SHEET 3
- 13 RECOMMEND USING CUSTOMER SUPPLIED SCREWS TO SECURE TO BOARD
TYCO P/N: 19024-2. RECOMMEND TORQUE IS TBD.
ASSUMING A CARD THICKNESS OF TBD, FINAL SCREW LENGTH AND CARD THICKNESS ARE FACTORS TO BE
CONSIDERED IF APPLYING A SCREW FOR AN APPLICATION AND MAY VARY FOR EACH APPLICATION.

W	U	K	S	T	D	R	L	DESCRIPTION	PART NUMBER
1.850	.250	.250	.170	1.690	.425	1.100	2.040	2P + 24S + 2P	5-6450860-2
1.185	-	-	.1025	1.025	.2725	.705	1.375	2LP + 16S + 2LP	4-6450860-8
2.850	.250	.250	.170	2.690	.925	1.600	3.040	4P + 24S + 4P	4-6450860-7
2.150	.250	.250	.170	1.990	.475	1.400	2.340	2P + 32S + 2P	4-6450860-6
2.705	.115	.170	.170	2.545	1.800	2.1575	2.895	3ACP+3P+12S+2LP	4-6450860-5
4.450	.250	.250	.170	4.290	1.925	2.200	4.640	8P + 8S + 8P	4-6450860-4
1.400	.250	.250	.145	1.240	.425	.700	1.590	2P + 8S + 2P	4-6450860-3
1.330	.250	-	.1275	1.170	.2725	.5725	1.520	2LP + 8S + 2P	4-6450860-2
2.400	.200	.200	.145	2.240	.775	1.350	2.590	4HDP + 20S + 4HDP	4-6450860-1
1.350	-	-	.170	1.190	.175	.850	1.540	1P + 24S + 1P	4-6450860-0
1.360	-	.230	.1275	1.200	.4775	.8525	1.550	4LP + 12S + 1P	3-6450860-9
2.550	.250	.250	.170	2.390	.475	1.800	2.740	2P + 48S + 2P	3-6450860-6
3.850	.250	.250	.170	3.690	1.425	2.100	4.040	6P + 24S + 6P	3-6450860-5
1.075	-	-	.1025	.915	.2725	.480	1.265	2LP + 8S + 3LP	3-6450860-4
1.330	.250	-	.1275	1.170	.2725	.5725	1.520	2LP + 8S + 2P	3-6450860-3
1.800	.250	.250	.220	1.640	.450	.950	1.990	2P + 16S + 2P	3-6450860-2
2.870	.230	.230	.1525	2.710	.6550	2.2125	3.060	4LP + 60S + 4LP	3-6450860-1
.975	-	-	.1025	.815	.2725	.380	1.165	2LP + 4S + 3LP	3-6450860-0
1.950	.250	.250	.170	1.790	.475	1.200	2.140	2P + 24S + 2P	2-6450860-9
2.550	.250	.250	.170	2.390	.925	1.300	2.740	4P + 12S + 4P	2-6450860-8
5.635	.250	.250	.170	5.475	.475	1.885	5.825	2P + 32S + 4LP + 14P	2-6450860-6
3.570	.250	.230	.1525	3.410	2.1125	2.8375	3.760	18LP + 24S + 2P	2-6450860-5
6.050	.250	.250	.145	5.890	1.950	3.850	6.240	8P + 72S + 8P	2-6450860-1
1.950	.250	.250	.170	1.790	.475	1.200	2.140	2P + 24S + 2P	2-6450860-0
3.350	.200	.200	.170	3.190	1.175	1.850	3.540	6HDP + 24S + 6HDP	1-6450860-7
-	.250	.230	.1275	2.205	.7325	1.4075	2.555	6LP + 24S + 3P	1-6450860-6
2.450	.200	.200	.170	2.290	.775	1.350	2.640	4HDP + 20S + 4HDP	1-6450860-5
2.150	.200	.200	.170	1.990	.775	1.050	2.340	4HDP + 8S + 4HDP	1-6450860-4
2.450	-	.250	.170	2.290	.925	1.200	2.640	4P + 8S + 4P	1-6450860-3
3.450	-	.250	.170	3.290	1.425	1.700	3.640	6P + 8S + 6P	1-6450860-2
2.800	.300	.250	.170	2.640	.925	1.700	2.990	4P + 28S + 3ACP	1-6450860-0
2.510	-	-	.170	2.350	.455	1.6875	2.700	1P+2LP+48S+2LP+1P	6450860-9
2.800	.300	.250	.170	2.640	.925	1.700	2.990	4P + 28S + 3ACP	6450860-7
2.425	.250	.300	.170	2.265	.500	1.175	2.615	2ACP + 24S + 4P	6450860-6
3.665	-	.230	.1025	3.505	.7325	1.4075	3.855	6LP + 24S + 10P	6450860-5
2.530	-	.250	.170	2.370	1.175	1.9825	2.720	5P + 32S + 2LP	6450860-4
5.545	.230	.250	.195	5.385	2.975	4.2325	5.735	12P + 48S + 8LP	6450860-3
5.200	.200	.300	.195	5.040	1.150	2.475	5.390	4ACP + 48S + 12HDP	6450860-2
.985	-	-	.1025	.825	.2725	.505	1.175	2LP + 8S + 2LP	6450860-1
D	T	S	K	U	W	R	L	DESCRIPTION	PART NUMBER

THIS DRAWING IS A CONTROLLED DOCUMENT.

OWN: D. ZHU
 CH: S. ZHAO
 APV: S. ZHAO

DATE: 20DEC2007

NAME: VER RECEPT ASSEMBLY SHORT GUIDES, PRESS FIT MULTI-BEAM XLE

PRODUCT SPEC: 108-2292

APPLICATION SPEC: 114-13251

SIZE: A1
 CAGE CODE: 6450860
 DRAWING NO: 100779

SCALE: N/A
 SHEET: 2 OF 28
 REV: K2

CUSTOMER DRAWING

LOC	DIST	REVISIONS					
ES	00	P	LTH	DESCRIPTION	DATE	DWN	APVD
		-	-	SEE SHEET 1	-	-	-



FOR P/S/LP CONFIGURATION
 UNSPECIFIED DIMENSION REFER TO SHEET 1



FOR LP/S/P CONFIGURATION
 UNSPECIFIED DIMENSION REFER TO SHEET 1



FOR PART 2-6450860-6



FOR LP/S/LP(6450860-1 AND 3-6450860-0) CONFIGURATION
 UNSPECIFIED DIM REFER TO SHEET 1

THIS DRAWING IS A CONTROLLED DOCUMENT.		DWN: D. ZHU CHK: S. ZHAO	20DEC2007 20DEC2007	TE Connectivity VER RECEP ASSEMBLY SHORT GUIDES, PRESS FIT MULTI-BEAM XLE
DIMENSIONS: INCHES	TOLERANCES UNLESS OTHERWISE SPECIFIED:	APVD: S. ZHAO	NAME: VER RECEP ASSEMBLY	
	0 PLC ±	PRODUCT SPEC	SIZE: A1	CAGE CODE: 6450860 DRAWING NO: 100779 APPLICATION SPEC: 108-2292 ANGLE: 114-13251 FINISH: ±.0020
	1 PLC ±.01	RESTRICTED TO	SCALE: N/A	
MATERIAL:	FINISH:	WEIGHT:	SHEET 3 OF 28	REV: K2
CUSTOMER DRAWING		DATE: 20DEC2007		

LOC	DIST	REVISIONS			
		REV	DATE	BY	APPV
ES	00	-	-	-	-
		SEE SHEET 1			

PART NUMBER	ROWS	SIGNAL														POWER																	
		LP8	LP7	LP6	LP5	LP4	LP3	LP2	LPI	I2	I1	I0	9	8	7	6	5	4	3	2	1	P12	P11	P10	P9	P8	P7	P6	P5	P4	P3	P2	P1
6450860-3	D									AP	AP	AP	AP	AP	AP	AP	AP	AP	AP	AP													
	C									AP	AP	AP	AP	AP	AP	AP	AP	AP	AP	AP													
	B	LS1	LS1	LS1	LS1	LS1	LS1	LS1		AP	AP	AP	AP	AP	AP	AP	AP	AP	AP	AP	GS	GS	GS	GS	GS	GS	GS	GS	GS	GS	GS	GS	
	A									AP	AP	AP	AP	AP	AP	AP	AP	AP	AP	AP													

12P + 48S + 8LP



THIS DRAWING IS A CONTROLLED DOCUMENT.		OWN: D. ZHU	20DEC2007		TE Connectivity
DIMENSIONS: INCHES		CHK: S. ZHAO	20DEC2007		VER RECEP ASSEMBLY SHORT GUIDES, PRESS FIT MULTI-BEAM XLE
TOLERANCES UNLESS OTHERWISE SPECIFIED:		APV: S. ZHAO		NAME	
0 PLC ±.01		PRODUCT SPEC		SIZE: CAGE CODE: DRAWING NO: RESTRICTED TO	
1 PLC ±.01		108-2292		A100779C=6450860	
2 PLC ±.01		APPLICATION SPEC		SCALE: N/A SHEET 5 OF 28 REV: K2	
3 PLC ±.005		114-13251			
4 PLC ±.0020		WEIGHT: -			
ANGLES: ±.2°		FINISH: -			
MATERIAL: -		CUSTOMER DRAWING			

LOC		DIST		REVISIONS			
ES	00	REV	DATE	BY	CHKD	APVD	
-	-	SEE SHEET 1	-	-	-	-	-

PART NUMBER	ROWS	POWER				SIGNAL					POWER		HD
		P6	P5	P4	P3	6	5	4	3	2	1	P2	
6450860-6	D	GS	GS	GS	GS	AP	AP	AP	AP	AP	AP	GS	GS
	C					AP	AP	AP	AP	AP	AP		
	B					AP	AP	AP	AP	AP	AP		
	A					AP	AP	AP	AP	AP	AP		
2ACP + 24S + 4P													

PART NUMBER	ROWS	LP2	LPI	SIGNAL								POWER					HD
				8	7	6	5	4	3	2	1	P5	P4	P3	P2	P1	
6450860-4	D	LSI		AP	AP	AP	AP	AP	AP	AP	AP	AP	GS	GP	GS	GP	GP
	C			AP	AP	AP	AP	AP	AP	AP	AP						
	B			AP	AP	AP	AP	AP	AP	AP	AP						
	A			AP	AP	AP	AP	AP	AP	AP	AP						
5P + 32S + 2LP																	

NO CONTACT LOADED

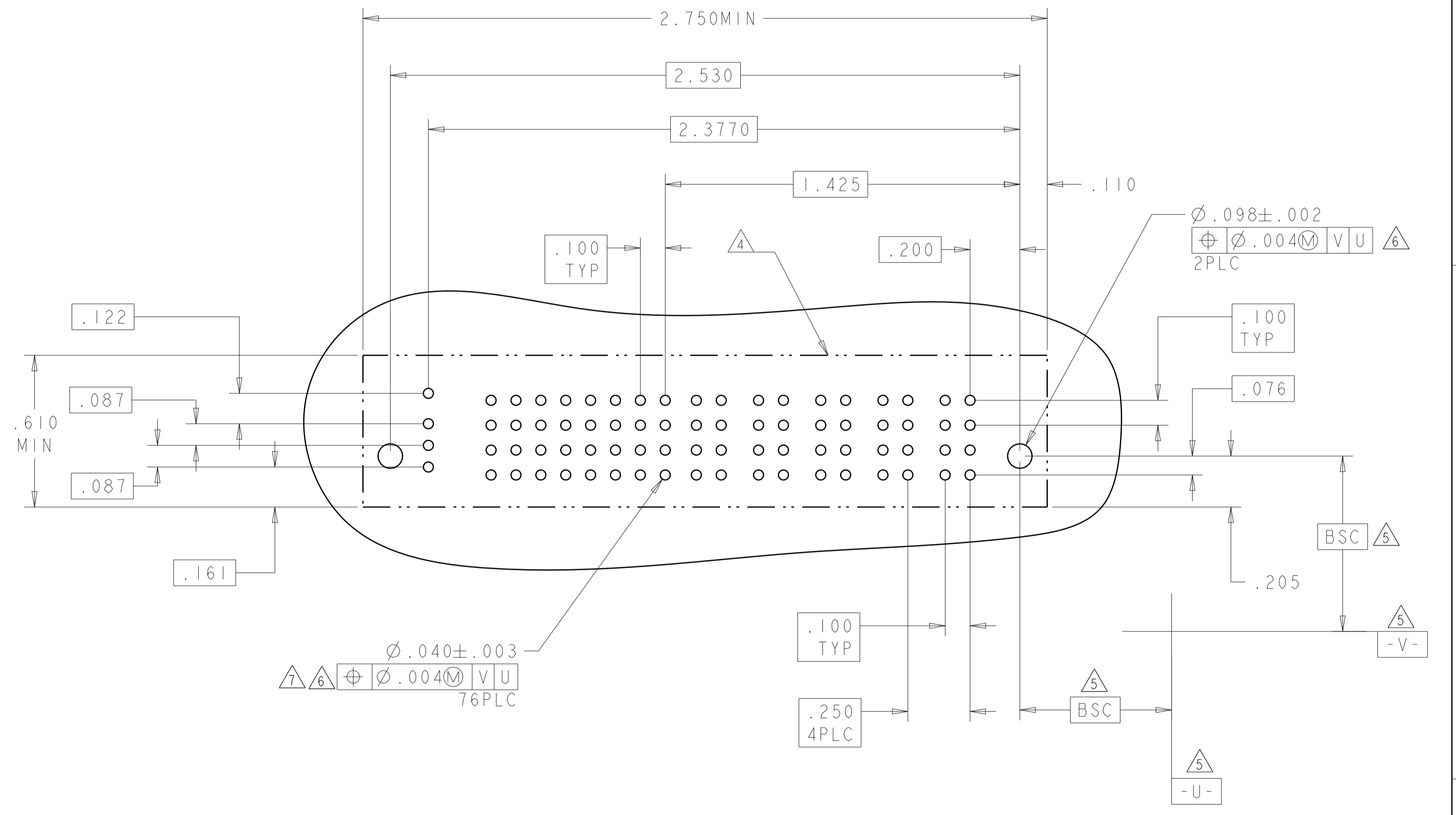
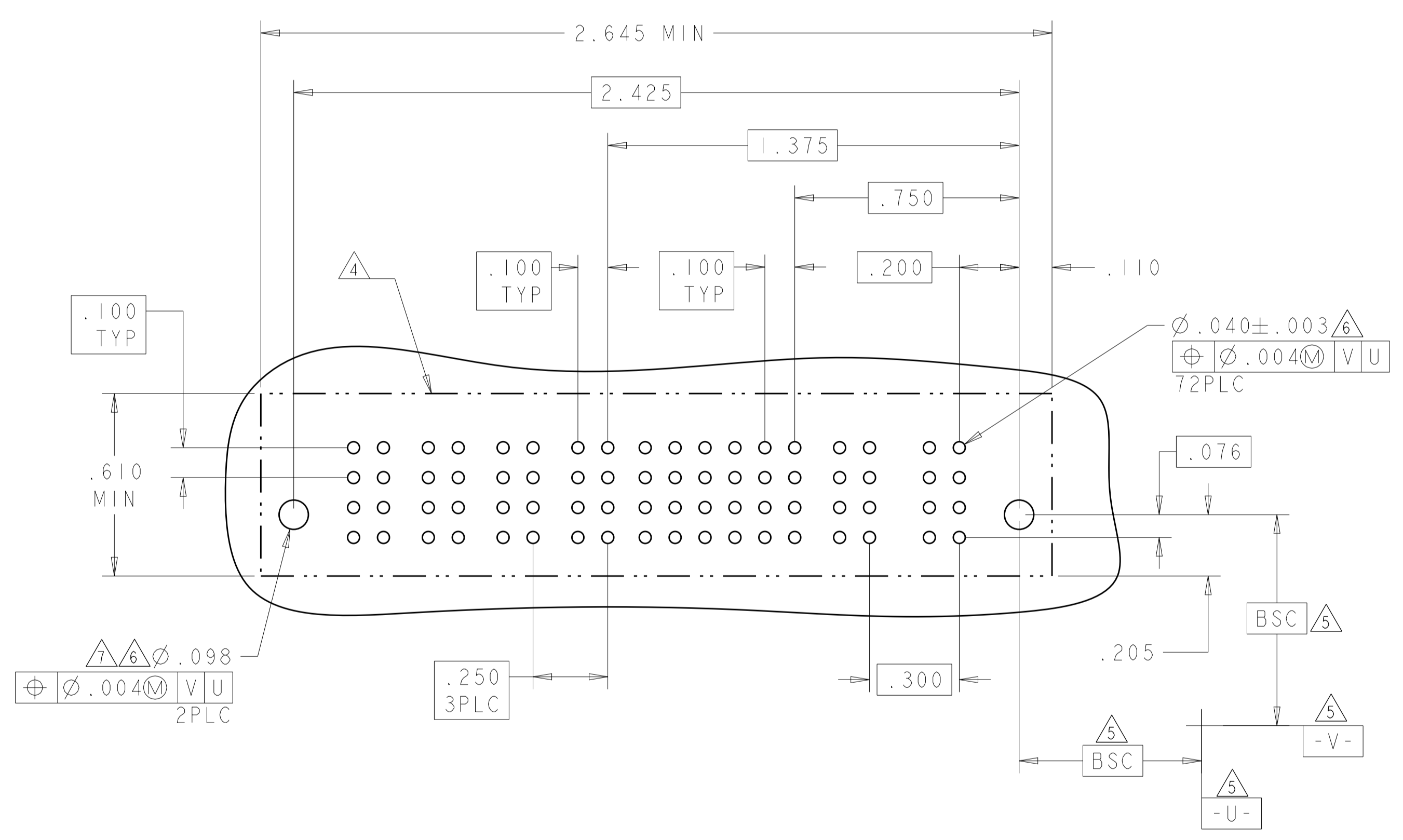

THIS DRAWING IS A CONTROLLED DOCUMENT.

DIMENSIONS: INCHES	TOLERANCES UNLESS OTHERWISE SPECIFIED: 0 PLC ±. 1 PLC ±.01 2 PLC ±.01 3 PLC ±.005 4 PLC ±.0020 ANGLES ±.2°	FINISH	FINISH
-----------------------	--	--------	--------

OWN: D. ZHU	20DEC2007	TE Connectivity VER RECEP ASSEMBLY SHORT GUIDES, PRESS FIT MULTI-BEAM XLE			
CHK: S. ZHAO	20DEC2007				
APVD: S. ZHAO					
NAME					
PRODUCT SPEC	108-2292	SIZE: A1	CAGE CODE: 100779	DRAWING NO: 6450860	RESTRICTED TO:
APPLICATION SPEC	114-13251	WEIGHT			
CUSTOMER DRAWING		SCALE: N/A	SHEET: 6	OF: 28	REV: K2

LOC		DIST		REVISIONS				
ES	00	P	LTN	DESCRIPTION	DATE	DMN	APVD	
		-		SEE SHEET 1				

PART NUMBER	ROWS	POWER										SIGNAL						POWER						
		P10	P9	P8	P7	P6	P5	P4	P3	P2	P1	6	5	4	3	2	1	LP6	LP5	LP4	LP3	LP2	LP1	
6450860-5	D C B A	GS	GS	GS	GS	GS	GS	GS	GS	GS	GS	AP	AP	AP	AP	AP	AP	LSI			LSI			LSI
		GS	GS	GS	GS	GS	GS	GS	GS	GS	GS	AP	AP	AP	AP	AP	AP							
		GS	GS	GS	GS	GS	GS	GS	GS	GS	GS	AP	AP	AP	AP	AP	AP							
		GS	GS	GS	GS	GS	GS	GS	GS	GS	GS	AP	AP	AP	AP	AP	AP							



THIS DRAWING IS A CONTROLLED DOCUMENT. DWN: D.ZHU, 20DEC2007
 CHK: S.ZHAO, 20DEC2007
 APVD: S.ZHAO

DIMENSIONS: INCHES
 TOLERANCES UNLESS OTHERWISE SPECIFIED:
 0 PLC ±
 1 PLC ±.01
 2 PLC ±.01
 3 PLC ±.005
 4 PLC ±.0020
 ANGLES ±2°

MATERIAL: -
 FINISH: -

PRODUCT SPEC: 108-2292
 APPLICATION SPEC: 114-13251
 WEIGHT: -

NAME: VER RECEP ASSEMBLY SHORT GUIDES, PRESS FIT MULTI-BEAM XLE
 SIZE: A1
 CAGE CODE: 100779
 DRAWING NO: 6450860
 RESTRICTED TO: -

CUSTOMER DRAWING
 SCALE: N/A
 SHEET: 7 OF 28
 REV: K2

4805 (3/11)

LOC	DIST	REVISIONS			
P	LTN	DESCRIPTION	DATE	DMN	APVD
-	-	SEE SHEET 1	-	-	-

PART NUMBER	ROWS	POWER				SIGNAL					POWER					
		P7	P6	P5		7	6	5	4	3	2	1	P4	P3	P2	P1
6450860-7	D C B A	HD	GS	GS			AP	AP	AP	AP	AP		GS	GS	GS	GS
							AP	AP	AP	AP	AP					
							AP	AP	AP	AP	AP					
							AP	AP	AP	AP	AP					
4P + 28S + 3ACP																

PART NUMBER	ROWS	POWER		SIGNAL		POWER	
		P4	P3	2	1	P2	P1
6450860-1	D C B A	LSI	LSI	AP	AP	LSI	LSI
				AP	AP		
				AP	AP		
				AP	AP		
2LP + 8S + 2LP							

NO CONTACTS LOADED



THIS DRAWING IS A CONTROLLED DOCUMENT. DWN: D.ZHU, 20DEC2007, CHK: S.ZHAO, 20DEC2007, APVD: S.ZHAO

DIMENSIONS: INCHES. TOLERANCES UNLESS OTHERWISE SPECIFIED: 0 PLC ±, 1 PLC ±.01, 2 PLC ±.01, 3 PLC ±.005, 4 PLC ±.0020, ANGLES ±.020, FINISH: #2

MATERIAL: -

PRODUCT SPEC: 108-2292
 APPLICATION SPEC: 114-13251
 WEIGHT: -

CUSTOMER DRAWING

NAME: VER RECEP ASSEMBLY SHORT GUIDES, PRESS FIT MULTI-BEAM XLE
 SIZE: A1
 CAGE CODE: 100779
 DRAWING NO: 6450860
 SCALE: N/A
 SHEET: 8 OF 28
 REV: K2

RESTRICTED TO

LOC	DIST	REVISIONS			
ES	00	REV	DATE	BY	APPV
		1	SEE SHEET 1		

PART NUMBER	ROWS	POWER			SIGNAL											POWER					
		P2	LP4	LP3	12	11	10	9	8	7	6	5	4	3	2	1	LP2	LPI	PI		
6450860-9	D	GP	LSI	LSI	AP	AP	AP	AP	AP	AP	AP	AP	AP	AP	AP	AP	AP	AP	AP	AP	
	C				AP	AP	AP	AP	AP	AP	AP	AP	AP	AP	AP	AP	AP	AP	AP	AP	
	B				AP	AP	AP	AP	AP	AP	AP	AP	AP	AP	AP	AP	AP	AP	AP	AP	AP
	A				AP	AP	AP	AP	AP	AP	AP	AP	AP	AP	AP	AP	AP	AP	AP	AP	AP
IP + 2LP + 48S + 2LP + IP																					

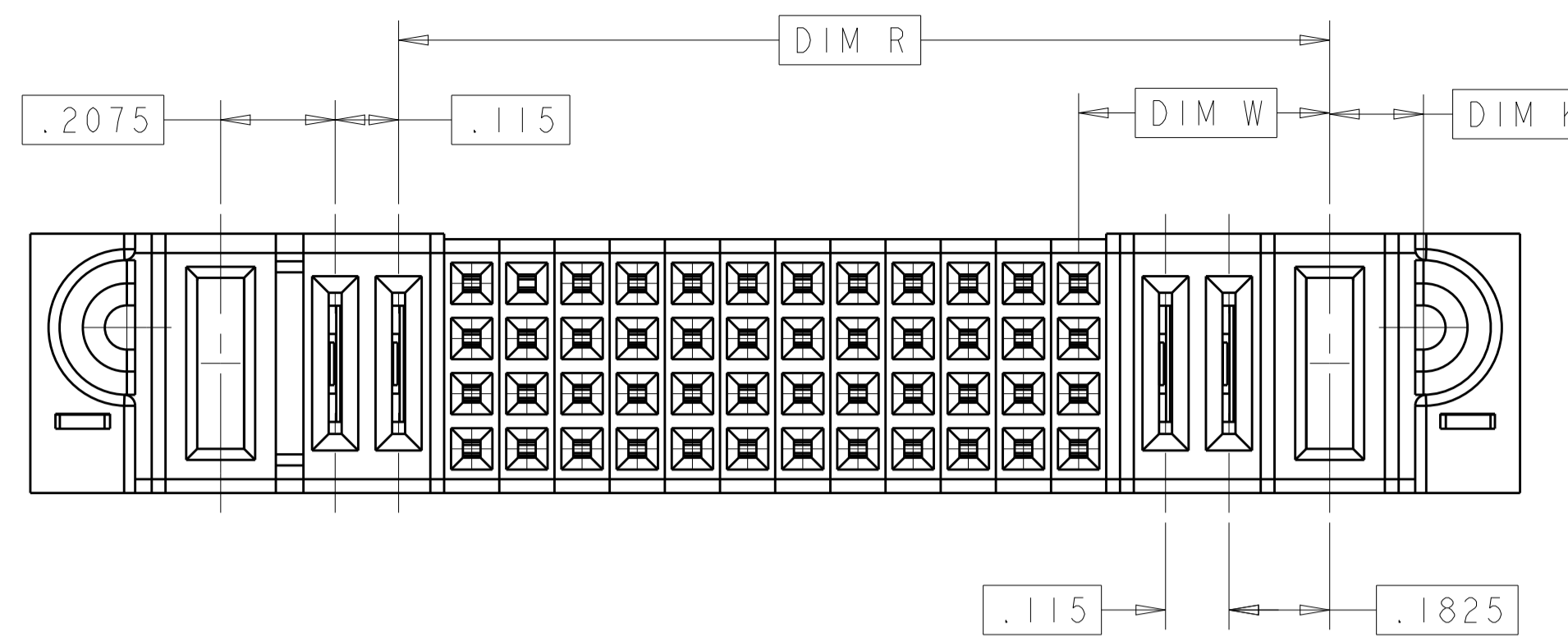

P/N: 6450860-9 CONFIGURATION
 UNSPECIFIED DIMENSION REFER TO SHEET 1

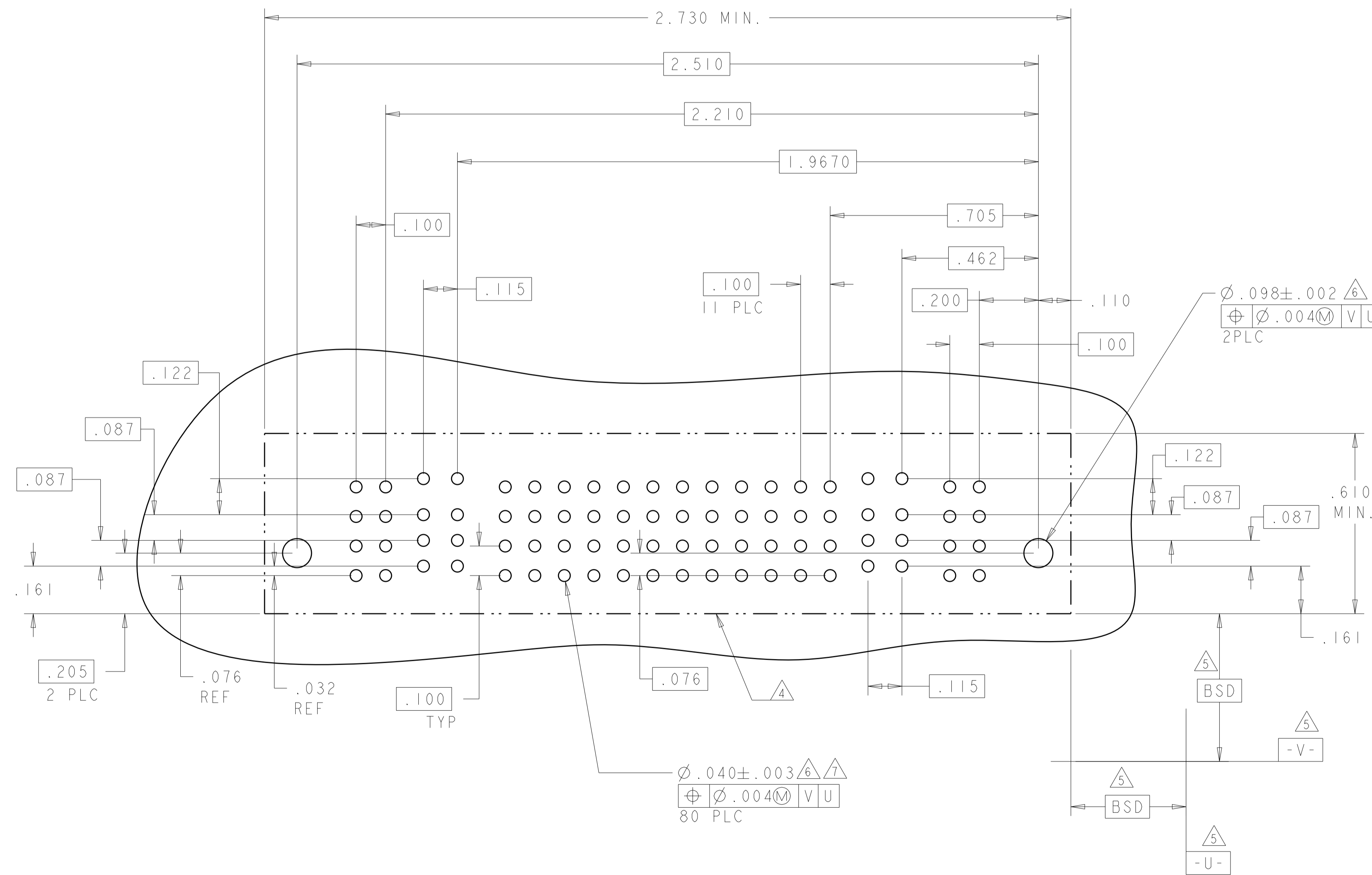

THIS DRAWING IS A CONTROLLED DOCUMENT.		OWN: D. ZHU	20DEC2007	TE Connectivity
DIMENSIONS: INCHES		CHK: S. ZHAO	20DEC2007	
DIMENSIONS: INCHES 0 PLC ±. 1 PLC ±.01 2 PLC ±.01 3 PLC ±.005 4 PLC ±.0020 ANGLES ±.2°		TOLERANCES UNLESS OTHERWISE SPECIFIED: PRODUCT SPEC: 108-2292 APPLICATION SPEC: 114-13251 WEIGHT: -		NAME: VER RECEP ASSEMBLY SHORT GUIDES, PRESS FIT MULTI-BEAM XLE
MATERIAL: -		APVD: S. ZHAO PRODUCT SPEC: 108-2292 APPLICATION SPEC: 114-13251 WEIGHT: -		SIZE: A1 CAGE CODE: 100779 DRAWING NO: 6450860
CUSTOMER DRAWING		SCALE: N/A		SHEET 9 OF 28 REV: K2

LOC	DIST	REVISIONS			
P	LTN	DESCRIPTION	DATE	OWN	APVD
ES	00	SEE SHEET 1			

PART NUMBER	ROWS	POWER						SIGNAL		POWER					
		P12	P11	P10	P9	P8	P7	2	1	P6	P5	P4	P3	P2	P1
1-6450860-2	D C B A	GS	GS	GS	GS	GS	GS	AP	AP	GS	GS	GS	GS	GS	GS
		HD						HD						HD	
		6P + 8S + 6P													

PART NUMBER	ROWS	POWER				SIGNAL		POWER			
		P8	P7	P6	P5	2	1	P4	P3	P2	P1
1-6450860-3	D C B A	GS	GS	GS	GS	AP	AP	GS	GS	GS	GS
		HD				HD				HD	
		4P + 8S + 4P									

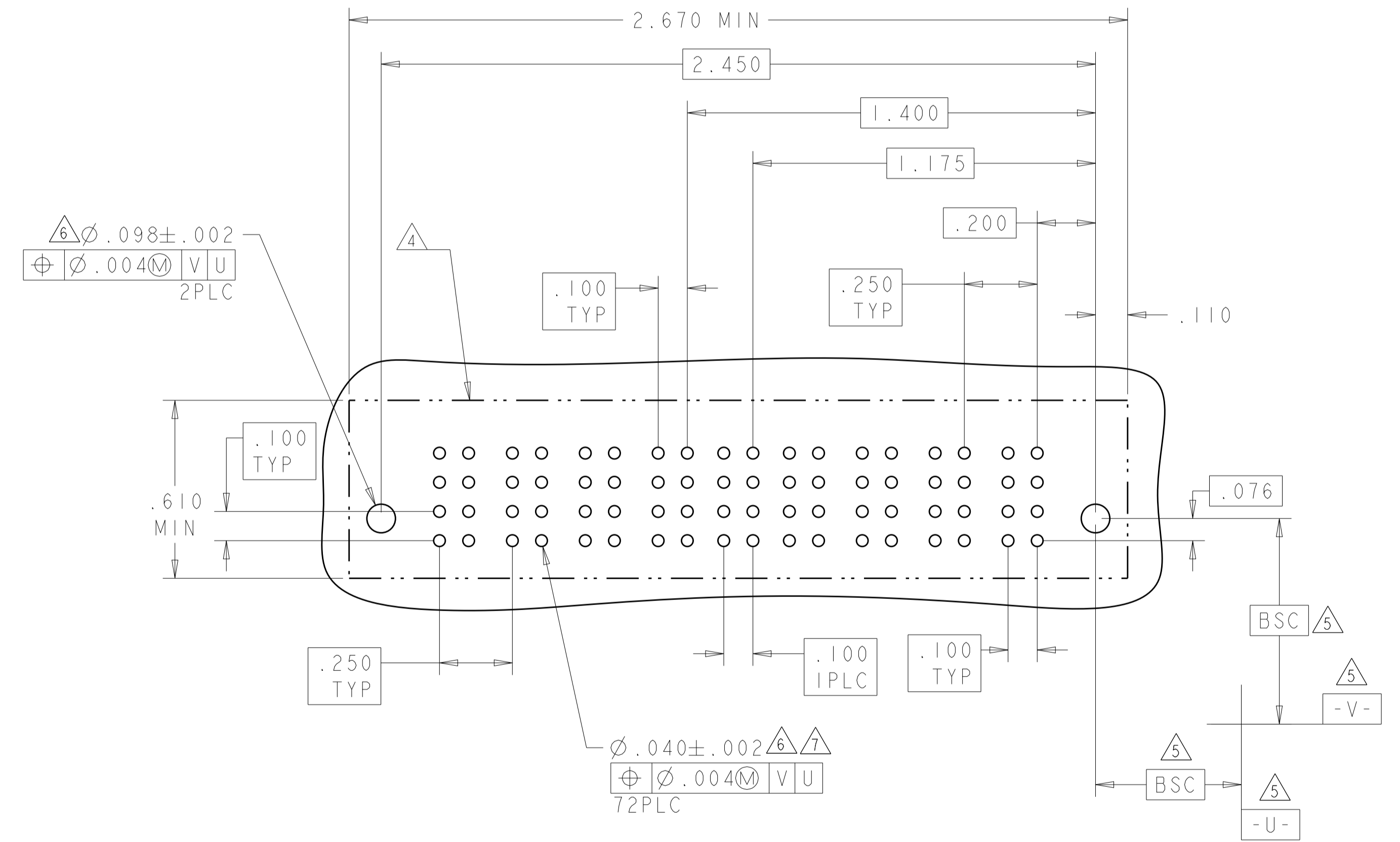

THIS DRAWING IS A CONTROLLED DOCUMENT.

DIMENSIONS:	TOLERANCES UNLESS OTHERWISE SPECIFIED:	OWN: D. ZHU	20DEC2007		TE Connectivity VER RECEPT ASSEMBLY SHORT GUIDES, PRESS FIT MULTI-BEAM XLE
INCHES	0 PLC ± .01 2 PLC ± .01 3 PLC ± .01 4 PLC ± .005 ANGLES ± .0020	CHK: S. ZHAO	20DEC2007		
MATERIAL:	FINISH:	APVD: S. ZHAO	NAME:	PRODUCT SPEC: 108-2292	RESTRICTED TO:
				APPLICATION SPEC: 114-13251	SIZE: A
				WEIGHT:	CAGE CODE: 100779
					DRAWING NO: 6450860
				CUSTOMER DRAWING	SCALE: N/A
					SHEET 11 OF 28
					REV: K2

LOC	DIST	REVISIONS			
P	LTN	DESCRIPTION	DATE	DMN	APVD
ES	00	SEE SHEET 1	-	-	-

PART NUMBER	ROWS	POWER				SIGNAL		POWER			
		P8	P7	P6	P5	2	1	P4	P3	P2	P1
1-6450860-4	D C B A	GS	GS	GS	GS	AP	AP	GS	GS	GS	GS
						AP	AP				
						AP	AP				
						AP	AP				
4HDP + 8S + 4HDP											

PART NUMBER	ROWS	POWER				SIGNAL					POWER			
		P8	P7	P6	P5	5	4	3	2	1	P4	P3	P2	P1
1-6450860-5	D C B A	GS	GS	GS	GS	AP	AP	AP	AP	AP	GS	GS	GS	GS
						AP	AP	AP	AP	AP				
						AP	AP	AP	AP	AP				
						AP	AP	AP	AP	AP				
4HDP + 20S + 4HDP														



THIS DRAWING IS A CONTROLLED DOCUMENT.

DIMENSIONS: INCHES	TOLERANCES UNLESS OTHERWISE SPECIFIED: 0 PLC ±. 1 PLC ±.01 2 PLC ±.01 3 PLC ±.005 4 PLC ±.0020 ANGLES ±7°	FINISH	DMN: D. ZHU CHK: S. ZHAO APVD: S. ZHAO	PRODUCT SPEC: 108-2292 APPLICATION SPEC: 114-13251	NAME: VER RECEP ASSEMBLY SHORT GUIDES, PRESS FIT MULTI-BEAM XLE
MATERIAL	WEIGHT	SCALE: N/A	CAGE CODE: A100779	DRAWING NO: C=6450860	RESTRICTED TO: K2

CUSTOMER DRAWING

LOC		DIST		REVISIONS			
ES	00	P	LTN	DESCRIPTION	DATE	DWN	APVD
-	-	-	-	SEE SHEET 1	-	-	-

PART NUMBER	ROWS	POWER		SIGNAL						POWER			
		P4	P3	6	5	4	3	2	1	P2	P1		
2-6450860-0	D	GS	GS	AP	AP	AP	AP	AP	AP	GS	GS		
	C			AP	AP	AP	AP	AP	AP				
	B			AP	AP	AP	AP	AP	AP				
	A			AP	AP	AP	AP	AP	AP				
		2P + 24S + 2P											

PART NUMBER	ROWS	POWER				SIGNAL			POWER				
		P8	P7	P6	P5	3	2	1	P4	P3	P2	P1	
2-6450860-8	D	GS	GS	GS	GS	AP	AP	AP	GS	GS	GS	GS	
	C					AP	AP	AP					
	B					AP	AP	AP					
	A					AP	AP	AP					
		4P + 12S + 4P											

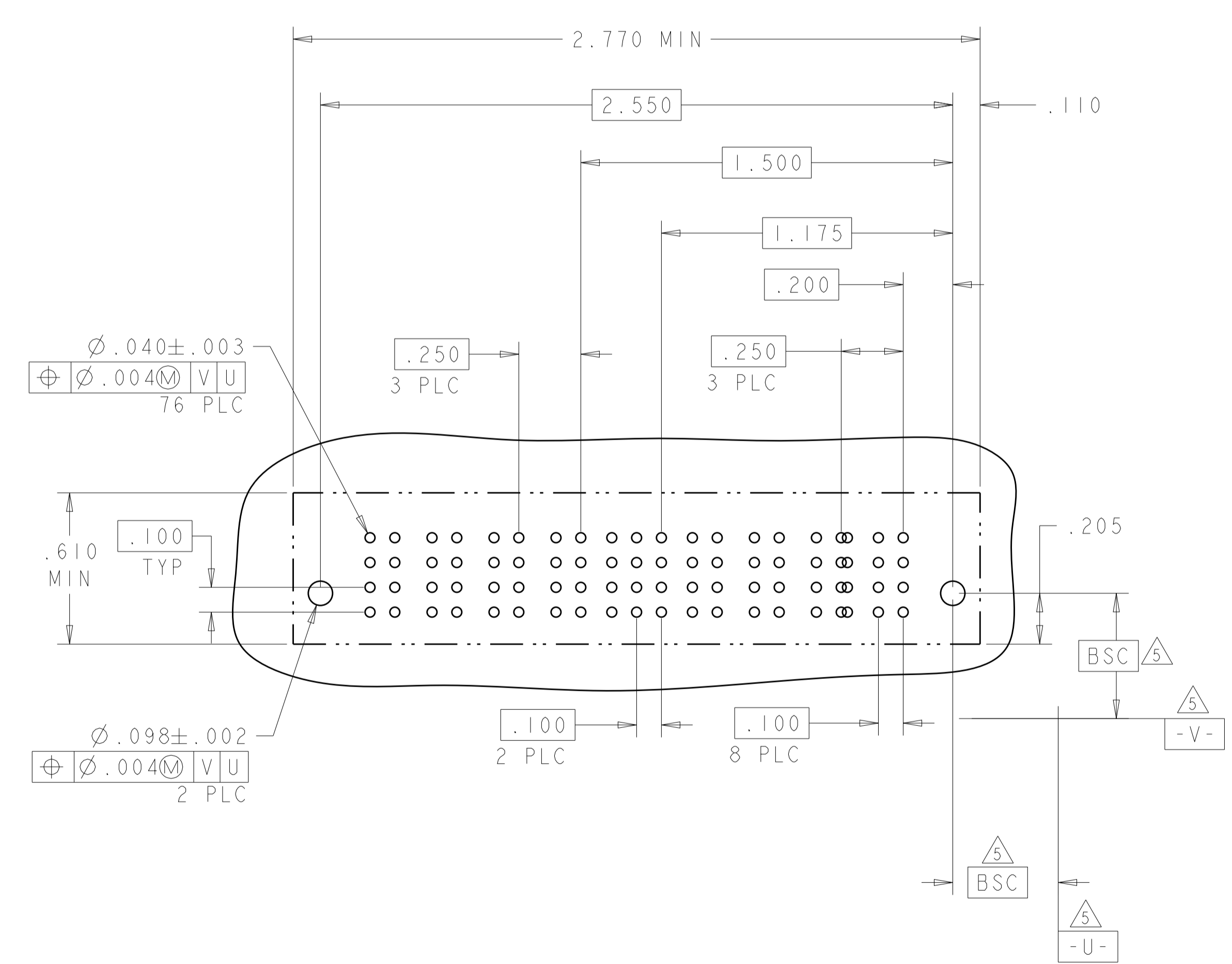
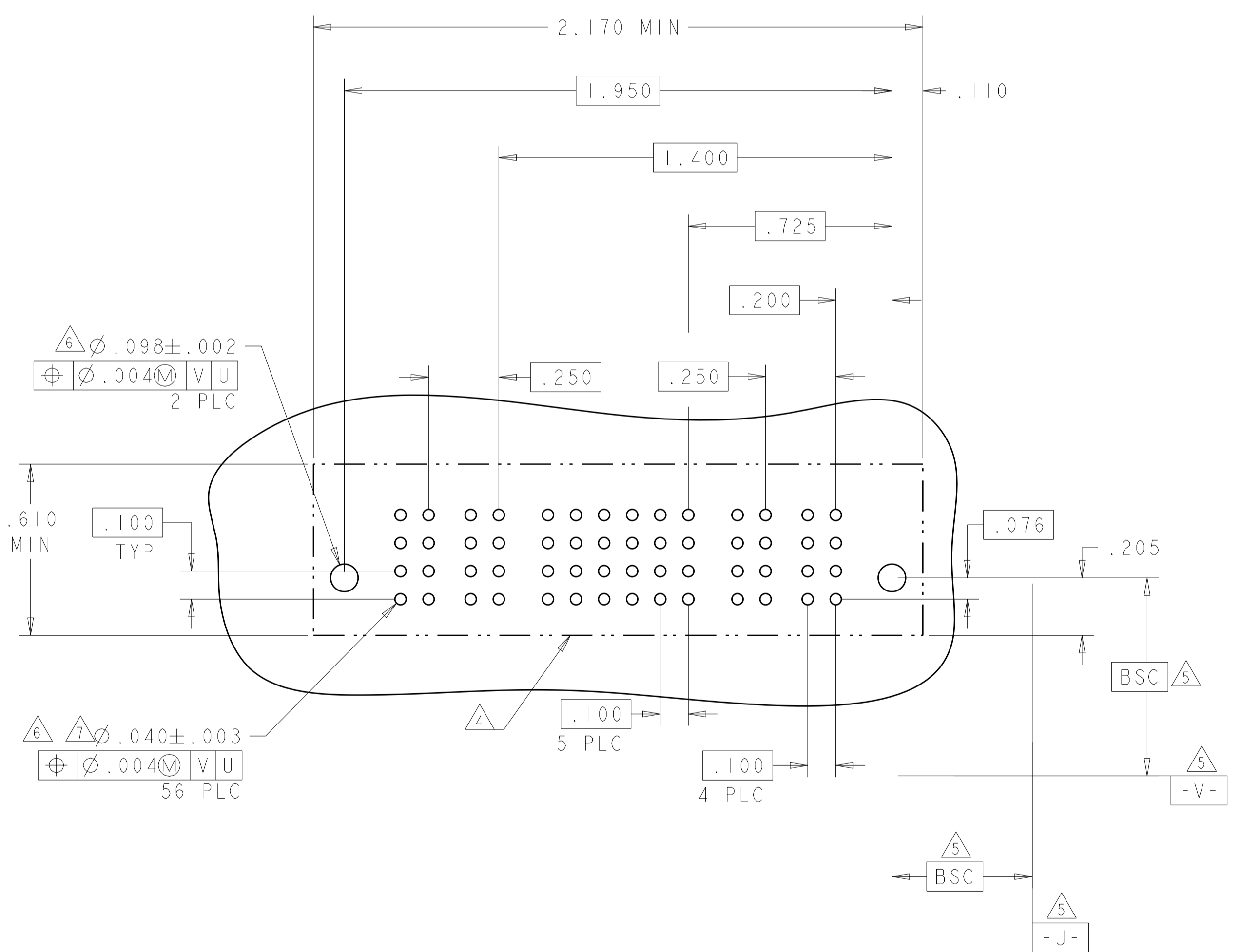

THIS DRAWING IS A CONTROLLED DOCUMENT.

DWN: D. ZHU	20DEC2007	TE Connectivity VER RECEP ASSEMBLY SHORT GUIDES, PRESS FIT MULTI-BEAM XLE
CHK: S. ZHAO	20DEC2007	
APVD: S. ZHAO	-	
NAME: S. ZHAO	-	
DIMENSIONS: INCHES	TOLERANCES UNLESS OTHERWISE SPECIFIED:	PRODUCT SPEC
0 PLC ± .01	1 PLC ± .01	108-2292
2 PLC ± .01	2 PLC ± .01	APPLICATION SPEC
3 PLC ± .005	3 PLC ± .005	114-13251
4 PLC ± .0020	4 PLC ± .0020	WEIGHT
ANGLES ± .2°	ANGLES ± .2°	FINISH
MATERIAL	FINISH	CUSTOMER DRAWING

SIZE: A100779 CAGE CODE: 6450860 DRAWING NO: 114-13251 SHEET 14 OF 28 REV: K2

LOC	DIST	REVISIONS			
		REV	DATE	BY	APPV
ES	00	-	-	-	-
		SEE SHEET 1			

G4

PART NUMBER	ROWS	POWER				SIGNAL																POWER						
		P8	P7	P6	P5	15	14	13	12	11	10	9	8	7	6	5	4	3	2	1	P4	P3	P2	P1				
3-6450860-1	D	LSI	LSI	LSI	LSI	AP	AP	AP	AP	AP	AP	AP	AP	AP	AP	AP	AP	AP	AP	AP	AP	AP	LSI	LSI	LSI	LSI		
	C					AP	AP	AP	AP	AP	AP	AP	AP	AP	AP	AP	AP	AP	AP	AP	AP	AP	AP	LSI	LSI	LSI	LSI	
	B					AP	AP	AP	AP	AP	AP	AP	AP	AP	AP	AP	AP	AP	AP	AP	AP	AP	AP	AP	LSI	LSI	LSI	LSI
	A					AP	AP	AP	AP	AP	AP	AP	AP	AP	AP	AP	AP	AP	AP	AP	AP	AP	AP	AP	LSI	LSI	LSI	LSI
4LP + 60S + 4LP																												



THIS DRAWING IS A CONTROLLED DOCUMENT.		OWN: D. ZHU	20DEC2007	TE Connectivity
DIMENSIONS: INCHES		CHK: S. ZHAO	20DEC2007	
DIMENSIONS: INCHES TOLERANCES UNLESS OTHERWISE SPECIFIED: 0 PLC ±. 1 PLC ±.01 2 PLC ±.01 3 PLC ±.005 4 PLC ±.0020 ANGLES ±.2°		APVD: S. ZHAO		NAME: VER RECEP ASSEMBLY SHORT GUIDES, PRESS FIT MULTI-BEAM XLE
MATERIAL: -		PRODUCT SPEC: 108-2292	APPLICATION SPEC: 114-13251	SIZE: A1 CAGE CODE: 00779 DRAWING NO: 6450860
FINISH: -		WEIGHT: -	CUSTOMER DRAWING	RESTRICTED TO: - SCALE: N/A SHEET: 18 OF 28 REV: K2

LOC	DIST	REV	DATE	BY	APPV
ES	00				
		REVISIONS			
		DESCRIPTION	DATE	BY	APPV
		SEE SHEET 1			



3-6450860-2

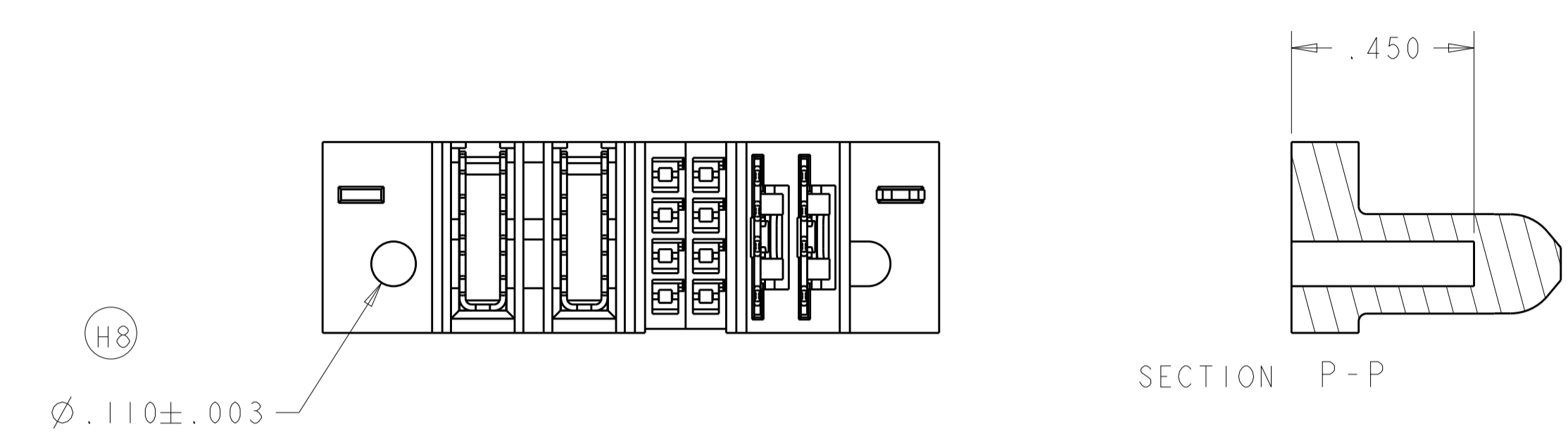

3-6450860-3

PART NUMBER	ROWS	POWER		SIGNAL				POWER	
		P4	P3	3	2	1	2	P2	P1
3-6450860-2	D C B A	GS	GS	AP	AP	AP	AP	GS	GS
		2P + 16S + 2P							

PART NUMBER	ROWS	POWER		SIGNAL		POWER	
		P4	P3	2	1	P2	P1
3-6450860-3	D C B A	GS	GS	AP	AP	LSI	LSI
		2LP + 8S + 2P					

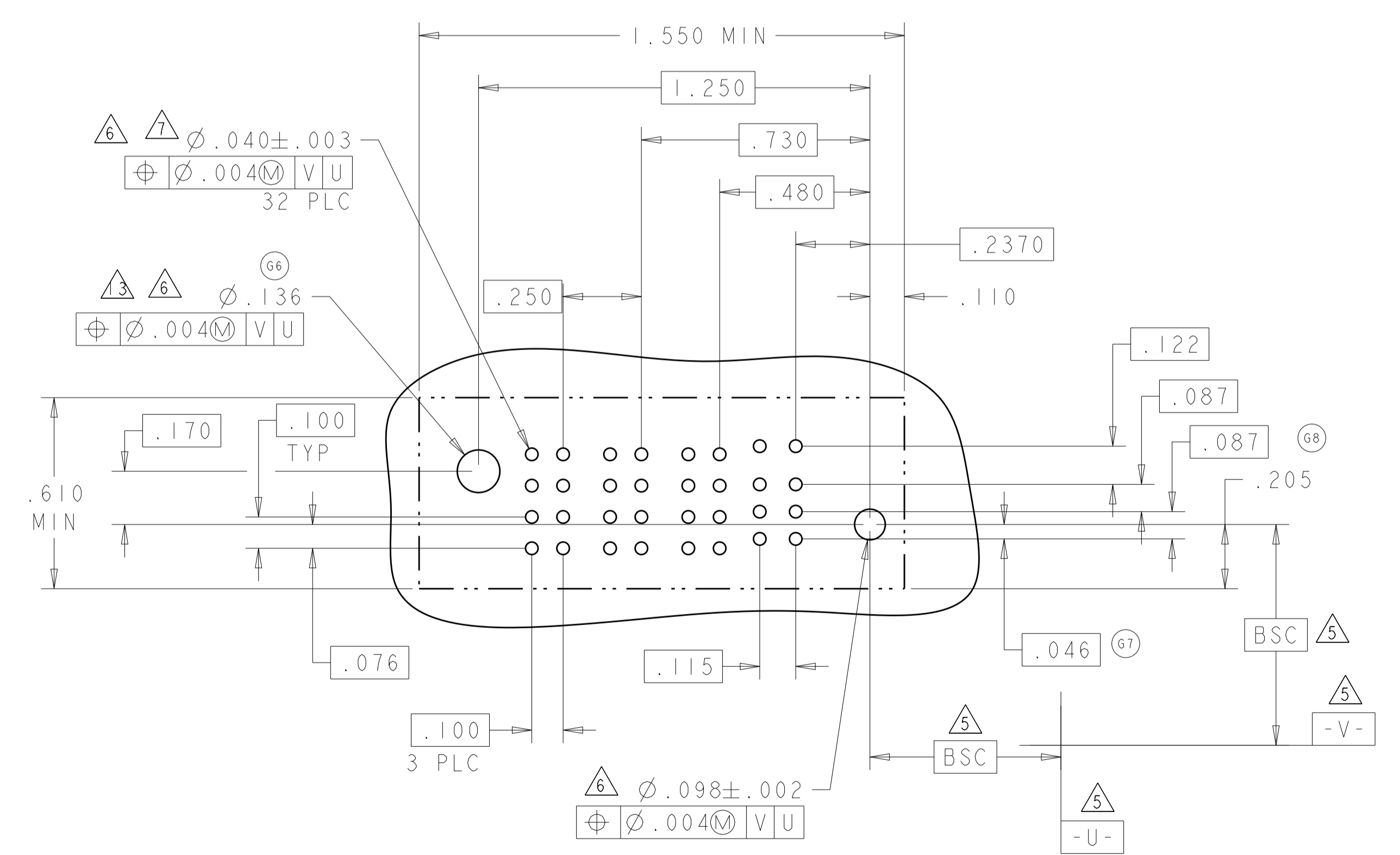
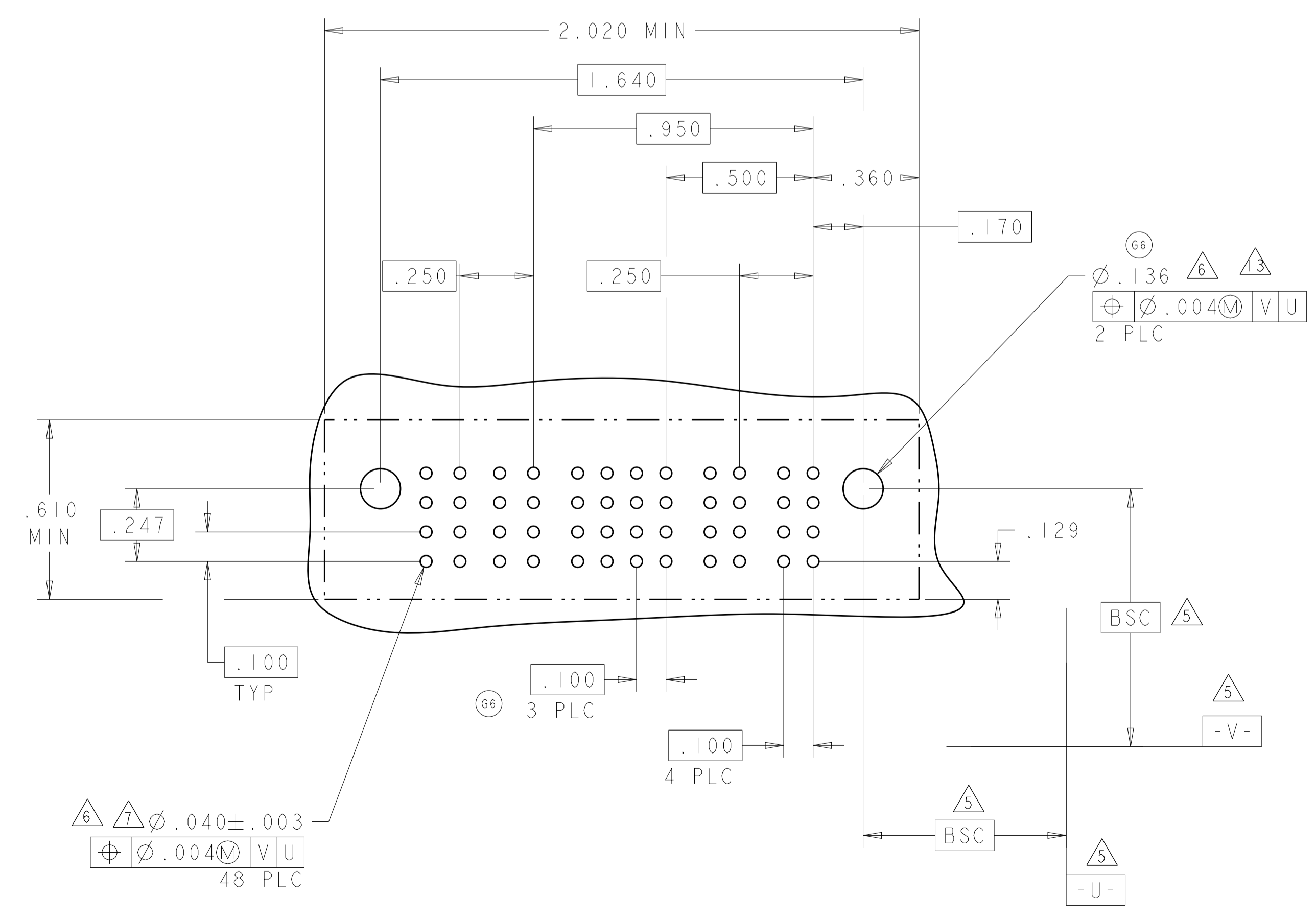

THIS DRAWING IS A CONTROLLED DOCUMENT.

DIMENSIONS:	TOLERANCES UNLESS OTHERWISE SPECIFIED:	DRN: D. ZHU	20DEC2007	
INCHES	0 PLC ± .01 1 PLC ± .01 2 PLC ± .01 3 PLC ± .005 4 PLC ± .002 ANGLES ± .020	CHK: S. ZHAO	20DEC2007	
MATERIAL:	FINISH:	APVD: S. ZHAO	NAME:	VER RECEPT ASSEMBLY SHORT GUIDES, PRESS FIT MULTI-BEAM XLE
		PRODUCT SPEC: 108-2292	SIZE: A1	CAGE CODE: 6450860 DRAWING NO: 114-13251 SCALE: N/A SHEET 19 OF 28 REV: K2
		APPLICATION SPEC: 114-13251	CUSTOMER DRAWING	

LOC	DIST	REVISIONS			
		REV	DATE	BY	APPV
ES	00	-	SEE SHEET 1	-	-

PART NUMBER	ROWS	POWER						SIGNAL						POWER					
		P12	P11	P10	P9	P8	P7	6	5	4	3	2	1	P6	P5	P4	P3	P2	P1
3-6450860-5	D							AP	AP	AP	AP	AP	AP						
	C							AP	AP	AP	AP	AP	AP						
	B	GS	GS	GS	GS	GS	GS	AP	AP	AP	AP	AP	AP	GS	GS	GS	GS	GS	GS
	A	HD						AP	AP	AP	AP	AP	AP						
6P + 24S + 6P																			

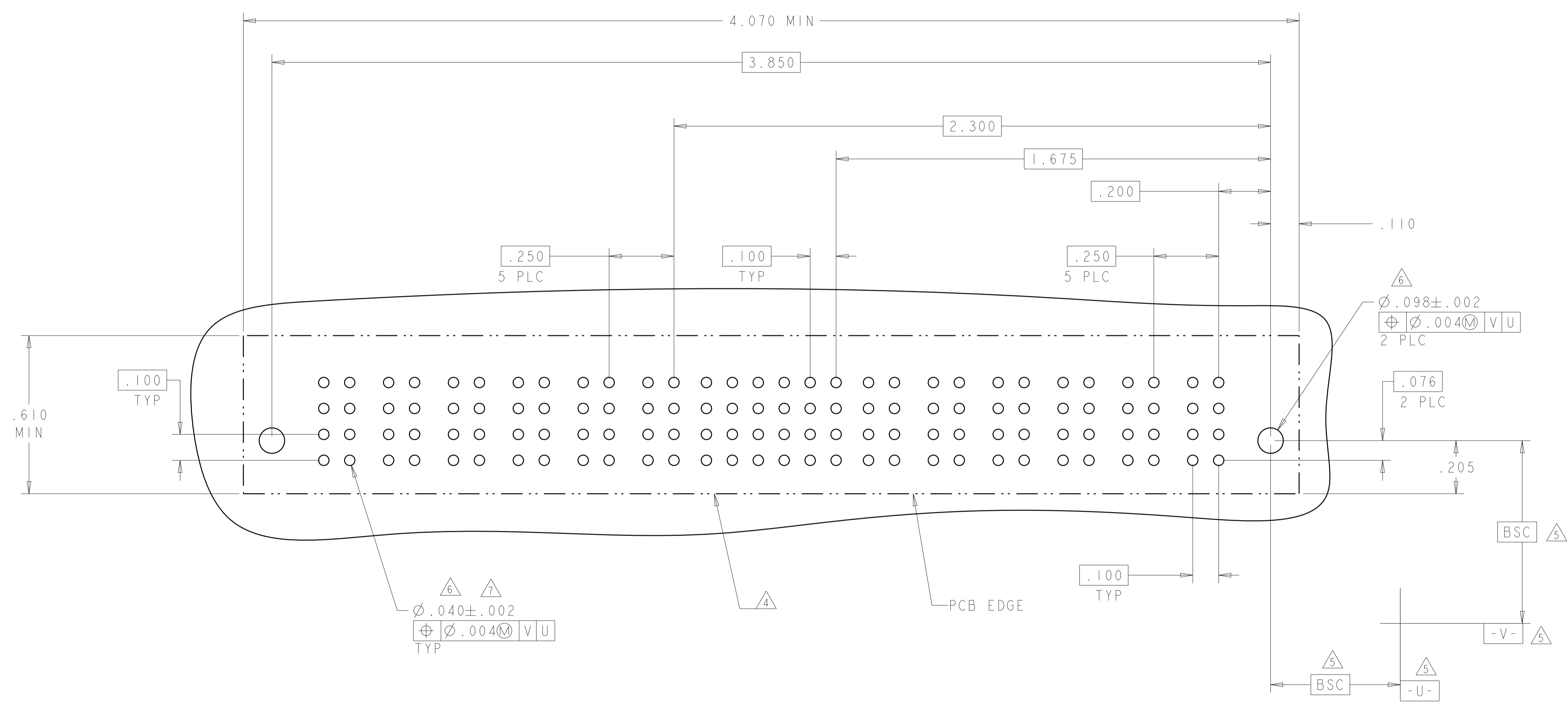

THIS DRAWING IS A CONTROLLED DOCUMENT.		OWN: D. ZHU	ZODEC2007	TE Connectivity
DIMENSIONS: INCHES		CHK: S. ZHAO	ZODEC2007	
TOLERANCES UNLESS OTHERWISE SPECIFIED: 0 PLC ±. 1 PLC ±.01 2 PLC ±.01 3 PLC ±.005 4 PLC ±.0020 ANGLES ±.7°		APVD: S. ZHAO	-	NAME: VER RECEP ASSEMBLY SHORT GUIDES, PRESS FIT MULTI-BEAM XLE
MATERIAL: -		FINISH: -	WEIGHT: -	RESTRICTED TO: -
CUSTOMER DRAWING		SCALE: N/A	SHEET 20 OF 28	REV: K2

LOC	DIST	REV	DATE	BY	APPV
ES	00				

REVISIONS		DATE	BY	APPV
1	SEE SHEET 1			

PART NUMBER	ROWS	POWER			SIGNAL		POWER	
		P5	P4	P3	2	1	P2	P1
3-6450860-4	D	LSI	LSI	LSI	AP	AP	LSI	LSI
	C				AP	AP		
	B				AP	AP		
	A				AP	AP		

2LP + 8S + 3LP

G3

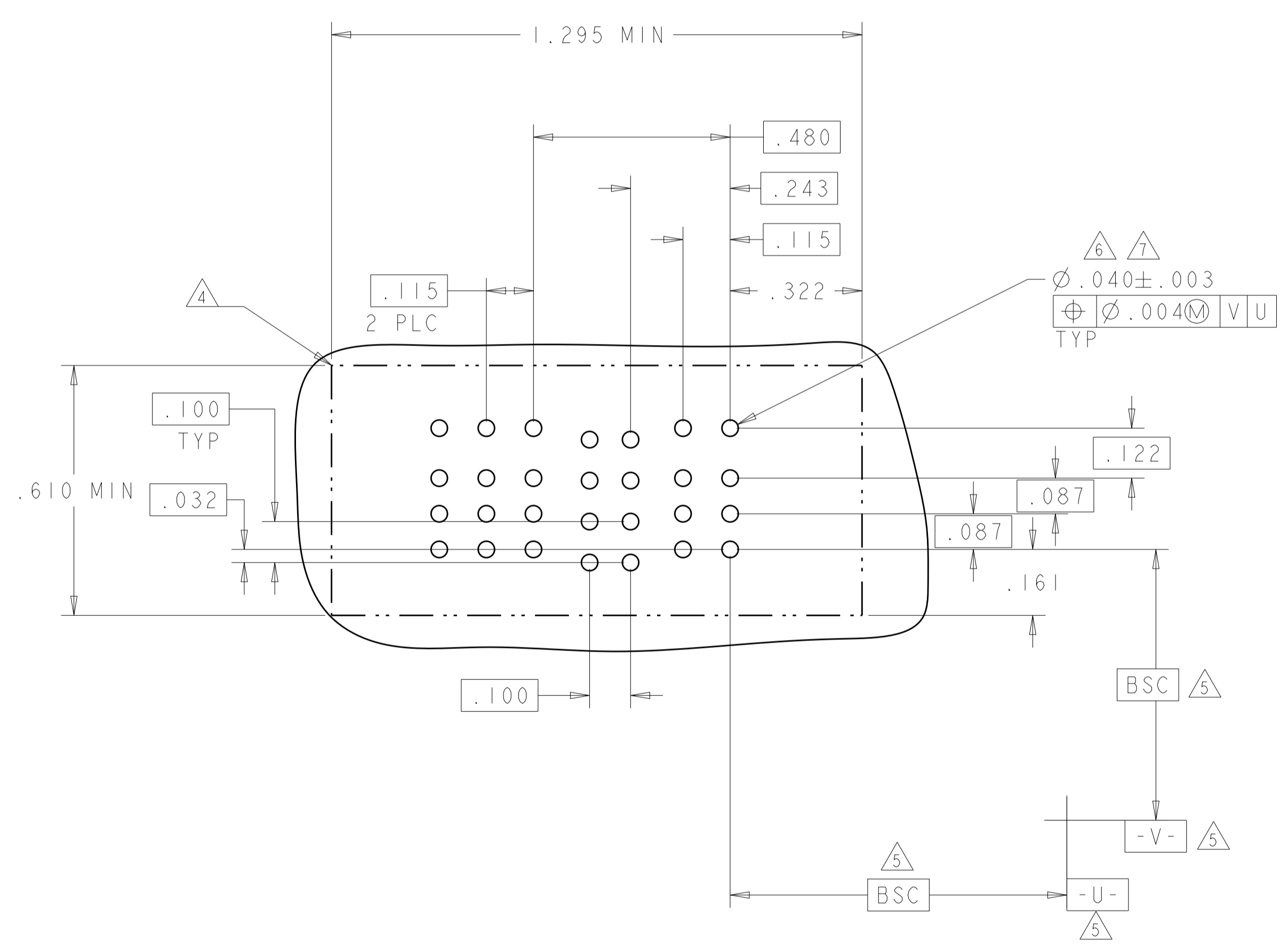

PART NUMBER	ROWS	POWER		SIGNAL												POWER		
		P4	P3	12	11	10	9	8	7	6	5	4	3	2	1	P2	P1	
3-6450860-6	D	GS	GS	AP	AP	AP	AP	AP	AP	AP	AP	AP	AP	AP	AP	AP	AP	AP
	C			AP	AP	AP	AP	AP	AP	AP	AP	AP	AP	AP	AP	AP	AP	AP
	A			AP	AP	AP	AP	AP	AP	AP	AP	AP	AP	AP	AP	AP	AP	AP

2P + 48S + 2P



THIS DRAWING IS A CONTROLLED DOCUMENT.		OWN: D. ZHU	20DEC2007	 TE Connectivity
DIMENSIONS: INCHES		CHK: S. ZHAO	20DEC2007	
TOLERANCES UNLESS OTHERWISE SPECIFIED:		APVD: S. ZHAO		VER RECEP ASSEMBLY SHORT GUIDES, PRESS FIT MULTI-BEAM XLE
0 PLC ±		PRODUCT SPEC		
1 PLC ±.01		APPLICATION SPEC	108-2292	
2 PLC ±.005		APPLIC. SPEC	114-13251	
3 PLC ±.0020		WEIGHT		A100779C=6450860
4 PLC ±.0020		CUSTOMER DRAWING		
ANGLES ±.7°		SCALE	N/A	SHEET 21 OF 28 REV K2
FINISH				

LOC		DIST		REVISIONS			
ES	00	P	LTN	DESCRIPTION	DATE	DMN	APVD
		-		SEE SHEET 1			

PART NUMBER	ROWS		POWER			SIGNAL				POWER					
			PI	3	2	1	LP4	LP3	LP2	LP1					
3-6450860-9	D C B A	GS	AP	AP	AP										
			AP	AP	AP										
			AP	AP	AP										
			AP	AP	AP										
4LP + 12S + 1P															

PART NUMBER	ROWS		POWER		SIGNAL						POWER			
			P2	P1	6	5	4	3	2	1	PI			
4-6450860-0	D C B A	GS	AP	AP	AP	AP	AP	AP	AP	AP	AP	AP	AP	AP
			AP	AP	AP	AP	AP	AP	AP	AP	AP	AP	AP	AP
			AP	AP	AP	AP	AP	AP	AP	AP	AP	AP	AP	AP
			AP	AP	AP	AP	AP	AP	AP	AP	AP	AP	AP	AP
IP + 24S + 1P														

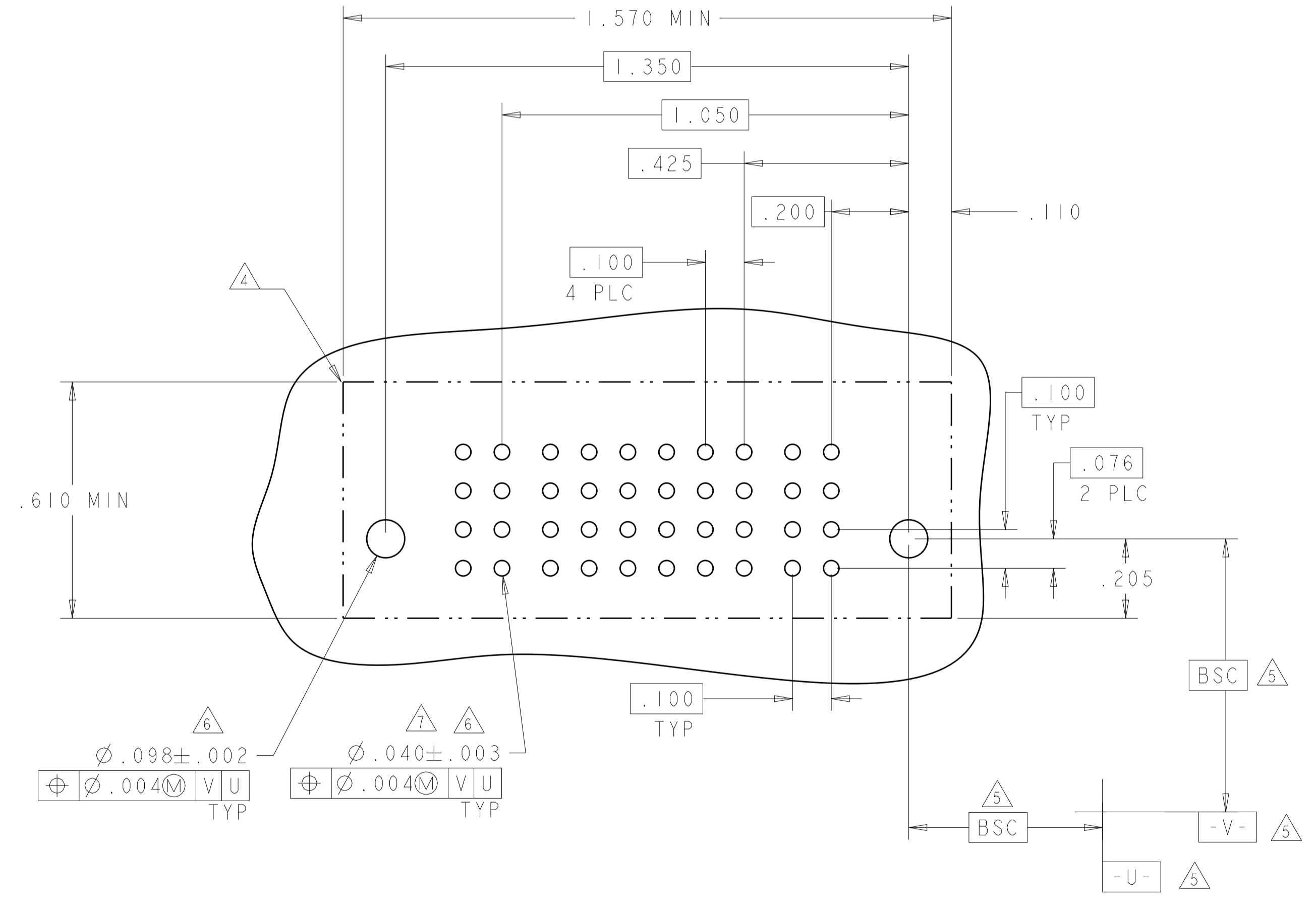

THIS DRAWING IS A CONTROLLED DOCUMENT.

DIMENSIONS:	TOLERANCES UNLESS OTHERWISE SPECIFIED:	DMN: D. ZHU	ZODEC2007	 TE Connectivity
INCHES	0 PLC ±.01 1 PLC ±.01 2 PLC ±.01 3 PLC ±.005 4 PLC ±.002 ANGLES ±.020	CHK: S. ZHAO	ZODEC2007	
MATERIAL:	FINISH:	APVD: S. ZHAO	NAME:	VER RECEPT ASSEMBLY SHORT GUIDES, PRESS FIT MULTI-BEAM XLE
		PRODUCT SPEC: 108-2292	APPLICATION SPEC: 114-13251	SIZE: A
		WEIGHT:	CAGE CODE: 6450860	RESTRICTED TO:
		CUSTOMER DRAWING	SCALE: N/A	SHEET 22 OF 28

LOC	DIST	REVISIONS			
P	LTN	DESCRIPTION	DATE	DWN	APVD
ES	00	SEE SHEET 1	-	-	-



4-6450860-2

PART NUMBER	ROWS	POWER		SIGNAL		POWER	
		P4	P3	2	1	P2	P1
4-6450860-2	D C B A	GS	GP	AP	AP	LSI	LSI
2LP + 8S + 2P						HD	



RECOMMENDED PCB LAYOUT

THIS DRAWING IS A CONTROLLED DOCUMENT.		DWN: D. ZHU CHK: S. ZHAO	20DEC2007	TE Connectivity VER RECEP ASSEMBLY SHORT GUIDES, PRESS FIT MULTI-BEAM XLE
DIMENSIONS: INCHES		APVD: S. ZHAO	NAME: VER RECEP ASSEMBLY	
TOLERANCES UNLESS OTHERWISE SPECIFIED: 0 PLC ± 1 PLC ±.01 2 PLC ±.01 3 PLC ±.005 4 PLC ±.0020 ANGLES ±.2°		PRODUCT SPEC: 108-2292	APPLICATION SPEC: 114-13251	RESTRICTED TO: -
MATERIAL: -		FINISH: -	WEIGHT: -	SCALE: N/A
CUSTOMER DRAWING		SIZE: A1		SHEET 24 OF 28

LOC		DIST		REVISIONS			
ES	00	P	LTN	DESCRIPTION	DATE	DWN	APVD
		-		SEE SHEET 1			

PART NUMBER	ROWS	POWER								SIGNAL		POWER							
		P16	P15	P14	P13	P12	P11	P10	P9	2	1	P8	P7	P6	P5	P4	P3	P2	P1
4-6450860-4	D C B A	GS	GS	GS	GS	GS	GS	GS	GS	AP	AP	GS	GS	GS	GS	GS	GS	GS	GS
8P + 8S + 8P																			

J2

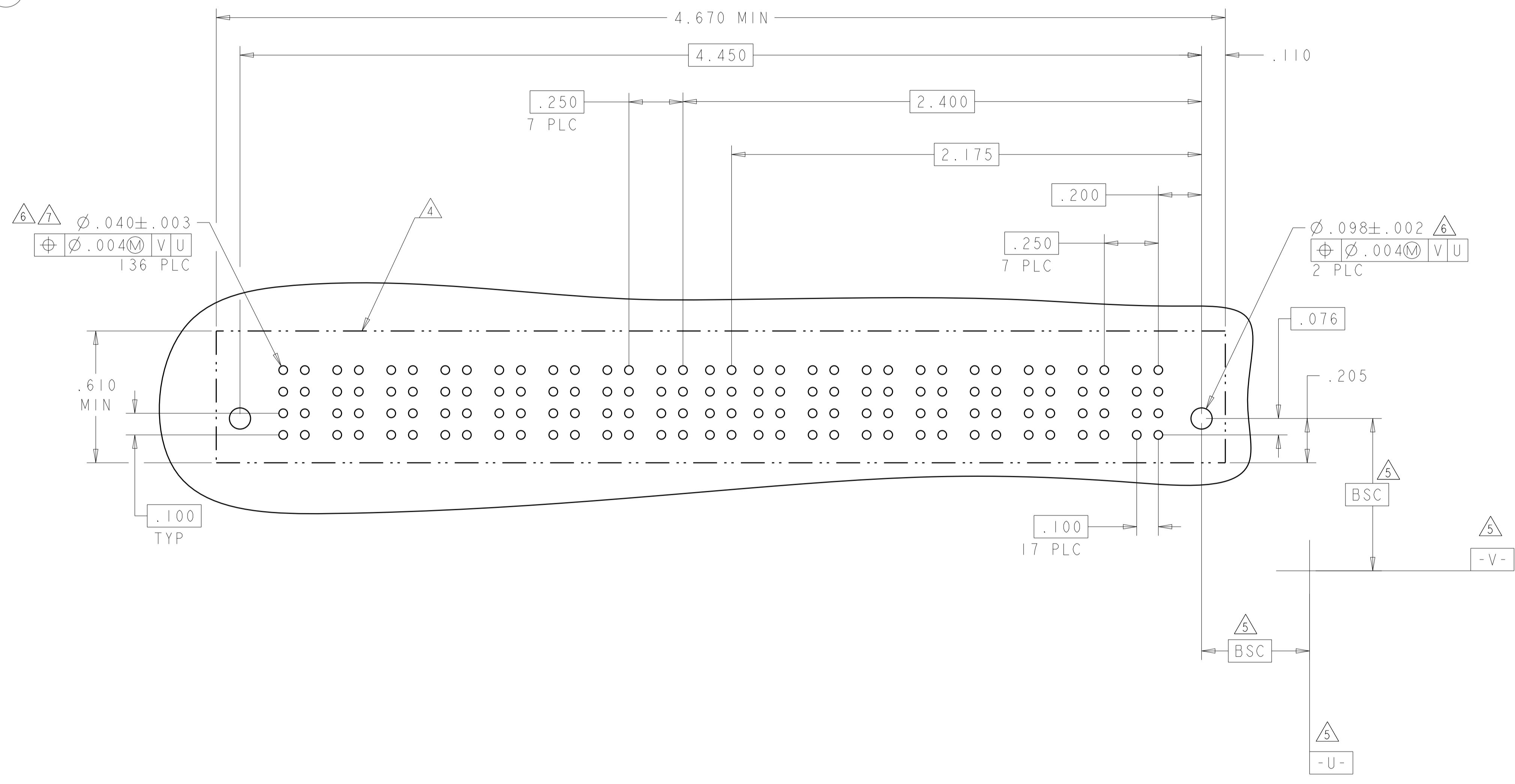

THIS DRAWING IS A CONTROLLED DOCUMENT.		DWN D. ZHU	Z0DEC2007	 TE Connectivity
DIMENSIONS: INCHES		CHK S. ZHAO	Z0DEC2007	
TOLERANCES UNLESS OTHERWISE SPECIFIED:		APVD S. ZHAO		NAME VER RECEP ASSEMBLY SHORT GUIDES, PRESS FIT MULTI-BEAM XLE
0 PLC ±. 1 PLC ±.01 2 PLC ±.01 3 PLC ±.005 4 PLC ±.0020 ANGLES ±.2°		PRODUCT SPEC 108-2292		SIZE 114-13251
MATERIAL		APPLICATION SPEC		RESTRICTED TO
FINISH		WEIGHT		A100779C=6450860
		CUSTOMER DRAWING	SCALE N/A	SHEET 25 OF 28 REV K2

LOC		DIST		REVISIONS			
ES	00	P	LTN	DESCRIPTION	DATE	DMN	APVD
		-		SEE SHEET 1			

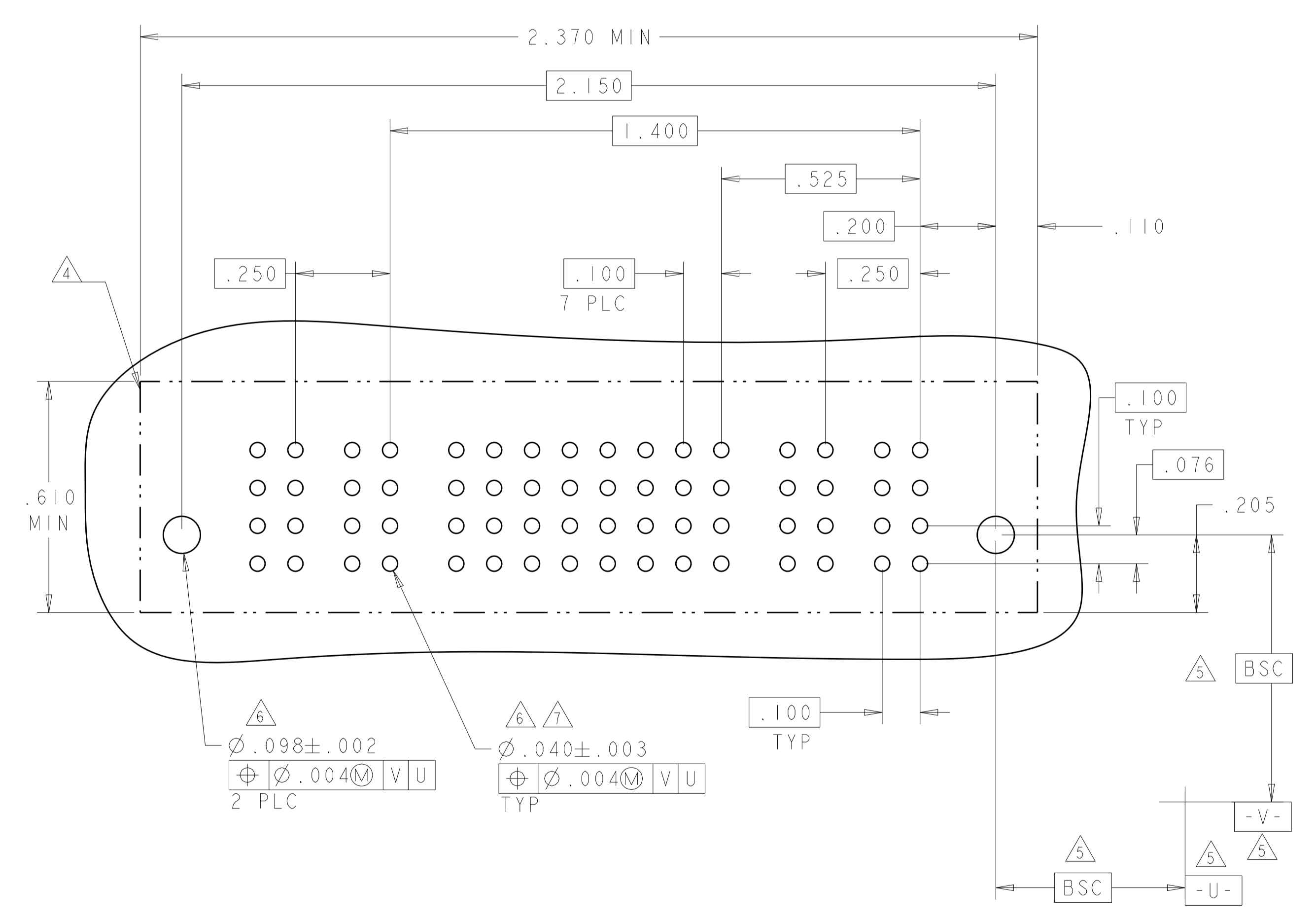
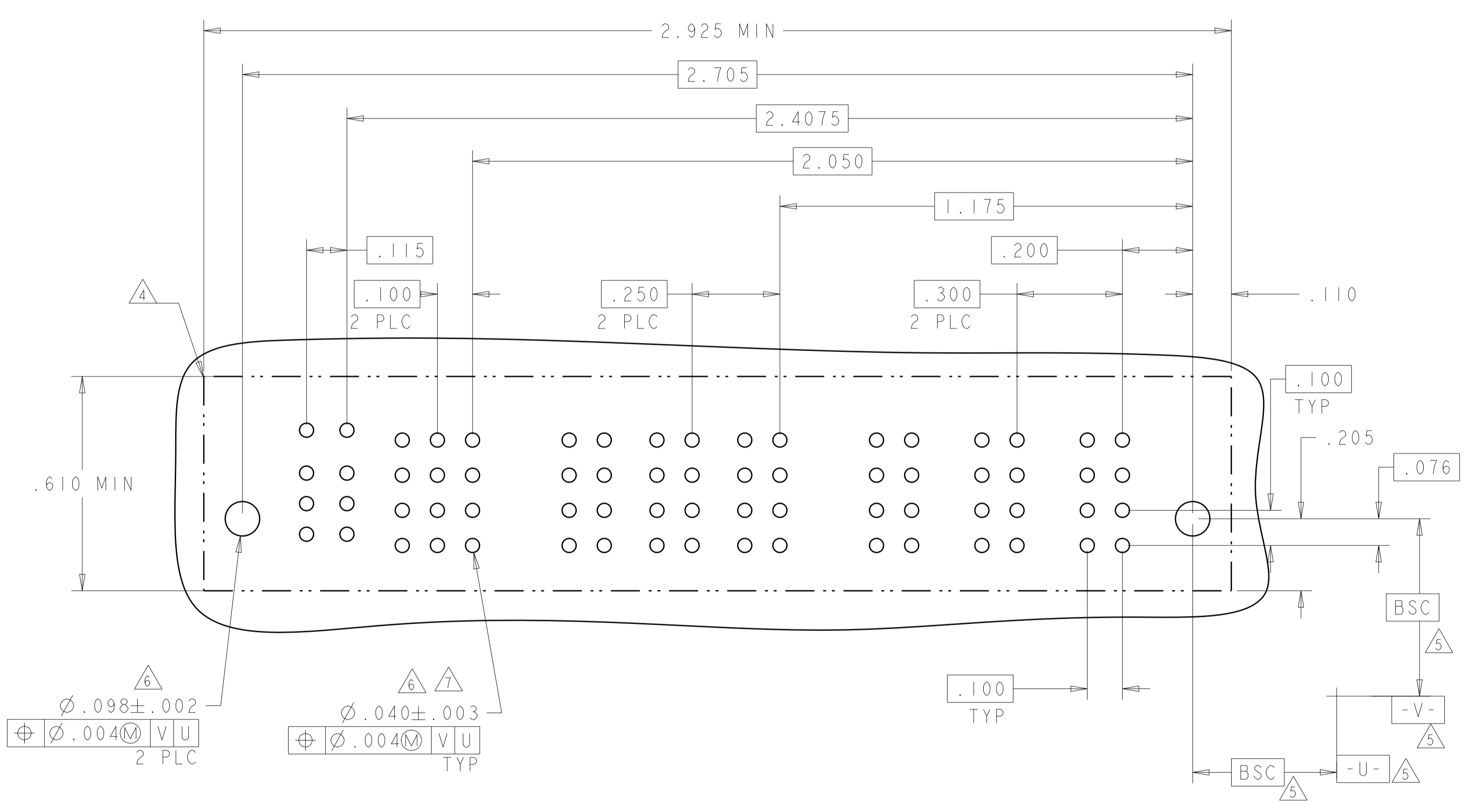

THIS DRAWING IS A CONTROLLED DOCUMENT.

DIMENSIONS:	TOLERANCES UNLESS OTHERWISE SPECIFIED:	DMN: D. ZHU	20DEC2007	TE Connectivity
INCHES	0 PLC ±.01 1 PLC ±.01 2 PLC ±.01 3 PLC ±.005 4 PLC ±.002 ANGLES ±.020	CHK: S. ZHAO	20DEC2007	
MATERIAL:	FINISH:	APVD: S. ZHAO	NAME:	VER RECEPT ASSEMBLY SHORT GUIDES, PRESS FIT MULTI-BEAM XLE
		PRODUCT SPEC: 108-2292	APPLICATION SPEC: 114-13251	SIZE: A1
		WEIGHT:	CAGE CODE: 6450860	RESTRICTED TO:
		CUSTOMER DRAWING	SCALE: N/A	SHEET 26 OF 28 REV: K2

LOC	DIST	REVISIONS			
P	LTN	DESCRIPTION	DATE	OWN	APVD
-	-	SEE SHEET 1	-	-	-

PART NUMBER	ROWS	POWER				SIGNAL					POWER				
		P8	P7	P6	P5	6	5	4	3	2	1	P4	P3	P2	P1
4-6450860-7	D	GS	GS	GS	GS	AP	AP	AP	AP	AP	AP	GS	GS	GS	GS
	C					AP	AP	AP	AP	AP					
	B					AP	AP	AP	AP	AP					
	A					AP	AP	AP	AP	AP					

4P + 24S + 4P

PART NUMBER	ROWS	LOW POWER		SIGNAL				LOW POWER	
		P4	P3	4	3	2	1	P2	P1
4-6450860-8	D	LS1	LS1	AP	AP	AP	AP	LS1	LS1
	C			AP	AP	AP	AP		
	B			AP	AP	AP	AP		
	A			AP	AP	AP	AP		

2LP + 16S + 2LP

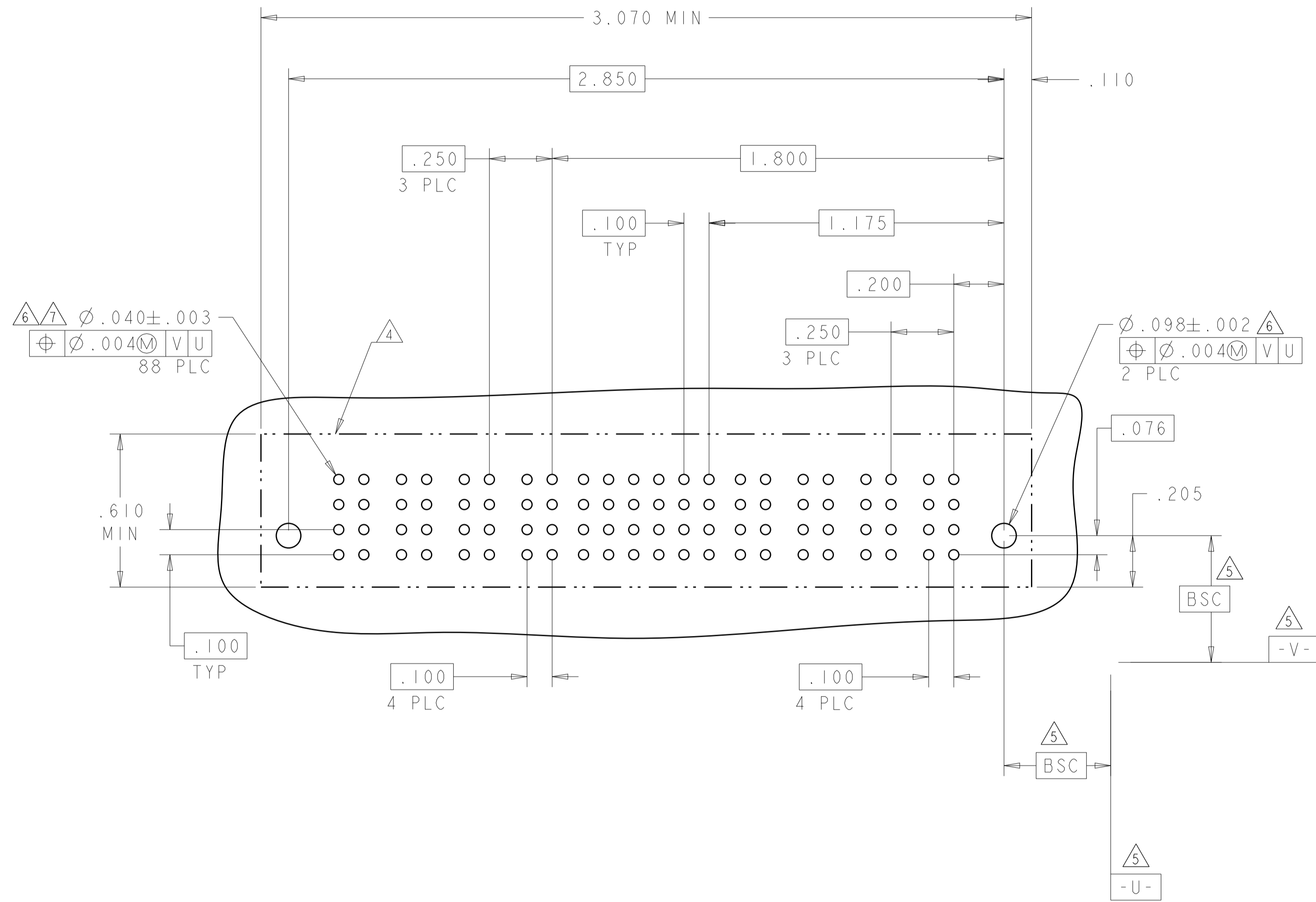

J9

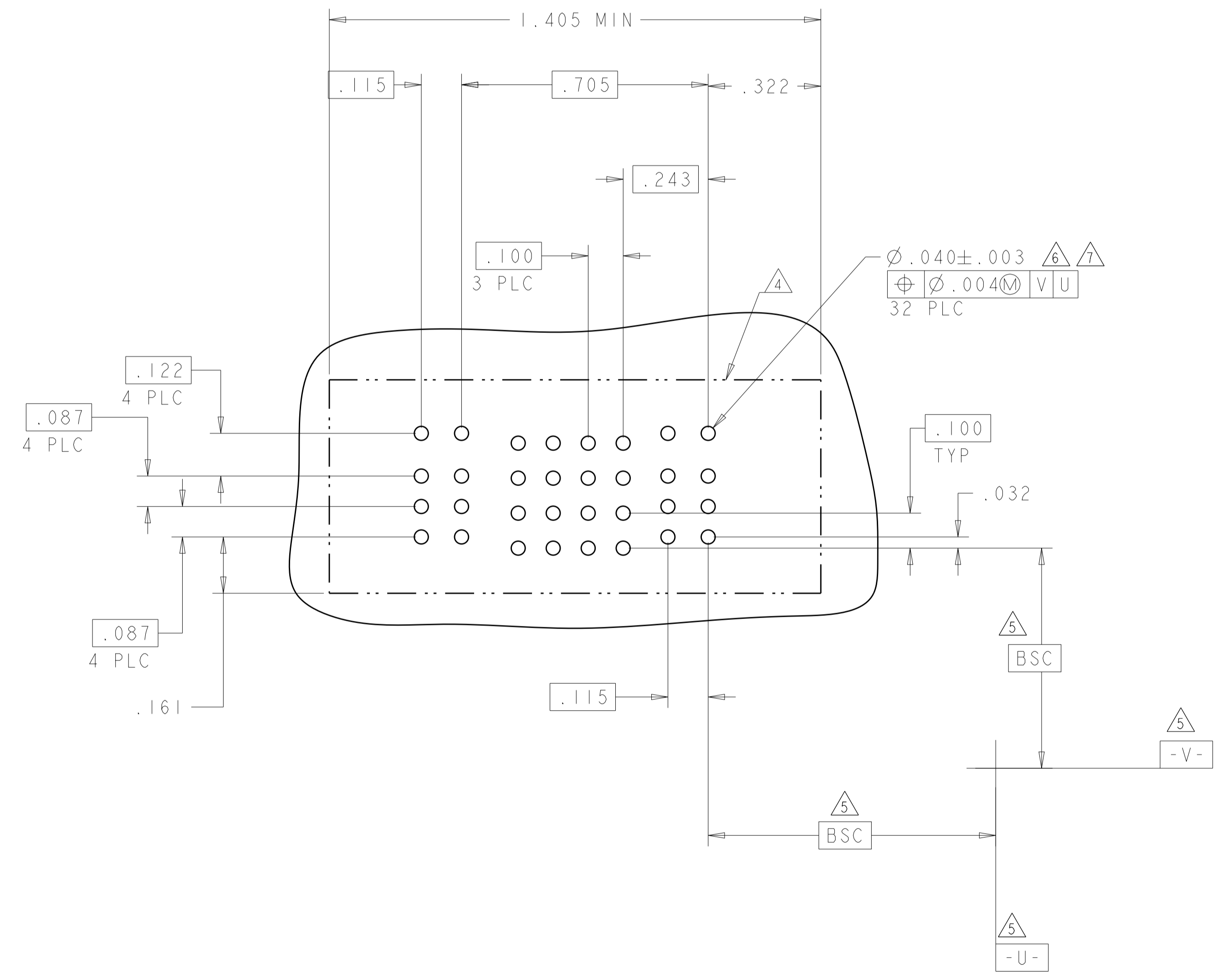

THIS DRAWING IS A CONTROLLED DOCUMENT.		OWN: D. ZHU	20DEC2007	 TE Connectivity
DIMENSIONS: INCHES		CHK: S. ZHAO	20DEC2007	
TOLERANCES UNLESS OTHERWISE SPECIFIED:		APVD: S. ZHAO		NAME: VER RECEPT ASSEMBLY SHORT GUIDES, PRESS FIT MULTI-BEAM XLE
0 PLC ±.01		PRODUCT SPEC		SIZE: CAGE CODE DRAWING NO
1 PLC ±.01		APPLICATION SPEC		RESTRICTED TO
2 PLC ±.01		114-13251		A100779C=6450860
3 PLC ±.005		WEIGHT		SCALE: N/A SHEET 27 OF 28 REV: K2
4 PLC ±.0020		CUSTOMER DRAWING		
ANGLES ±.020				
FINISH				

LOC	DIST	REVISIONS			
P	LTN	DESCRIPTION	DATE	DWN	APVD
-	-	SEE SHEET 1	-	-	-

PART NUMBER	ROWS	POWER		SIGNAL						POWER			
		P4	P3	6	5	4	3	2	1	P2	P1		
5-6450860-2	D	GS	GS	AP	AP	AP	AP	AP	AP	AP	GS	GS	HD
	C			AP	AP	AP	AP	AP	AP				
	B			AP	AP	AP	AP	AP	AP				
	A			AP	AP	AP	AP	AP	AP				
2P + 24S + 2P													



THIS DRAWING IS A CONTROLLED DOCUMENT.		DWN: D. ZHU CHK: S. ZHAO APVD: S. ZHAO	Z0DEC2007 Z0DEC2007	 TE Connectivity
DIMENSIONS: INCHES	TOLERANCES UNLESS OTHERWISE SPECIFIED:	PRODUCT SPEC: 108-2292 APPLICATION SPEC: 114-13251 WEIGHT: - CUSTOMER DRAWING		
0 PLC ±. 1 PLC ±.01 2 PLC ±.01 3 PLC ±.005 4 PLC ±.0020 ANGLES ±.2° FINISH: -	NAME: VER RECEP ASSEMBLY SHORT GUIDES, PRESS FIT MULTI-BEAM XLE SIZE: A1 CAGE CODE: 100779 DRAWING NO: C=6450860 SCALE: N/A SHEET: 28 OF 28 REV: K2			RESTRICTED TO: -



Компания «ЭлектроПласт» предлагает заключение долгосрочных отношений при поставках импортных электронных компонентов на взаимовыгодных условиях!

Наши преимущества:

- Оперативные поставки широкого спектра электронных компонентов отечественного и импортного производства напрямую от производителей и с крупнейших мировых складов;
- Поставка более 17-ти миллионов наименований электронных компонентов;
- Поставка сложных, дефицитных, либо снятых с производства позиций;
- Оперативные сроки поставки под заказ (от 5 рабочих дней);
- Экспресс доставка в любую точку России;
- Техническая поддержка проекта, помощь в подборе аналогов, поставка прототипов;
- Система менеджмента качества сертифицирована по Международному стандарту ISO 9001;
- Лицензия ФСБ на осуществление работ с использованием сведений, составляющих государственную тайну;
- Поставка специализированных компонентов (Xilinx, Altera, Analog Devices, Intersil, Interpoint, Microsemi, Aeroflex, Peregrine, Syfer, Eurofarad, Texas Instrument, Miteq, Cobham, E2V, MA-COM, Hittite, Mini-Circuits, General Dynamics и др.);

Помимо этого, одним из направлений компании «ЭлектроПласт» является направление «Источники питания». Мы предлагаем Вам помощь Конструкторского отдела:

- Подбор оптимального решения, техническое обоснование при выборе компонента;
- Подбор аналогов;
- Консультации по применению компонента;
- Поставка образцов и прототипов;
- Техническая поддержка проекта;
- Защита от снятия компонента с производства.



Как с нами связаться

Телефон: 8 (812) 309 58 32 (многоканальный)

Факс: 8 (812) 320-02-42

Электронная почта: org@eplast1.ru

Адрес: 198099, г. Санкт-Петербург, ул. Калинина, дом 2, корпус 4, литера А.