



MICRO SWITCH™
Subminiature Basic Switches
ZX Series



MICRO SWITCH™ ZX Series

Subminiature Basic Switches

Honeywell's MICRO SWITCH™ ZX Series is a subminiature snap-action switch from the family of Z series subminiature basic switches. Although small in size, the ZX Series is rated for controlling electrical loads ranging from logic-level/computer-based circuits to limited power-duty switching (up to 3 A/125 Vac). The ZX subminiature switch package is available with either solder terminals or a variety of different styles of printed circuit board (PCB) terminals to fulfill the requirements for electrical connectivity.

A wide variety of stainless steel levers are available and when combined with the subminiature package size, can adapt the ZX Series to a wide range of applications. To enhance the versatility of ZX switches, the family is certified to UL, cUL, ENEC, and CQC for worldwide use. The ZX Series is the right choice for a cost-effective subminiature switch package.

What makes our switches better?

- Designed to operate in a variety of applications
- Current carrying capacity, up to 3 A, allows for a solution in many applications where space is a premium
- Cost-effective switch in a compact package
- Subminiature switch package designed to meet a wide range of temperature requirements



RIGHT SWITCH FOR THE RIGHT APPLICATION
RELIABILITY • ELECTRICAL RATING

Features and Benefits

SMALL PACKAGE SIZE

Subminiature package size (6,5 mm x 12,8 mm [0.25 in x 0.50 in]) allows the MICRO SWITCH™ ZX Series switch to fit in applications where other sensors or switches are too large.

Enhanced performance in a compact package

WELL SUITED FOR POWER-DUTY AND LOGIC-LEVEL LOADS

ZX switch design helps assure control of limited **power-duty switching** with silver contacts or **logic-level** (low voltage, and milliamperes) with gold-plated contacts.

DESIGN FLEXIBILITY

Designed with a **pin plunger** for actuation, the ZX Series is also available with **various styles of levers**. The optional levers expand the versatility of the switch in the application. In addition, the ZX Series features a **variety of terminations** designed to provide flexibility for the electrical connectivity. Certified to **cUL, UL, ENEC, and CQC** for global applications, as well as RoHS compliant.

WORLDWIDE AVAILABILITY

Entire family of ZX switches is available worldwide through Honeywell's network.

Potential Applications



INDUSTRIAL

- Circuit breaker box module interlock
- Electric utility meter tamper switch
- Tamper switch for computer modules

COMMERCIAL

- Small residential appliances
- ATM equipment



MEDICAL

- Hospital bed pendant controls
- Infusion pumps (end of travel)
- Syringes (end of travel)



ZX Series

PRODUCT NOMENCLATURE

ZX	10	E	10	A	01	—
Switch Type	Current Rating	Operating Force ³ (at pin plunger)	Terminal Type	Actuator Type ⁴ (Levers Mounted Internal)	Circuitry	Special Designator ²
ZX Series	10 0.1 A 48 Vdc/125 Vac 0.2 A 60 Vdc gold-plated contacts	C 90 gf max.	10 Solder, straight	A Pin plunger	01 SPDT	A special designator is used to indicate non-standard features. This code consists of three alphanumeric characters max. A special designator is required when Terminal Type is "99" and/or Actuator Type is "S"
Subminiature			20 PCB (straight)	B Short straight lever (10 mm)		
Basic	40 1 A/3 A 125 Vac silver contacts	E 150 gf max.	30 PCB (snap-in)	C Standard straight lever (13 mm)		
Switch			50 PCB (right side)	E Sim. roller lever (11,8 mm, r 2,5 mm)		
			60 PCB (left side)	F Roller lever (10,7 mm, Ø 4,8 mm)		
			99 SPECIAL ²	G Sim. roller lever (10 mm, r 1,3 mm)		
				H Sim. roller lever (15 mm, r 1,3 mm)		
				J Long straight lever (30 mm)		
				S SPECIAL ²		

NOTES:

¹ Not all combinations of model code are available.

Please contact your Honeywell provider/representative for assistance.

² Actuator Type "99" and/or Actuator Type "S" designates a special and requires a special designator at the end of the listing.

³ Operating force is measured at the plunger. Adding an actuator/lever will change the operating force. See pages 6 and 7 for operating forces.

⁴ Lever length dimension is measured as follows: Straight lever - from center line of lever pivot to end of lever;

Roller and simulated roller lever - from center line of pivot to center of roller diameter. See page 8 for dimension details.

MICRO SWITCH™ Subminiature Basic Switches

Table 1. Specifications

Characteristic	ZX10 Series (Logic Level)	ZX40 Series (Power Duty)
Circuitry	SPDT	SPDT
Operating force	90 g or 150 g @ plunger	90 g or 150 g @ plunger
Termination	PCB, solder	PCB, solder
Sealing	internal live parts protected to IP40, IP00 due to exposed terminals	internal live parts protected to IP40, IP00 due to exposed terminals
Actuators (levers 300 series stainless steel)	pin plunger, short flat lever, standard flat lever, long flat lever, roller lever, short simulated roller lever, standard simulated roller lever, long sim. roller lever, special levers	pin plunger, short flat lever, standard flat lever, long flat lever, roller lever, short simulated roller lever, standard simulated roller lever, long sim. roller lever, special levers
Agency certification	UL, cUL, ENEC, CQC, RoHS compliant	UL, cUL, ENEC, CQC, RoHS complaint
Operating temperature (manufacturer rated)	-40 °C to 85 °C [-40 °F to 185 °F]	-40 °C to 85 °C [-40 °F to 185 °F]
Mechanical endurance (cycles)	3,000,000 min. @ 120 cycles/minute max.	3,000,000 min. @ 120 cycles/minute max.
Electrical endurance (cycles)	10,000 min. @ 30 cycles/minute max.	10,000 min. @ 30 cycles/minute max.
Switch resistance (initial)	100 mΩ max.	50 mΩ max.
Insulation resistance (initial)	100 MΩ min. (500 Vdc for one minute)	100 MΩ min. (500 Vdc for one minute)
Dielectric strength (initial) (between live parts and ground)	1500 VRMS for one minute ≤0.5 mA leakage current	1500 VRMS for one minute ≤0.5 mA leakage current
Contact material	gold-plated silver	silver
Housing material	case, polyamide (nylon); cover, polyamide (nylon)	case, polyamide (nylon); cover, polyamide (nylon)

Note: Refer to engineering drawing for additional information.

Table 2. Electrical Ratings

Switch Option	CQC (Asia-Pacific) Per GB 15092-1	ENEC (Europe) Per IEC 61058-1	UL, cUL (Americas) UL 61058-1, File 12252
ZX10 Series (Gold-plated contacts)	0.1 A, 125 Vac 0.1 A 48 Vdc, 0.2 A 60 Vdc 10,000 cycles	0.1 A, 125 Vac 0.1 A 48 Vdc, 0.2 A 60 Vdc 10,000 cycles	0.1 RA, 125 Vac 0.1 RA 48 Vdc, 0.2 RA 60 Vdc 10,000 cycles
ZX40 Series (Silver contacts)	3 A, 125 Vac 10,000 cycles	3 A, 125 Vac 10,000 cycles	3 RA, 125 Vac 10,000 cycles

Note: UL, cUL; CQC and ENEC “use temperature”; 0 °C to 55 °C [32 °F to 131 °F].

ZX Series

PRODUCT SPECIFICATIONS AND LISTINGS

Contact your Honeywell rep or distributor for additional listings

- O.F. • Operating force
- R.F. • Release force
- P.T. • Pretravel
- O.T. • Overtravel
- D.T. • Differential travel
- O.P. • Operating position

	Catalog Listing	Contact Material	Elect. Rating Spec. (page 4)	Termination	O.F. max. N [g]	R.F. min. N [g]	O.P. from mounting hole mm [in] (see page 8)	O.P. from plastic switch base mm [in] (see page 8)	O.P. from form in PCB terminals mm [in] (see page 8)	P.T. max. mm [in]	O.T. min. mm [in]	D.T. max. mm [in]
 <p>Pin plunger</p>	ZX10C10A01	Gold Plated	0.1 A	Solder	0,88 [90]	0,15 [15]	5,5 ±0,3 [0.22 ±0.01]	-	-	1,3 [0.05]	0,2 [0.01]	0,3 [0.01]
	ZX10C30A01	Gold Plated	0.1 A	PCB Snap-in	0,88 [90]	0,15 [15]	-	7,0 ±0,3 [0.28 ±0.01]	-	1,3 [0.05]	0,2 [0.01]	0,3 [0.01]
	ZX10C50A01	Gold Plated	0.1 A	PCB Right	0,88 [90]	0,15 [15]	-	-	9,1 ±0,3 [0.36 ±0.01]	1,3 [0.05]	0,2 [0.01]	0,3 [0.01]
	ZX10C60A01	Gold Plated	0.1 A	PCB Left	0,88 [90]	0,15 [15]	-	-	9,1 ±0,3 [0.36 ±0.01]	1,3 [0.05]	0,2 [0.01]	0,3 [0.01]
	ZX10E10A01	Gold Plated	0.1 A	Solder	1,47 [150]	0,2 [20]	5,5 ±0,3 [0.22 ±0.01]	-	-	1,3 [0.05]	0,2 [0.01]	0,3 [0.01]
	ZX40C20A01	Silver	3 A	PCB Straight	0,88 [90]	0,15 [15]	-	7,0 ±0,3 [0.28 ±0.01]	-	1,3 [0.05]	0,2 [0.01]	0,3 [0.01]
	ZX40C30A01	Silver	3 A	PCB Snap-in	0,88 [90]	0,15 [15]	-	7,0 ±0,3 [0.28 ±0.01]	-	1,3 [0.05]	0,2 [0.01]	0,3 [0.01]
	ZX40E10A01	Silver	3 A	Solder	1,47 [150]	0,2 [20]	5,5 ±0,3 [0.22 ±0.01]	-	-	1,3 [0.05]	0,2 [0.01]	0,3 [0.01]
	ZX40E30A01	Silver	3 A	PCB Snap-in	1,47 [150]	0,2 [20]	-	7,0 ±0,3 [0.28 ±0.01]	-	1,3 [0.05]	0,2 [0.01]	0,3 [0.01]
	ZX40E60A01	Silver	3 A	PCB Left	1,47 [150]	0,2 [20]	-	-	9,1 ±0,3 [0.36 ±0.01]	1,3 [0.05]	0,2 [0.01]	0,3 [0.01]
 <p>Std. straight Lever 13 mm [0.51 in]</p>	ZX10C10C01	Gold Plated	0.1 A	Solder	0,29 [30]	0,05 [5]	6,9 ±0,8 [0.27 ±0.03]	-	-	3,4 [0.13]	0,6 [0.02]	1,3 [0.05]
	ZX10C30C01	Gold Plated	0.1 A	PCB Snap-in	0,29 [30]	0,05 [5]	-	8,4 ±0,8 [0.33 ±0.03]	-	3,4 [0.13]	0,6 [0.02]	1,3 [0.05]
	ZX10C50C01	Gold Plated	0.1 A	PCB Right	0,29 [30]	0,05 [5]	-	-	10,5 ±0,8 [0.41 ±0.03]	3,4 [0.13]	0,6 [0.02]	1,3 [0.05]
	ZX10E10C01	Gold Plated	0.1 A	Solder	0,49 [50]	0,08 [8]	6,9 ±0,8 [0.27 ±0.03]	-	-	3,4 [0.13]	0,6 [0.02]	1,3 [0.05]
	ZX10E30C01	Gold Plated	0.1 A	PCB Snap-in	0,49 [50]	0,08 [8]	-	8,4 ±0,8 [0.33 ±0.03]	-	3,4 [0.13]	0,6 [0.02]	1,3 [0.05]
	ZX10E50C01	Gold Plated	0.1 A	PCB Right	0,49 [50]	0,08 [8]	-	-	10,5 ±0,8 [0.41 ±0.03]	3,4 [0.13]	0,6 [0.02]	1,3 [0.05]
	ZX10E60C01	Gold Plated	0.1 A	PCB Left	0,49 [50]	0,08 [8]	-	-	10,5 ±0,8 [0.41 ±0.03]	3,4 [0.13]	0,6 [0.02]	1,3 [0.05]
	ZX40C10C01	Silver	3 A	Solder	0,29 [30]	0,05 [5]	6,9 ±0,8 [0.27 ±0.03]	-	-	3,4 [0.13]	0,6 [0.02]	1,3 [0.05]
	ZX40C30C01	Silver	3 A	PCB Snap-in	0,29 [30]	0,05 [5]	-	8,4 ±0,8 [0.33 ±0.03]	-	3,4 [0.13]	0,6 [0.02]	1,3 [0.05]
	ZX40E10C01	Silver	3 A	Solder	0,49 [50]	0,08 [8]	6,9 ±0,8 [0.27 ±0.03]	-	-	3,4 [0.13]	0,6 [0.02]	1,3 [0.05]
	ZX40E20C01	Silver	3 A	PCB Straight	0,49 [50]	0,08 [8]	-	8,4 ±0,8 [0.33 ±0.03]	-	3,4 [0.13]	0,6 [0.02]	1,3 [0.05]
	ZX40E30C01	Silver	3 A	PCB Snap-in	0,49 [50]	0,08 [8]	-	8,4 ±0,8 [0.33 ±0.03]	-	3,4 [0.13]	0,6 [0.02]	1,3 [0.05]
	ZX40E60C01	Silver	3 A	PCB Left	0,49 [50]	0,08 [8]	-	-	10,5 ±0,8 [0.41 ±0.03]	3,4 [0.13]	0,6 [0.02]	1,3 [0.05]

MICRO SWITCH™ Subminiature Basic Switches

- O.F. • Operating force
- R.F. • Release force
- P.T. • Pretravel
- O.T. • Overtravel
- D.T. • Differential travel
- O.P. • Operating position

	Catalog Listing	Contact Material	Elect. Rating Spec. (page 4)	Termination	O.F. max. N [g]	R.F. min. N [g]	O.P. from mounting hole mm [in] (see page 8)	O.P. from plastic switch base mm [in] (see page 8)	O.P. from form in PCB terminals mm [in] (see page 8)	P.T. max. mm [in]	O.T. min. mm [in]	D.T. max. mm [in]
 Short straight lever 10 mm [0.40 in]	ZX10C30B01	Gold Plated	0.1 A	PCB Snap-in	0,39 [40]	0,06 [6]	-	7,9 ±0,8 [0.31 ±0.03]	-	3,4 [0.13]	0,6 [0.02]	1,0 [0.04]
 Std. sim. roller lever, 11,8 mm [0.47 in]	ZX10C30E01	Gold Plated	0.1 A	PCB Snap-in	0,34 [35]	0,05 [5]	-	11,1 ±0,8 [0.44 ±0.03]	-	3,8 [0.15]	0,6 [0.02]	1,3 [0.05]
	ZX10E10E01	Gold Plated	0.1 A	Solder	0,54 [55]	0,08 [8]	9,6 ±0,8 [0.38 ±0.03]	-	-	3,8 [0.15]	0,6 [0.02]	1,3 [0.05]
	ZX10E20E01	Gold Plated	0.1 A	PCB Straight	0,54 [55]	0,08 [8]	-	11,1 ±0,8 [0.44 ±0.03]	-	3,8 [0.15]	0,6 [0.02]	1,3 [0.05]
	ZX10E50E01	Gold Plated	0.1 A	PCB Right	0,54 [55]	0,08 [8]	-	-	13,2 ±0,8 [0.52 ±0.03]	3,8 [0.15]	0,6 [0.02]	1,3 [0.05]
	ZX40E10E01	Silver	3 A	Solder	0,54 [55]	0,08 [8]	9,6 ±0,8 [0.38 ±0.03]	-	-	3,8 [0.15]	0,6 [0.02]	1,3 [0.05]
	ZX40E30E01	Silver	3 A	PCB Snap-in	0,54 [55]	0,08 [8]	-	11,1 ±0,8 [0.44 ±0.03]	-	3,8 [0.15]	0,6 [0.02]	1,3 [0.05]
	ZX40E50E01	Silver	3 A	PCB Right	0,54 [55]	0,08 [8]	-	-	13,2 ±0,8 [0.52 ±0.03]	3,8 [0.15]	0,6 [0.02]	1,3 [0.05]
 Short sim. roller lever, 10 mm [0.40 in]	ZX10E20G01	Gold Plated	0.1 A	PCB Straight	0,69 [70]	0,06 [6]	-	10,23 ±0,8 [0.40 ±0.03]	-	2,6 [0.10]	0,4 [0.02]	1,0 [0.04]
 Long sim. roller lever 15 mm [0.59 in]	ZX40C30H01	Silver	3 A	PCB Snap-in	0,26 [27]	0,04 [4]	-	10,5 ±0,8 [0.41 ±0.03]	-	3,8 [0.15]	0,6 [0.02]	1,5 [0.06]
 Long straight lever, 30 mm [1.18 in]	ZX10C20J01	Gold Plated	0.1 A	PCB Straight	0,15 [15]	0,02 [2]	-	10,79 ±2,1 [0.42 ±0.08]	-	10,1 [0.4]	0,9 [0.04]	3,0 [0.12]
	ZX10C30J01	Gold Plated	0.1 A	PCB Snap-in	0,15 [15]	0,02 [2]	-	10,79 ±2,1 [0.42 ±0.08]	-	10,1 [0.4]	0,9 [0.04]	3,0 [0.12]
	ZX40E10J01	Silver	3 A	Solder	0,22 [22]	0,03 [3]	9,29 ±2,1 [0.37 ±0.08]	-	-	10,1 [0.40]	0,9 [0.04]	3,0 [0.12]

ZX Series

MOUNTING DIMENSIONS

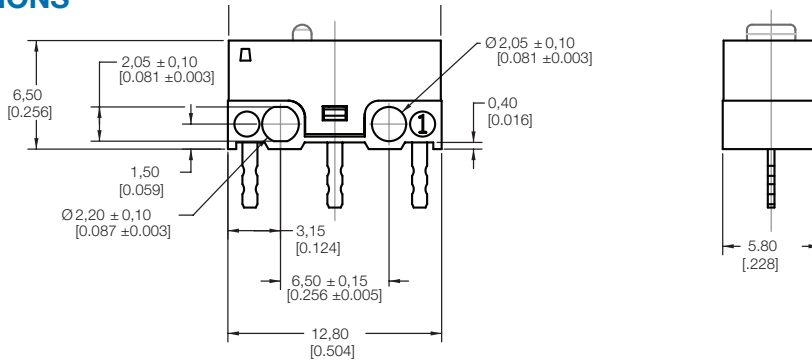

TYPE 10 - SOLDER STRAIGHT



TYPE 20 - PCB STRAIGHT



TYPE 30 -PCB SNAP-IN



TYPE 50 - PCB RIGHT SIDE

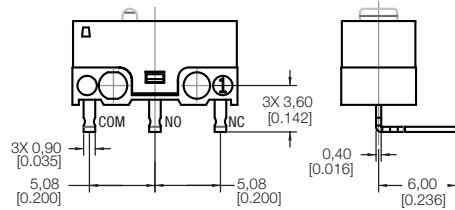

TYPE 60 - PCB LEFT SIDE

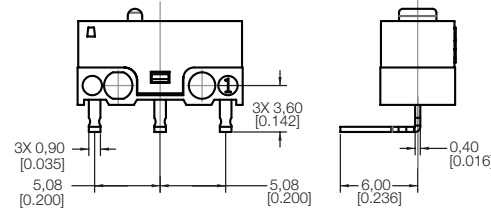

**TYPE A
PIN PLUNGER**

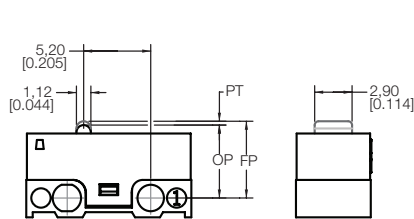

**TYPE B
SHORT STRAIGHT LEVER (10,0 mm)**

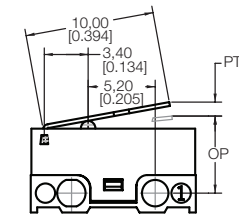

**TYPE C
STANDARD STRAIGHT LEVER (13,0 mm)**

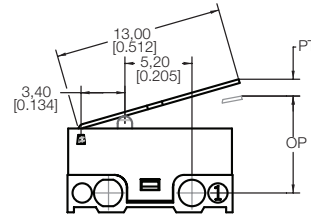

**TYPE E
SIMULATED ROLLER LEVER (11,8 mm; R2,5)**

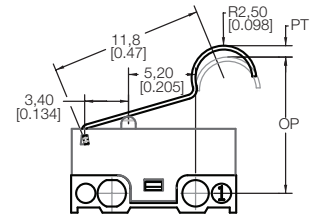

**TYPE F
ROLLER LEVER (10,7 mm, ROLLER Ø4,8)**

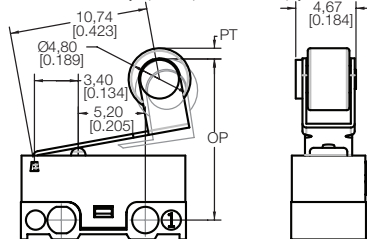

**TYPE G
SIMULATED ROLLER LEVER(10.0 mm,R1.3)**

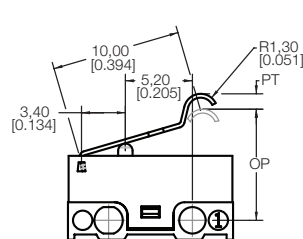

**TYPE H
SIMULATED ROLLER LEVER (15,0 mm; R1.3)**

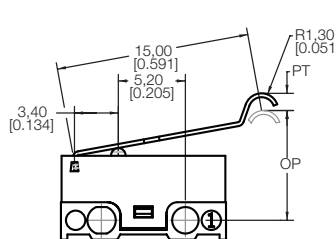

**TYPE J
LONG STRAIGHT LEVER (30,0 mm)**

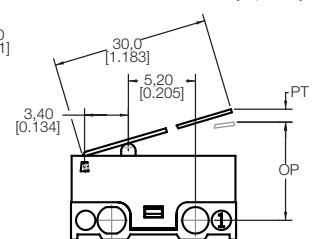

ABOVE OP FROM MOUNTING HOLE

Notes:

1. Unless otherwise specified, tolerance of $\pm 0,4$ mm [0.016 in] applies to all dimensions.
2. All terminal thickness tolerances $\pm 0,05$ mm [0.002 in].

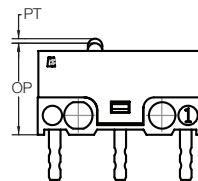

OP FROM BASE
(FOR TYPE 20 & 30 TERMINAL)

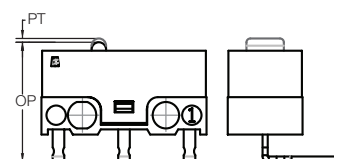

OP FROM TERMINAL
(FOR TYPE 50 & 60 TERMINAL)

ADDITIONAL INFORMATION

The following associated literature is available on the Honeywell web site at sensing.honeywell.com:

- Product installation instructions
- Product range guide
- Product nomenclature tree
- Product application-specific information
 - Application note: Sensors and switches in chemistry analyzers
 - Application note: Sensors and switches for potential HVAC/R applications
 - Application note: Sensors and switches for potential medical applications
 - Technical bulletin: Applying precision switches
 - Technical bulletin: Low energy switch guide

Find out more

Honeywell serves its customers through a worldwide network of sales offices, representatives and distributors. For application assistance, current specifications, pricing or name of the nearest Authorized Distributor, contact your local sales office.

To learn more about Honeywell's sensing and switching products, call **+1-815-235-6847** or **1-800-537-6945**, visit **sensing.honeywell.com**, or e-mail inquiries to **info.sc@honeywell.com**

Sensing and Productivity Solutions
Honeywell
1985 Douglas Drive North
Golden Valley, MN 55422
honeywell.com

WARNING **PERSONAL INJURY**

DO NOT USE these products as safety or emergency stop devices or in any other application where failure of the product could result in personal injury.

Failure to comply with these instructions could result in death or serious injury.

WARNING **MISUSE OF DOCUMENTATION**

- The information presented in this product sheet is for reference only. Do not use this document as a product installation guide.
- Complete installation, operation, and maintenance information is provided in the instructions supplied with each product.

Failure to comply with these instructions could result in death or serious injury.

WARRANTY/REMEDY

Honeywell warrants goods of its manufacture as being free of defective materials and faulty workmanship. Honeywell's standard product warranty applies unless agreed to otherwise by Honeywell in writing; please refer to your order acknowledgement or consult your local sales office for specific warranty details. If warranted goods are returned to Honeywell during the period of coverage, Honeywell will repair or replace, at its option, without charge those items it finds defective. **The foregoing is buyer's sole remedy and is in lieu of all other warranties, expressed or implied, including those of merchantability and fitness for a particular purpose. In no event shall Honeywell be liable for consequential, special, or indirect damages.**

While we provide application assistance personally, through our literature and the Honeywell website, it is up to the customer to determine the suitability of the product in the application.

Specifications may change without notice. The information we supply is believed to be accurate and reliable as of this printing. However, we assume no responsibility for its use.

Honeywell



Компания «ЭлектроПласт» предлагает заключение долгосрочных отношений при поставках импортных электронных компонентов на взаимовыгодных условиях!

Наши преимущества:

- Оперативные поставки широкого спектра электронных компонентов отечественного и импортного производства напрямую от производителей и с крупнейших мировых складов;
- Поставка более 17-ти миллионов наименований электронных компонентов;
- Поставка сложных, дефицитных, либо снятых с производства позиций;
- Оперативные сроки поставки под заказ (от 5 рабочих дней);
- Экспресс доставка в любую точку России;
- Техническая поддержка проекта, помощь в подборе аналогов, поставка прототипов;
- Система менеджмента качества сертифицирована по Международному стандарту ISO 9001;
- Лицензия ФСБ на осуществление работ с использованием сведений, составляющих государственную тайну;
- Поставка специализированных компонентов (Xilinx, Altera, Analog Devices, Intersil, Interpoint, Microsemi, Aeroflex, Peregrine, Syfer, Eurofarad, Texas Instrument, Miteq, Cobham, E2V, MA-COM, Hittite, Mini-Circuits, General Dynamics и др.);

Помимо этого, одним из направлений компании «ЭлектроПласт» является направление «Источники питания». Мы предлагаем Вам помощь Конструкторского отдела:

- Подбор оптимального решения, техническое обоснование при выборе компонента;
- Подбор аналогов;
- Консультации по применению компонента;
- Поставка образцов и прототипов;
- Техническая поддержка проекта;
- Защита от снятия компонента с производства.



Как с нами связаться

Телефон: 8 (812) 309 58 32 (многоканальный)

Факс: 8 (812) 320-02-42

Электронная почта: org@eplast1.ru

Адрес: 198099, г. Санкт-Петербург, ул. Калинина, дом 2, корпус 4, литера А.