

Separate Construction with Minimal Depth

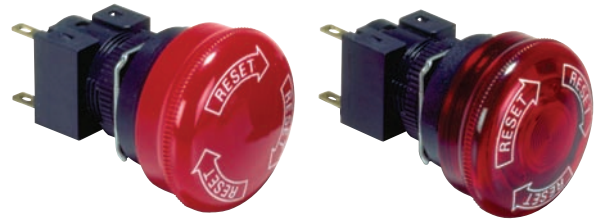

- Direct opening mechanism to open contacts in emergencies, such as when they are welded.
- Conforms to EN 60947-5-5.
- Includes a safety lock to prevent misuse.
- Features separate construction that allows the Switch to be separated for easier wiring and one-piece construction that allows easier handling.
- Models available with 3 contacts built into a single block (A165E-U).





For the most recent information on models that have been certified for safety standards, refer to your OMRON website.

! Be sure to read the "Safety Precautions" on page 9.

Model Number Structure

List of Models

Diameter of Operation Unit	Function	Model	Shape
30-mm models 40-mm models	Push-Lock, turn-reset	A165E	 (30-mm model)
		A165E-□-03U	 (30-mm model)

Model Number Legend (Completely Assembled)

Shipped as a set that includes the Operation Unit and light source.

A165E-LS-24D-02-□

IP65 (Oil-resistant)

1. Operation Unit Shape and Functions

Code	Functions	Pushbutton
S	Non-lighted	30 dia.
LS	Lighted	
M	Non-lighted	40 dia.
LM	Lighted	

2. Light Source

Code	Type	Operation voltage	Rated voltage
None	Non-lighted	---	---
24D	LED	24 VAC/ VDC±5%	24 VAC/ VDC

3. Contacts

Code	Description
01	1NC(1)
02	2NC(2)
03U	3NC(3) *

* 3NC(3) models have one-piece construction with the contact unit. Only non-lighted models are available.

4.

Code	Description
None	Arrows and text printed in white on Pushbutton.
PK	Arrows and text printed in pink on Pushbutton.

Note: Models with separate construction (1NC(1) and 2NC(2)) are for normal loads only. One-piece models (3NC(3)) are for either normal loads or microloads.

Ordering Information

List of Sets

Illumination	Rated voltage	Pushbutton color	Pushbutton size	Terminal	Contact form	Model
LED	24 VAC/VDC	Red	30 dia.	Solder terminal	1NC(1)	A165E-LS-24D-01
						A165E-LS-24D-01-PK
2NC(2)	A165E-LS-24D-02					
	A165E-LS-24D-02-PK					
1NC(1)	A165E-S-01					
	A165E-S-01-PK					
2NC(2)	A165E-S-02					
	A165E-S-02-PK					
LED	24 VAC/VDC		40 dia.		1NC(1)	A165E-LM-24D-01
						A165E-LM-24D-01-PK
2NC(2)	A165E-LM-24D-02					
	A165E-LM-24D-02-PK					
1NC(1)	A165E-M-01					
	A165E-M-01-PK					
2NC(2)	A165E-M-02					
	A165E-M-02-PK					
Non-lighted	---	30 dia.	3NC(3)	A165E-S-03U		
				A165E-S-03U-PK		
		40 dia.		A165E-M-03U		
				A165E-M-03U-PK		



List of Sets (in Different Colors)

Illumination	Pushbutton color *	Pushbutton size	Terminal	Contact form	Model
Non-lighted	Yellow	30 dia.	Solder terminal	1NC(1)	A165E-SY-01
	Gray				A165E-SGR-01
	Yellow			2NC(2)	A165E-SY-02
	Gray				A165E-SGR-02
	Yellow			3NC(3)	A165E-SY-03U
	Gray				A165E-SGR-03U

* Models with yellow or gray pushbutton colors cannot be used as emergency switches.

Individual Parts (for Switches with Separate Construction)

Operation Units

Appearance	Illumination	Model
30 dia. 	Non-lighted	A165E-S
		A165E-S-PK
	Lighted	A165E-LS
		A165E-LS-PK
40 dia. 	Non-lighted	A165E-M
		A165E-M-PK
	Lighted	A165E-LM
		A165E-LM-PK

Lamps

Appearance	LED color		Rated voltage	Model
	Red	Bright	5 VDC	A16-5DSR
			12 VAC/VDC	A16-12DSR
			24 VAC/VDC	A16-24DSR





Switches

Appearance	Illumination	Contact form	Model
	Non-lighted	1NC(1)	A165E-01
		2NC(2)	A165E-02
	Lighted	1NC(1)	A165E-01L
		2NC(2)	A165E-02L

Switch Units

Appearance	Illumination	Contact form	Model
	Lighted	1NC(1)	A165E-R-24D-01
		2NC(2)	A165E-R-24D-02

Accessories (Order Separately)

Item	Appearance	Type	Model	Precautions
Yellow Plate		Yellow, 45 dia.	A16Z-5070	Use this as an emergency stop nameplate.
Panel Plug		Round	A16ZT-3003	Used for covering the panel cutouts for future panel expansion. Degree of protection: IP40 Color: Black
Tightening Tool		---	A16Z-3004	Useful for repetitive mounting. Be careful not to tighten excessively.
Extractor			A16Z-5080	Convenient for extracting the Switch and Lamp.

Specifications

Certified Standard Ratings

UL508, CSA C22.2 No.14, CCC(GB14048.5)

Models with Separate Construction

Rated voltage	Resistive load
125 VAC	5 A
250 VAC	3 A
30 VDC	3 A

Models with One-piece Construction

Rated voltage	Resistive load
125 VAC	1 A
250 VAC	0.5 A
30 VDC	1 A

TÜV(EN60947-5-1)

Models with Separate Construction

Rated voltage	Resistive load
250 VAC	3 A
30 VDC	3 A

Models with One-piece Construction

Rated voltage	Resistive load
250 VAC	0.5 A
30 VDC	1 A

Certified Standards

Certification body	Standards	File No.
UL *	UL508, CSA C22.2 No.14	E76675
TÜV SÜD	EN60947-5-1 (certified direct opening), EN60947-5-5	Consult your OMRON representative for details.
CQC (CCC)	GB14048.5	2003010303070678

* Certification for CSA C22.2 No. 14 has been obtained. Separate construction models have been certified for the Switch Unit.

Switch Ratings

Models with Separate Construction

Rated voltage	Resistive load
125 VAC	5 A
250 VAC	3 A
30 VDC	3 A

Note: Minimum applicable load: 5 VDC, 150 mA

Models with One-piece Construction

Rated voltage	Resistive load
125 VAC	1 A
250 VAC	0.5 A
30 VDC	1 A

Note: Minimum applicable load: 5 VDC, 1 mA

LED Ratings

(Only for Models with LEDs)

Rated voltage	Rated current	Operation voltage
24 VAC/VDC	8 mA	24 VAC/VDC±5%

Characteristics

Item	Type	Emergency Stop Switch		
		Non-lighted A165E-S/A165E-M	Lighted A165E-LS/A165-LM	Non-lighted, One-piece construction A165E-U
Allowable operating frequency	Mechanical	20 operations/minute max.		
	Electrical	10 operations/minute max.		
Insulation resistance		100 MΩ min. (at 500 VDC)		
Dielectric strength	Between terminals of same polarity	1,000 VAC, 50/60 Hz for 1 min		
	Between terminals of different polarity	2,000 VAC 50/60 Hz for 1 min		
	Between each terminal and ground	2,000 VAC 50/60 Hz for 1 min		
	Between lamp terminals	1,000 VAC, 50/60 Hz for 1 min *1	---	
Vibration resistance	Malfunction	10 to 55 Hz, 1.5-mm double amplitude (malfunction within 1 ms)		
Shock resistance	Destruction	500 m/s ²		
	Malfunction	300 m/s ² max. (malfunction within 1 ms)	150 m/s ² max. (malfunction within 1 ms)	
Durability	Mechanical	100,000 operations min.		
	Electrical	100,000 operations min.		
Degree of protection		IP65 Oil-resistant *2	IP65 *2	IP65 Oil-resistant *2
Electric shock protection class		Class II		
PTI (tracking characteristic)		175		
Degree of contamination		3 (EN60947-5-1)		
Weight		Approx. 16 g (in case of 2NC(2) Switches)		
Ambient operating temperature		-10 to 55°C (with no icing or condensation)		
Ambient operating humidity		35% to 85%		
Ambient storage temperature		-25 to 65°C (with no icing or condensation)		

*1. LED not mounted. (Test them with the LED removed.)

*2. Degree of protection from the front of the panel.

Operating Characteristics

Item	Type	Characteristics of models with separate construction	Characteristics of models with one-piece construction
Operating force	OF max.	14.7 N	14.7 N
Releasing torque	RF max.	0.1 N·m	0.1 N·m
Pretravel	PT	3.5±0.5 mm	3±0.5 mm

Structure and Nomenclature



* Models with yellow or gray pushbutton colors cannot be used as emergency switches.

Dimensions

A165E-S

Non-lighted models
30 mm diameter

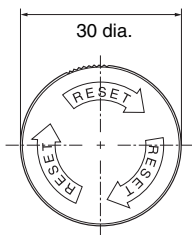

- When applying a coating such as paint to the panel, dimensions after the coating must satisfy the specified dimensions.
- Recommended panel thickness: 0.5 to 3.2 mm.

A165E-LS

Lighted models
30 mm diameter

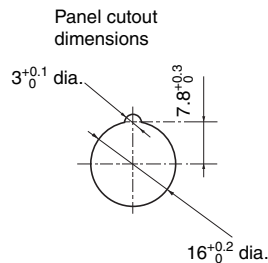

- When applying a coating such as paint to the panel, dimensions after the coating must satisfy the specified dimensions.
- Recommended panel thickness: 0.5 to 3.2 mm.

A165E-S-03U

Non-lighted,
One-piece construction models
30 mm diameter

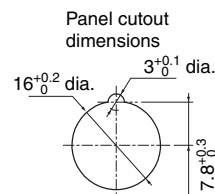
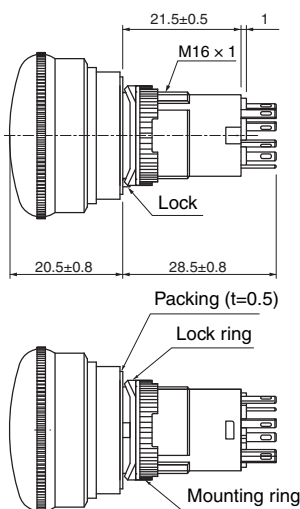

- When applying a coating such as paint to the panel, dimensions after the coating must satisfy the specified dimensions.
- Recommended panel thickness: 0.5 to 3.2 mm.

A165E-M

Non-lighted models
40 mm diameter

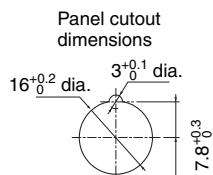
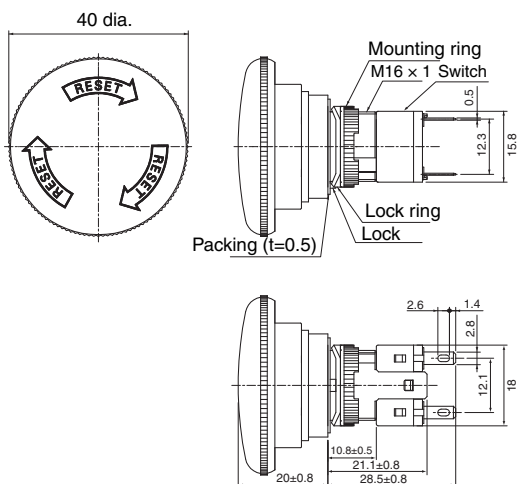
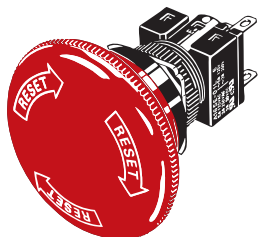

- When applying a coating such as paint to the panel, dimensions after the coating must satisfy the specified dimensions.
- Recommended panel thickness: 0.5 to 3.2 mm.

A165E-LM

Lighted models
40 mm diameter

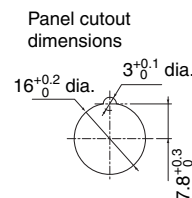
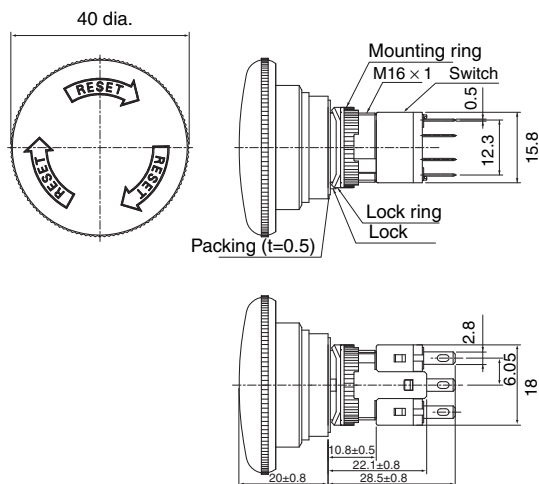
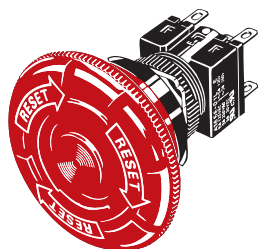

- When applying a coating such as paint to the panel, dimensions after the coating must satisfy the specified dimensions.
- Recommended panel thickness: 0.5 to 3.2 mm.

A165E-M-03U

One-piece construction models
40 mm diameter

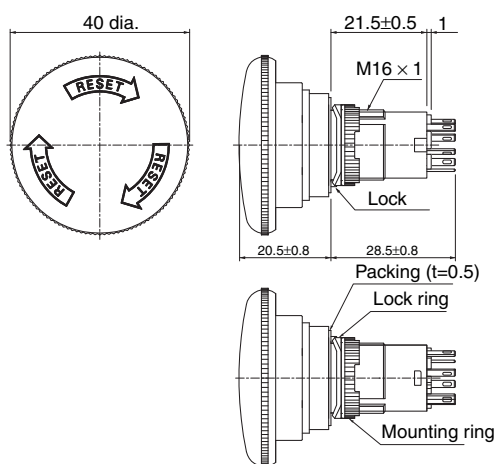
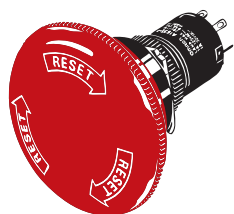

- When applying a coating such as paint to the panel, dimensions after the coating must satisfy the specified dimensions.
- Recommended panel thickness: 0.5 to 3.2 mm.

Accessories

Yellow Plate (Vinyl Chloride)

A16Z-5070



Lock Ring



Panel Plugs (Round Type)

A16ZT-3003



- Select an appropriate Panel Plug according to the panel design and mount from the front side of the panel. Panel cutout dimensions are the same as those for the Operation Unit.

Tightening Tool

A16Z-3004

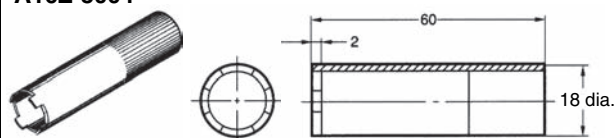

Terminal Arrangement

1NC(1)	2NC(2)	3NC(3)

Note: The L+ and L- terminals are not available with the non-lighted models.

Installation

Mounting to the Panel (Models with Separate Construction)

After installing the Operation Unit, snap in the Switch from the back of the panel.

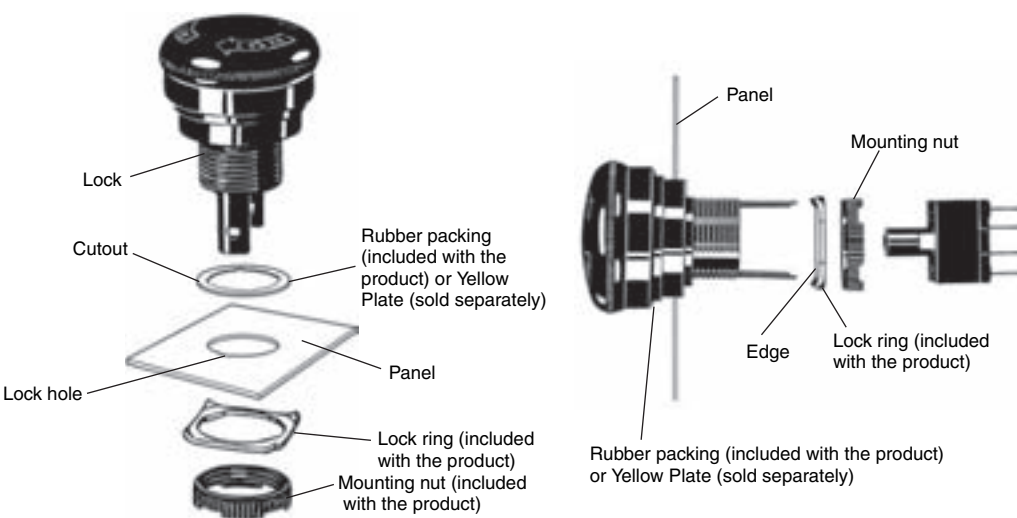
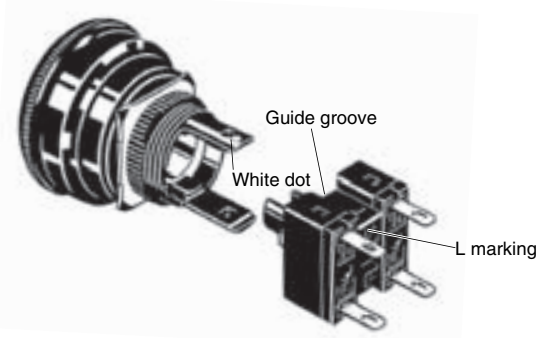
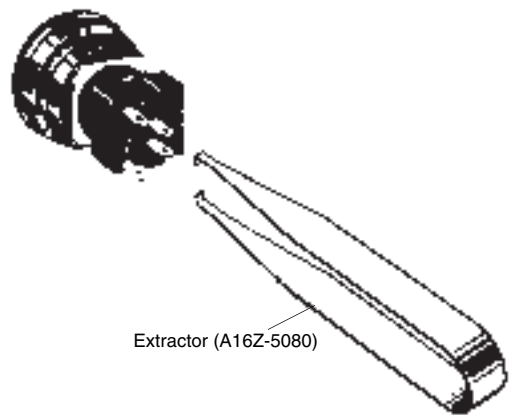
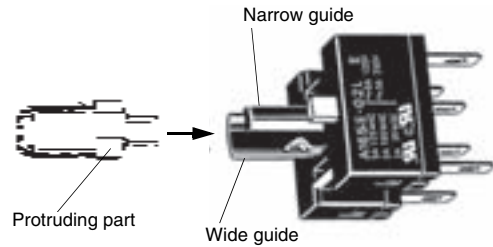
(1) Installing the Operation Unit	
<ul style="list-style-type: none"> • Attach rubber packing or the Yellow Plate onto the Operation Unit from its terminal side. Insert the Operation Unit into the panel from the front. Install the lock ring and mounting nut from the terminal side and tighten. • Adjust the slits on the hole of rubber packing and Yellow Plate to the protruding part of the Unit. • Rubber packing is not necessary when the Yellow Plate is used. • Tighten the nut to the torque of 0.29 to 0.49 N·m. • The Operation Unit should be installed with its protruding part adjusted to the slit of the panel hole. • Align the lock ring to the groove of the Operation Unit so that the edge is drawn to the panel side. 	
(2) Mounting the Switch	(3) Removing the Switch
<ul style="list-style-type: none"> • Snap on the Switch to the Operation Unit. • Make sure that the Switch has the correct orientation when snapping it onto the Operation Unit. • Align the white dot on the Operation Unit with the guide groove on the side of the Switch marked with an "L" as shown below, and push the Switch into the Operation Unit until it clicks into place. Confirm that the Switch is securely in place before using. 	<ul style="list-style-type: none"> • Insert the prongs of the A16Z-5080 Extractor between the Switch and the Operation Unit, grip the Switch, and pull to remove. 
(4) Installing the LED Lamp	
<ul style="list-style-type: none"> • When mounting the Lamp, make sure it is facing the direction shown in the following diagram. Insert the Lamp while matching the protruding part of the Lamp and the small guides on the outer surface of the switch. 	

Safety Precautions

Be sure to read the precautions for all A165E models in the website at: <http://www.ia.omron.com/>.

Indication and Meaning for Safe Use

⚠ CAUTION	Indicates a potentially hazardous situation which, if not avoided, may result in minor or moderate injury or in property damage.
Precautions for Safe Use	Supplementary comments on what to do or avoid doing, to use the product safely.

⚠ CAUTION

If the Operation Unit is separated from the Switch Unit, the equipment will not stop, creating a hazardous condition. Always confirm that safety functions are operating before starting operation.



Precautions for Correct Use

Mounting

- Always make sure that the power is turned OFF before mounting, removing, or wiring the Switch, or performing maintenance. Electrical shock or fire may result if the power is not turned OFF.
- The tightening torque is 0.29 to 0.49 N·m.

Wiring

- Be sure to use electrical wires that are a size appropriate for the applied voltage and carry current. Perform soldering according to the conditions given below. If the soldering is not properly performed, abnormal heating may result, possibly resulting in fire.
 1. Hand soldering: 30 W, within 5 s
 2. Dip soldering: 240°C, within 3 s
 Wait for one minute after soldering before exerting any external force on the solder.
- Use non-corrosive resin fluid as the flux.
- Make sure that the electric cord is wired so that it does not touch the Unit. If the electric cord will touch the Unit, then electric wires with a heat resistance of 100°C min. must be used.
- After wiring the Switch, maintain an appropriate clearance and creepage distance.

Operating Environment

- The IP65 model is designed with a degree of protection so that it will not sustain damage if it is subjected to water from any direction to the front of the panel.
- The Switch is intended for indoor use only. Using the Switch outdoor may cause it to fail.

Using the Microload

- Insert a contact protection circuit, if necessary, to prevent the reduction of life expectancy due to extreme wear on the contacts caused by loads where inrush current occurs when the contact is opened and closed.
- The A165E-□U (one-piece construction) allows both a standard load (125 V at 1 A, 250 V at 0.5 A) and a microload. If a standard load is applied, however, the microload area cannot be used. If the microload area is used with a standard load, the contact surface will become rough, and the opening and closing of the contact for a microload may become unreliable.
- The minimum applicable load is the N-level reference value. This value indicates the malfunction reference level for the reliability level of 60% (λ_{60}) (conforming to JIS C5003).
- The equation, $\lambda_{60} = 0.5 \times 10^{-6}/\text{time}$ indicates that the estimated malfunction rate is less than 1/2,000,000 with a reliability level of 60%.

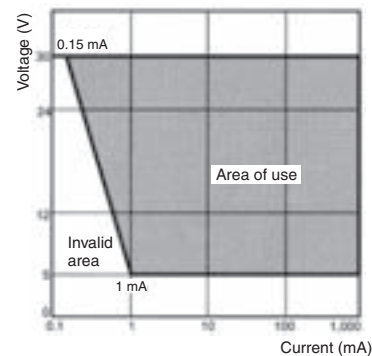

LEDs

The LED current-limiting resistor is built-in, so external resistance is not required.

Rated voltage	Internal limiting resistor
24 VAC/VDC	2.4 kΩ

Operating Torque

- Do not exceed an operating torque of 0.49 N·m in the direction of rotation.
- Do not pull the operating button or apply excessive force to any side of the button. Otherwise it may be damaged.

Others

- The oil-resistant IP65 uses NBR rubber and is resistant to general cutting oil and cooling oil. Some special oils cannot be used with the oil-resistant IP65, however, so contact your OMRON representative for details.
- If the panel is to be coated, make sure that the panel meets the specified dimensions after coating.
- Due to the structure of the Switch, severe shock or vibration may cause malfunctions or damage to the Switch.
Also, most Switches are made from resin and will be damaged if they come into contact with sharp objects. Particularly scratches on the Operation Unit may create visual and operational obtrusions. Handle the Switches with care, and do not throw or drop them.

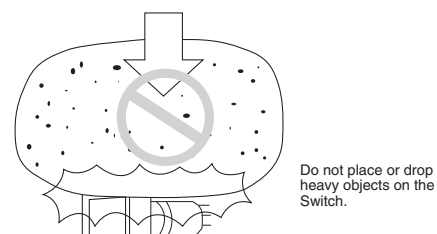

Terms and Conditions Agreement

Read and understand this catalog.

Please read and understand this catalog before purchasing the products. Please consult your OMRON representative if you have any questions or comments.

Warranties.

(a) Exclusive Warranty. Omron's exclusive warranty is that the Products will be free from defects in materials and workmanship for a period of twelve months from the date of sale by Omron (or such other period expressed in writing by Omron). Omron disclaims all other warranties, express or implied.

(b) Limitations. OMRON MAKES NO WARRANTY OR REPRESENTATION, EXPRESS OR IMPLIED, ABOUT NON-INFRINGEMENT, MERCHANTABILITY OR FITNESS FOR A PARTICULAR PURPOSE OF THE PRODUCTS. BUYER ACKNOWLEDGES THAT IT ALONE HAS DETERMINED THAT THE PRODUCTS WILL SUITABLY MEET THE REQUIREMENTS OF THEIR INTENDED USE.

Omron further disclaims all warranties and responsibility of any type for claims or expenses based on infringement by the Products or otherwise of any intellectual property right. (c) Buyer Remedy. Omron's sole obligation hereunder shall be, at Omron's election, to (i) replace (in the form originally shipped with Buyer responsible for labor charges for removal or replacement thereof) the non-complying Product, (ii) repair the non-complying Product, or (iii) repay or credit Buyer an amount equal to the purchase price of the non-complying Product; provided that in no event shall Omron be responsible for warranty, repair, indemnity or any other claims or expenses regarding the Products unless Omron's analysis confirms that the Products were properly handled, stored, installed and maintained and not subject to contamination, abuse, misuse or inappropriate modification. Return of any Products by Buyer must be approved in writing by Omron before shipment. Omron Companies shall not be liable for the suitability or unsuitability or the results from the use of Products in combination with any electrical or electronic components, circuits, system assemblies or any other materials or substances or environments. Any advice, recommendations or information given orally or in writing, are not to be construed as an amendment or addition to the above warranty.

See <http://www.omron.com/global/> or contact your Omron representative for published information.

Limitation on Liability; Etc.

OMRON COMPANIES SHALL NOT BE LIABLE FOR SPECIAL, INDIRECT, INCIDENTAL, OR CONSEQUENTIAL DAMAGES, LOSS OF PROFITS OR PRODUCTION OR COMMERCIAL LOSS IN ANY WAY CONNECTED WITH THE PRODUCTS, WHETHER SUCH CLAIM IS BASED IN CONTRACT, WARRANTY, NEGLIGENCE OR STRICT LIABILITY.

Further, in no event shall liability of Omron Companies exceed the individual price of the Product on which liability is asserted.

Suitability of Use.

Omron Companies shall not be responsible for conformity with any standards, codes or regulations which apply to the combination of the Product in the Buyer's application or use of the Product. At Buyer's request, Omron will provide applicable third party certification documents identifying ratings and limitations of use which apply to the Product. This information by itself is not sufficient for a complete determination of the suitability of the Product in combination with the end product, machine, system, or other application or use. Buyer shall be solely responsible for determining appropriateness of the particular Product with respect to Buyer's application, product or system. Buyer shall take application responsibility in all cases.

NEVER USE THE PRODUCT FOR AN APPLICATION INVOLVING SERIOUS RISK TO LIFE OR PROPERTY OR IN LARGE QUANTITIES WITHOUT ENSURING THAT THE SYSTEM AS A WHOLE HAS BEEN DESIGNED TO ADDRESS THE RISKS, AND THAT THE OMRON PRODUCT(S) IS PROPERLY RATED AND INSTALLED FOR THE INTENDED USE WITHIN THE OVERALL EQUIPMENT OR SYSTEM.

Programmable Products.

Omron Companies shall not be responsible for the user's programming of a programmable Product, or any consequence thereof.

Performance Data.

Data presented in Omron Company websites, catalogs and other materials is provided as a guide for the user in determining suitability and does not constitute a warranty. It may represent the result of Omron's test conditions, and the user must correlate it to actual application requirements. Actual performance is subject to the Omron's Warranty and Limitations of Liability.

Change in Specifications.

Product specifications and accessories may be changed at any time based on improvements and other reasons. It is our practice to change part numbers when published ratings or features are changed, or when significant construction changes are made. However, some specifications of the Product may be changed without any notice. When in doubt, special part numbers may be assigned to fix or establish key specifications for your application. Please consult with your Omron's representative at any time to confirm actual specifications of purchased Product.

Errors and Omissions.

Information presented by Omron Companies has been checked and is believed to be accurate; however, no responsibility is assumed for clerical, typographical or proofreading errors or omissions.

Mouser Electronics

Authorized Distributor

Click to View Pricing, Inventory, Delivery & Lifecycle Information:

Omron:

[A165E-S-01](#) [A165E-S-02](#) [A165E-S-03U](#) [A165E-01](#) [A165E-01L](#) [A165E-02](#) [A165E-02L](#) [A165E-LM](#) [A165E-LM-24D-01](#) [A165E-LM-24D-02](#) [A165E-LS](#) [A165E-M](#) [A165E-M-02](#) [A165E-R-24D-01](#) [A165E-S](#) [A165E-S-01\(STOP\)](#) [A165E-S-02\(STOP\)](#) [A165E-SY](#) [A165E-SY-01](#) [A165E-M-03U](#) [A165E-S-03U-S](#)



Компания «ЭлектроПласт» предлагает заключение долгосрочных отношений при поставках импортных электронных компонентов на взаимовыгодных условиях!

Наши преимущества:

- Оперативные поставки широкого спектра электронных компонентов отечественного и импортного производства напрямую от производителей и с крупнейших мировых складов;
- Поставка более 17-ти миллионов наименований электронных компонентов;
- Поставка сложных, дефицитных, либо снятых с производства позиций;
- Оперативные сроки поставки под заказ (от 5 рабочих дней);
- Экспресс доставка в любую точку России;
- Техническая поддержка проекта, помощь в подборе аналогов, поставка прототипов;
- Система менеджмента качества сертифицирована по Международному стандарту ISO 9001;
- Лицензия ФСБ на осуществление работ с использованием сведений, составляющих государственную тайну;
- Поставка специализированных компонентов (Xilinx, Altera, Analog Devices, Intersil, Interpoint, Microsemi, Aeroflex, Peregrine, Syfer, Eurofarad, Texas Instrument, Miteq, Cobham, E2V, MA-COM, Hittite, Mini-Circuits, General Dynamics и др.);

Помимо этого, одним из направлений компании «ЭлектроПласт» является направление «Источники питания». Мы предлагаем Вам помощь Конструкторского отдела:

- Подбор оптимального решения, техническое обоснование при выборе компонента;
- Подбор аналогов;
- Консультации по применению компонента;
- Поставка образцов и прототипов;
- Техническая поддержка проекта;
- Защита от снятия компонента с производства.



Как с нами связаться

Телефон: 8 (812) 309 58 32 (многоканальный)

Факс: 8 (812) 320-02-42

Электронная почта: org@eplast1.ru

Адрес: 198099, г. Санкт-Петербург, ул. Калинина, дом 2, корпус 4, литера А.