

PROTECTION PRODUCTS - MicroClamp®

Description

The µClamp®3601P is a high-surge transient voltage suppressor (TVS) optimized for protection of sensitive digital sensors used in proximity switches and industrial control applications. The µClamp3601P protects the components from over-voltages caused by **Electro-Static Discharge (ESD)**, **Electrical Fast Transients (EFT)**, and **Tertiary Lightning**.

The µClamp3601P features a working voltage of 33 volts with a minimum breakdown voltage of 34 volts. They are rated to handle a continuous forward current of up to 260mA with a low forward voltage drop of less than 1 volt ($I_F = 200\text{mA}$). They are designed with high surge capability (2 Amps at $t_p = 1.2/50\mu\text{s}$) and a low clamping voltage of <60V.

The µClamp3601P is in an 2-pin SLP1006P2 package. It measures 1.0 x 0.6 x 0.5mm. The leads are spaced at a pitch of 0.65mm and are finished with lead-free NiPdAu. Each device will protect one line operating at 33 volts. The small size and unique features of the µClamp3601P make it ideal for protection of DC high-side proximity switches in industrial and automotive applications.

The µClamp3601P is qualified to AEC-Q100 Grade1.

Features

- ◆ Transient protection for data and power lines to **IEC 61000-4-2 (ESD) ±20kV (air), ±15kV (contact)**
- ◆ **IEC 61000-4-4 (EFT) 40A (5/50ns)**
- ◆ **IEC 61000-4-5 (Lightning) 2A (1.2/50µs)**
- ◆ Ultra-small package
- ◆ Bidirectionally protects one data line
- ◆ Low clamping voltage
- ◆ Working voltage: 33V
- ◆ Low leakage current
- ◆ Solid-state silicon-avalanche technology
- ◆ Qualified to AEC-Q100 Grade1

Mechanical Characteristics

- ◆ SLP1006P2 package
- ◆ Pb-Free, Halogen Free, RoHS/WEEE Compliant
- ◆ Nominal Dimensions: 1.0 x 0.6 x 0.5 mm
- ◆ Lead Finish: NiPdAu
- ◆ Molding compound flammability rating: UL 94V-0
- ◆ Marking: Marking code, cathode band
- ◆ Packaging: Tape and Reel

Applications

- ◆ Two, Three, and Four Wire DC High-Side Proximity Switches
- ◆ Digital Sensor Input Protection
- ◆ Industrial Controls
- ◆ 24V - 33V DC Supply Protection
- ◆ Automotive Applications

Dimensions

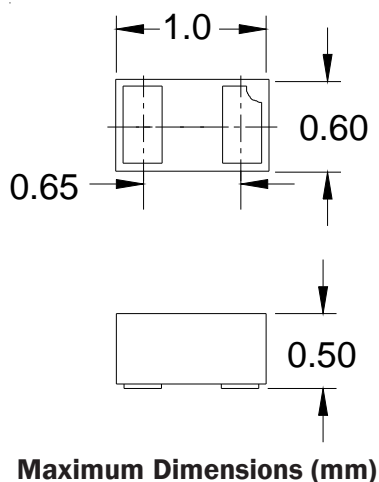

Schematic & Pin Configuration

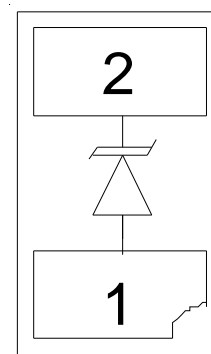

SLP1006P2 (Bottom View)

PROTECTION PRODUCTS
Absolute Maximum Ratings

Rating	Symbol	Value	Units
Peak Pulse Power ($t_p = 8/20\mu s$)	P_{pk}	170	Watts
Peak Pulse Power ($t_p = 1.2/50\mu s$)	P_{pk}	125	Watts
Peak Pulse Current ($t_p = 1.2/50\mu s$)	I_{pp}	2	A
ESD per IEC 61000-4-2 (Air) ESD per IEC 61000-4-2 (Contact)	V_{ESD}	+/- 20 +/- 15	kV
Continuous Forward Current	I_{FMAX}	260	mA
Operating Temperature	T_J	-40 to +125	°C
Storage Temperature	T_{STG}	-55 to +150	°C

Electrical Characteristics (T=25°C unless otherwise specified)

Parameter	Symb-ol	Conditions	Minimum	Typical	Maximum	Units
Reverse Stand-Off Voltage	V_{RWM}				33	V
Reverse Breakdown Voltage	V_{BR}	$I_t = 1mA$	T=25 °C		36	V
			T=-40 °C to 125 °C		34	
Reverse Leakage Current	I_R	$V_{RWM} = 33V$	T=25 °C		1	µA
			T=125 °C			
Forward Voltage	V_F	$I_F = 200mA$			1	V
Clamping Voltage	V_C	$I_{pp} = 2A, t_p = 1.2/50\mu s$			60	V
Junction Capacitance	C_j	$V_R = 0V,$ $f = 1MHz$	T=25 °C		25	pF
			T=-40 °C to 125 °C			

PROTECTION PRODUCTS

Typical Characteristics

Non-Repetitive Peak Pulse Power vs. Pulse Time

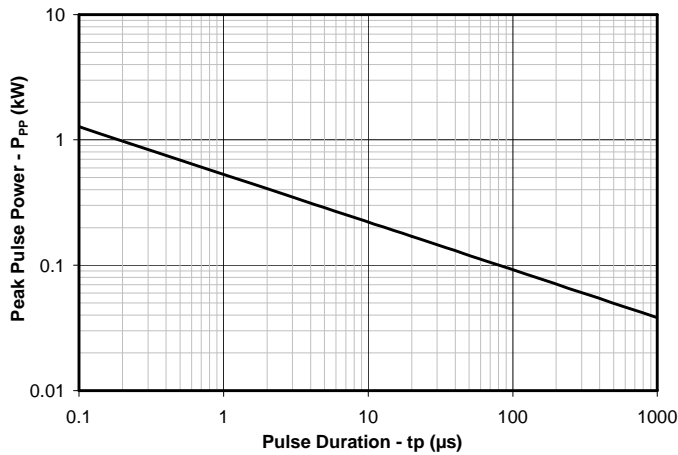

Power Derating Curve

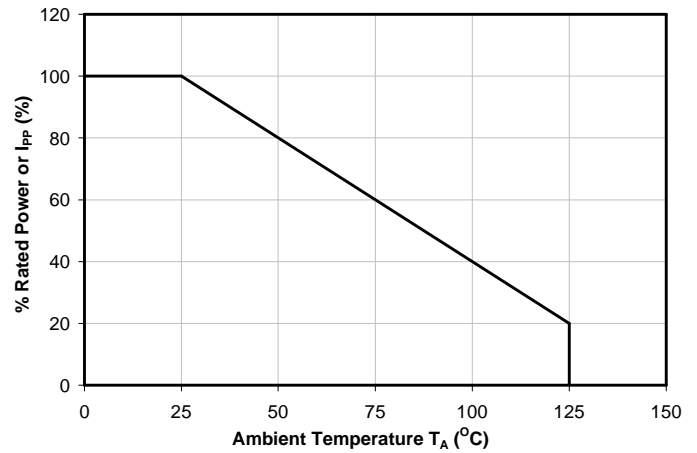

Clamping Voltage vs. Peak Pulse Current

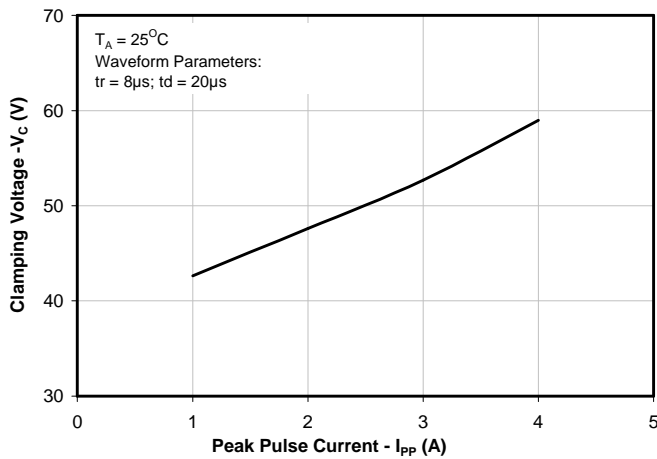

**ESD Clamping
(8kV Contact per IEC 61000-4-2)**

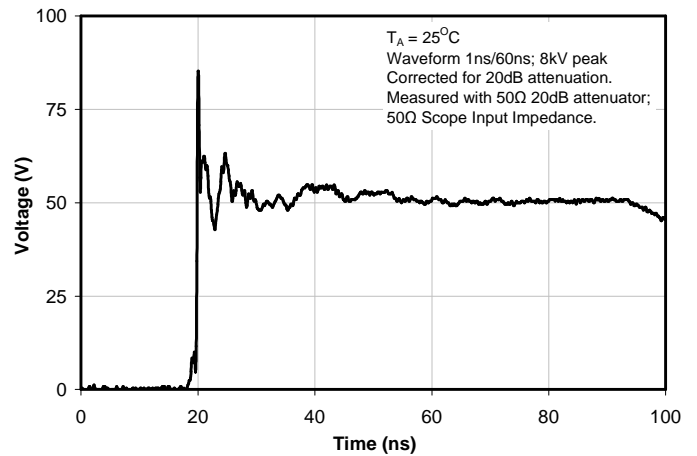

Forward Voltage vs. Forward Current

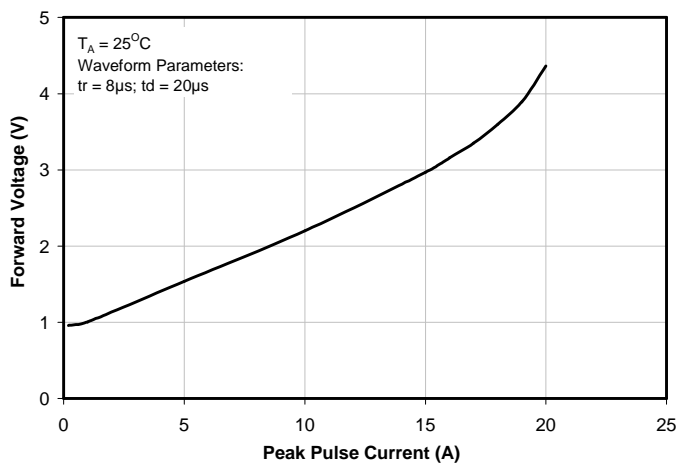

Junction Capacitance vs. Reverse Voltage

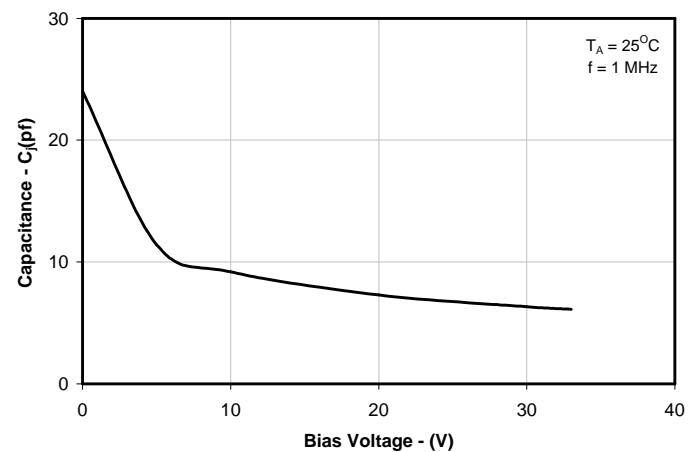

PROTECTION PRODUCTS

Typical Characteristics

Typical Positive Clamping Voltage vs Surge Voltage

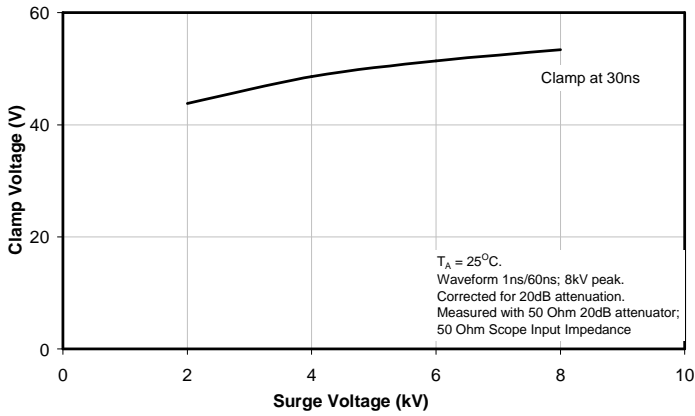

Typical Negative Clamping Voltage vs Surge Voltage

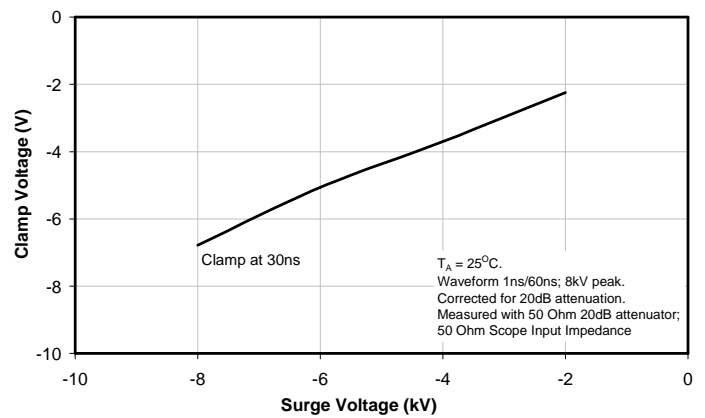

Typical Junction Capacitance vs Temperature

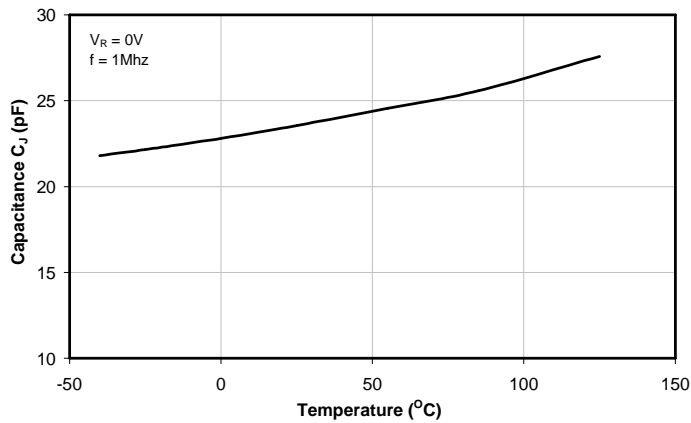

Typical Leakage Current vs Reverse Voltage

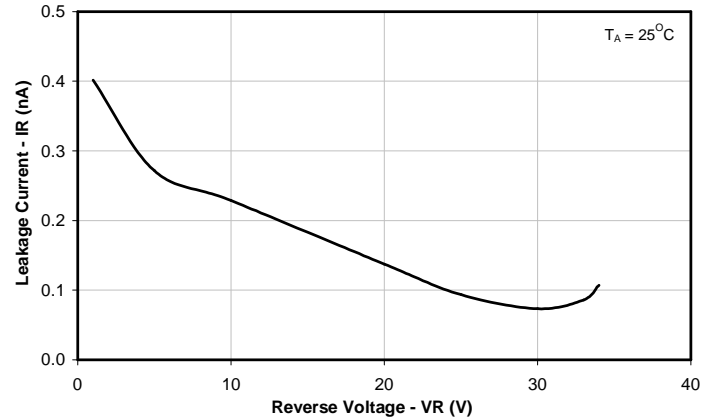

Typical Leakage Current vs Temperature

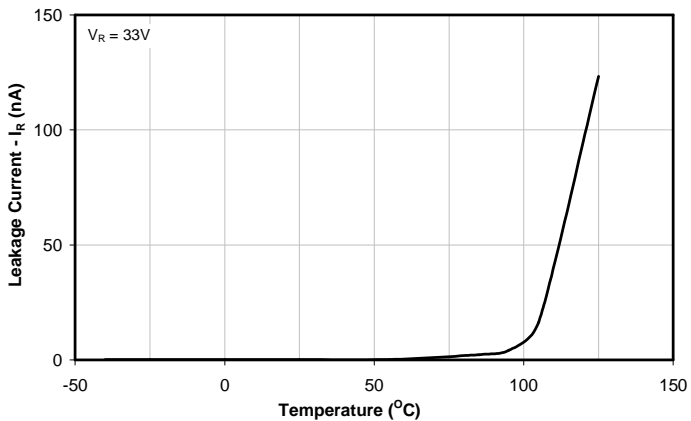

Typical Breakdown Voltage vs Temperature

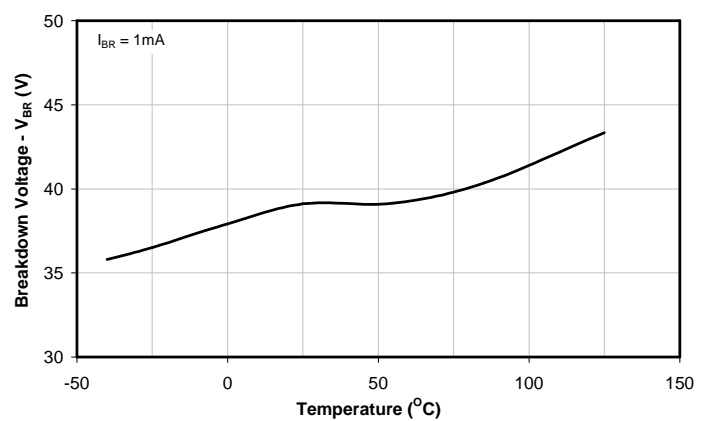

PROTECTION PRODUCTS

Typical Characteristics

Typical Insertion Loss

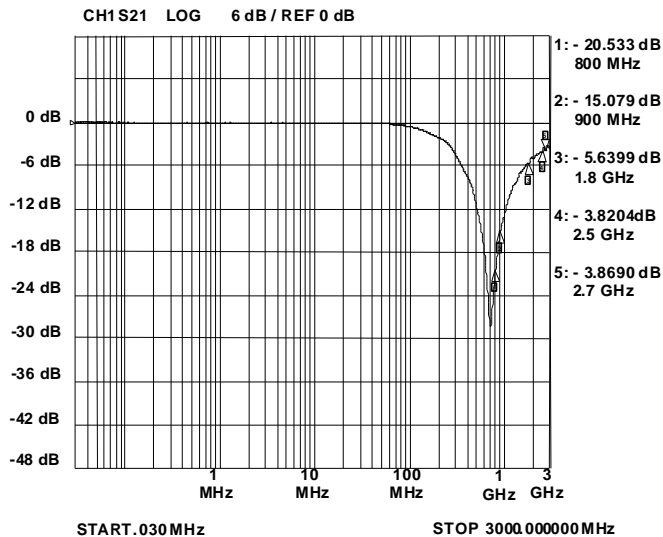

Applications Information

Device Connection for Protection of Two, Three, and Four Wire Proximity Switches

Digital sensors help to bridge the gap between the physical world and the digital world in applications such as computer controlled factory automation. In such environments, transient voltages can easily disrupt or damage sensitive sensor inputs. The μ Clamp3601P provides transient voltage protection for the digital sensors to ESD, lightning, and CDE events.

The μ Clamp3601P is designed to meet the high surge capability and low clamping voltage needed to protect the ASIC and control logic used in proximity switches. The μ Clamp3601P provides protection for the power and I/O lines.

Device Schematic & Pin Configuration

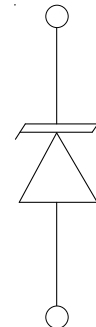

Application Example

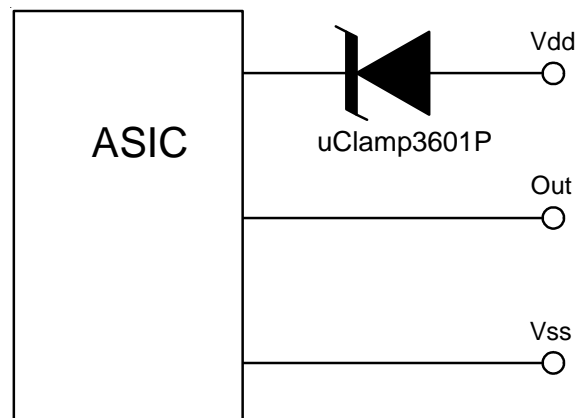

PROTECTION PRODUCTS

Outline Drawing - SLP1006P2

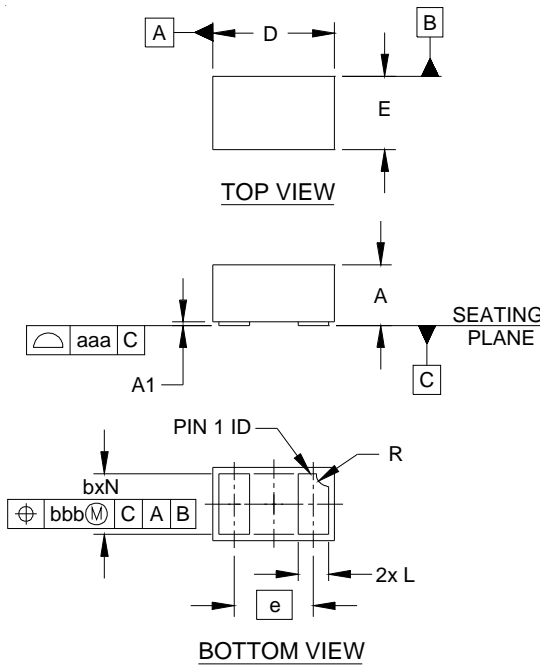

DIM	INCHES		MILLIMETERS			
	MIN	NOM	MAX	MIN	NOM	MAX
A	.016	.020	.022	0.40	0.50	0.55
A1	.000	.001	.002	0.00	0.03	0.05
b	.018	.020	.022	0.45	0.50	0.55
D	.035	.039	.043	0.90	1.00	1.10
E	.020	.024	.028	0.50	0.60	0.70
e	.026 BSC		0.65 BSC			
L	.008	.010	.012	0.20	0.25	0.30
R	.002	.004	.006	0.05	0.10	0.15
N	2		2			
aaa	.003		0.08			
bbb	.004		0.10			

NOTES:

1. CONTROLLING DIMENSIONS ARE IN MILLIMETERS (ANGLES IN DEGREES).

Land Pattern - SLP1006P2

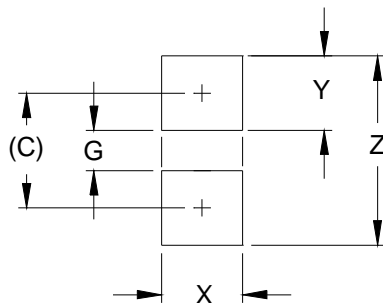

DIM	DIMENSIONS	
	INCHES	MILLIMETERS
C	(.033)	(0.85)
G	.012	0.30
X	.024	0.60
Y	.022	0.55
Z	.055	1.40

NOTES:

1. CONTROLLING DIMENSIONS ARE IN MILLIMETERS (ANGLES IN DEGREES).
2. THIS LAND PATTERN IS FOR REFERENCE PURPOSES ONLY. CONSULT YOUR MANUFACTURING GROUP TO ENSURE YOUR COMPANY'S MANUFACTURING GUIDELINES ARE MET.

PROTECTION PRODUCTS

Marking

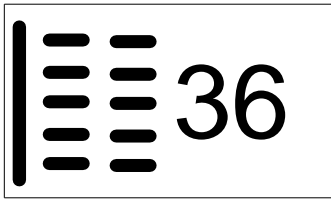

Notes:

1) Marking will also include line matrix date code

Ordering Information

Part Number	Qty per Reel	Reel Size
uClamp3601P.TNT	10,000	7 Inch

Notes:

1) MicroClamp, uClamp and μ Clamp are trademarks of Semtech Corporation

Tape and Reel Specification

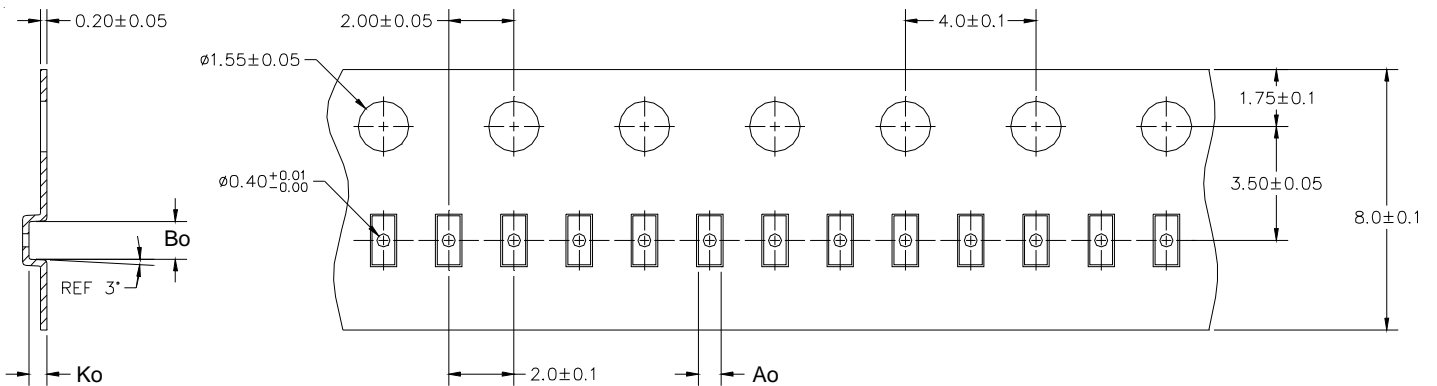

Device Orientation in Tape

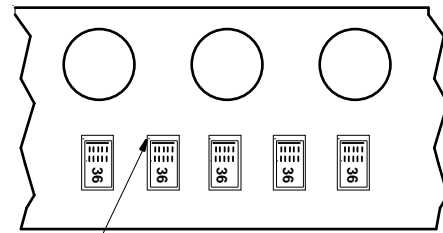

Cathode Band Location
(Towards Sprocket Holes)

A0	B0	K0
0.69 +/-0.10 mm	1.19 +/-0.10 mm	0.66 +/-0.10 mm

Note: All dimensions in mm unless otherwise specified

Contact Information

Semtech Corporation
 Protection Products Division
 200 Flynn Rd., Camarillo, CA 93012
 Phone: (805)498-2111 FAX (805)498-3804



Компания «ЭлектроПласт» предлагает заключение долгосрочных отношений при поставках импортных электронных компонентов на взаимовыгодных условиях!

Наши преимущества:

- Оперативные поставки широкого спектра электронных компонентов отечественного и импортного производства напрямую от производителей и с крупнейших мировых складов;
- Поставка более 17-ти миллионов наименований электронных компонентов;
- Поставка сложных, дефицитных, либо снятых с производства позиций;
- Оперативные сроки поставки под заказ (от 5 рабочих дней);
- Экспресс доставка в любую точку России;
- Техническая поддержка проекта, помощь в подборе аналогов, поставка прототипов;
- Система менеджмента качества сертифицирована по Международному стандарту ISO 9001;
- Лицензия ФСБ на осуществление работ с использованием сведений, составляющих государственную тайну;
- Поставка специализированных компонентов (Xilinx, Altera, Analog Devices, Intersil, Interpoint, Microsemi, Aeroflex, Peregrine, Syfer, Eurofarad, Texas Instrument, Miteq, Cobham, E2V, MA-COM, Hittite, Mini-Circuits, General Dynamics и др.);

Помимо этого, одним из направлений компании «ЭлектроПласт» является направление «Источники питания». Мы предлагаем Вам помощь Конструкторского отдела:

- Подбор оптимального решения, техническое обоснование при выборе компонента;
- Подбор аналогов;
- Консультации по применению компонента;
- Поставка образцов и прототипов;
- Техническая поддержка проекта;
- Защита от снятия компонента с производства.



Как с нами связаться

Телефон: 8 (812) 309 58 32 (многоканальный)

Факс: 8 (812) 320-02-42

Электронная почта: org@eplast1.ru

Адрес: 198099, г. Санкт-Петербург, ул. Калинина, дом 2, корпус 4, литера А.