

# Cree® PLCC4 1 in 1 SMD LED CLM2B-REW/AEW



## PRODUCT DESCRIPTION

SMD LEDs is packaged in the industry standard package. These LEDs have high reliability performance and are designed to work under a wide range of environmental conditions.

This high reliability feature makes them ideally suited to be used under illumination application conditions.

Its wide viewing angle makes these LEDs ideally suited for channel letter, or general backlighting and illumination applications.

## FEATURES

- Size (mm): 3.2 x 2.7
- Color and Typical Dominant Wavelength:  
Red (624nm)  
Amber(591nm)
- Luminous Intensity (mcd)  
CLM2B-REW:  
(2240 - 5600)  
CLM2B-AEW:  
(2800 - 9000)
- Viewing angle: 60 degree
- Lead-Free
- RoHS Compliant

## APPLICATIONS

- Light Strip
- Channel Letter
- Architectural Lighting

## ABSOLUTE MAXIMUM RATINGS ( $T_A = 25^\circ\text{C}$ )

Items	Symbol	Absolute Maximum Rating	Unit
		Red/Amber	
Forward Current	$I_F$	70	mA
Peak Forward Current <sup>Note</sup>	$I_{FP}$	200	mA
Reverse Voltage	$V_R$	5	V
Power Dissipation	$P_D$	210	mW
Operation Temperature	$T_{opr}$	-40 ~ +100	$^\circ\text{C}$
Storage Temperature	$T_{stg}$	-40 ~ +100	$^\circ\text{C}$
Junction Temperature	$T_J$	110	$^\circ\text{C}$
Junction/Ambient	$R_{THJA}$	300	$^\circ\text{C/W}$
Junction/Solder Point	$R_{THJS}$	150	$^\circ\text{C/W}$
Electrostatic Discharge Classification(MIL-STD-883E)	ESD	Class 2	

**Note:** Pulse width  $\leq 0.1$  msec, duty  $\leq 1/10$ .

## TYPICAL ELECTRICAL & OPTICAL CHARACTERISTICS ( $T_A = 25^\circ\text{C}$ )

Characteristics	Color	Symbol	Condition	Unit	Minimum	Typical	Maximum
Forward Voltage	Red/Amber	$V_F$	$I_F = 50$ mA	V		2.5	3.0
Reverse Current	Red/Amber	$I_R$	$V_R = 5$ V	$\mu\text{A}$			10
Dominant Wavelength	Red	$\lambda_D$	$I_F = 50$ mA	nm	618	624	630
	Amber	$\lambda_D$	$I_F = 50$ mA	nm	584	591	599
Luminous Intensity	Red	$I_V$	$I_F = 50$ mA	mcd	2240	3700	
	Amber	$I_V$	$I_F = 50$ mA	mcd	2800	5000	
50% Power Angle	Red/Amber	$2\theta_{1/2}$	$I_F = 50$ mA	deg		60	

### INTENSITY BIN LIMIT ( $I_F = 50 \text{ mA}$ )

Red (CLM2B-REW)

Bin Code	Min. (mcd)	Max. (mcd)
Xb	2240	2800
Ya	2800	3550
Yb	3550	4500
Z0	4500	5600

Amber (CLM2B-AEW)

Bin Code	Min. (mcd)	Max. (mcd)
Ya	2800	3550
Yb	3550	4500
Z0	4500	5600
A0	5600	7100
B0	7100	9000

Tolerance of measurement of luminous intensity is  $\pm 10\%$ .

### COLOR BIN LIMIT ( $I_F = 50 \text{ mA}$ )

Red (CLM2B-REW)

Bin Code	Min. (nm)	Max. (nm)
RA	618	630

Amber (CLM2B-AEW)

Bin Code	Min. (nm)	Max. (nm)
A2	584	587
A3	587	590
A4	590	593
A5	593	596
A6	596	599

Tolerance of measurement of dominant wavelength is  $\pm 1 \text{ nm}$ .

**ORDER CODE TABLE\***

Color	Kit Number	Viewing Angle	Luminous Intensity (mcd)		Dominant Wavelength			
			Min.	Max.	Color Bin	Min. (nm)	Color Bin	Max. (nm)
Red	CLM2B-REW-CXbZ0AA3	60	2240	5600	RA	618	RA	630
Red	CLM2B-REW-CYaZ0AA3	60	2800	5600	RA	618	RA	630
Red	CLM2B-REW-CYbZ0AA3	60	3550	5600	RA	618	RA	630

Color	Kit Number	Viewing Angle	Luminous Intensity (mcd)		Dominant Wavelength			
			Min.	Max.	Color Bin	Min. (nm)	Color Bin	Max. (nm)
Amber	CLM2B-AEW-CYaB0263	60	2800	9000	A2	584	A6	599
Amber	CLM2B-AEW-CYbB0263	60	3550	9000	A2	584	A6	599
Amber	CLM2B-AEW-CZ0B0353	60	4500	9000	A3	587	A5	596

Notes:

1. The above kit numbers represent order codes that include multiple intensity-bin and color-bin codes. Only one intensity-bin code and one color-bin code will be shipped on each bulk. Single intensity-bin code and single color-bin codes will not be orderable.
2. Please refer to the "Cree LED Lamp Reliability Test Standards" document for reliability test conditions.
3. Please refer to the "Cree LED Lamp Soldering & Handling" document for information about how to use this LED product safely.

GRAPHS

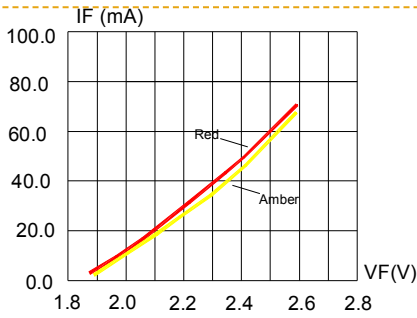

FIG.1 FORWARD CURRENT VS.

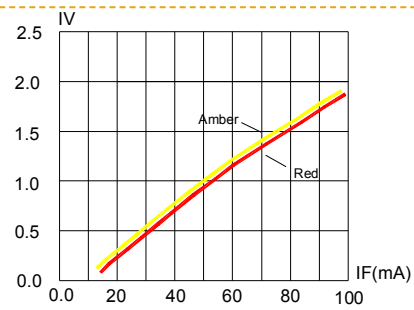

FIG.2 RELATIVE LUMINOUS INTENSITY VS. FORWARD CURRENT

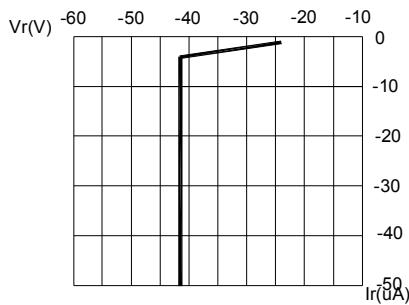

FIG.3 RED&AMBER REVERSE CURRENT VS. REVERSE VOLTAGE.

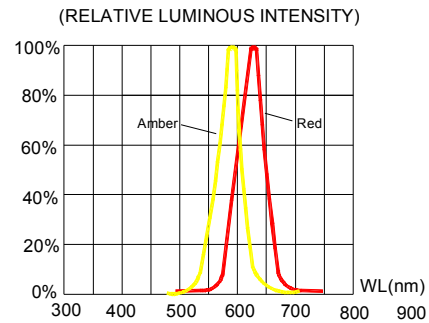

FIG.4 RELATIVE LUMINOUS INTENSITY VS. WAVELENGTH.

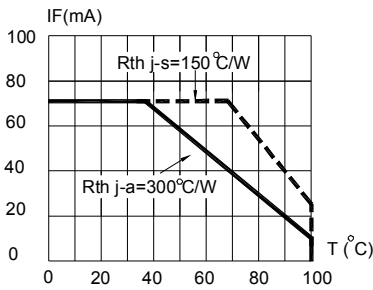

FIG.5 RED&AMBER MAXIMUM FORWARD DC CURRENT VS AMBIENT TEMPERATURE (Tjmax=110 $^{\circ}$ C)

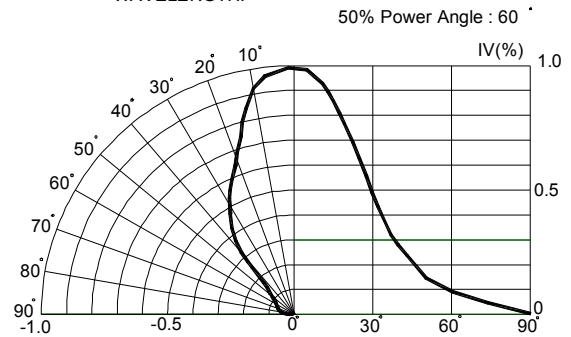
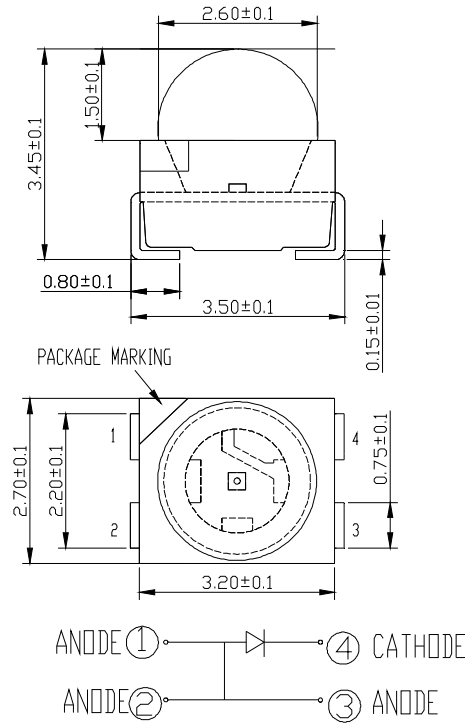

FIG.6 RED&AMBER FAR FIELD PATTERN

The above data are collected from statistical figures that do not necessarily correspond to the actual parameters of each single LED. Hence, these data will be changed without further notice.

## MECHANICAL DIMENSIONS

All dimensions are in mm.



## NOTES

### RoHS Compliance

The levels of environmentally sensitive, persistent biologically toxic (PBT), persistent organic pollutants (POP), or otherwise restricted materials in this product are below the maximum concentration values (also referred to as the threshold limits) permitted for such substances, or are used in an exempted application, in accordance with EU Directive 2002/95/EC on the restriction of the use of certain hazardous substances in electrical and electronic equipment (RoHS), as amended through April 21, 2006.

### Vision Advisory Claim

Users should be cautioned not to stare at the light of this LED product. The bright light can damage the eye.

**KIT NUMBER SYSTEM**

Cree LED lamps are tested and sorted into performance bins. A bin is specified by ranges of color, forward voltage, and brightness. Sorted LEDs are packaged for shipping in various convenient options. Please refer to the "Cree LED Lamp Packaging Standard" document for more information about shipping and packaging options.

Cree LEDs are sold by order codes in combinations of bins called kits. Order codes are configured in the following manner:



**PACKAGING**

- The boxes are not water resistant and they must be kept away from water and moisture.
- The LEDs are packed in cardboard boxes after packaging in normal or anti-electrostatic bags.
- Cardboard boxes will be used to protect the LEDs from mechanical shocks during transportation.
- The reel pack is applied in SMD LED.
- Max 700 pcs per reel.

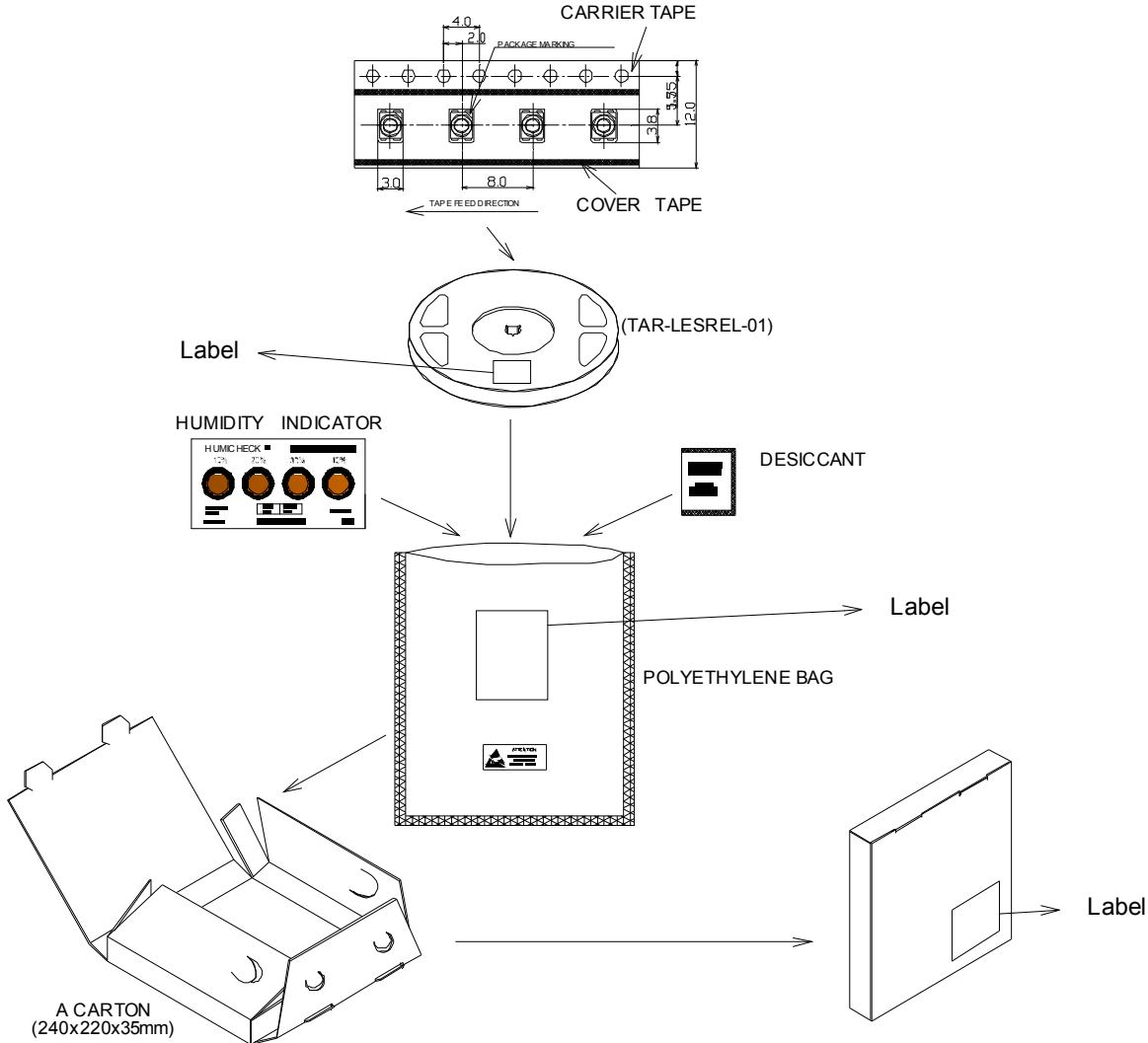





Компания «ЭлектроПласт» предлагает заключение долгосрочных отношений при поставках импортных электронных компонентов на взаимовыгодных условиях!

Наши преимущества:

- Оперативные поставки широкого спектра электронных компонентов отечественного и импортного производства напрямую от производителей и с крупнейших мировых складов;
- Поставка более 17-ти миллионов наименований электронных компонентов;
- Поставка сложных, дефицитных, либо снятых с производства позиций;
- Оперативные сроки поставки под заказ (от 5 рабочих дней);
- Экспресс доставка в любую точку России;
- Техническая поддержка проекта, помощь в подборе аналогов, поставка прототипов;
- Система менеджмента качества сертифицирована по Международному стандарту ISO 9001;
- Лицензия ФСБ на осуществление работ с использованием сведений, составляющих государственную тайну;
- Поставка специализированных компонентов (Xilinx, Altera, Analog Devices, Intersil, Interpoint, Microsemi, Aeroflex, Peregrine, Syfer, Eurofarad, Texas Instrument, Miteq, Cobham, E2V, MA-COM, Hittite, Mini-Circuits, General Dynamics и др.);

Помимо этого, одним из направлений компании «ЭлектроПласт» является направление «Источники питания». Мы предлагаем Вам помощь Конструкторского отдела:

- Подбор оптимального решения, техническое обоснование при выборе компонента;
- Подбор аналогов;
- Консультации по применению компонента;
- Поставка образцов и прототипов;
- Техническая поддержка проекта;
- Защита от снятия компонента с производства.



#### Как с нами связаться

**Телефон:** 8 (812) 309 58 32 (многоканальный)

**Факс:** 8 (812) 320-02-42

**Электронная почта:** [org@eplast1.ru](mailto:org@eplast1.ru)

**Адрес:** 198099, г. Санкт-Петербург, ул. Калинина, дом 2, корпус 4, литера А.