

Customer Information Sheet

DRAWING No.: M80-500000M2-XX-XXX-00-000

IF IN DOUBT - ASK

(C)

NOT TO SCALE

THIRD ANGLE PROJECTION

ALL DIMENSIONS IN mm

SPECIFICATIONS:

MATERIAL:
 MOULDING: GLASS FILLED PPS, UL94V-0, BLACK
COAX CONTACT:
 BODY, SLEEVE, INNER CONTACT, END PLUG = COPPER ALLOY
 LATCHING COLLAR = BERYLLIUM COPPER
 INSULATOR = PTFE
 JACKSCREW, NUT = STAINLESS STEEL
FINISH:
COAX CONTACT
 BODY, SLEEVE, INNER CONTACT, END PLUG = GOLD
 LATCHING COLLAR: = NICKEL
ELECTRICAL:
 INSULATION RESISTANCE = 100MΩ MIN
COAX CONTACT:
 FREQUENCY RANGE = 6GHz
 IMPEDANCE = 50Ω
 V.S.W.R = 1.05 + (0.04 x FREQUENCY) GHz MAX
 CONTACT RESISTANCE = 6mΩ MAX
 INSULATION RESISTANCE = 10⁶MΩ @250V AC
 OPERATING VOLTAGE = 180V AC @ 500mA
 MAXIMUM VOLTAGE = 1000V AC
MECHANICAL:
 DURABILITY = 500 OPERATIONS
COAX CONTACT:
 INSERTION FORCE = 8N MAX
 WITHDRAWAL FORCE = 0.5N MIN
ENVIRONMENTAL:
 TEMPERATURE RANGE = -55°C TO +125°C
PACKING:
 BAG
 FOR COMPLETE SPECIFICATION SEE COMPONENT SPECIFICATION C005XX (LATEST ISSUE)

COAX CRIMP/SOLDER CONTACTS ONLY

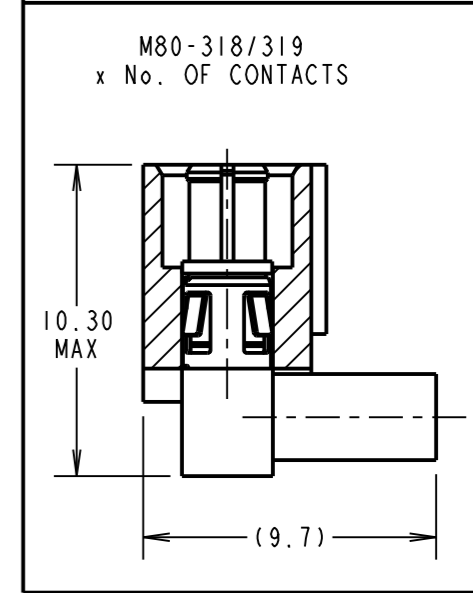
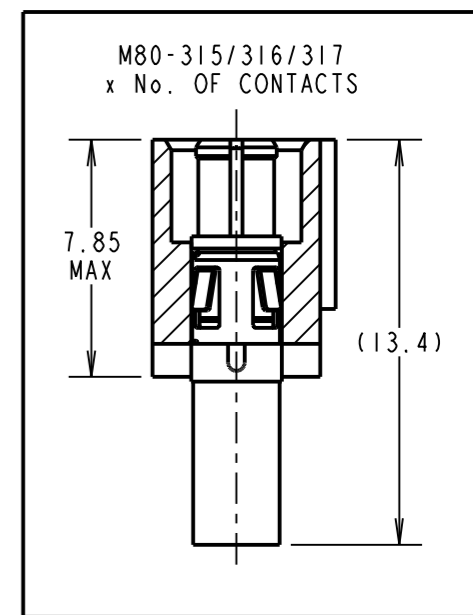
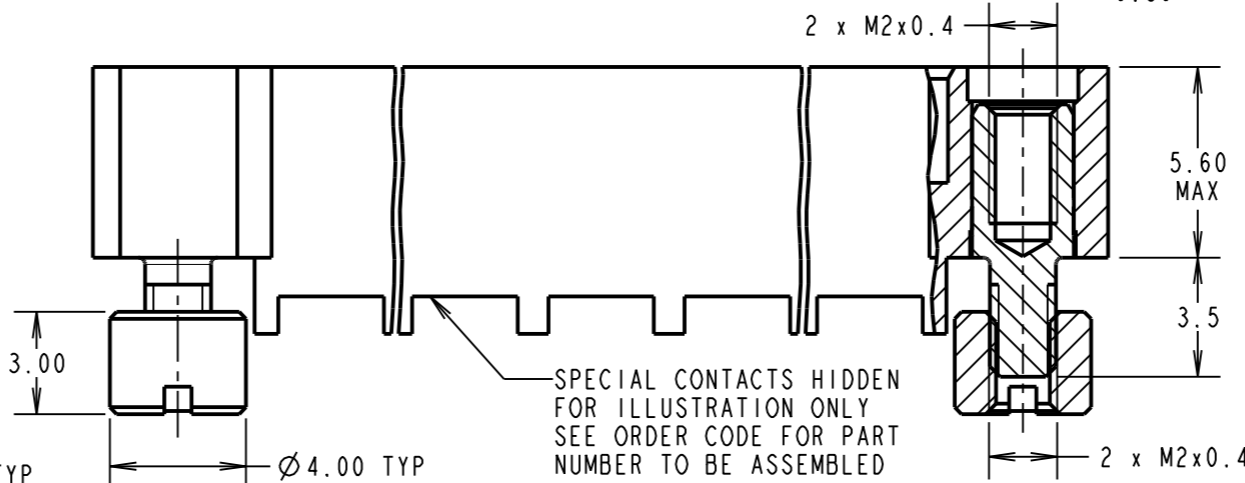
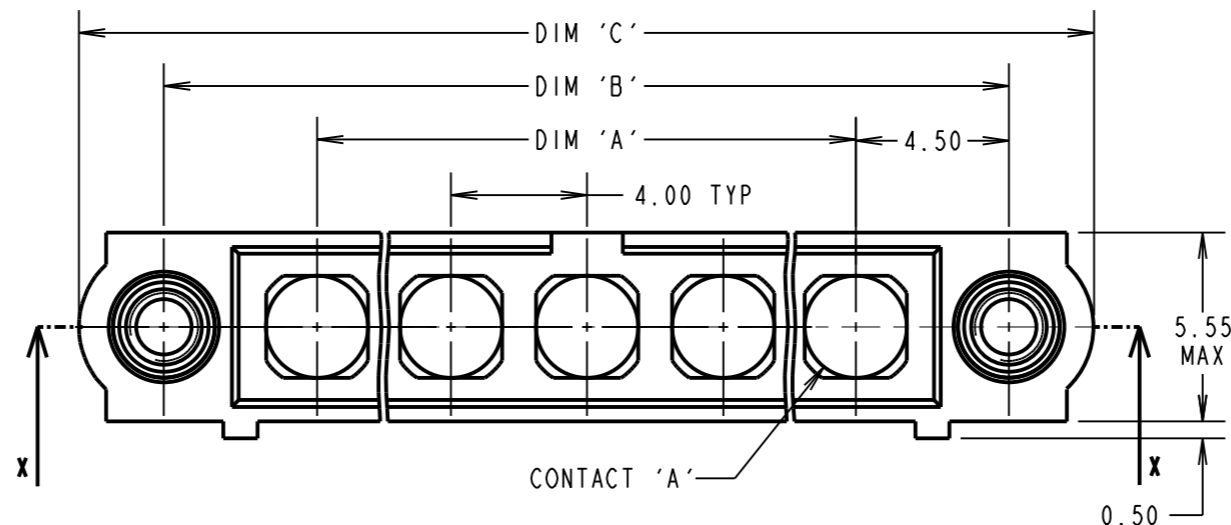

PART SECTION X-X

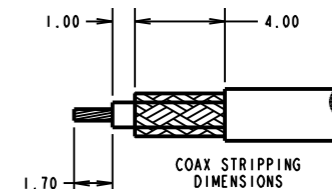
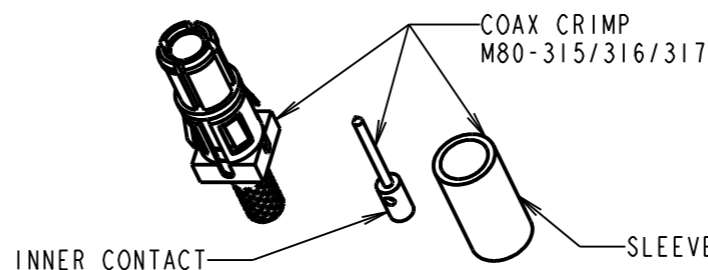
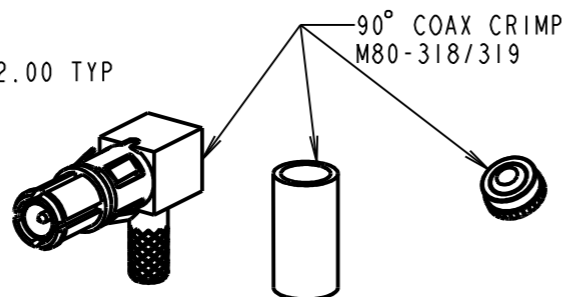
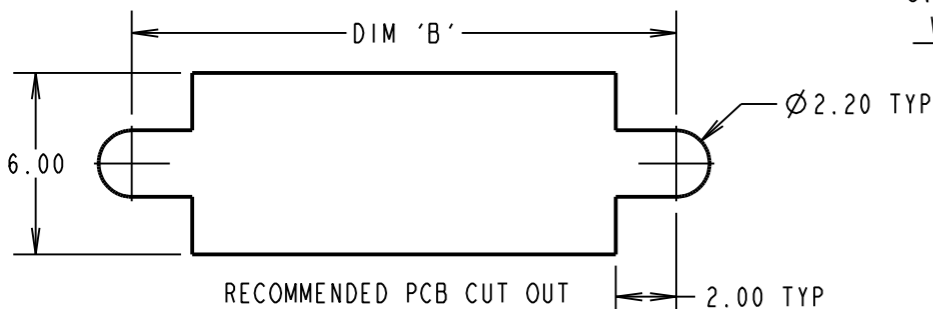

ORDER CODE: (COAX CRIMP/SOLDER CONTACTS)
M80-500000M2-XX-XXX-00-000

TOTAL No. OF CONTACTS
 02 TO 12

SPECIAL CONTACTS (CRIMP)
 315 = COAX CONTACT 2.0mm CRIMP M80-315
 316 = COAX CONTACT 2.4mm CRIMP M80-316
 317 = COAX CONTACT 2.7mm CRIMP M80-317
 318 = COAX CONTACT 2.0mm HORZ' CRIMP M80-318
 319 = COAX CONTACT 2.7mm HORZ' CRIMP M80-319

DIMENSION	CALCULATION
DIM 'A'	4 x No. OF CONTACTS - 4.00
DIM 'B'	4 x No. OF CONTACTS + 5.00
DIM 'C'	4 x No. OF CONTACTS + 10.00
EXAMPLE: CONNECTOR WITH 08 COAX CONTACTS, M80-500000M2-08-315-00-000 DIM 'A' = 28.00mm, DIM 'B' = 37.00mm, DIM 'C' = 42.00mm	

NOTES:

- CONNECTORS ARE SUPPLIED WITH CONTACTS LOOSE.
- COAX CONTACT IS SUPPLIED AS A KIT OF PARTS: BODY, MAIN INSULATOR, INNER CONTACT AND LATCHING COLLAR ARE PRE-ASSEMBLED AND SLEEVE AND INSULATED END PLUG ASSEMBLY ARE SEPARATE.
- FOR EXTRA COAX CONTACTS, USE PART NUMBERS M80-315/316/317/318/319.
- CONTACT EXTRACTION TOOL = Z80-290.
- RECOMMENDED HAND CRIMP TOOL FOR INNER COAX CONTACT = Z80-292 WITH POSITIONER Z80-291. RECOMMENDED HAND CRIMP TOOL AND DIE SET FOR SLEEVE = Z80-293.
- INSTRUCTION SHEETS ARE AVAILABLE.

MSP	7	11.08.15	12997
NAME	ISS.	DATE	C/NOTE
APPROVED:		M.PERREN	
CHECKED:		S.BENNETT	
DRAWN:		C.PENROSE	
CUSTOMER REF.:			
ASSEMBLY DRG:			

HARWIN

www.harwin.com
 technical@harwin.com

THIS DRAWING AND ANY INFORMATION OR DESCRIPTIVE MATTER SET OUT HEREON ARE CONFIDENTIAL AND COPYRIGHT PROPERTY OF THE HARWIN GROUP AND MUST NOT BE DISCLOSED, LOANED, COPIED OR USED FOR MANUFACTURING, TENDERING OR FOR ANY OTHER PURPOSE WITHOUT THEIR WRITTEN PERMISSION.

TOLERANCES
 X. = ±1mm
 X.X = ±0.50mm
 X.XX = ±0.10mm
 X.XXX = ±0.01mm
 ANGLES = ±5°
 UNLESS STATED

MATERIAL:
 SEE ABOVE
FINISH: SEE ABOVE
S/AREA: mm²

TITLE: DATAMATE MIX-TEK MALE ASSEMBLY WITH BOARD MOUNT J-SCREW
DRAWING NUMBER: M80-500000M2-XX-XXX-00-000
 SHT 4 OF 7

Customer Information Sheet

DRAWING No.: M80-500000M2-XX-XXX-00-000

IF IN DOUBT - ASK

(C)

NOT TO SCALE

THIRD ANGLE PROJECTION

ALL DIMENSIONS IN mm

SPECIFICATIONS:

MATERIAL:

MOULDING: GLASS FILLED PPS, UL94V-0, BLACK

POWER CONTACT:

BODY, SLEEVE, INNER CONTACT, END PLUG = COPPER ALLOY
 LATCHING COLLAR = BERYLLIUM COPPER
 INSULATOR = PTFE
 IOILOK RETAINER = STAINLESS STEEL

FINISH:

POWER CONTACT:
 BODY, SLEEVE, INNER CONTACT, END PLUG = GOLD
 LATCHING COLLAR = NICKEL

ELECTRICAL:

WORKING VOLTAGE = 800V AC/DC
 VOLTAGE PROOF = 1200V AC/DC
 INSULATION RESISTANCE = 100MΩ MIN

POWER CONTACT:

CONTACT RESISTANCE = 6mΩ MAX
 CURRENT RATING = M80-335 = 20A MAX WITH 12AWG
 M80-336 = 15A MAX WITH 14AWG
 M80-337 = 10A MAX WITH 16AWG
 M80-338 = 8A MAX WITH 18AWG
 M80-339 = 5A MAX WITH 20AWG
 M80-PM5 = 40A MAX WITH 10AWG
 CONTACT AS SPECIFIED

MECHANICAL:

DURABILITY = 500 OPERATIONS

POWER CONTACT:

INSERTION FORCE:
 M80-335/336/337/338/339 = 8N MAX
 M80-PM5 = 15N MAX
 WITHDRAWAL FORCE = 0.5N MIN

ENVIRONMENTAL:

TEMPERATURE RANGE:
 M80-335/336/337/338/339 = -55°C TO +125°C
 M80-PM5 = -55°C TO +150°C

PACKING:

BAG
 FOR COMPLETE SPECIFICATION SEE COMPONENT SPECIFICATION C005XX (LATEST ISSUE)

POWER CRIMP/SOLDER CONTACTS ONLY

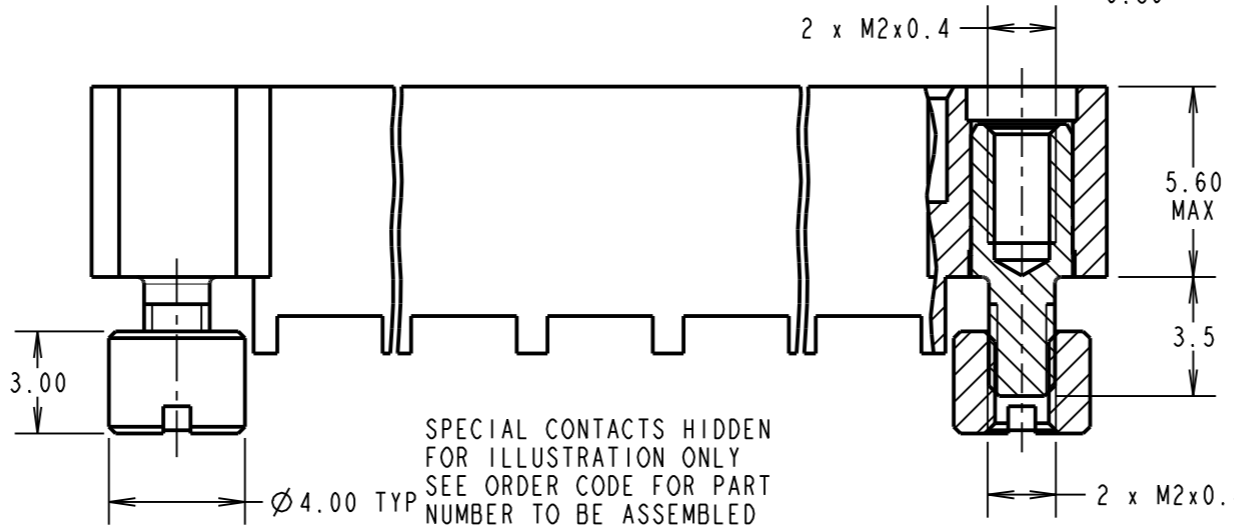
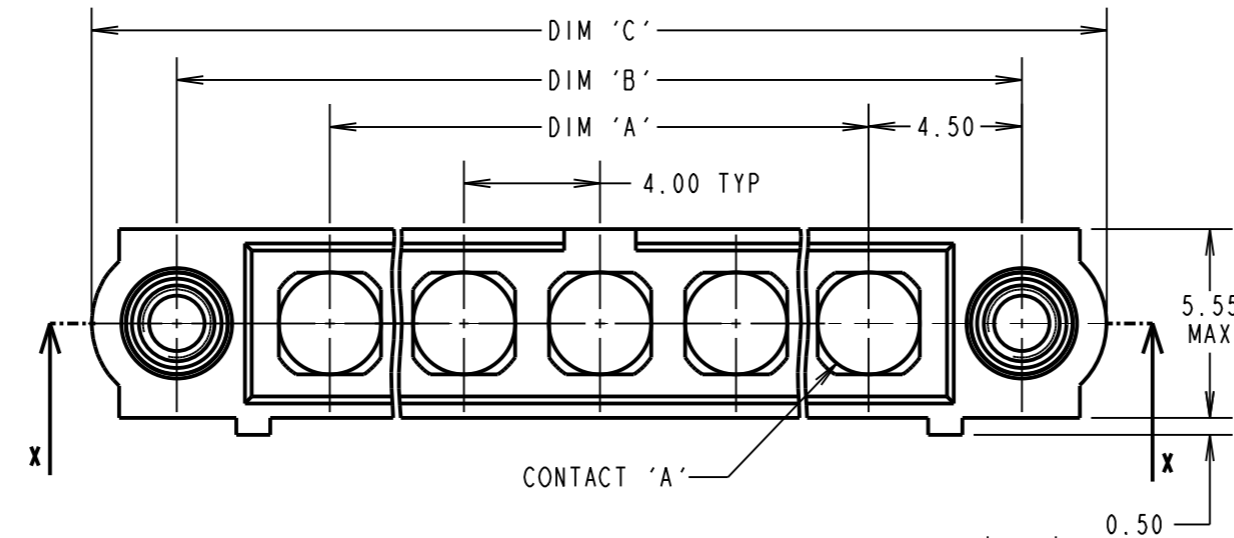

SPECIAL CONTACTS HIDDEN FOR ILLUSTRATION ONLY
 SEE ORDER CODE FOR PART NUMBER TO BE ASSEMBLED

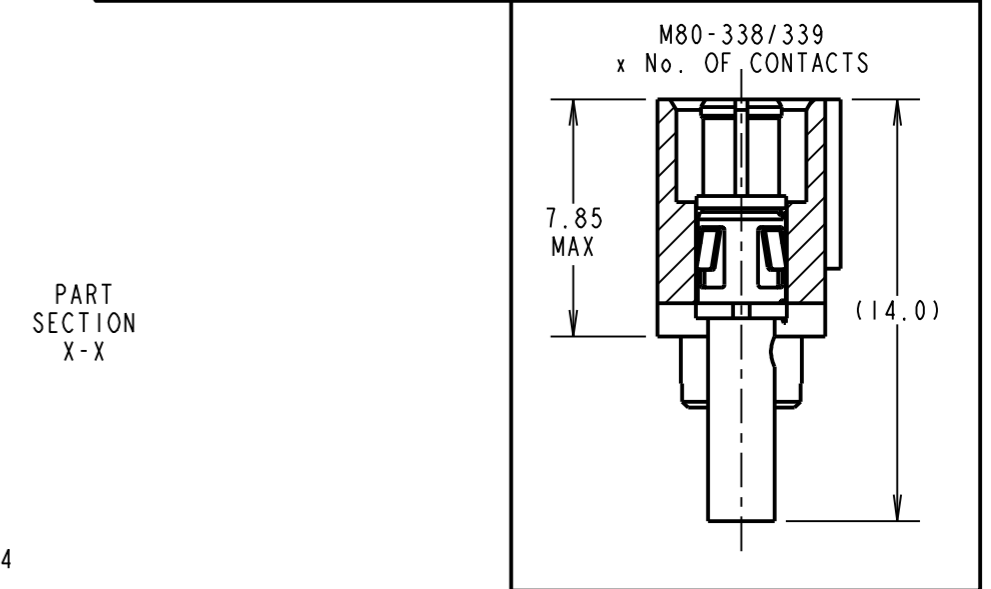
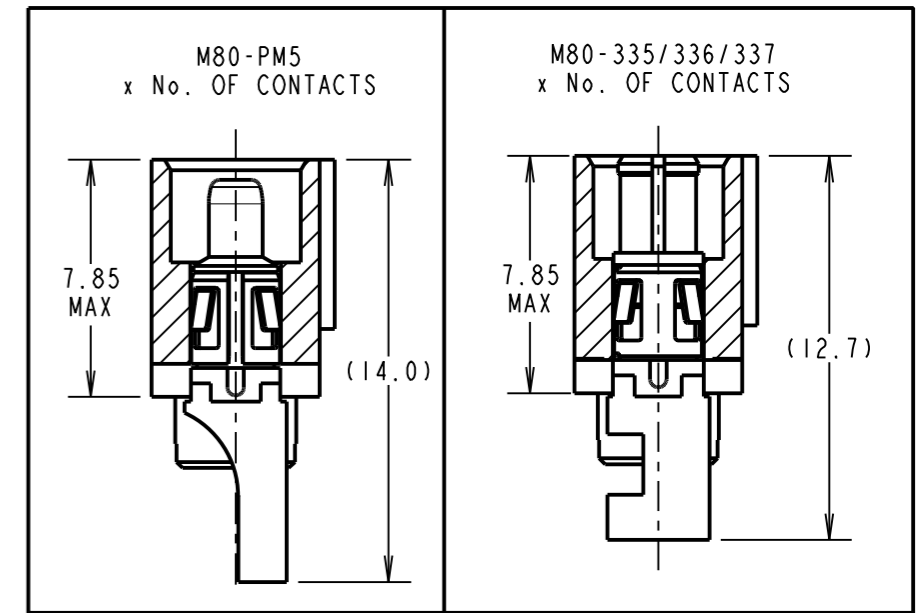

PART SECTION X-X

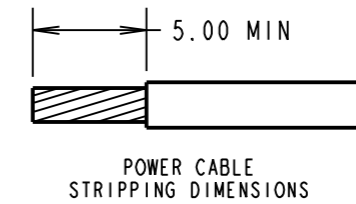

ORDER CODE: (POWER CRIMP/SOLDER CONTACTS)

M80-500000M2-XX-XXX-00-000

TOTAL No. OF CONTACTS _____
 02 TO 12

SPECIAL CONTACTS (CRIMP)

335 = POWER CONTACT 12AWG SOLDER M80-335
 336 = POWER CONTACT 14AWG SOLDER M80-336
 337 = POWER CONTACT 16AWG SOLDER M80-337
 338 = POWER CONTACT 18AWG SOLDER/CRIMP M80-338
 339 = POWER CONTACT 20AWG SOLDER/CRIMP M80-339
 PM5 = POWER CONTACT 10AWG SOLDER M80-PM5

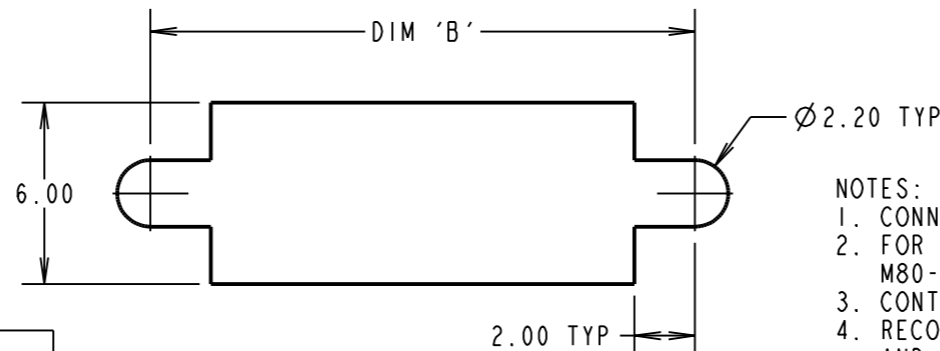

RECOMMENDED PCB CUT OUT

NOTES:

- CONNECTORS ARE SUPPLIED WITH CONTACTS LOOSE.
- FOR EXTRA POWER CONTACTS USE PART NUMBERS: M80-335/336/337/338/339/PF5.
- CONTACT EXTRACTION TOOL = Z80-290.
- RECOMMENDED HAND CRIMP TOOL FOR CONTACTS 338/339 = Z80-294 AND POSITIONER Z80-295.
- INSTRUCTION SHEETS ARE AVAILABLE.

DIMENSION	CALCULATION
DIM 'A'	4 x No. OF CONTACTS - 4.00
DIM 'B'	4 x No. OF CONTACTS + 5.00
DIM 'C'	4 x No. OF CONTACTS + 10.00
EXAMPLE: CONNECTOR WITH 10 POWER CONTACTS, M80-500000M2-10-335-00-000	
DIM 'A' = 36.00mm, DIM 'B' = 45.00mm, DIM 'C' = 50.00mm	

HARWIN

www.harwin.com
 technical@harwin.com

THIS DRAWING AND ANY INFORMATION OR DESCRIPTIVE MATTER SET OUT HEREON ARE CONFIDENTIAL AND COPYRIGHT PROPERTY OF THE HARWIN GROUP AND MUST NOT BE DISCLOSED, LOANED, COPIED OR USED FOR MANUFACTURING, TENDERING OR FOR ANY OTHER PURPOSE WITHOUT THEIR WRITTEN PERMISSION.

TOLERANCES

X. = ±1mm
 X.X = ±0.50mm
 X.XX = ±0.10mm
 X.XXX = ±0.01mm
 ANGLES = ±5°
 UNLESS STATED

MATERIAL:

SEE ABOVE

FINISH: SEE ABOVE

S/AREA:

mm²

TITLE: DATAMATE MIX-TEK
 MALE ASSEMBLY
 WITH BOARD MOUNT J-SCREW

DRAWING NUMBER:

M80-500000M2-XX-XXX-00-000

SHT
 5 OF 7

MSP	7	11.08.15	12997
NAME	ISS.	DATE	C/NOTE
APPROVED:		M.PERREN	
CHECKED:		S.BENNETT	
DRAWN:		C.PENROSE	
CUSTOMER REF.:			
ASSEMBLY DRG:			

Customer Information Sheet

DRAWING No.: M80-500000M2-XX-XXX-00-000

IF IN DOUBT - ASK

(C)

NOT TO SCALE

THIRD ANGLE PROJECTION

ALL DIMENSIONS IN mm

SPECIFICATIONS:

MATERIAL:
 MOULDING: GLASS FILLED PPS, UL94V-0, BLACK
 POWER CONTACT: COPPER ALLOY
 COAX CONTACT:
 BODY = COPPER ALLOY
 INNER CONTACT = COPPER ALLOY
 INSULATOR = PTFE
 IOILOK RETAINER = STAINLESS STEEL

FINISH:
 POWER CONTACT: GOLD
 COAX CONTACT: BODY, INNER CONTACT = GOLD

ELECTRICAL:
 WORKING VOLTAGE = 800V AC/DC
 VOLTAGE PROOF = 1200V AC/DC
 INSULATION RESISTANCE = 100MΩ MIN
 POWER CONTACT:
 CONTACT RESISTANCE = 6mΩ MAX
 CURRENT RATING:
 M80-311/312 = 20A MAX
 M80-331/332 = 20A MAX
 M80-PM1/PM2 = 40A MAX
 COAX CONTACT:
 FREQUENCY RANGE = 6GHz
 IMPEDANCE = 50Ω
 V.S.W.R = 1.05 + (0.04 x FREQUENCY) GHz MAX
 CONTACT RESISTANCE = 6mΩ MAX
 INSULATION RESISTANCE = 10⁶MΩ @250V AC
 OPERATING VOLTAGE = 180V AC @ 500mA
 MAXIMUM VOLTAGE = 1000V AC

MECHANICAL:
 DURABILITY = 500 OPERATIONS
 POWER CONTACT:
 INSERTION FORCE:
 M80-331/332 = 8N MAX
 M80-PM1/PM2 = 15N MAX
 WITHDRAWAL FORCE = 0.5N MIN
 COAX CONTACT:
 INSERTION FORCE = 8N MAX
 WITHDRAWAL FORCE = 0.5N MIN

ENVIRONMENTAL:
 TEMPERATURE RANGE:
 M80-311/312/331/332 = -55°C TO +125°C
 M80-PM1/PM2 = -55°C TO +150°C

PACKING:
 TUBE
 FOR COMPLETE SPECIFICATION SEE COMPONENT SPECIFICATION C005XX (LATEST ISSUE)

VERTICAL PC TAIL CONTACTS ONLY

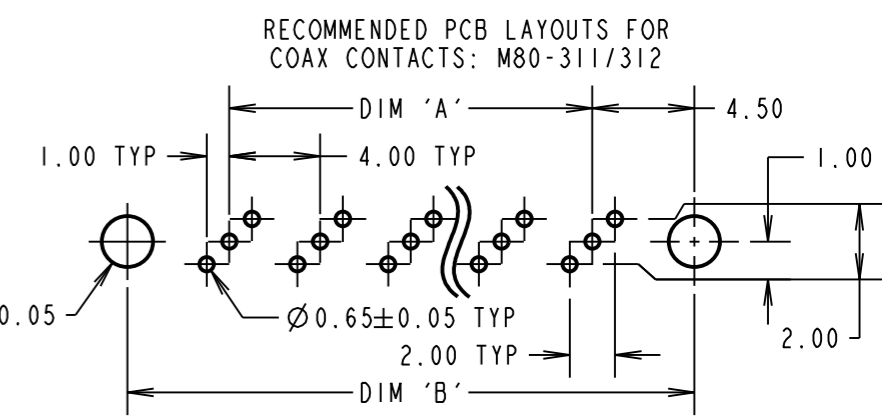
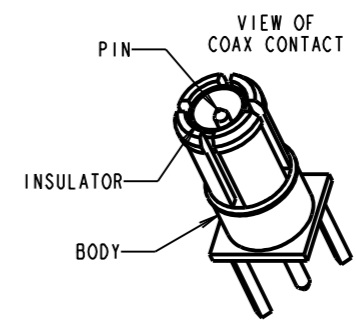
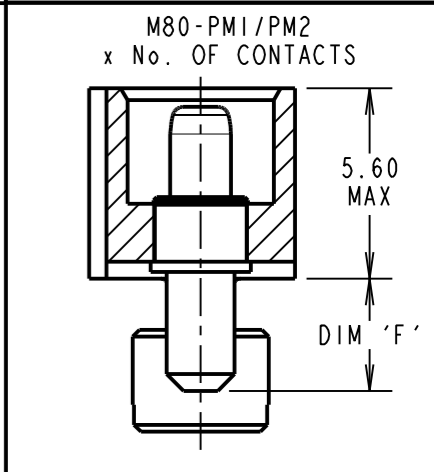
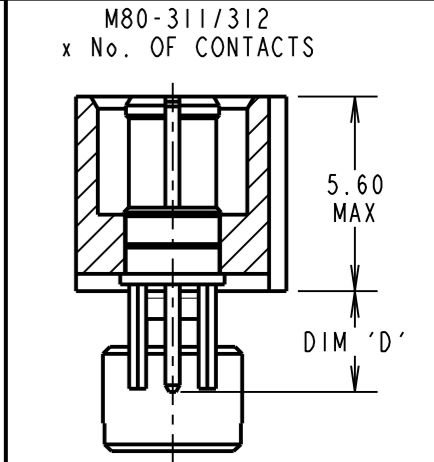
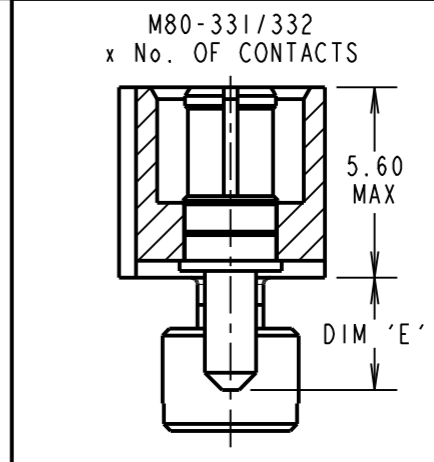
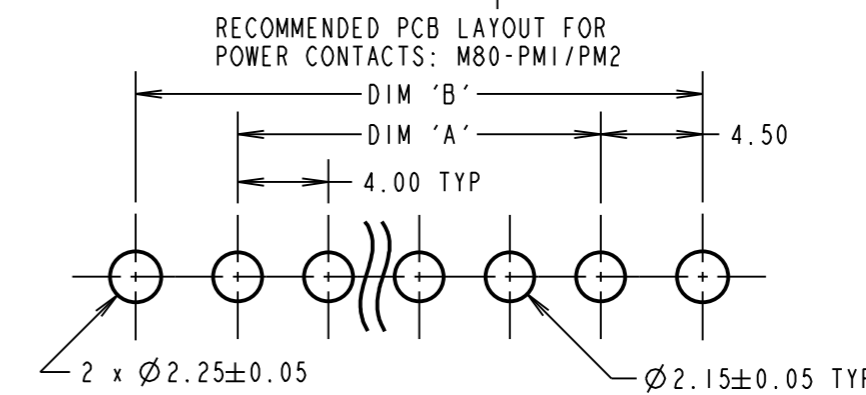
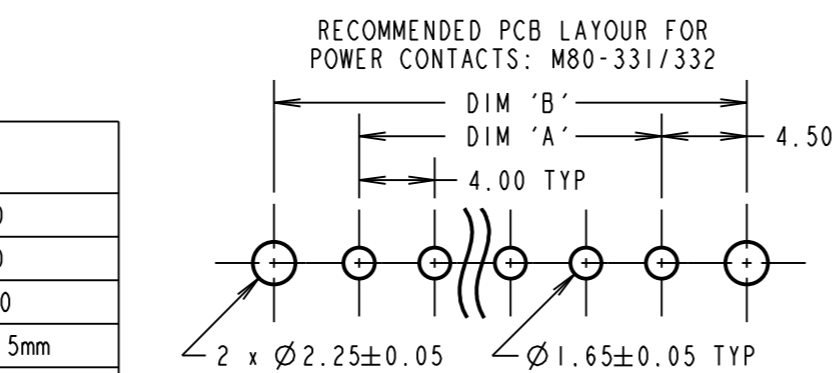
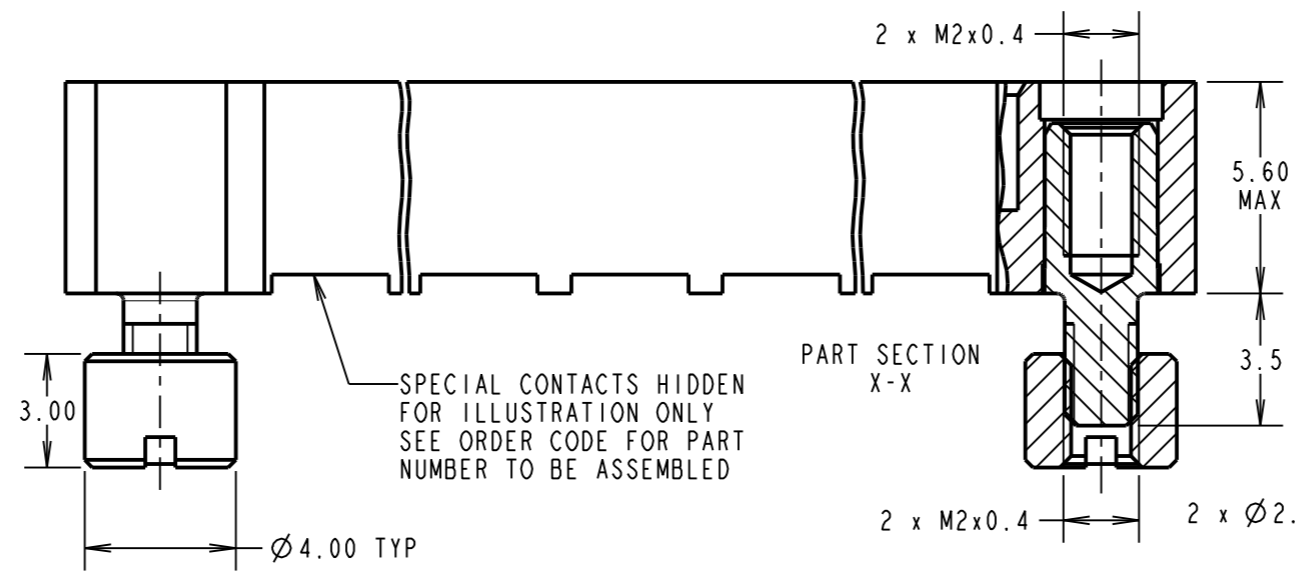
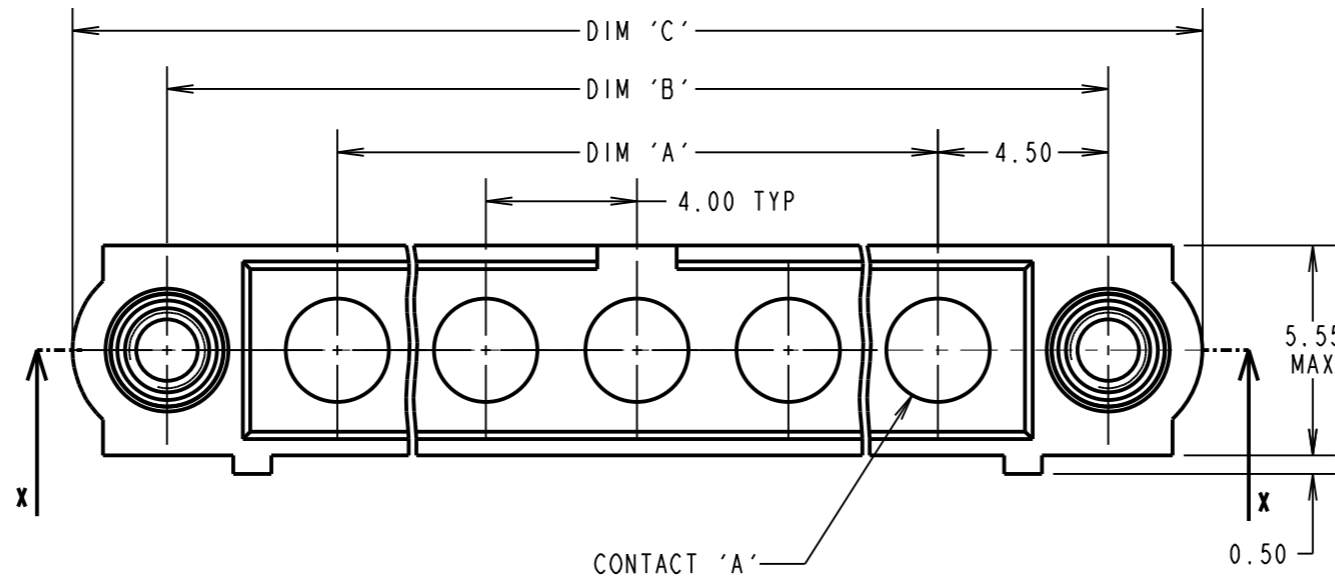

ORDER CODE: (COAX PC TAIL CONTACTS ONLY)
M80-500000M2-XX-XXX-00-000

TOTAL No. OF CONTACTS
 02 TO 12

SPECIAL CONTACTS (PC TAIL)
 311 = COAX CONTACT 3.0mm VERT' PC TAIL M80-311
 312 = COAX CONTACT 4.5mm VERT' PC TAIL M80-312
 331 = 20A POWER CONTACT 3.5mm VERT' PC TAIL M80-331
 332 = 20A POWER CONTACT 5.0mm VERT' PC TAIL M80-332
 PM1 = 40A POWER CONTACT 3.5mm VERT' PC TAIL M80-PM1
 PM2 = 40A POWER CONTACT 5.0mm VERT' PC TAIL M80-PM2

DIMENSION	CALCULATION
DIM 'A'	4 x No. OF CONTACTS - 4.00
DIM 'B'	4 x No. OF CONTACTS + 5.00
DIM 'C'	4 x No. OF CONTACTS + 10.00
DIM 'D'	M80-311 = 3.0mm, M80-312 = 4.5mm
DIM 'E'	M80-331 = 3.5mm, M80-332 = 5.0mm
DIM 'F'	M80-PM1 = 3.5mm, M80-PM2 = 5.0mm

EXAMPLE: CONNECTOR WITH 10 VERTICAL CONTACTS,
 M80-500000M2-10-332-00-000
 DIM 'A' = 36.00mm, DIM 'B' = 45.00mm, DIM 'C' = 50.00mm
 DIM 'D' = 5.0mm

HARWIN
 www.harwin.com
 technical@harwin.com

THIS DRAWING AND ANY INFORMATION OR DESCRIPTIVE MATTER SET OUT HEREON ARE CONFIDENTIAL AND COPYRIGHT PROPERTY OF THE HARWIN GROUP AND MUST NOT BE DISCLOSED, LOANED, COPIED OR USED FOR MANUFACTURING, TENDERING OR FOR ANY OTHER PURPOSE WITHOUT THEIR WRITTEN PERMISSION.

TOLERANCES
 X. = ±1mm
 X.X = ±0.50mm
 X.XX = ±0.10mm
 X.XXX = ±0.01mm
 ANGLES = ±5°
 UNLESS STATED

MATERIAL:
 SEE ABOVE
FINISH: SEE ABOVE
S/AREA: mm²

TITLE: DATAMATE MIX-TEK MALE ASSEMBLY WITH BOARD MOUNT J-SCREW
DRAWING NUMBER: M80-500000M2-XX-XXX-00-000
SHT 6 OF 7

MSP	7	11.08.15	12997
NAME	ISS.	DATE	C/NOTE
APPROVED:		M.PERREN	
CHECKED:		S.BENNETT	
DRAWN:		C.PENROSE	
CUSTOMER REF.:			
ASSEMBLY DRG:			



Компания «ЭлектроПласт» предлагает заключение долгосрочных отношений при поставках импортных электронных компонентов на взаимовыгодных условиях!

Наши преимущества:

- Оперативные поставки широкого спектра электронных компонентов отечественного и импортного производства напрямую от производителей и с крупнейших мировых складов;
- Поставка более 17-ти миллионов наименований электронных компонентов;
- Поставка сложных, дефицитных, либо снятых с производства позиций;
- Оперативные сроки поставки под заказ (от 5 рабочих дней);
- Экспресс доставка в любую точку России;
- Техническая поддержка проекта, помощь в подборе аналогов, поставка прототипов;
- Система менеджмента качества сертифицирована по Международному стандарту ISO 9001;
- Лицензия ФСБ на осуществление работ с использованием сведений, составляющих государственную тайну;
- Поставка специализированных компонентов (Xilinx, Altera, Analog Devices, Intersil, Interpoint, Microsemi, Aeroflex, Peregrine, Syfer, Eurofarad, Texas Instrument, Miteq, Cobham, E2V, MA-COM, Hittite, Mini-Circuits, General Dynamics и др.);

Помимо этого, одним из направлений компании «ЭлектроПласт» является направление «Источники питания». Мы предлагаем Вам помощь Конструкторского отдела:

- Подбор оптимального решения, техническое обоснование при выборе компонента;
- Подбор аналогов;
- Консультации по применению компонента;
- Поставка образцов и прототипов;
- Техническая поддержка проекта;
- Защита от снятия компонента с производства.



Как с нами связаться

Телефон: 8 (812) 309 58 32 (многоканальный)

Факс: 8 (812) 320-02-42

Электронная почта: org@eplast1.ru

Адрес: 198099, г. Санкт-Петербург, ул. Калинина, дом 2, корпус 4, литера А.