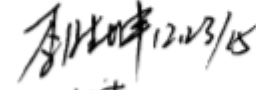
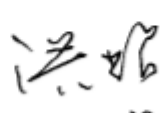
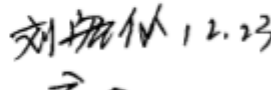

Product Specification

Product Name: VGM160128A3W03

Product Code: M01233

Customer
Approved by Customer
Approved Date:

Designed By	Checked By	Approved By	
		R&D	QA
 2015-12-23	 2015-12-23 刘青	 2015-12-23	 2015-12-23 高明

CONTENT

REVISION RECORD	3
1 OVERVIEW	4
2 FEATURES	4
3 MECHANICAL DATA	4
4 MECHANICAL DRAWING	5
5 MODULE INTERFACE	6
6 FUNCTION BLOCK DIAGRAM	8
7 ABSOLUTE MAXIMUM RATINGS	9
8 ELECTRICAL CHARACTERISTICS	9
8.1 DC ELECTRICAL CHARACTERISTICS	9
8.2 ELECTRO-OPTICAL CHARACTERISTICS	10
8.3 AC ELECTRICAL CHARACTERISTICS	11
9 FUNCTIONAL SPECIFICATION AND APPLICATION CIRCUIT	18
9.1 POWER ON/OFF SEQUENCE AND INITIALIZATION	18
9.2 APPLICATION CIRCUIT.....	20
9.3 EXTERNAL DC-DC APPLICATION CIRCUIT	25
9.4 DISPLAY CONTROL INSTRUCTION.....	26
9.5 RECOMMENDED SOFTWARE INITIALIZATION	26
10. PACKAGE SPECIFICATION	27
11. RELIABILITY	28
11.1 RELIABILITY TEST.....	28
11.2 LIFETIME.....	28
11.3 FAILURE CHECK STANDARD	28
12 ILLUSTRATION OF OLED PRODUCT NAME	29
13 OUTGOING QUALITY CONTROL SPECIFICATIONS	30
13.1 SAMPLING METHOD	30
13.2 INSPECTION CONDITIONS	30
13.3 QUALITY ASSURANCE ZONES.....	30
13.4 INSPECTION STANDARD.....	31
14 PRECAUTIONS FOR OPERATION AND STORAGE	34
14.1 PRECAUTIONS FOR OPERATION	34
14.2 SOLDERING	34
14.3 PRECAUTIONS FOR STORAGE.....	34
14.4 WARRANTY PERIOD	34

REVISION RECORD

REV.	REVISION DESCRIPTION	REV. DATE	REMARK
D01	Initial Release	2015-12-23	

1 Overview

VGM160128A3W03 is a monochrome OLED display module with 160×128 dot matrix. The characteristics of this display module are high brightness, self-emission, high contrast ratio, slim/thin outline, wide viewing angle, wide temperature range, and low power consumption.

2 Features

- Display Color: White
- Dot Matrix:160×128
- Driver IC: SH1108
- Interface: 8-bit 8080,8-bit 6800, 3-wire SPI, 4-wire SPI,I²C
- Wide range of operating temperature: -40°C to 70°C

3 Mechanical Data

NO.	ITEM	SPECIFICATION	UNIT
1	Dot Matrix	160(W)×128(H)	-
2	Dot Size	0.206(W)×0.226(H)	mm ²
3	Dot Pitch	0.226(W)×0.246(H)	mm ²
4	Aperture Rate	84	%
5	Active Area	28.908(W)×39.34(H)	mm ²
6	Panel Size	34.5(W) ×48.8(H) × 1.2(T)	mm ³
7	Module Size	34.5(W) ×118.8(H) × 1.2(T)	mm ³
8	Diagonal A/A Size	1.92	inch
9	Module Weight	4.25±10%	gram

4 Mechanical Drawing

如本印章非红色,则表明该文件为非受控版本,不会受到控制和更新,请使用受控文件.
分发号:

受控章

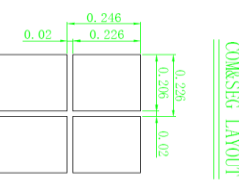
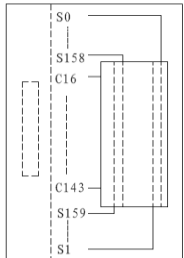
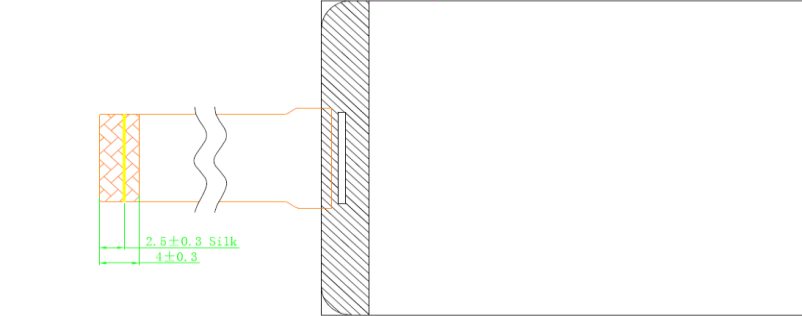
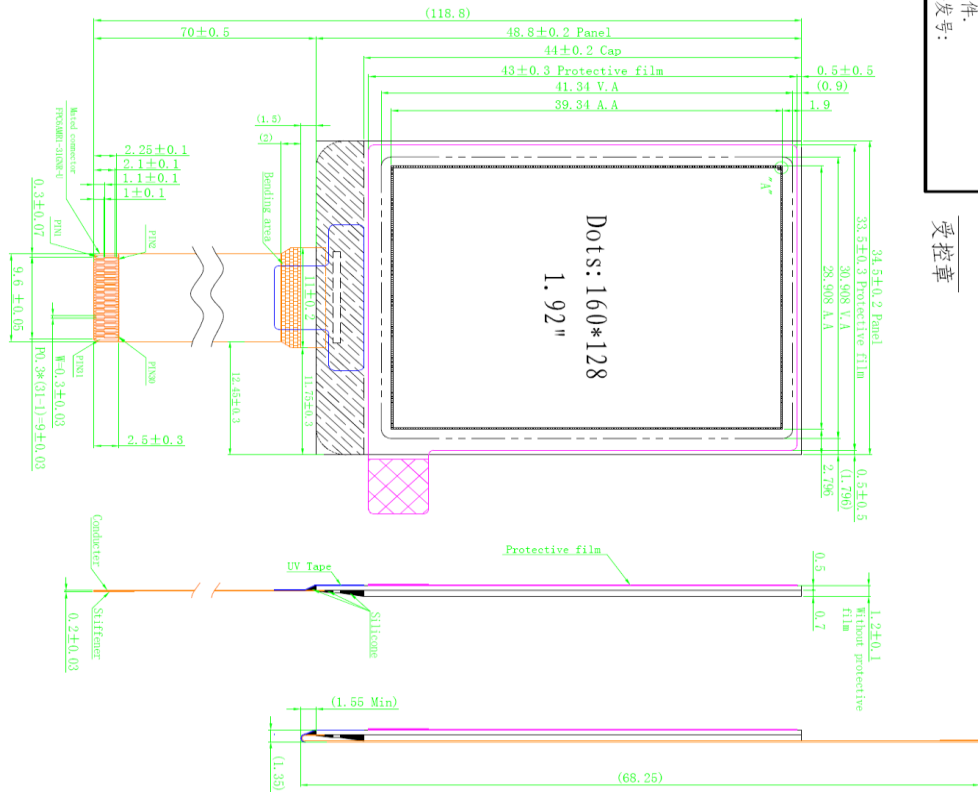

Detail "A" (30:1)

- Specification:**
1. Display: OLED (White)
 2. Format: 160*128
 3. Driver IC: SH1108
 4. General Tolerance: ± 0.3
 5. Operate Temp: $-40^{\circ}\text{C} \sim 70^{\circ}\text{C}$
 6. Storage Temp: $-40^{\circ}\text{C} \sim 85^{\circ}\text{C}$
 7. RoHS Compliant

Customer Approval Signature		Part Name		Date		Rev.		Unit		Sheet	
		Module Ass'y		2015.05.30		01		mm		1/1	
Project Code		DES'D BY		CHK'D BY		CHK'D BY		APPROVED		3rd Angle Projection	
Part No.		01233-MA1-A									

Rev.	Date	Note
1	2015.05.30	Based on01231:Modify the FPC
2		

Pin Assignment NO.	SYMBOL
1	NC
2	VPP
3	VSEGM
4	VCOMH
5	VSL
6	NC
7	REF
8	VPP
9	NC
10	VSS
11	VCL
12	VDD
13	IM0
14	IM1
15	VDD
16	IM2
17	/CS
18	/RES
19	A0
20	/WR
21	/RD
22	D0
23	D1
24	D2
25	D3
26	D4
27	D5
28	D6
29	D7
30	NC
31	VPP

5 Module Interface

PIN NO.	PIN NAME	DESCRIPTION																								
1、6、9、30	NC	No Connection.																								
2	VPP	This is the most positive voltage supply pad of the chip It should be supplied externally																								
3	VSEGM	This is a pad for the voltage output level for segment pre-charge. A capacitor should be connected between this pad and VSS.																								
4	VCOMH	This is a pad for the voltage output high level for common signals A capacitor should be connected between this pad and VSS																								
5	VSL	This is a segment voltage reference pad A capacitor should be connected between this pad and VSS																								
7	IREF	This is a segment current reference pad A resistor should be connected between this pad and VSS. Set the current at 15.625μ A																								
8	VPP	This is the most positive voltage supply pad of the chip It should be supplied externally																								
10	VSS	Ground for analog, logic&buffer respectively.																								
11	VCL	This is a common voltage reference pad This pad should be connected to VSS externally																								
12	VDD	1.65 - 3.5V power supply input pad for logic.																								
13	IM0	These are the MPU interface mode select pads.																								
		<table border="1"> <thead> <tr> <th></th> <th>8080</th> <th>I²C</th> <th>6800</th> <th>4-wire SPI</th> <th>3-wire SPI</th> </tr> </thead> <tbody> <tr> <td>IM0</td> <td>0</td> <td>0</td> <td>0</td> <td>0</td> <td>1</td> </tr> <tr> <td>IM1</td> <td>1</td> <td>1</td> <td>0</td> <td>0</td> <td>0</td> </tr> <tr> <td>IM2</td> <td>1</td> <td>0</td> <td>1</td> <td>0</td> <td>0</td> </tr> </tbody> </table>		8080	I ² C	6800	4-wire SPI	3-wire SPI	IM0	0	0	0	0	1	IM1	1	1	0	0	0	IM2	1	0	1	0	0
	8080	I ² C	6800	4-wire SPI	3-wire SPI																					
IM0	0	0	0	0	1																					
IM1	1	1	0	0	0																					
IM2	1	0	1	0	0																					
14	IM1																									
16	IM2																									
15	VDD	1.65 - 3.5V power supply input pad																								
17	/CS	This pad is the chip select input. When /CS = "L", then the chip select becomes active, and data/command I/O is enabled.																								
18	/RES	This is a reset signal input pad. When /RES is set to "L", the settings are initialized. The reset operation is performed by the /RES signal level.																								
19	A0	This is the Data/Command control pad that determines whether the data bits are data or a command. A0 = "H": the inputs at D0 to D7 are treated as display data. A0 = "L": the inputs at D0 to D7 are transferred to the command registers. In I ² C interface, this pad serves as SA0 to distinguish the different address of OLED driver.																								
20	/WR	This is a MPU interface input pad. When connected to an 8080 MPU, this is active LOW. This pad connects to the 8080 MPU /WR signal. The signals on the data bus are latched at the rising edge of the /WR signal. When connected to a 6800 Series MPU: This is the read/write control signal input terminal. When /WR = "H": Read. When /WR = "L": Write.																								

21	/RD	This is a MPU interface input pad. When connected to an 8080 series MPU, it is active LOW. This pad is connected to the /RD signal of the 8080 series MPU, and the data bus is in an output status when this signal is "L". When connected to a 6800 series MPU, this is active HIGH. This is used as an enable clock input of the 6800 series MPU.
22~29	D0~D7	Data bus.
31	VPP	This is the most positive voltage supply pad of the chip It should be supplied externally

6 Function Block Diagram

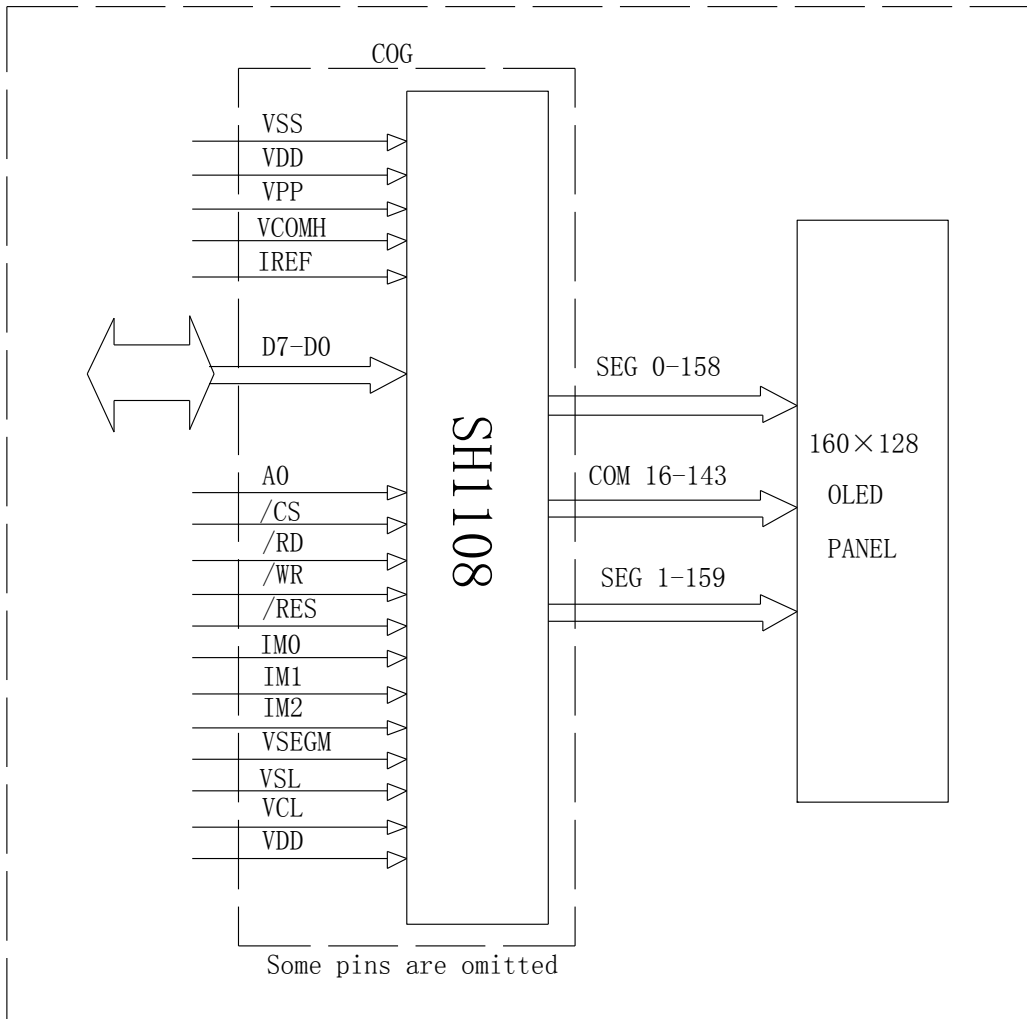

7 Absolute Maximum Ratings

ITEM	SYMBOL	MIN	MAX	UNIT	REMARK
Supply voltage	VDD	-0.3	3.6	V	IC maximum rating
	VPP	-0.3	17	V	IC maximum rating
Operating Temp.	Top	-40	70	°C	-
Storage Temp	Tstg	-40	85	°C	-

Note (1): All of the voltages are on the basis of “GND = 0V”.

Note (2): Permanent breakage of module may occur if the module is used beyond the maximum rating. The module can be normal operated under the conditions according to Section 8 “Electrical Characteristics”. Malfunctioning of the module may occur and the reliability of the module may deteriorate if the module is used beyond the conditions.

8 Electrical Characteristics

8.1 DC Electrical Characteristics

ITEM	SYMBOL	TEST CONDITION	MIN	TYP	MAX	UNIT
Operating Voltage	VPP	-	13	13.5	14	V
Logic Supply Voltage	VDD	-	1.65	3.0	3.5	V
High-level Output voltage	V_{OH}	$I_{OH} = -0.5\text{mA}$ (D0-D7, and CL)	$0.8 \times VDD$	-	VDD	V
Low-level Output voltage	V_{OL}	$I_{OL} = 0.5\text{mA}$ (D0, D2-D7, and CL)	VSS	-	$0.2 \times VDD$	V
High Logic Input voltage	V_{IH}	A0, D0 - D7, RD(E), WR (R/W), CS, CLS, CL, IM0~2 and RES.	$0.8 \times VDD$	-	VDD	V
Low Logic Input voltage	V_{IL}		VSS	-	$0.2 \times VDD$	V

8.2 Electro-optical Characteristics

ITEM	SYMBOL	TEST CONDITION	MIN	TYP	MAX	UNIT
Normal Mode Brightness	L _{br}	All pixels ON(1)	230	280	-	cd/m ²
VDD Sleep mode Current	ISP_VDD	VDD=2.8V,VPP=OFF Display OFF, No panel attached	-	0.02	10	uA
VPP Sleep mode Current	ISP_VPP	VDD=2.8V,VPP=7-16.5V Display OFF, No panel attached	-	0.02	10	uA
Normal Mode Power Consumption	Pt	All pixels ON(1)	-	796.5	945	mW
C.I.E(White)	(x)	x,y(CIE1931)	0.32	0.36	0.40	-
	(y)		0.34	0.38	0.42	-
Dark Room Contrast	CR	-	≥2000:1	-	-	-
Response Time	-	-	---	10	-	μ s
View Angle	-	-	≥160	-	-	Degree

Note(1): Normal Mode test conditions are as follows:

- Driving voltage : 13.5V
- Contrast setting : 0xD0
- Frame rate : 100Hz
- Duty setting : 1/128

8.3 AC Electrical Characteristics

(1) System buses Read/Write characteristics 1 (For the 8080 Series Interface MPU)

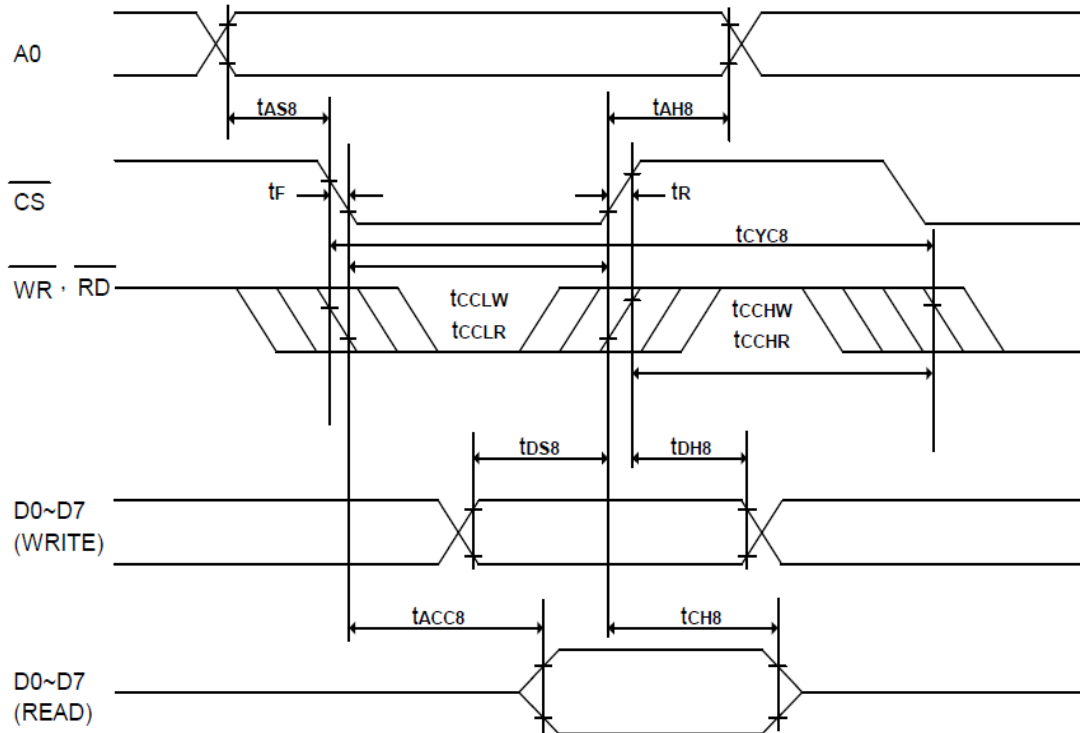

(VDD = 1.65V – 2.4V, TA = +25°C)

Symbol	Parameter	Min.	Typ.	Max.	Unit	Condition
tcyc8	System cycle time	300	-	-	ns	
tas8	Address setup time	0	-	-	ns	
tah8	Address hold time	0	-	-	ns	
tDS8	Data setup time	40	-	-	ns	
tDH8	Data hold time	30	-	-	ns	
tCH8	Output disable time	10	-	70	ns	CL = 100pF
tACC8	\overline{RD} access time	-	-	280	ns	CL = 100pF
tcCLW	Control L pulse width (WR)	100	-	-	ns	
tcCLR	Control L pulse width (RD)	120	-	-	ns	
tcCHW	Control H pulse width (WR)	100	-	-	ns	
tcCHR	Control H pulse width (RD)	100	-	-	ns	
tR	Rise time	-	-	15	ns	
tF	Fall time	-	-	15	ns	

(VDD = 2.4V – 3.5V, TA = +25°C)

Symbol	Parameter	Min.	Typ.	Max.	Unit	Condition
tCYC8	System cycle time	300	-	-	ns	
tAS8	Address setup time	0	-	-	ns	
tAH8	Address hold time	0	-	-	ns	
tDS8	Data setup time	40	-	-	ns	
tDH8	Data hold time	15	-	-	ns	
tCH8	Output disable time	10	-	70	ns	CL = 100pF
tACC8	\overline{RD} access time	-	-	140	ns	CL = 100pF
tcCLW	Control L pulse width (WR)	100	-	-	ns	
tcCLR	Control L pulse width (RD)	120	-	-	ns	
tcCHW	Control H pulse width (WR)	100	-	-	ns	
tcCHR	Control H pulse width (RD)	100	-	-	ns	
tR	Rise time	-	-	15	ns	
tF	Fall time	-	-	15	ns	

(2) System buses Read/Write characteristics 2 (For the 6800 Series Interface MPU)

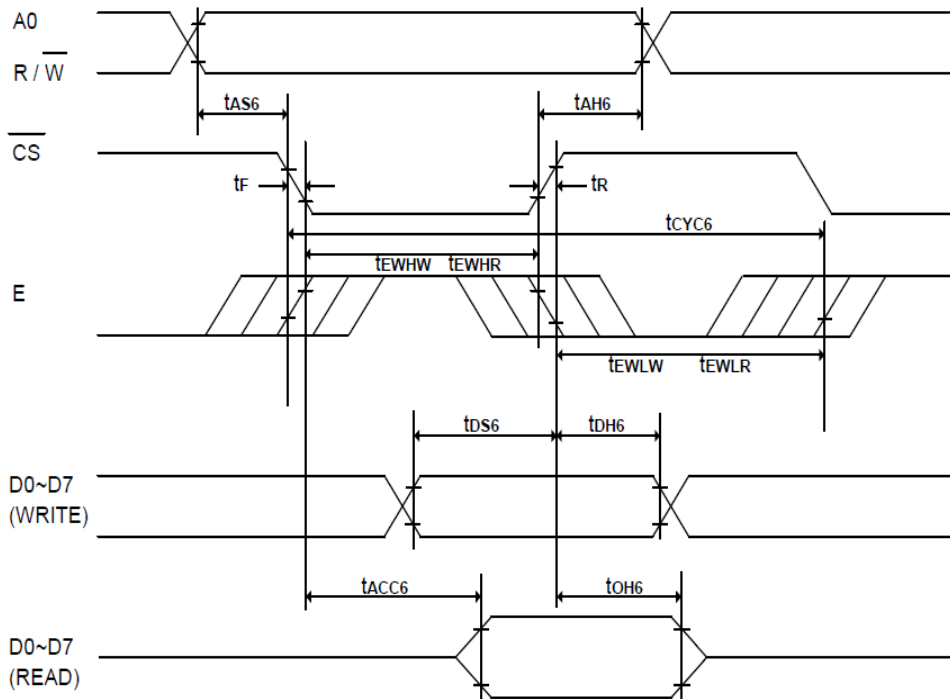

(VDD = 1.65 – 2.4V, TA = +25°C)

Symbol	Parameter	Min.	Typ.	Max.	Unit	Condition
tCYC6	System cycle time	300	-	-	ns	
tAS6	Address setup time	0	-	-	ns	
tAH6	Address hold time	0	-	-	ns	
tDS6	Data setup time	40	-	-	ns	
tDH6	Data hold time	30	-	-	ns	
tOH6	Output disable time	10	-	70	ns	CL = 100pF
tACC6	Access time	-	-	280	ns	CL = 100pF
tEWHW	Enable H pulse width (Write)	100	-	-	ns	
tEWHR	Enable H pulse width (Read)	120	-	-	ns	
tEWLW	Enable L pulse width (Write)	100	-	-	ns	
tEWLR	Enable L pulse width (Read)	100	-	-	ns	
tR	Rise time	-	-	15	ns	
tF	Fall time	-	-	15	ns	

(VDD = 2.4 – 3.5V, TA = +25°C)

Symbol	Parameter	Min.	Typ.	Max.	Unit	Condition
tCYC6	System cycle time	300	-	-	ns	
tAS6	Address setup time	0	-	-	ns	
tAH6	Address hold time	0	-	-	ns	
tDS6	Data setup time	40	-	-	ns	
tDH6	Data hold time	15	-	-	ns	
tOH6	Output disable time	10	-	70	ns	CL = 100pF
tACC6	Access time	-	-	140	ns	CL = 100pF
tEWHW	Enable H pulse width (Write)	100	-	-	ns	
tEWHR	Enable H pulse width (Read)	120	-	-	ns	
tEWLW	Enable L pulse width (Write)	100	-	-	ns	
tEWLR	Enable L pulse width (Read)	100	-	-	ns	
tR	Rise time	-	-	15	ns	
tF	Fall time	-	-	15	ns	

(3)System buses Write characteristics 3 (For 4 wire SPI)

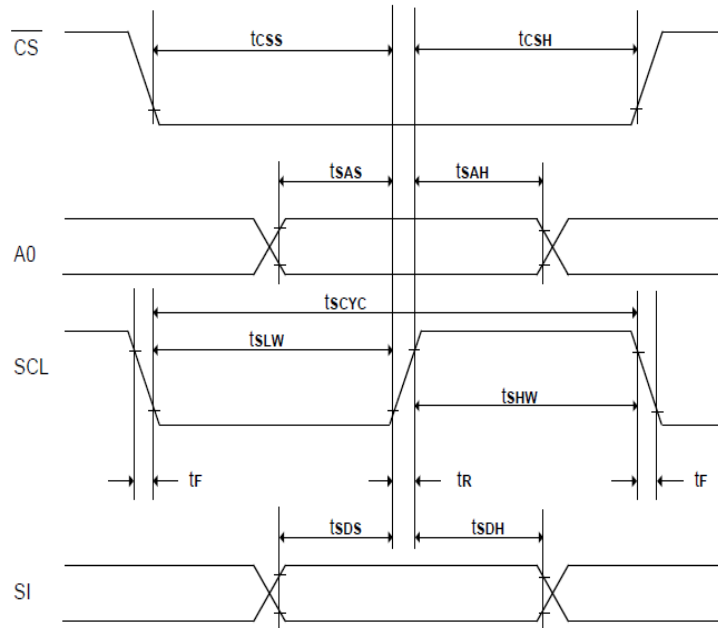

(VDD1 = 1.65 – 2.4V, TA = +25°C)

Symbol	Parameter	Min.	Typ.	Max.	Unit	Condition
t _{sCYC}	Serial clock cycle	500	-	-	ns	
t _{sAS}	Address setup time	300	-	-	ns	
t _{sAH}	Address hold time	300	-	-	ns	
t _{sDS}	Data setup time	200	-	-	ns	
t _{sDH}	Data hold time	200	-	-	ns	
t _{CSS}	\overline{CS} setup time	240	-	-	ns	
t _{CSH}	\overline{CS} hold time time	120	-	-	ns	
t _{sHW}	Serial clock H pulse width	200	-	-	ns	
t _{sLW}	Serial clock L pulse width	200	-	-	ns	
t _R	Rise time	-	-	30	ns	
t _F	Fall time	-	-	30	ns	

(VDD1 = 2.4 - 3.5V, TA = +25°C)

Symbol	Parameter	Min.	Typ.	Max.	Unit	Condition
t _{sCYC}	Serial clock cycle	250	-	-	ns	
t _{sAS}	Address setup time	150	-	-	ns	
t _{sAH}	Address hold time	150	-	-	ns	
t _{sDS}	Data setup time	100	-	-	ns	
t _{sDH}	Data hold time	100	-	-	ns	
t _{CSS}	\overline{CS} setup time	120	-	-	ns	
t _{CSH}	\overline{CS} hold time time	60	-	-	ns	
t _{sHW}	Serial clock H pulse width	100	-	-	ns	
t _{sLW}	Serial clock L pulse width	100	-	-	ns	
t _R	Rise time	-	-	15	ns	
t _F	Fall time	-	-	15	ns	

(4)System buses Write characteristics 4 (For 3 wire SPI)

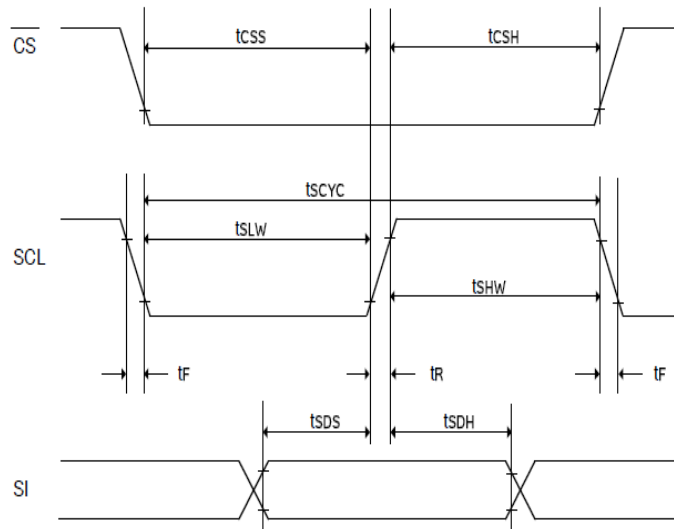

(V_{DD1} = 1.65 – 2.4V, T_A = +25°C)

Symbol	Parameter	Min.	Typ.	Max.	Unit	Condition
t _{SCYC}	Serial clock cycle	500	-	-	ns	
t _{SDS}	Data setup time	200	-	-	ns	
t _{SDH}	Data hold time	200	-	-	ns	
t _{CSS}	\overline{CS} setup time	240	-	-	ns	
t _{CSH}	\overline{CS} hold time time	120	-	-	ns	
t _{SHW}	Serial clock H pulse width	200	-	-	ns	
t _{SLW}	Serial clock L pulse width	200	-	-	ns	
t _R	Rise time	-	-	30	ns	
t _F	Fall time	-	-	30	ns	

(V_{DD1} = 2.4 - 3.5V, T_A = +25°C)

Symbol	Parameter	Min.	Typ.	Max.	Unit	Condition
t _{SCYC}	Serial clock cycle	250	-	-	ns	
t _{SDS}	Data setup time	100	-	-	ns	
t _{SDH}	Data hold time	100	-	-	ns	
t _{CSS}	\overline{CS} setup time	120	-	-	ns	
t _{CSH}	\overline{CS} hold time time	60	-	-	ns	
t _{SHW}	Serial clock H pulse width	100	-	-	ns	
t _{SLW}	Serial clock L pulse width	100	-	-	ns	
t _R	Rise time	-	-	15	ns	
t _F	Fall time	-	-	15	ns	

(5) I²C Interface Characteristics

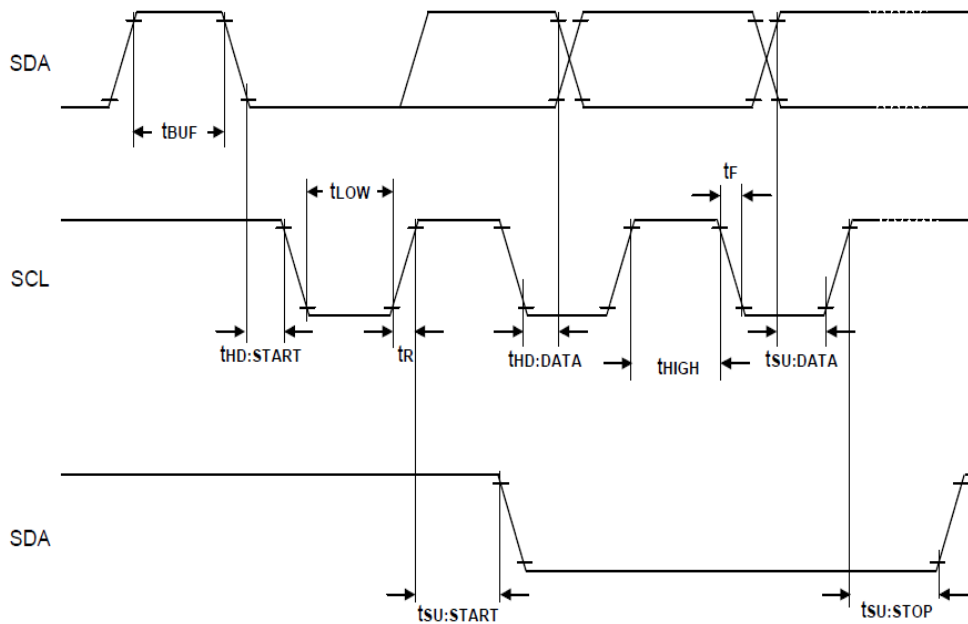

(V_{DD} = 1.65 - 3.5V, T_A = +25°C)

Symbol	Parameter	Min.	Typ.	Max.	Unit	Condition
f _{SCL}	SCL clock frequency	DC	-	400	kHz	
T _{LOW}	SCL clock Low pulse width	1.3	-	-	s	
T _{HIGH}	SCL clock H pulse width	0.6	-	-	s	
T _{SU:DATA}	data setup time	100	-	-	ns	
T _{HD:DATA}	data hold time	0	-	0.9	s	
T _R	SCL, SDA rise time	20+0.1Cb	-	300	ns	
T _F	SCL, SDA fall time	20+0.1Cb	-	300	ns	
C _b	Capacity load on each bus line	-	-	400	pF	
T _{SU:START}	Setup time for re-START	0.6	-	-	s	
T _{HD:START}	START Hold time	0.6	-	-	s	
T _{SU:STOP}	Setup time for STOP	0.6	-	-	s	
T _{BUF}	Bus free times between STOP and START condition	1.3	-	-	s	

9 Functional Specification and Application Circuit

9.1 Power ON/OFF Sequence and Initialization

Power on sequence:

External power is being used immediately after turning on the power:

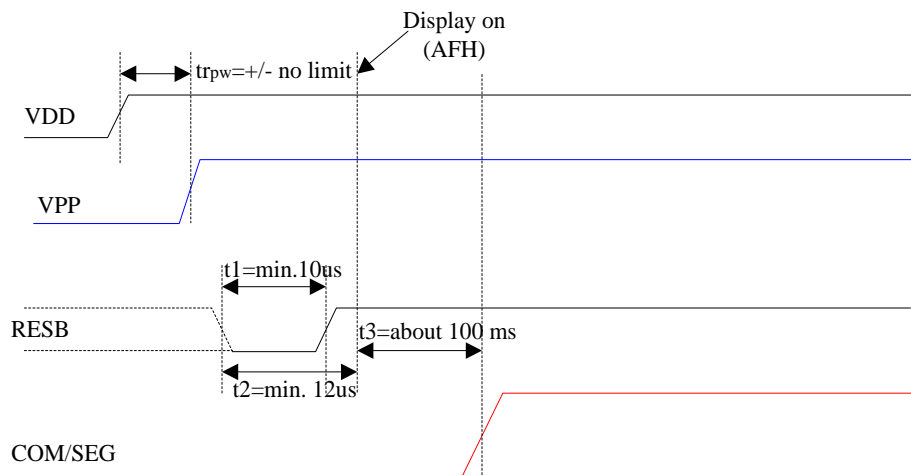
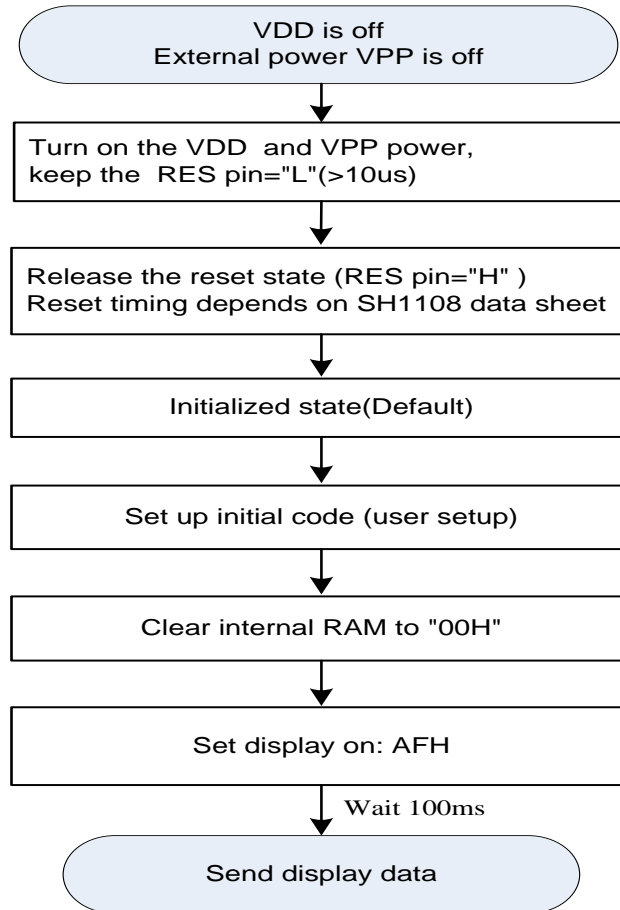

Power off sequence:

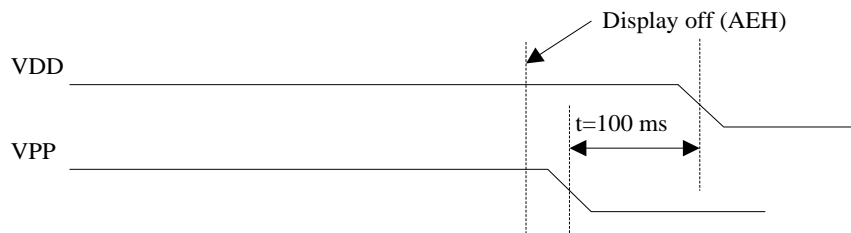
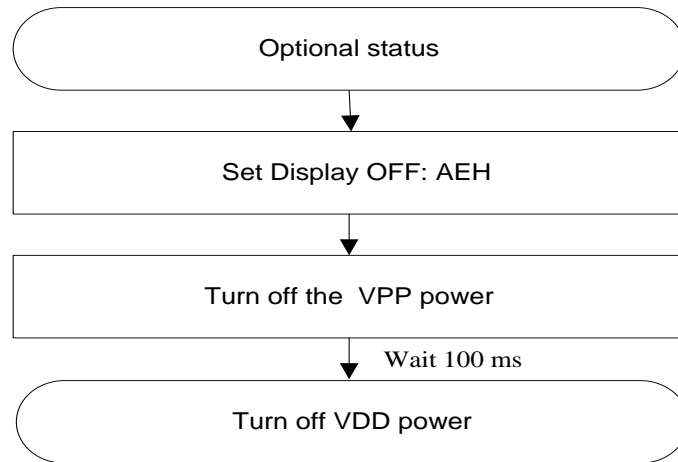

Note: There will be no damages to the display module if the power sequences are not met.

9.2. Application Circuit

9.2.1. Under external VPP Mode, the charge Pump Setting (ADh) must be set as follow:

ADh:DC-DC Control Mode Set DC-DC is disable(D="L", Refer to SH1108 IC Specification)

(1).The configuration for 8080-parallel interface mode, external VPP is shown in the following diagram:

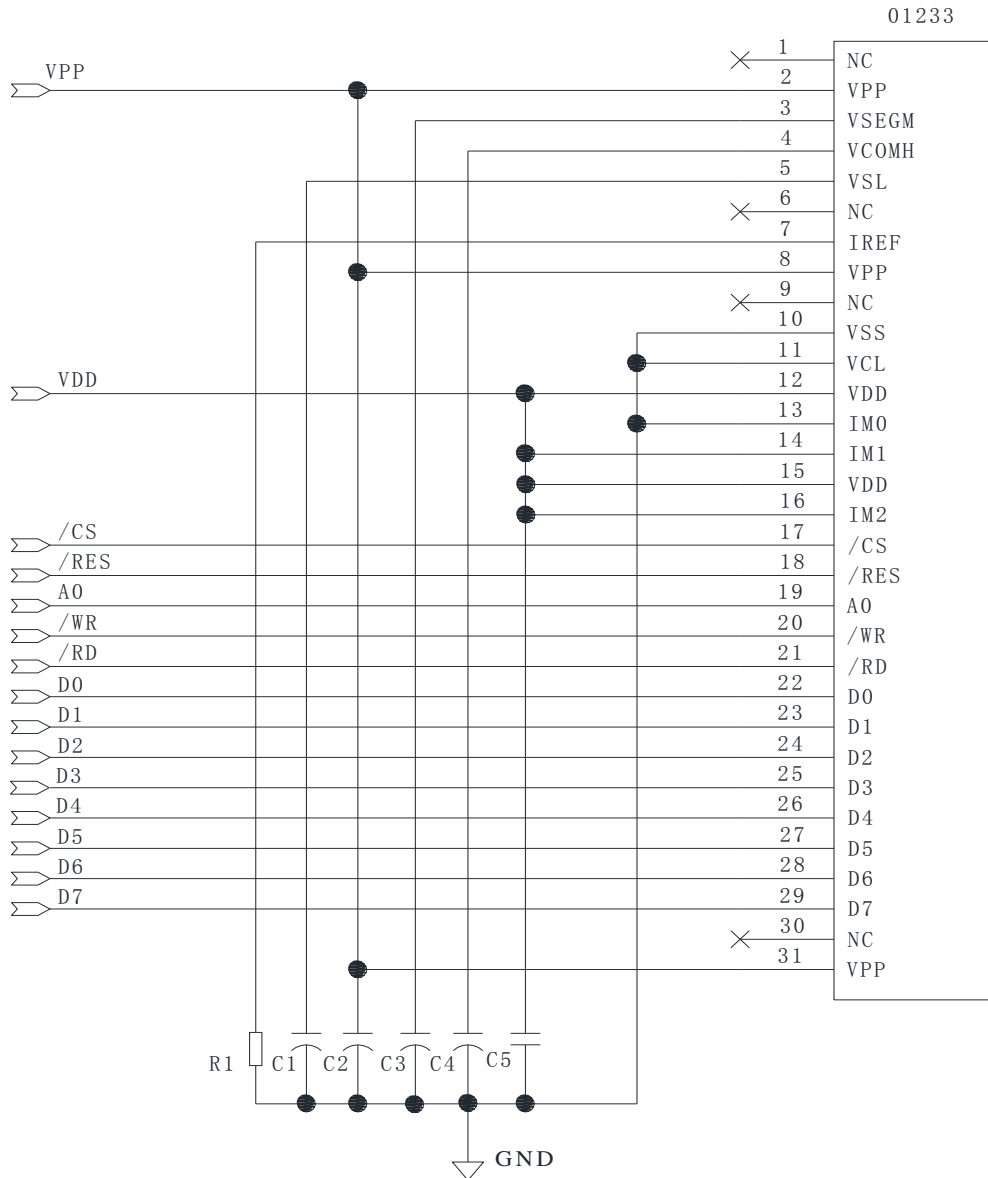

Pin connected to MCU interface: D[7:0],/RD,/WR,A0,/RES,/CS

Recommended components

C5: 0.1uF-0603-X7R±10%.RoHS

C1,C2,C3,C4: 4.7μF/25V.RoHS (Tantalum Capacitors)

R1: 0603 1/10W +/-5% 750Kohm.RoHS

(2).The configuration for 8-bit 6800-parallel interface mode, external VPP is shown in the following diagram:

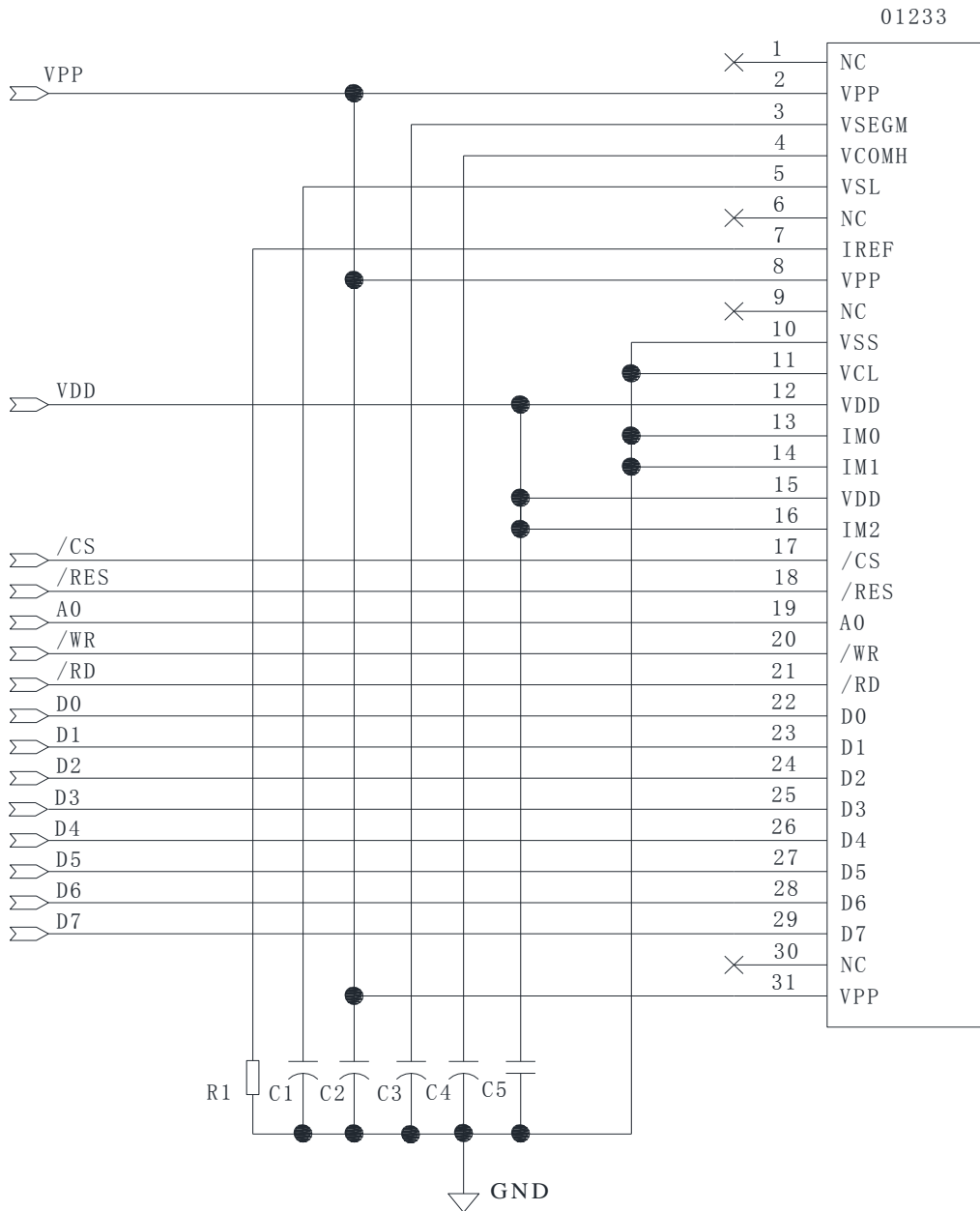

Pin connected to MCU interface: D[7:0],/RD, /WR ,A0,/RES,/CS

Recommended components

C5: 0.1uF-0603-X7R±10%.RoHS

C1,C2,C3,C4: 4.7μF/25V.RoHS (Tantalum Capacitors)

R1: 0603 1/10W +/-5% 750Kohm.RoHS

(3).The configuration for 4-wire SPI interface mode, external VPP is shown in the following diagram:

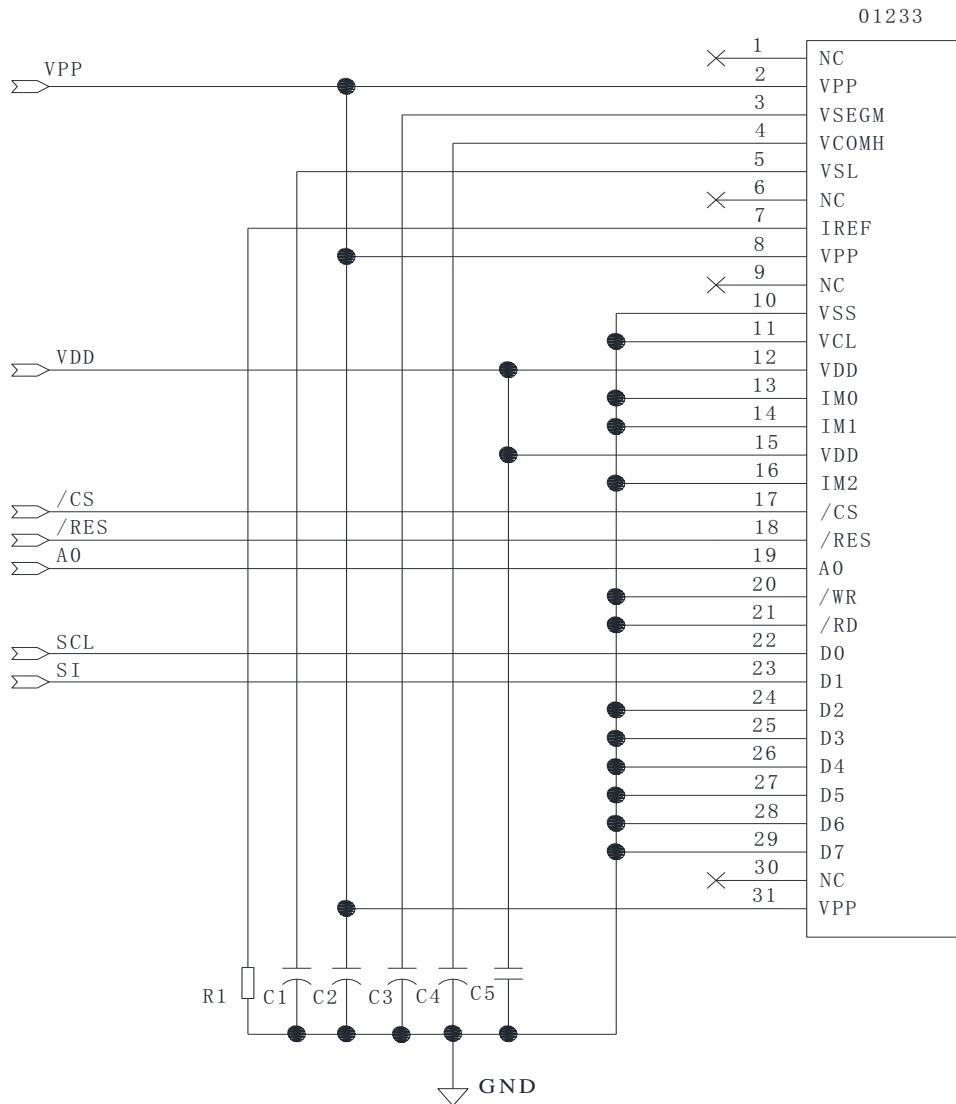

Pin connected to MCU interface: SI,SCL,/CS,A0,/RES.

Recommended components

C5: 0.1uF-0603-X7R±10%.RoHS

C1,C2,C3,C4: 4.7μF/25V.RoHS (Tantalum Capacitors)

R1: 0603 1/10W +/-5% 750Kohm.RoHS

(4).The configuration for 3-wire SPI interface mode, external VPP is shown in the following diagram:

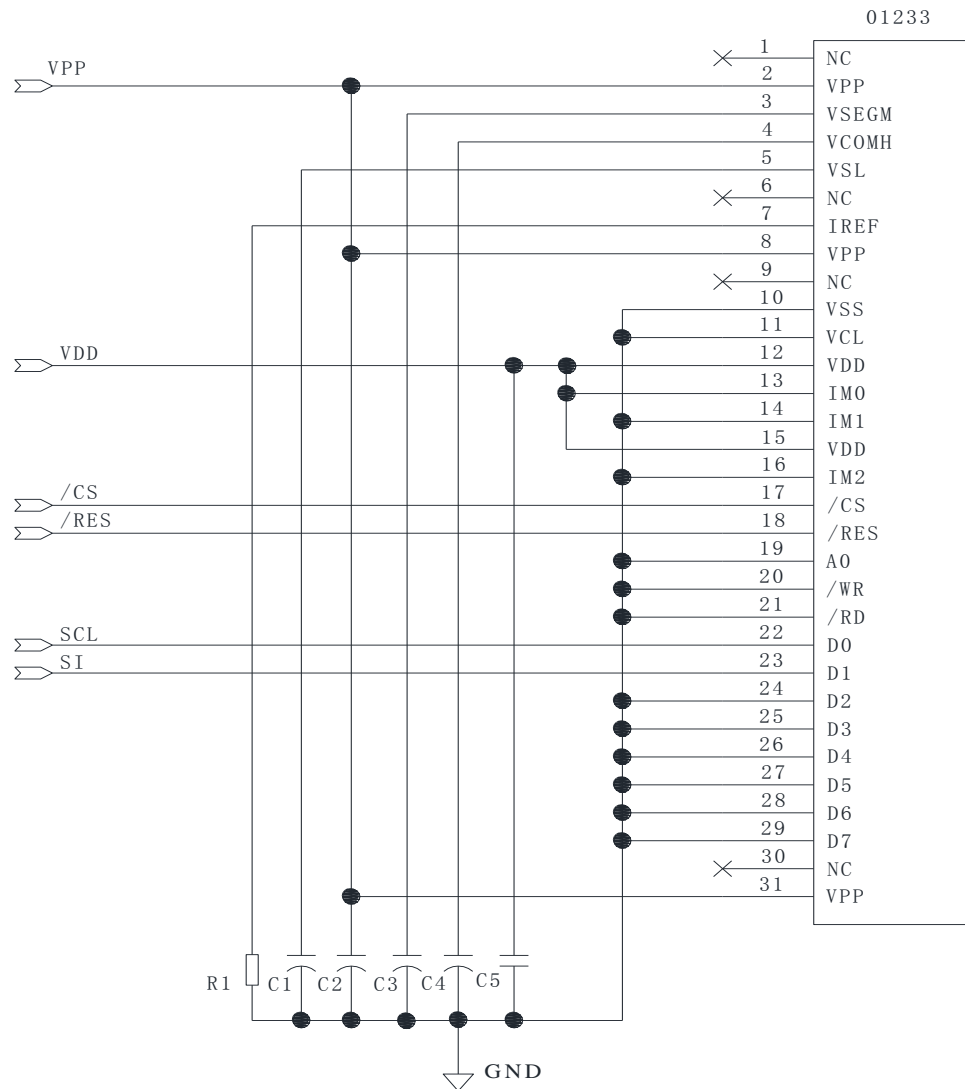

Pin connected to MCU interface: SI,SCL,/CS, /RES.

Recommended components

C5: 0.1uF-0603-X7R±10%.RoHS

C1,C2,C3,C4: 4.7μF/25V.RoHS (Tantalum Capacitors)

R1: 0603 1/10W +/-5% 750Kohm.RoHS

(5).The configuration for I²C interface mode, external VPP is shown in the following diagram:

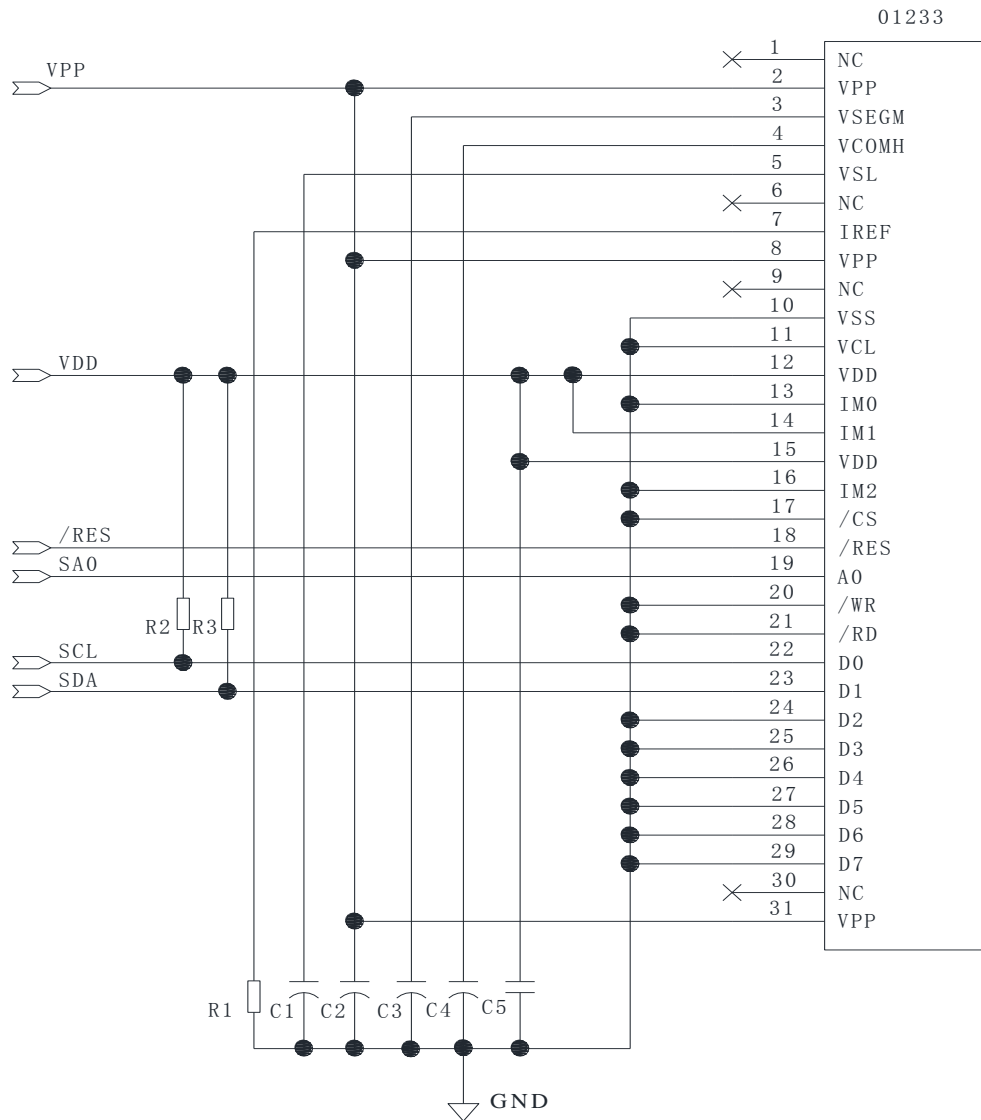

Pin connected to MCU interface:SDA,SCL,SA0,/RES.

SA0	I ² C Address
0	0x78
1	0x7A

Recommended components

C5: 0.1uF-0603-X7R±10%.RoHS

C1,C2,C3,C4: 4.7μF/25V.RoHS (Tantalum Capacitors)

R1: 0603 1/10W +/-5% 750Kohm.RoHS

R2,R3: 0603 1/10W +/-5% 10Kohm.RoHS

9.3. External DC-DC application circuit

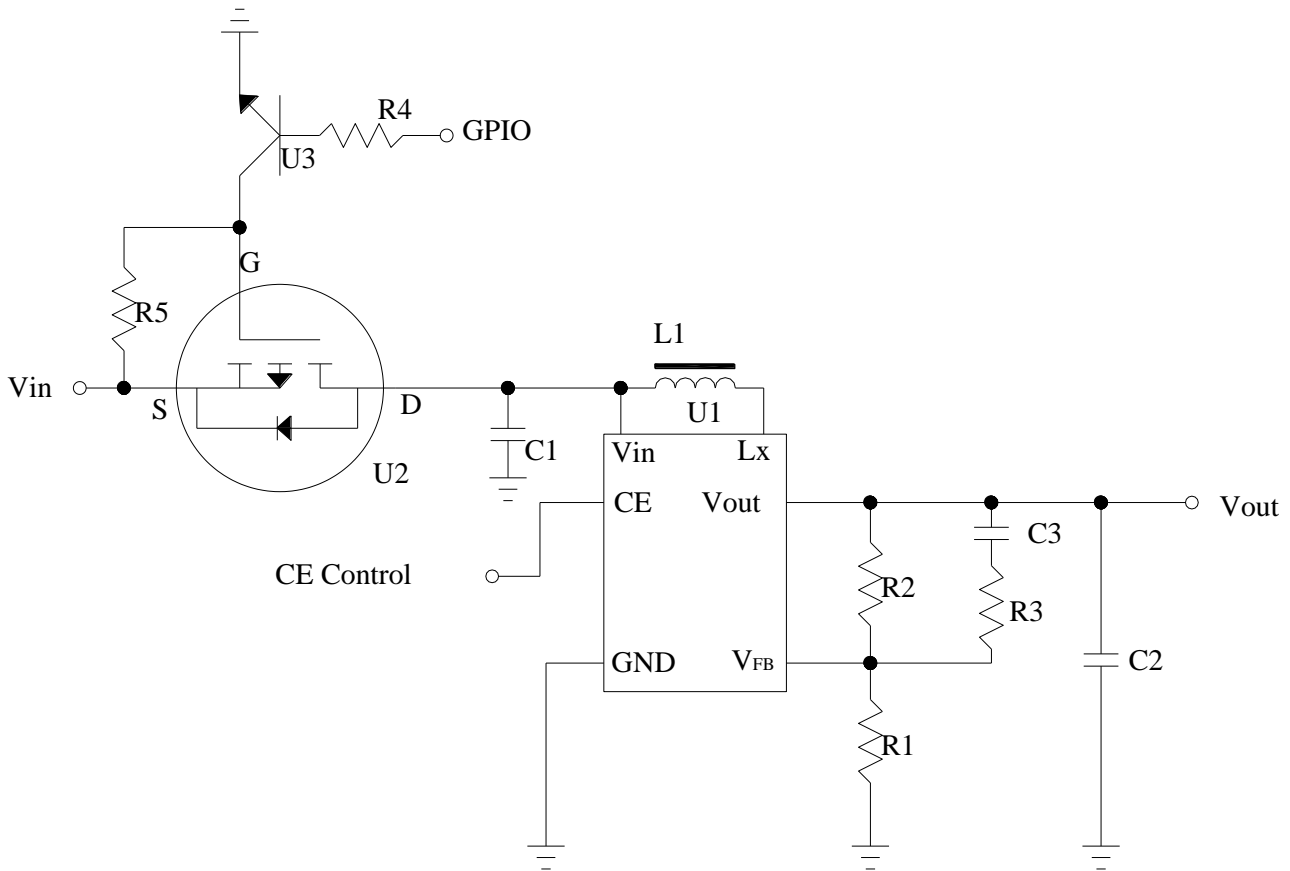

Recommend component

The C1	: 1 uF-0603-X7R±10%.RoHS
The C2	: 1 uF-0603-X7R±10%.RoHS
The C3	: 220pF-0603-X7R±10%.RoHS
The R1	: 0603 1/10W +/-5% 10Kohm.RoHS
The R2	: 0603 1/10W +/-5% 1.25Mohm.RoHS
The R3	: 0603 1/10W +/-5% 2Kohm.RoHS
The R4	: 0603 1/10W +/-5% 1Kohm.RoHS
The R5	: 0603 1/10W +/-5% 10Kohm.RoHS
The L1	: 22uH
The U1	: R1200
The U2	: FDN338P
The U3	: 8050

9.4. Display Control Instruction

Refer to SH1108 IC Specification.

9.5. Recommended Software Initialization





In order to ensure the reliability and stability of the module, the module must initialize use the following code, Malfunctioning of the module may occur and the reliability of the module may deteriorate if the module is used beyond the initialize code.

```
void init_program()
{
    write_c(0xae);           //Display OFF
    write_c(0x20);          // Set Memory addressing mode
    write_c(0x81);          // Set contrast control
    write_c(0xD0);
    write_c(0xa0);          // Segment remap
    write_c(0xa6);          // Normal display
    write_c(0xa9);          //Set Display Resolution
    write_c(0x02);          //160*128
    write_c(0xad);          // Set external VPP
    write_c(0x80);
    write_c(0xc0);          // Set Common scan direction
    write_c(0xd5);          // Divide Ratio/Oscillator Frequency Mode Set
    write_c(0xf1);          //100Hz
    write_c(0xd9);          // Set Dis-charge/Pre-charge Period
    write_c(0x13);
    write_c(0xdb);          // Set Vcomh voltage
    write_c(0x2b);          // 0.687*VPP
    write_c(0xdc);          //Set VSEGM Deselect Level
    write_c(0x35);
    write_c(0x30);          //Set Discharge VSL Level,0V
    Clear_screen();
    write_c(0xaf);          //Display ON
}
```

10. Package Specification

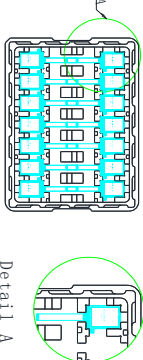
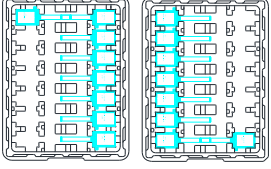
Controlled Seal

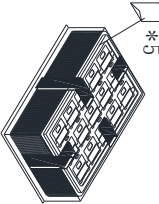
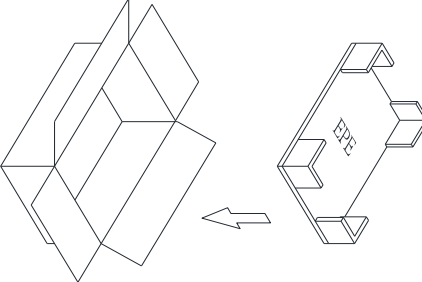
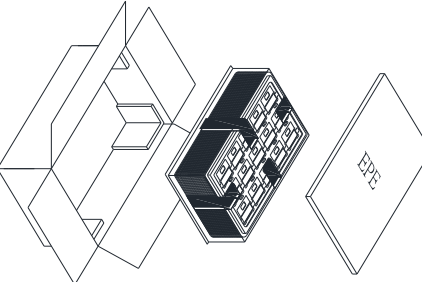
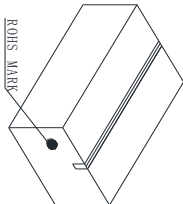
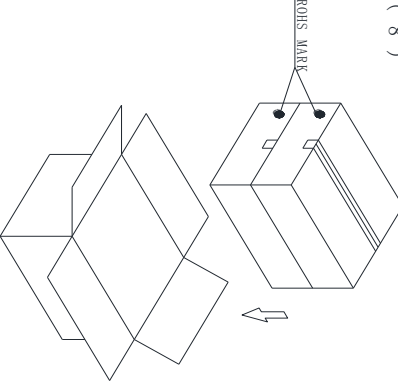
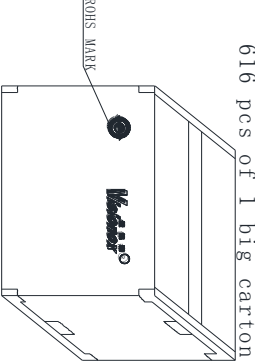
Packing Process (1) ~ (9)

<p>(1) TRAY Type:01233-MT1-A</p> 	<p>(2)</p>  <p>TRAY</p> <p>normal ①</p> <p>stavear .081 ②</p>	<p>(3) order ① ② ① ②</p> <p>fix trays with tape</p> <p>308 pcs of 1 small carton</p> <p>1 tray contain 14 pcs</p> <p>22 contained trays, 1 empty tray</p> 	<p>(4) package with plastic bags</p> <p>add five desiccants</p> <p>create a power vacuum</p>  <p>*5</p>
<p>(5)</p> 	<p>(6)</p> 	<p>(7)</p>  <p>small carton package</p>	<p>(8)</p>  <p>2 small cartons in 1 big carton</p>
<p>(9) 44 contained trays, 2 empty trays, Package quantity products: 616 pcs of 1 big carton</p>  <p>Package finished</p> <p>NOTE:1、The inner carton and master carton must be sealed with adhesive tape.</p> <p>2、Fill up the gap with EPE.</p> <p>3、If the customer has special needs with the RoHS making, the inner carton and master carton need adhesive new RoHS marking at  .</p>			

11. Reliability

11.1 Reliability Test

NO.	ITEM	CONDITION	QUANTITY
1	High Temperature (Non-operation)	85°C,240hrs	4
2	Low Temperature (Non-operation)	-40°C,240hrs	4
3	High Temperature (Operation)	70°C,240hrs	4
4	Low Temperature (Operation)	-40°C,240hrs	4
5	High Temperature / High Humidity (Operation)	60°C,90%RH,240hrs	4
6	Thermal shock (Non-operation)	-40°C~85°C(-40°C/30min;transit/3min;85°C/30min;transit/3min) 1cycle: 66min,30cycles	4
7	ESD Air discharge	+/-8kV,Test 9 points;Each point discharge 10 times.Time interval is less than 1 second	4
8	Vibration	Frequency: 5~50Hz,0.5G Scan rate: 1 oct/min Time: 2 hrs/axis Test axis: X,Y, Z	1 Carton
9	Drop	Height: 100 cm Sequence: 1 angle, 3 edges and 6 faces	1 Carton

Test and measurement conditions

- All measurements shall not be started until the specimens attain to temperature stability, the stable time is at least 15 minutes.
- The degradation of polarizer is ignored for item 5.
- The tolerance of temperature is $\pm 3^{\circ}\text{C}$, and the tolerance of relative humidity is $\pm 5\%$.

Evaluation criteria

- The function test is OK.
- No observable defects.
- Luminance: $\geq 50\%$ of initial value.
- Current consumption: within $\pm 50\%$ of initial value.

11.2 Lifetime

End of lifetime is specified as 50% of initial brightness and the test pattern at operating condition is 50% alternating checkerboard.

ITEM	MIN	MAX	UNIT	CONDITION
Operation Life Time	10,000	-	hrs	280 cd/m ² , 50% alternating checkerboard, 22 \pm 3°C, 55 \pm 15% RH

11.3 Failure Check Standard

After the completion of the described reliability test, the samples were left at room temperature for 2 hrs prior to conducting the failure test at 22 \pm 3°C; 55 \pm 15% RH.

12 Illustration of OLED Product Name

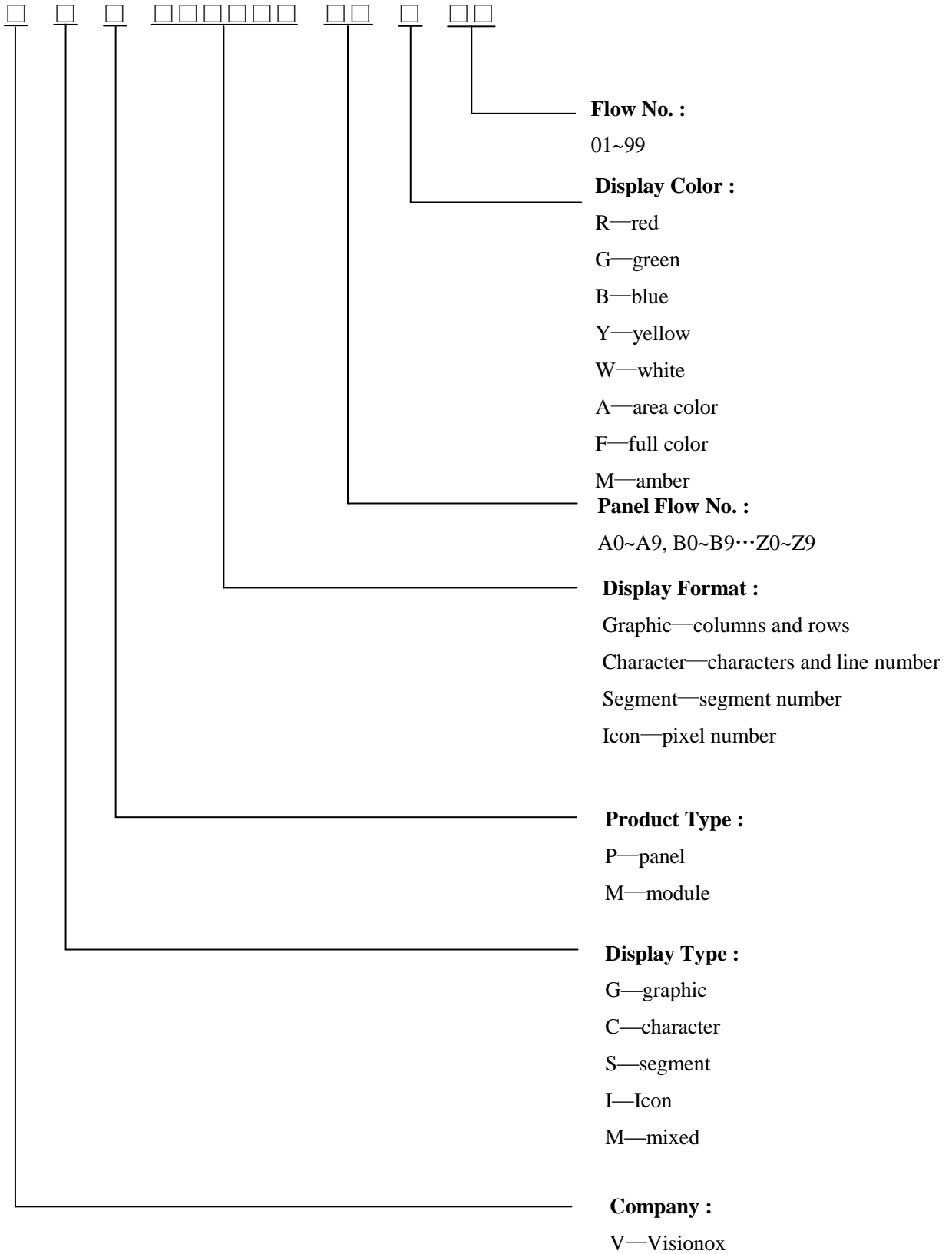

13 Outgoing Quality Control Specifications

13.1 Sampling Method

- (1) GB/T 2828.1,ISO2859-1: inspection level II , normal inspection, single sample inspection
- (2) AQL: Major 0.65; Minor 1.0

13.2 Inspection Conditions

The environmental conditions for test and measurement are performed as follows.

Temperature: $22\pm 3^{\circ}\text{C}$

Humidity: $55\pm 15\%\text{R.H}$

Fluorescent Lamp: 30W

Distance between the Panel & Lamp: $\geq 50\text{cm}$

Distance between the Panel & Eyes: $\geq 30\text{cm}$

Viewing angle from the vertical in each direction: $\leq 45^{\circ}$

(See the sketch below)

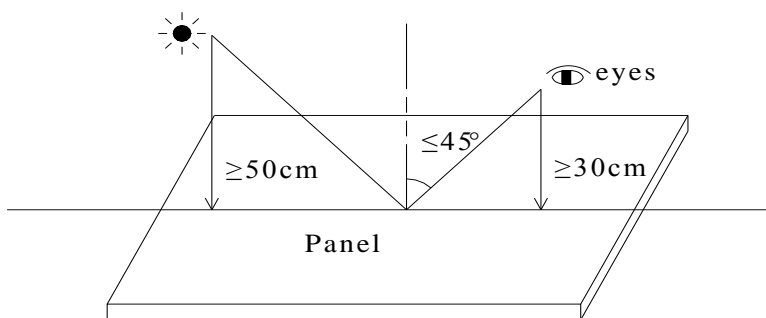

13.3 Quality Assurance Zones

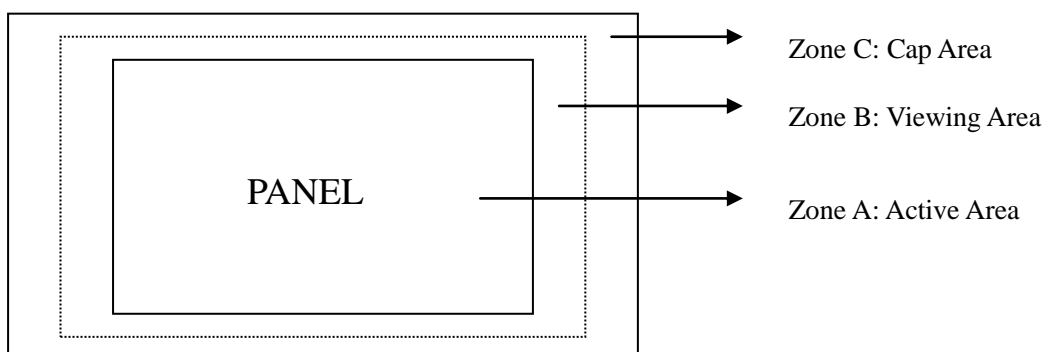

13.4 Inspection Standard

Definition of Φ &L&W (Unit: mm)

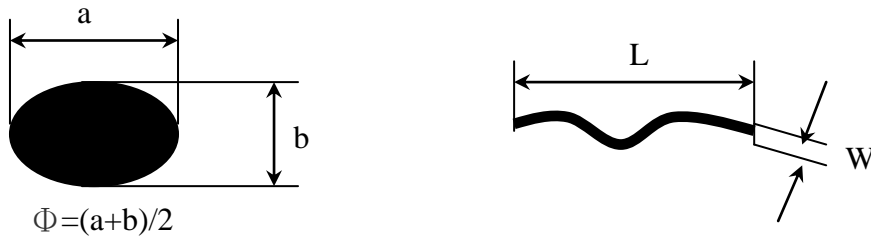

I . Appearance Defects

NO.	ITEM	CRITERIA	CLASSIFICATION																	
1	Polarizer Black or White spot, Dirty spot, Foreign matter, Dent on the polarizer	<table border="1"> <thead> <tr> <th rowspan="2">Average Diameter (mm)</th> <th colspan="2">Acceptable Number</th> </tr> <tr> <th>Zone A,B</th> <th>Zone C</th> </tr> </thead> <tbody> <tr> <td>$\Phi \leq 0.15$</td> <td colspan="2">Ignore</td> </tr> <tr> <td>$0.15 < \Phi \leq 0.30$</td> <td>3</td> <td rowspan="2">Ignore</td> </tr> <tr> <td>$\Phi > 0.30$</td> <td>0</td> </tr> </tbody> </table>	Average Diameter (mm)	Acceptable Number		Zone A,B	Zone C	$\Phi \leq 0.15$	Ignore		$0.15 < \Phi \leq 0.30$	3	Ignore	$\Phi > 0.30$	0	Minor				
Average Diameter (mm)	Acceptable Number																			
	Zone A,B	Zone C																		
$\Phi \leq 0.15$	Ignore																			
$0.15 < \Phi \leq 0.30$	3	Ignore																		
$\Phi > 0.30$	0																			
2	Scratch/line on the glass/Polarizer	<table border="1"> <thead> <tr> <th rowspan="2">Width (mm)</th> <th rowspan="2">Length (mm)</th> <th colspan="2">Acceptable Number</th> </tr> <tr> <th>Zone A,B</th> <th>Zone C</th> </tr> </thead> <tbody> <tr> <td>$W \leq 0.03$</td> <td>---</td> <td colspan="2">Ignore</td> </tr> <tr> <td>$0.03 < W \leq 0.08$</td> <td>$L \leq 5.0$</td> <td>3</td> <td rowspan="2">Ignore</td> </tr> <tr> <td>$W > 0.08$</td> <td>---</td> <td>0</td> </tr> </tbody> </table>	Width (mm)	Length (mm)	Acceptable Number		Zone A,B	Zone C	$W \leq 0.03$	---	Ignore		$0.03 < W \leq 0.08$	$L \leq 5.0$	3	Ignore	$W > 0.08$	---	0	Minor
Width (mm)	Length (mm)	Acceptable Number																		
		Zone A,B	Zone C																	
$W \leq 0.03$	---	Ignore																		
$0.03 < W \leq 0.08$	$L \leq 5.0$	3	Ignore																	
$W > 0.08$	---	0																		
3	Polarizer Bubble	<table border="1"> <thead> <tr> <th rowspan="2">Average Diameter (mm)</th> <th colspan="2">Acceptable Number</th> </tr> <tr> <th>Zone A,B</th> <th>Zone C</th> </tr> </thead> <tbody> <tr> <td>$\Phi > 0.5$</td> <td>0</td> <td rowspan="3">Ignore</td> </tr> <tr> <td>$0.2 < \Phi \leq 0.5$</td> <td>3</td> </tr> <tr> <td>$\Phi \leq 0.2$</td> <td>Ignore</td> </tr> </tbody> </table>	Average Diameter (mm)	Acceptable Number		Zone A,B	Zone C	$\Phi > 0.5$	0	Ignore	$0.2 < \Phi \leq 0.5$	3	$\Phi \leq 0.2$	Ignore	Minor					
Average Diameter (mm)	Acceptable Number																			
	Zone A,B	Zone C																		
$\Phi > 0.5$	0	Ignore																		
$0.2 < \Phi \leq 0.5$	3																			
$\Phi \leq 0.2$	Ignore																			
4	Any Dirt & Scratch on Polarizer's Protective Film	Ignore for not affect the polarizer.	Minor																	
5	Any Dirt on Cap Glass	<table border="1"> <thead> <tr> <th>Average Diameter (mm)</th> <th>Acceptable Number</th> </tr> </thead> <tbody> <tr> <td>$\Phi \leq 0.5$</td> <td>Ignore</td> </tr> <tr> <td>$0.5 < \Phi \leq 1.0$</td> <td>3</td> </tr> <tr> <td>$\Phi > 1.0$</td> <td>0</td> </tr> </tbody> </table>	Average Diameter (mm)	Acceptable Number	$\Phi \leq 0.5$	Ignore	$0.5 < \Phi \leq 1.0$	3	$\Phi > 1.0$	0	Minor									
Average Diameter (mm)	Acceptable Number																			
$\Phi \leq 0.5$	Ignore																			
$0.5 < \Phi \leq 1.0$	3																			
$\Phi > 1.0$	0																			

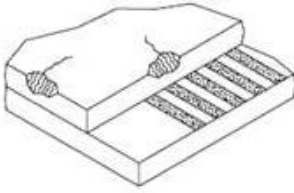
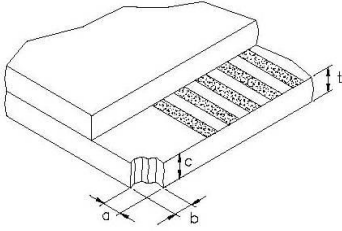
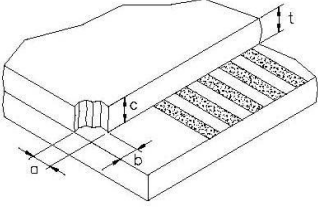
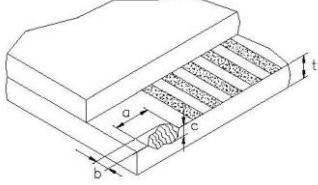
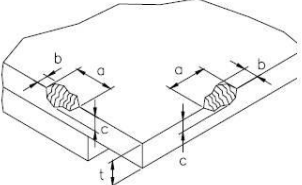
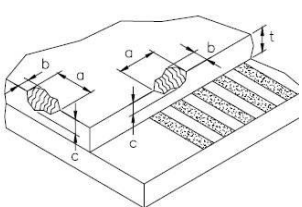
6	Glass Crack	 <p>Propagation crack is not acceptable.</p>	Major
7	Corner Chip	 <p>t= Glass thickness Accept $a \leq 2.0\text{mm}$ or $b \leq 2.0\text{mm}$, $c \leq t$</p>	Minor
8	Corner Chip on Cap Glass	 <p>t= Glass thickness Accept $a \leq 1.5\text{mm}$ or $b \leq 1.5\text{mm}$, $c \leq t$</p>	Minor
9	Chip on Contact Pad	 <p>t= Glass thickness Accept $a \leq 3.0\text{mm}$ or $b \leq 0.8\text{mm}$, $c \leq t$ (on the contact pin) $a \leq 3.0\text{mm}$ or $b \leq 1.5\text{mm}$, $c \leq t$ (outside of the contact pin)</p>	Minor
10	Chip on Face of Display	 <p>t= Glass thickness Accept $a \leq 1.5\text{mm}$ or $b \leq 1.5\text{mm}$, $c \leq t$</p>	Minor
11	Chip on Cap Glass	 <p>t= Glass thickness Accept $a \leq 3.0\text{mm}$ or $b \leq 3.0\text{mm}$, $c \leq t/2$ $a \leq 1.5\text{mm}$ or $b \leq 1.5\text{mm}$, $t/2 \leq c \leq t$</p>	Minor
12	Stain on Surface	Stain removable by soft cloth or air blow is acceptable.	Minor
13	TCP/FPC Damage	<p>(1) Crack, deep scratch, deep hole and deep pressure mark on the TCP/FPC are not acceptable. (2) Terminal lead twisted or broken is not allowable. (3) Copper exposed is not allowed by naked eye inspection.</p>	Minor
14	Dimension Unconformity	Checking by mechanical drawing.	Major

II. Displaying Defects

NO.	ITEM	CRITERIA	CLASSIFICATION															
1	Black/White spot Dirty spot Foreign matter	<table border="1"> <thead> <tr> <th data-bbox="517 367 794 434">Average Diameter (mm)</th> <th colspan="2" data-bbox="794 367 1155 405">Pieces Permitted</th> </tr> <tr> <td data-bbox="517 434 794 472">$\Phi \leq 0.10$</td> <td data-bbox="794 405 979 434">Zone A,B</td> <td data-bbox="979 405 1155 434">Zone C</td> </tr> </thead> <tbody> <tr> <td data-bbox="517 472 794 510">$0.10 < \Phi \leq 0.20$</td> <td colspan="2" data-bbox="794 434 1155 472">Ignore</td> </tr> <tr> <td data-bbox="517 510 794 539">$\Phi > 0.20$</td> <td data-bbox="794 472 979 510">3</td> <td data-bbox="979 472 1155 510">Ignore</td> </tr> <tr> <td data-bbox="517 539 794 568">$\Phi > 0.20$</td> <td data-bbox="794 510 979 539">0</td> <td data-bbox="979 510 1155 539">Ignore</td> </tr> </tbody> </table>	Average Diameter (mm)	Pieces Permitted		$\Phi \leq 0.10$	Zone A,B	Zone C	$0.10 < \Phi \leq 0.20$	Ignore		$\Phi > 0.20$	3	Ignore	$\Phi > 0.20$	0	Ignore	Minor
Average Diameter (mm)	Pieces Permitted																	
$\Phi \leq 0.10$	Zone A,B	Zone C																
$0.10 < \Phi \leq 0.20$	Ignore																	
$\Phi > 0.20$	3	Ignore																
$\Phi > 0.20$	0	Ignore																
2	No Display	Not allowable.	Major															
3	Irregular Display	Not allowable.	Major															
4	Missing Line (row or column)	Not allowable.	Major															
5	Short	Not allowable.	Major															
6	Flicker	Not allowable.	Major															
7	Abnormal Color	Refer to the SPEC.	Major															
8	Luminance NG	Refer to the SPEC.	Major															
9	Over Current	Refer to the SPEC.	Major															

14 Precautions for operation and Storage

14.1 Precautions for Operation

- (1) Since OLED panel is made of glass, do not apply any mechanical shock or impact or excessive force to it when installing the OLED module. Any strong mechanical impact due to falling dropping etc. may cause damage (breakage or cracking).
- (2) The polarizer on the OLED surface is made of soft material and is easily scratched. Please take most care when handing. When the surface of the polarizer of OLED Module is contaminated, please wipe it off gently by using moisten soft cloth with isopropyl alcohol, do not use water, ketone or aromatics. If there is saliva or water on the OLED surface, please wipe it off immediately.
- (3) When handling OLED module, please be sure that the body and the tools are properly grounded. And do not touch I/O pins with bare hands or contaminate I/O pins, it will cause disconnection or defective insulation of terminals.
- (4) Do not attempt to disassemble or process the OLED module.
- (5) OLED module should be used under recommended operating conditions shown in the specification. Since the higher voltage leads to the shorter lifetime, be sure to use the specified operating voltage.
- (6) Foggy dew, moisture condensation or water droplets deposited on surface and contact terminals will cause polarizer stain or damage, the deteriorated display quality and electrochemical reaction then leads to shorter life time and permanent damage to the module probably. Please pay attention to the environmental temperature and humidity.
- (7) An afterimage is created by the difference in brightness between unused dot and the fixed dot, according to the decrease of brightness of the emitting time. Therefore, to avoid having an afterimage, the full set should be thoroughly used instead of using a fixed dot. When the fixed dot emits, an afterimage can be created.
- (8) Flicker could be come out at full on display. And it disappears when frame frequency increase, but brightness decreases too.

14.2 Soldering

- (1) Soldering should be performed only on the I/O terminals.
- (2) Use soldering irons with proper grounding and no leakage.
- (3) Iron: The temperature setting of electric iron is 350°C, but we suggest that during soldering, the temperature of iron tip should be no higher than 330°C and soldering be finished within 3~4 seconds

14.3 Precautions for Storage

- (1) Please store OLED module in a dark place. Avoid exposure to sunlight, the light of fluorescent lamp or any ultraviolet ray.
- (2) Keep the environment temperature between 10°C and 35°C and the relative humidity less than 60%. Avoid high temperature and high humidity.
- (3) Keep the OLED modules stored in the container when shipped from supplier before using them is recommended.
- (4) Do not leave any article on the OLED module surface for an extended period of time.

14.4 Warranty period

Visionox warrants for a period of 12 months from the shipping date when stored or used under normal condition.



Компания «ЭлектроПласт» предлагает заключение долгосрочных отношений при поставках импортных электронных компонентов на взаимовыгодных условиях!

Наши преимущества:

- Оперативные поставки широкого спектра электронных компонентов отечественного и импортного производства напрямую от производителей и с крупнейших мировых складов;
- Поставка более 17-ти миллионов наименований электронных компонентов;
- Поставка сложных, дефицитных, либо снятых с производства позиций;
- Оперативные сроки поставки под заказ (от 5 рабочих дней);
- Экспресс доставка в любую точку России;
- Техническая поддержка проекта, помощь в подборе аналогов, поставка прототипов;
- Система менеджмента качества сертифицирована по Международному стандарту ISO 9001;
- Лицензия ФСБ на осуществление работ с использованием сведений, составляющих государственную тайну;
- Поставка специализированных компонентов (Xilinx, Altera, Analog Devices, Intersil, Interpoint, Microsemi, Aeroflex, Peregrine, Syfer, Eurofarad, Texas Instrument, Miteq, Cobham, E2V, MA-COM, Hittite, Mini-Circuits, General Dynamics и др.);

Помимо этого, одним из направлений компании «ЭлектроПласт» является направление «Источники питания». Мы предлагаем Вам помощь Конструкторского отдела:

- Подбор оптимального решения, техническое обоснование при выборе компонента;
- Подбор аналогов;
- Консультации по применению компонента;
- Поставка образцов и прототипов;
- Техническая поддержка проекта;
- Защита от снятия компонента с производства.



Как с нами связаться

Телефон: 8 (812) 309 58 32 (многоканальный)

Факс: 8 (812) 320-02-42

Электронная почта: org@eplast1.ru

Адрес: 198099, г. Санкт-Петербург, ул. Калинина, дом 2, корпус 4, литера А.