

Quad DC/DC μ Module Regulator with Configurable 4A Output Array

FEATURES

- Quad Output Step-Down μ Module® Regulator with 4A per Output
- Wide Input Voltage Range: 4V to 14V
 - 2.375V to 14V with External Bias
- 0.6V to 5.5V Output Voltage
- 4A DC, 5A Peak Output Current Each Channel
- Up to 5.5W Power Dissipation ($T_A = 60^\circ\text{C}$, 200 LFM, No Heat Sink)
- $\pm 1.5\%$ Total Output Voltage Regulation
- Current Mode Control, Fast Transient Response
- Parallelable for Higher Output Current
- Output Voltage Tracking
- Internal Temperature Sensing Diode Output
- External Frequency Synchronization
- Overvoltage, Current and Temperature Protection
- 9mm \times 15mm \times 5.01mm BGA Package

APPLICATIONS

- Multirail Point of Load Regulation
- FPGAs, DSPs and ASICs Applications

All registered trademarks and trademarks are the property of their respective owners.

DESCRIPTION

The LTM4644/LTM4644-1 is a quad DC/DC step-down μ Module (micromodule) regulator with 4A per output. Outputs can be paralleled in an array for up to 16A capability. Included in the package are the switching controllers, power FETs, inductors and support components. Operating over an input voltage range of 4V to 14V or 2.375V to 14V with an external bias supply, the LTM4644/LTM4644-1 supports an output voltage range of 0.6V to 5.5V. Its high efficiency design delivers 4A continuous (5A peak) output current per channel. Only bulk input and output capacitors are needed.

	LTM4644	LTM4644-1
Top Feedback Resistor from V_{OUT}-to-V_{FB} (one resistor per channel)	Integrated 60.4k 0.5% Resistor	External (to be added on PCB)
Application	General Applications	To Interface with PMBus power system management supervisory ICs such as the LTC2975

Configurable Output Array*

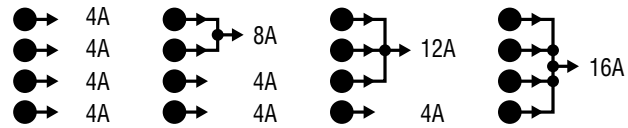

* Note 4

[Click to view associated TechClip Videos.](#)

TYPICAL APPLICATION

4V to 14V Input, Quad 0.9V, 1V, 1.2V and 1.5V Output DC/DC μ Module Regulator*

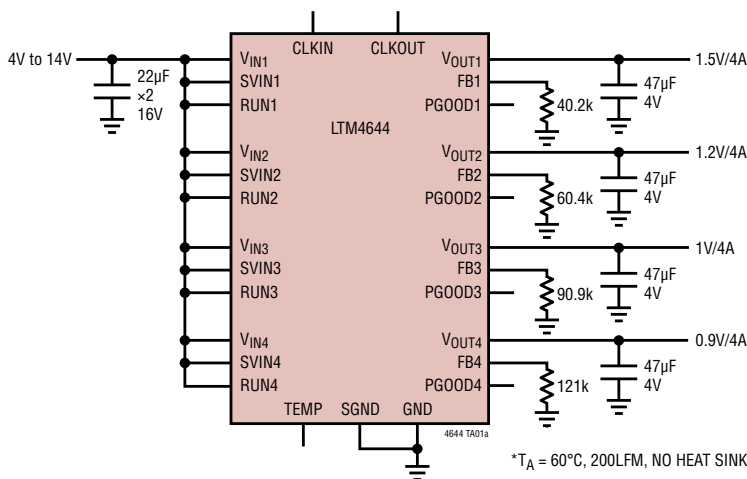

* $T_A = 60^\circ\text{C}$, 200LFM, NO HEAT SINK

1.5V Output Efficiency and Power Loss (Each Channel)

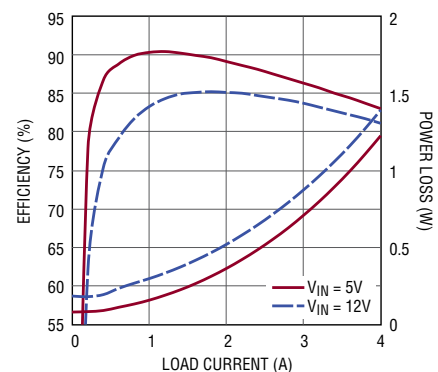

LTM4644/LTM4644-1

ABSOLUTE MAXIMUM RATINGS

(Note 1)

V_{IN} , SV_{IN} (Per Channel).....	-0.3V to 15V
V_{OUT} (Per Channel) (Note 3)	-0.3V to SV_{IN} or 6V
RUN (Per Channel).....	-0.3V to 15V
$INTV_{CC}$ (Per Channel)	-0.3V to 3.6V
$PGOOD$, $MODE$, $TRACK/SS$, FB (Per Channel)	-0.3V to $INTV_{CC}$
$CLKOUT$ (Note 3), $CLKIN$	-0.3V to $INTV_{CC}$
Internal Operating Temperature Range (Note 2, 5)	
E and I-Grade.....	-40°C to 125°C
MP-Grade	-55°C to 125°C
Storage Temperature Range	-65°C to 150°C
Peak Solder Reflow Body Temperature	245°C

PIN CONFIGURATION

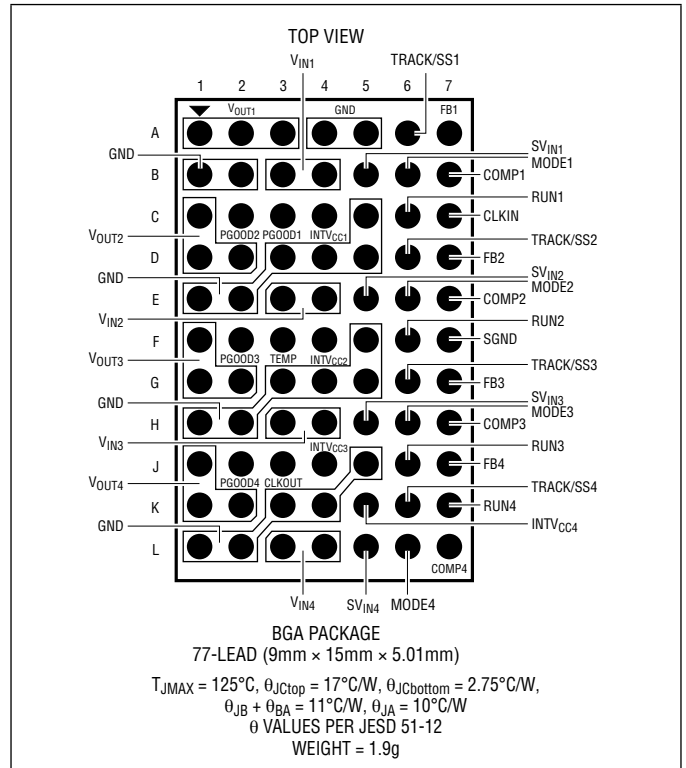

ORDER INFORMATION

PART NUMBER	PAD OR BALL FINISH	PART MARKING*		PACKAGE TYPE	MSL RATING	TEMPERATURE RANGE (SEE NOTE 2)
		DEVICE	FINISH CODE			
LTM4644EY#PBF	SAC305 (RoHS)	LTM4644Y	e1	BGA	3	-40°C to 125°C
LTM4644IY#PBF	SAC305 (RoHS)	LTM4644Y	e1	BGA	3	-40°C to 125°C
LTM4644MPY#PBF	SAC305 (RoHS)	LTM4644Y	e1	BGA	3	-55°C to 125°C
LTM4644IY	SnPb (63/37)	LTM4644Y	e0	BGA	3	-40°C to 125°C
LTM4644MPY	SnPb (63/37)	LTM4644Y	e0	BGA	3	-55°C to 125°C
LTM4644EY-1#PBF	SAC305 (RoHS)	LTM4644Y-1	e1	BGA	3	-40°C to 125°C
LTM4644IY-1#PBF	SAC305 (RoHS)	LTM4644Y-1	e1	BGA	3	-40°C to 125°C
LTM4644IY-1	SnPb (63/37)	LTM4644Y-1	e0	BGA	3	-40°C to 125°C

Note: The LTM4644-1 does not include the internal top feedback resistor.

- Contact the factory for parts specified with wider operating temperature ranges. *Pad or ball finish code is per IPC/JEDEC J-STD-609.
- [Recommended LGA and BGA PCB Assembly and Manufacturing Procedures](#)
- [LGA and BGA Package and Tray Drawings](#)

ELECTRICAL CHARACTERISTICS

The ● denotes the specifications which apply over the full operating temperature range, otherwise specifications are at $T_A = 25^\circ\text{C}$ (Note 2). $V_{IN} = 12\text{V}$, per the typical application.

SYMBOL	PARAMETER	CONDITIONS	MIN	TYP	MAX	UNITS	
Switching Regulator Section: per Channel							
V_{IN}, SV_{IN}	Input DC Voltage	$SV_{IN} = V_{IN}$	● 4		14	V	
$V_{OUT(RANGE)}$	Output Voltage Range		● 0.6		5.5	V	
$V_{OUT(DC)}$	Output Voltage, Total Variation with Line and Load	$C_{IN} = 22\mu\text{F}$, $C_{OUT} = 100\mu\text{F}$ Ceramic, MODE = INTV _{CC} , $V_{IN} = 4\text{V}$ to 14V , $I_{OUT} = 0\text{A}$ to 4A (Note 4) LTM4644: $R_{FB(BOT)} = 40.2\text{k}$ LTM4644-1: $R_{FB(TOP)} = 60.4\text{k}$, $R_{FB(BOT)} = 40.2\text{k}$	● 1.477	1.50	1.523	V	
V_{RUN}	RUN Pin On Threshold	V_{RUN} Rising		1.1	1.2	1.3	V
$I_Q(SVIN)$	Input Supply Bias Current	$V_{IN} = 12\text{V}$, $V_{OUT} = 1.5\text{V}$, MODE = INTV _{CC} $V_{IN} = 12\text{V}$, $V_{OUT} = 1.5\text{V}$, MODE = GND Shutdown, RUN = 0, $V_{IN} = 12\text{V}$		6 2 11		mA mA μA	
$I_S(VIN)$	Input Supply Current	$V_{IN} = 12\text{V}$, $V_{OUT} = 1.5\text{V}$, $I_{OUT} = 4\text{A}$		0.62		A	
$I_{OUT(DC)}$	Output Continuous Current Range	$V_{IN} = 12\text{V}$, $V_{OUT} = 1.5\text{V}$ (Note 4)		0	4	A	
$\Delta V_{OUT}(\text{Line})/V_{OUT}$	Line Regulation Accuracy	$V_{OUT} = 1.5\text{V}$, $V_{IN} = 4\text{V}$ to 14V , $I_{OUT} = 0\text{A}$	●	0.04	0.15	%/V	
$\Delta V_{OUT}(\text{Load})/V_{OUT}$	Load Regulation Accuracy	$V_{OUT} = 1.5\text{V}$, $I_{OUT} = 0\text{A}$ to 4A	●	0.5	1	%	
$V_{OUT(AC)}$	Output Ripple Voltage	$I_{OUT} = 0\text{A}$, $C_{OUT} = 100\mu\text{F}$ Ceramic, $V_{IN} = 12\text{V}$, $V_{OUT} = 1.5\text{V}$		5		mV	
$\Delta V_{OUT(START)}$	Turn-On Overshoot	$I_{OUT} = 0\text{A}$, $C_{OUT} = 100\mu\text{F}$ Ceramic, $V_{IN} = 12\text{V}$, $V_{OUT} = 1.5\text{V}$		30		mV	
t_{START}	Turn-On Time	$C_{OUT} = 100\mu\text{F}$ Ceramic, No Load, TRACK/SS = $0.01\mu\text{F}$, $V_{IN} = 12\text{V}$, $V_{OUT} = 1.5\text{V}$		2.5		ms	
ΔV_{OUTLS}	Peak Deviation for Dynamic Load	Load: 0% to 50% to 0% of Full Load, $C_{OUT} = 47\mu\text{F}$ Ceramic, $V_{IN} = 12\text{V}$, $V_{OUT} = 1.5\text{V}$		160		mV	
t_{SETTLE}	Settling Time for Dynamic Load Step	Load: 0% to 50% to 0% of Full Load, $C_{OUT} = 47\mu\text{F}$ Ceramic, $V_{IN} = 12\text{V}$, $V_{OUT} = 1.5\text{V}$		40		μs	
I_{OUTPK}	Output Current Limit	$V_{IN} = 12\text{V}$, $V_{OUT} = 1.5\text{V}$		6	7	A	
V_{FB}	Voltage at FB Pin	$I_{OUT} = 0\text{A}$, $V_{OUT} = 1.5\text{V}$, 0°C to 125°C $I_{OUT} = 0\text{A}$, $V_{OUT} = 1.5\text{V}$, -40°C to 125°C	● 0.594 0.592	0.60 0.60	0.606 0.608	V V	
I_{FB}	Current at FB Pin	(Note 3)			±30	nA	
R_{FBHI}	Resistor Between V_{OUT} and FB Pins	LTM4644 Only		60.05	60.40	60.75	kΩ
$I_{TRACK/SS}$	Track Pin Soft-Start Pull-Up Current	TRACK/SS = 0V		2.5	4	μA	
$V_{IN(UVLO)}$	V_{IN} Undervoltage Lockout	V_{IN} Falling V_{IN} Hysteresis		2.4	2.6 350	2.8 mV	V mV
$t_{ON(MIN)}$	Minimum On-Time	(Note 3)		40		ns	
$t_{OFF(MIN)}$	Minimum Off-Time	(Note 3)		70		ns	
V_{PGOOD}	PGOOD Trip Level	V_{FB} With Respect to Set Output V_{FB} Ramping Negative V_{FB} Ramping Positive		-13 7	-10 10	-7 13	% %
I_{PGOOD}	PGOOD Leakage				2	μA	
V_{PGL}	PGOOD Voltage Low	$I_{PGOOD} = 1\text{mA}$		0.02	0.1	V	
V_{INTVCC}	Internal V_{CC} Voltage	$SV_{IN} = 4\text{V}$ to 14V		3.2	3.3	3.4	V
V_{INTVCC} Load Reg	INTV _{CC} Load Regulation	$I_{CC} = 0\text{mA}$ to 20mA		0.5		%	
f_{OSC}	Oscillator Frequency			1		MHz	
CLKIN	CLKIN Threshold			0.7		V	

ELECTRICAL CHARACTERISTICS

Note 1: Stresses beyond those listed under Absolute Maximum Ratings may cause permanent damage to the device. Exposure to any Absolute Maximum Rating condition for extended periods may affect device reliability and lifetime.

Note 2: The LTM4644E/LTM4644E-1 is tested under pulsed load conditions such that $T_J \approx T_A$. The LTM4644E/LTM4644-1 is guaranteed to meet performance specifications over the 0°C to 125°C internal operating temperature range. Specifications over the full -40°C to 125°C internal operating temperature range are assured by design, characterization and correlation with statistical process controls. The LTM4644/LTM4644-1 is guaranteed to meet specifications over the full -40°C to 125°C internal operating temperature range. The LTM4644MP/LTM4644MP-1 is tested

and guaranteed over full -55°C to 125°C internal operating temperature range. Note that the maximum ambient temperature consistent with these specifications is determined by specific operating conditions in conjunction with board layout, the rated package thermal resistance and other environmental factors.

Note 3: 100% tested at wafer level.

Note 4: See output current derating curves for different V_{IN} , V_{OUT} and T_A .

Note 5: This IC includes overtemperature protection that is intended to protect the device during momentary overload conditions. Junction temperature will exceed 125°C when overtemperature protection is active. Continuous operation above the specified maximum operating junction temperature may impair device reliability.

TYPICAL PERFORMANCE CHARACTERISTICS (Per Channel)

Efficiency vs Load Current from 5V_{IN} (One Channel Operating)

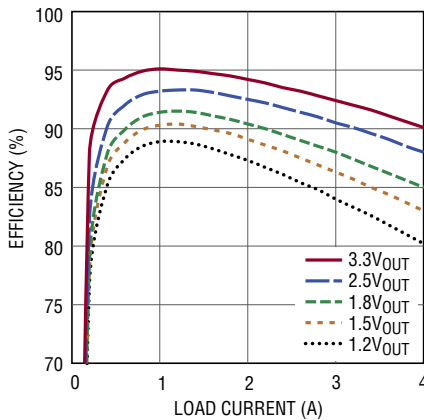

Efficiency vs Load Current from 12V_{IN} (One Channel Operating)

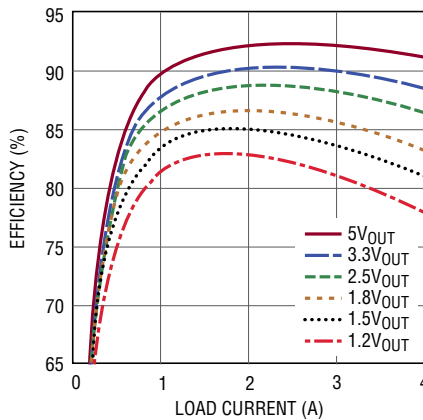

DCM Mode Efficiency from 1.5V_{OUT}

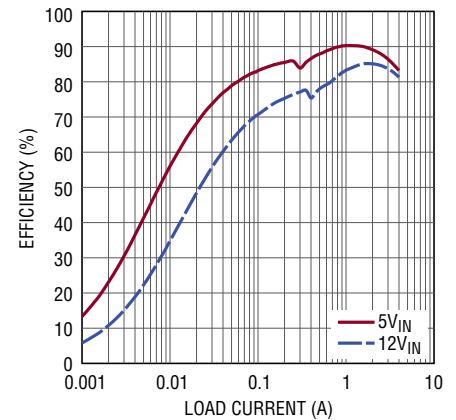

1.0V Output Transient Response

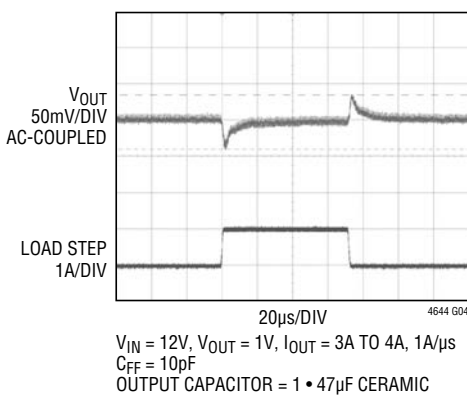

1.5V Output Transient Response

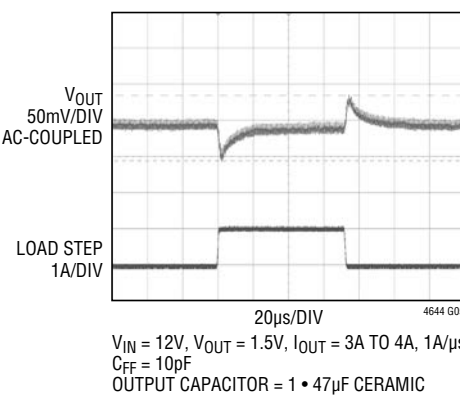

2.5V Output Transient Response

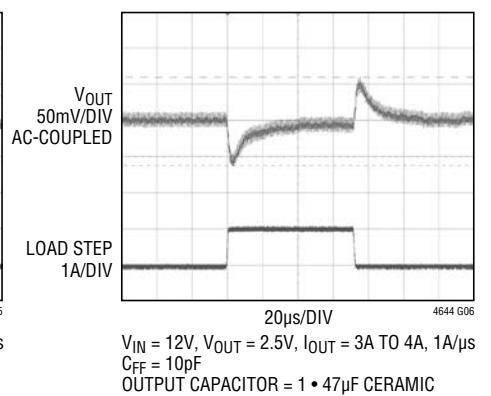

TYPICAL PERFORMANCE CHARACTERISTICS

3.3V Output Transient Response

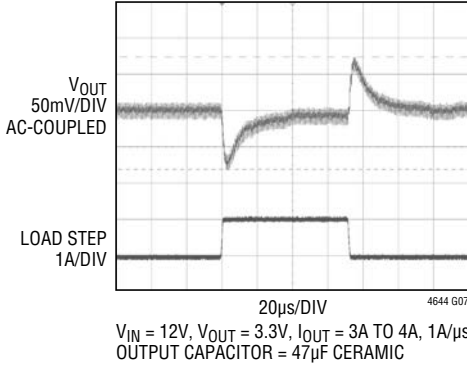

5V Output Transient Response

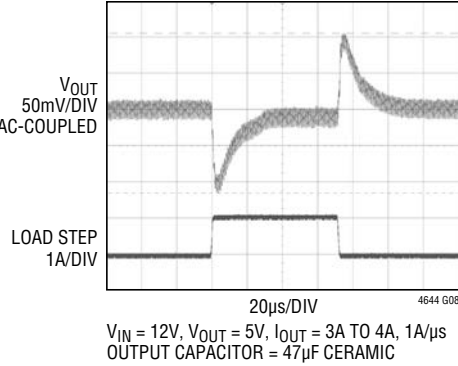

Start-Up with No Load

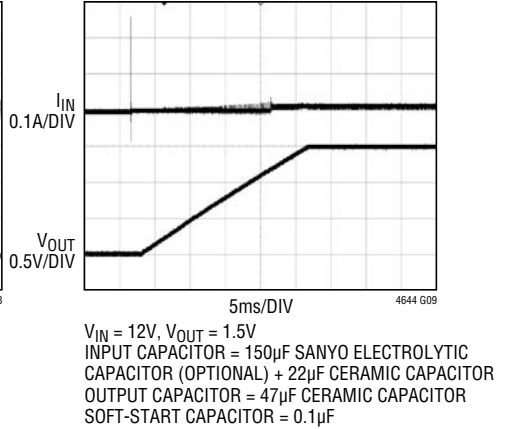

Start-Up with 4A Load

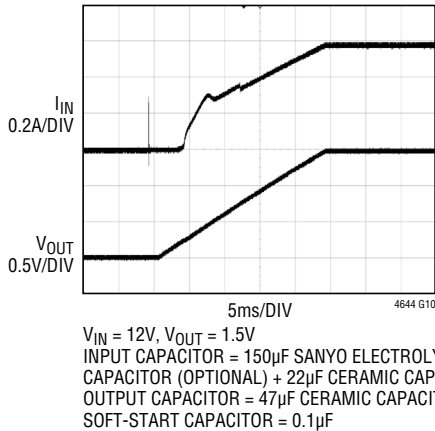

Short-Circuit with No Load

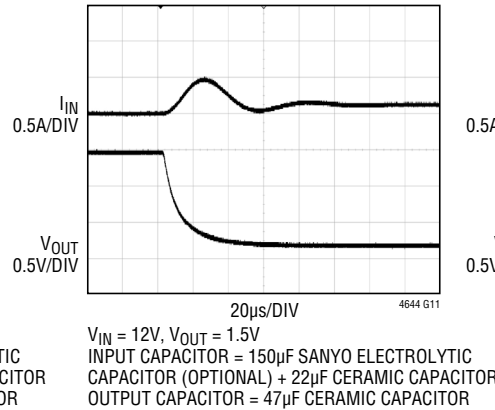

Short-Circuit with 4A Load

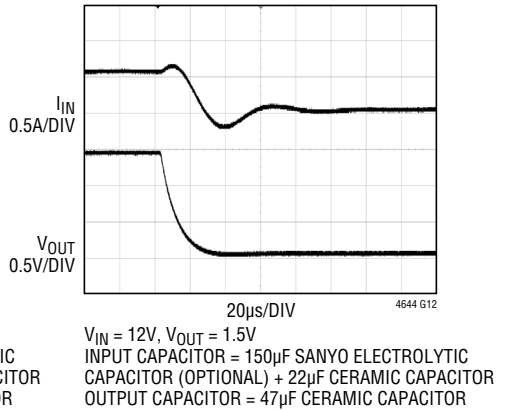

Recovery to No Load from Short-Circuit

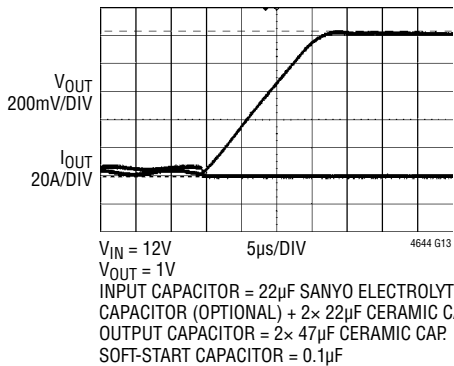

Output Ripple

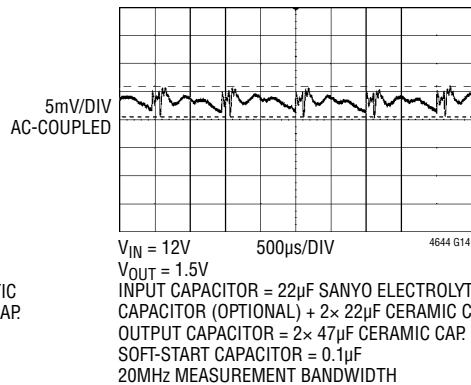

Start Into Pre-Biased Output

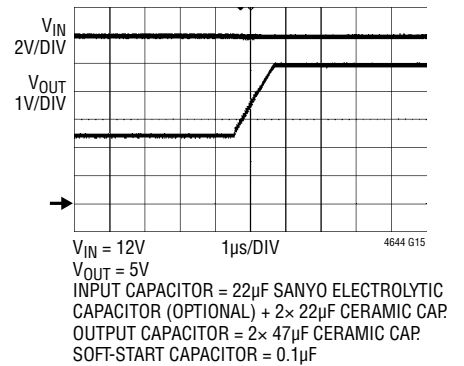

PIN FUNCTIONS



PACKAGE ROW AND COLUMN LABELING MAY VARY AMONG μ Module PRODUCTS. REVIEW EACH PACKAGE LAYOUT CAREFULLY.

V_{OUT1} (A1, A2, A3), V_{OUT2} (C1, D1, D2), V_{OUT3} (F1, G1, G2), V_{OUT4} (J1, K1, K2): Power Output Pins of Each Switching Mode Regulator Channel. Apply output load between these pins and GND pins. Recommend placing output decoupling capacitance directly between these pins and GND pins. See the Applications Information section for paralleling outputs.

GND (A4-A5, B1-B2, C5, D3-D5, E1-E2, F5, G3-G5, H1-H2, J5, K3-K4, L1-L2): Power Ground Pins for Both Input and Output Returns. Use large PCB copper areas to connect all GND together.

V_{IN1} (B3, B4), V_{IN2} (E3, E4), V_{IN3} (H3, H4), V_{IN4} (L3, L4): Power input pins connect to the drain of the internal top MOSFET for each switching mode regulator channel. Apply input voltages between these pins and GND pins. Recommend placing input decoupling capacitance directly between each of V_{IN} pins and GND pins.

PGOOD1, PGOOD2, PGOOD3, PGOOD4 (C3, C2, F2, J2): Output Power Good with Open-Drain Logic of Each Switching Mode Regulator Channel. PGOOD is pulled to ground when the voltage on the FB pin is not within $\pm 10\%$ of the internal 0.6V reference.

CLKOUT (J3): Output Clock Signal for PolyPhase[®] Operation of the Module. The phase of CLKOUT with respect to CLKIN is set to 180°. CLKOUT's peak-to-peak amplitude is INTV_{CC} to GND. See the Application Information section for details. Strictly output; do not drive this pin.

INTV_{CC1}, INTV_{CC2}, INTV_{CC3}, INTV_{CC4} (C4, F4, J4, K5): Internal 3.3V Regulator Output of Each Switching Mode Regulator Channel. The internal power drivers and control circuits are powered from this voltage. Each pin is internally decoupled to GND with 1 μ F low ESR ceramic capacitor already.

SV_{IN1}, SV_{IN2}, SV_{IN}, SV_{IN4} (B5, E5, H5, L5): Signal V_{IN}. Filtered input voltage to the internal 3.3V regulator for the control circuitry of each Switching mode Regulator Channel. Tie this pin to the V_{IN} pin respectively in most applications. Connect SV_{IN} to an external voltage supply of at least 4V which must also be greater than V_{OUT}.

TRACK/SS1, TRACK/SS2, TRACK/SS3, TRACK/SS4 (A6, D6, G6, K6): Output Tracking and Soft-Start Pin of Each Switching Mode Regulator Channel. Allows the user to control the rise time of the output voltage. Putting a voltage below 0.6V on this pin bypasses the internal reference input to the error amplifier, instead it servos the FB pin to match the TRACK voltage. Above 0.6V, the tracking function stops and the internal reference resumes control of the error amplifier. There's an internal 2.5 μ A pull-up current from INTV_{CC} on this pin, so putting a capacitor here provides soft-start function.

MODE1, MODE2, MODE3, MODE4 (B6, E6, H6, L6): Operation Mode Select for Each Switching Mode Regulator Channel. Tie this pin to INTV_{CC} to force continuous synchronous operation at all output loads. Tying it to SGND enables discontinuous current mode operation at light loads. Do not leave floating.

RUN1, RUN2, RUN3, RUN4 (C6, F6, J6, K7): Run Control Input of Each Switching Mode Regulator Channel. Enable regulator operation by tying the specific RUN pin above 1.2V. Pulling it below 1.1V shuts down the respective regulator channel. Do not leave floating.

FB1, FB2, FB3, FB4 (A7, D7, G7, J7): The Negative Input of the Error Amplifier for Each Switching Mode Regulator Channel. Internally, in LTM4644, this pin is connected to V_{OUT} of each channel with a 60.4k Ω precision resistor. Different output voltages can be programmed with an additional resistor between the FB and GND pins for the LTM4644, and two resistors between the V_{OUT}, FB and GND pins for the LTM4644-1. In PolyPhase operation, tying the FB pins together allows for parallel operation. See the Applications Information section for details.

PIN FUNCTIONS

COMP1, COMP2, COMP3, COMP4 (B7, E7, H7, L7): Current Control Threshold and Error Amplifier Compensation Point of Each Switching Mode Regulator Channel. The internal current comparator threshold is proportional to this voltage. Tie the COMP pins together for parallel operation. The device is internally compensated.

CLKIN (C7): External Synchronization Input to Phase Detector of the Module. This pin is internally terminated to SGND with 20k Ω . The phase-locked loop will force the channel 1 turn-on signal to be synchronized with the rising edge of the CLKIN signal. Channel 2, channel 3 and channel 4 will also be synchronized with the rising edge of the CLKIN signal with a pre-determined phase shift. See the Applications Information section for details.

SGND (F7): Signal Ground Connection. SGND is connected to GND internally through single point. Use a separated SGND ground copper area for the ground of the feedback resistor and other components connected to signal pins. A second connection between the PGND plane and SGND plane is recommended on the backside of the PCB underneath the module.

TEMP (F3): Onboard Temperature Diode for Monitoring the VBE Junction Voltage Change with Temperature. See the Applications Information section.

LTM4644/LTM4644-1

BLOCK DIAGRAM

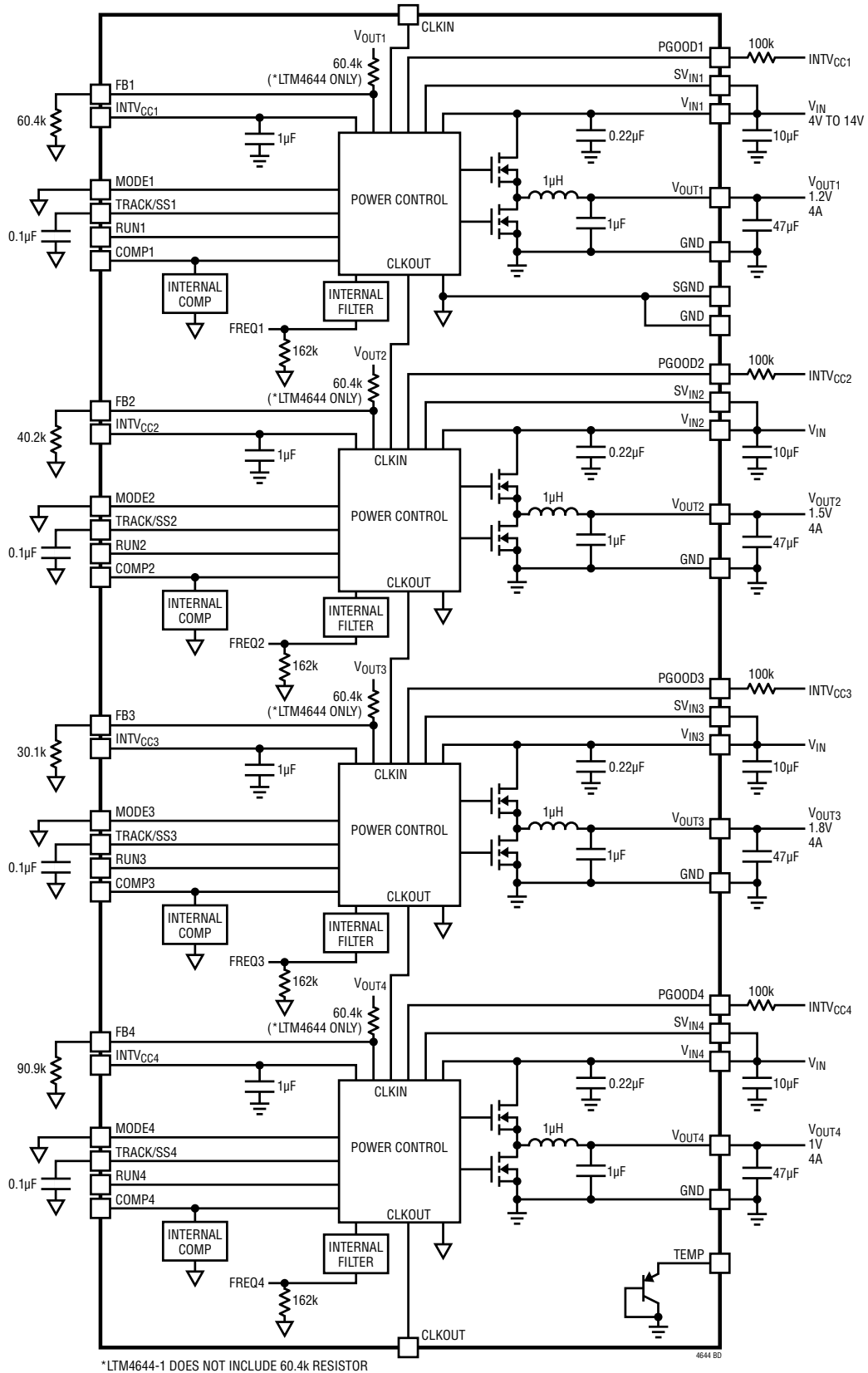

DECOUPLING REQUIREMENTS (per Channel)

SYMBOL	PARAMETER	CONDITIONS	MIN	TYP	MAX	UNITS
C _{IN}	External Input Capacitor Requirement (V _{IN} = 4V to 14V, V _{OUT} = 1.5V)	I _{OUT} = 4A	4.7	10		μF
C _{OUT}	External Output Capacitor Requirement (V _{IN} = 4V to 14V, V _{OUT} = 1.5V)	I _{OUT} = 4A	22	47		μF

OPERATION

The LTM4644 is a quad output standalone non-isolated switch mode DC/DC power supply. It has four separate regulator channels with each of them capable of delivering up to 4A continuous output current with few external input and output capacitors. Each regulator provides precisely regulated output voltage programmable from 0.6V to 5.5V via a single external resistor (two resistors for LTM4644-1) over 4V to 14V input voltage range. With an external bias voltage, this module can operate from an input voltage as low as 2.375V. The typical application schematic is shown in Figure 33.

The LTM4644 integrates four separate constant frequency controlled on-time valley current mode regulators, power MOSFETs, inductors, and other supporting discrete components. The typical switching frequency is set to 1MHz. For switching noise-sensitive applications, the μModule regulator can be externally synchronized to a clock from 700kHz to 1.3MHz. See the Applications Information section.

With current mode control and internal feedback loop compensation, the LTM4644 module has sufficient stability margins and good transient performance with a wide range of output capacitors, even with all ceramic output capacitors.

Current mode control provides the flexibility of paralleling any of the separate regulator channels with accurate current sharing. With a built-in clock interleaving between each two regulator channels, the LTM4644 could easily

employ a 2+2, 3+1 or 4 channels parallel operation which is more than flexible in a multirail POL application like FPGA. Furthermore, the LTM4644 has CLKIN and CLKOUT pins for frequency synchronization or polyphasing multiple devices which allow up to 8 phases cascaded to run simultaneously.

Current mode control also provides cycle-by-cycle fast current monitoring. Foldback current limiting is provided in an overcurrent condition to reduce the inductor valley current to approximately 40% of the original value when V_{FB} drops. An internal overvoltage and undervoltage comparators pull the open-drain PGOOD output low if the output feedback voltage exits a ±10% window around the regulation point. Continuous conduction mode (CCM) operation is forced during OV and UV conditions except during start-up when the TRACK pin is ramping up to 0.6V.

Pulling the RUN pin below 1.1V forces the controller into its shutdown state, turning off both power MOSFETs and most of the internal control circuitry. At light load currents, discontinuous conduction mode (DCM) operation can be enabled to achieve higher efficiency compared to continuous conduction mode (CCM) by setting the MODE pin to SGND. The TRACK/SS pin is used for power supply tracking and soft-start programming. See the Applications Information section.

A temperature diode is included inside the module to monitor the temperature of the module. See the Applications Information section for details.

APPLICATIONS INFORMATION

The typical LTM4644 application circuit is shown in Figure 33. External component selection is primarily determined by the input voltage, the output voltage and the maximum load current. Refer to Table 7 for specific external capacitor requirements for a particular application.

V_{IN} to V_{OUT} Step-Down Ratios

There are restrictions in the maximum V_{IN} and V_{OUT} step-down ratio that can be achieved for a given input voltage due to the minimum off-time and minimum on-time limits of each regulator. The minimum off-time limit imposes a maximum duty cycle which can be calculated as:

$$D_{MAX} = 1 - t_{OFF(MIN)} \cdot f_{SW}$$

where t_{OFF(MIN)} is the minimum off-time, 70ns typical for LTM4644, and f_{SW} is the switching frequency. Conversely the minimum on-time limit imposes a minimum duty cycle of the converter which can be calculated as:

$$D_{MIN} = t_{ON(MIN)} \cdot f_{SW}$$

where t_{ON(MIN)} is the minimum on-time, 40ns typical for LTM4644. In the rare cases where the minimum duty cycle is surpassed, the output voltage will still remain in regulation, but the switching frequency will decrease from its programmed value. Note that additional thermal derating may be applied. See the Thermal Considerations and Output Current Derating section in this data sheet.

Output Voltage Programming (LTM4644)

The PWM controller has an internal 0.6V reference voltage. As shown in the Block Diagram, a 60.4k internal feedback resistor connects each regulator channel from V_{OUT} pin to FB pin. Adding a resistor R_{FB(BOT)} from FB pin to GND programs the output voltage:

$$R_{FB(BOT)} = \frac{60.4k}{\frac{V_{OUT}}{0.6} - 1}$$

Table 1. V_{FB} Resistor Table vs Various Output Voltages

V _{OUT} (V)	0.6	1.0	1.2	1.5	1.8	2.5	3.3	5.0
R _{FB(BOT)} (k)	Open	90.9	60.4	40.2	30.1	19.1	13.3	8.25

For parallel operation of N channels, use the following equation can be used to solve for R_{FB(BOT)}. Tie the V_{OUT} and the FB and COMP pins together for each paralleled output with a single resistor to GND as determined by:

$$R_{FB(BOT)} = \frac{\left(\frac{60.4k}{N}\right)}{\left(\frac{V_{OUT}}{0.6} - 1\right)}$$

OUTPUT VOLTAGE PROGRAMMING (LTM4644-1)

The PWM controller has an internal 0.6V reference voltage. Adding two resistors R_{FB(TOP)} from V_{OUT} to FB pin and R_{FB(BOT)} from FB pin to GND programs the output voltage:

$$R_{FB(BOT)} = \frac{R_{FB(TOP)}}{\frac{V_{OUT}}{0.6} - 1}$$

For parallel operation of N Channels, only one set of R_{FB(TOP)} and R_{FB(BOT)} is needed while tying the V_{OUT}, FB and COMP pins from different channels together. See Figure 1 for example.

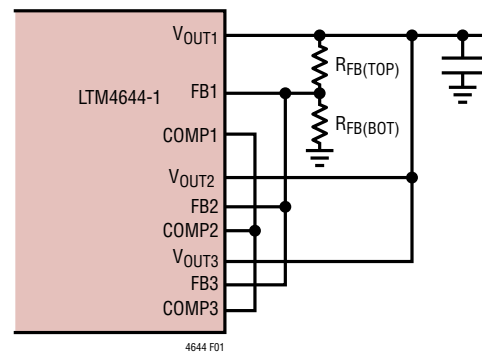

Figure 1. LTM4644-1 Feedback Resistor for Paralleling Application

	LTM4644	LTM4644-1
Top Feedback Resistor from V_{OUT}-to-V_{FB} (one resistor per channel)	Integrated 60.4k 0.5% Resistor	External (to be added on PCB)
Application	General Applications	To Interface with PMBus power system management supervisory ICs such as the LTC2975

APPLICATIONS INFORMATION

Input Decoupling Capacitors

The LTM4644 module should be connected to a low ac-impedance DC source. For each regulator channel, a 10 μ F input ceramic capacitor is recommended for RMS ripple current decoupling. A bulk input capacitor is only needed when the input source impedance is compromised by long inductive leads, traces or not enough source capacitance. The bulk capacitor can be an electrolytic aluminum capacitor or polymer capacitor.

Without considering the inductor ripple current, the RMS current of the input capacitor can be estimated as:

$$I_{\text{CIN(RMS)}} = \frac{I_{\text{OUT(MAX)}}}{\eta\%} \cdot \sqrt{D \cdot (1-D)}$$

where $\eta\%$ is the estimated efficiency of the power module.

Output Decoupling Capacitors

With an optimized high frequency, high bandwidth design, only single piece of low ESR output ceramic capacitor is required for each regulator channel to achieve low output voltage ripple and very good transient response. Additional output filtering may be required by the system designer, if further reduction of output ripples or dynamic transient spikes is required. Table 7 shows a matrix of different output voltages and output capacitors to minimize the voltage droop and overshoot during a 2A load step transient. Multiphase operation will reduce effective output ripple as a function of the number of phases. Application Note 77 discusses this noise reduction versus output ripple current cancellation, but the output capacitance will be more a function of stability and transient response. The LTpowerCAD™ Design Tool is available to download online for output ripple, stability and transient response analysis and calculating the output ripple reduction as the number of phases implemented increases by N times.

Discontinuous Conduction Mode (DCM)

In applications where low output ripple and high efficiency at intermediate current are desired, discontinuous conduction mode (DCM) should be used by connecting the MODE pin to SGND. At light loads the internal current

comparator may remain tripped for several cycles and force the top MOSFET to stay off for several cycles, thus skipping cycles. The inductor current does not reverse in this mode.

Force Continuous Conduction Mode (CCM)

In applications where fixed frequency operation is more critical than low current efficiency, and where the lowest output ripple is desired, forced continuous conduction mode operation should be used. Forced continuous operation can be enabled by tying the MODE pin to INTV_{CC}. In this mode, inductor current is allowed to reverse during low output loads, the COMP voltage is in control of the current comparator threshold throughout, and the top MOSFET always turns on with each oscillator pulse. During start-up, forced continuous mode is disabled and inductor current is prevented from reversing until the LTM4644's output voltage is in regulation.

Operating Frequency

The operating frequency of the LTM4644 is optimized to achieve the compact package size and the minimum output ripple voltage while still keeping high efficiency. The default operating frequency is internally set to 1MHz. In most applications, no additional frequency adjusting is required.

If any operating frequency other than 1MHz is required by application, the μ Module regulator can be externally synchronized to a clock from 700kHz to 1.3MHz.

Frequency Synchronization and Clock In

The power module has a phase-locked loop comprised of an internal voltage controlled oscillator and a phase detector. This allows all internal top MOSFET turn-on to be locked to the rising edge of the same external clock. The external clock frequency range must be within $\pm 30\%$ around the 1MHz set frequency. A pulse detection circuit is used to detect a clock on the CLKIN pin to turn on the phase-locked loop. The pulse width of the clock has to be at least 400ns. The clock high level must be above 2V and clock low level below 0.3V. During the start-up of the regulator, the phase-locked loop function is disabled.

APPLICATIONS INFORMATION

Multichannel Parallel Operation

For loads that demand more than 4A of output current, the LTM4644 multiple regulator channels can be easily paralleled to provide more output current without increasing input and output voltage ripples. The LTM4644 has preset built-in phase shift between each two of the four regulator channels which is suitable to employ a 2+2, 3+1 or 4 channels parallel operation. Table 2 gives the phase difference between regulator channels.

Table 2. Phase Difference Between Regulator Channels

CHANNEL	CH1	CH2	CH3	CH4
Phase Difference	180°	90°	180°	

Figure 2 shows a 2+2 and a 4-channels parallel concept schematic for clock phasing.

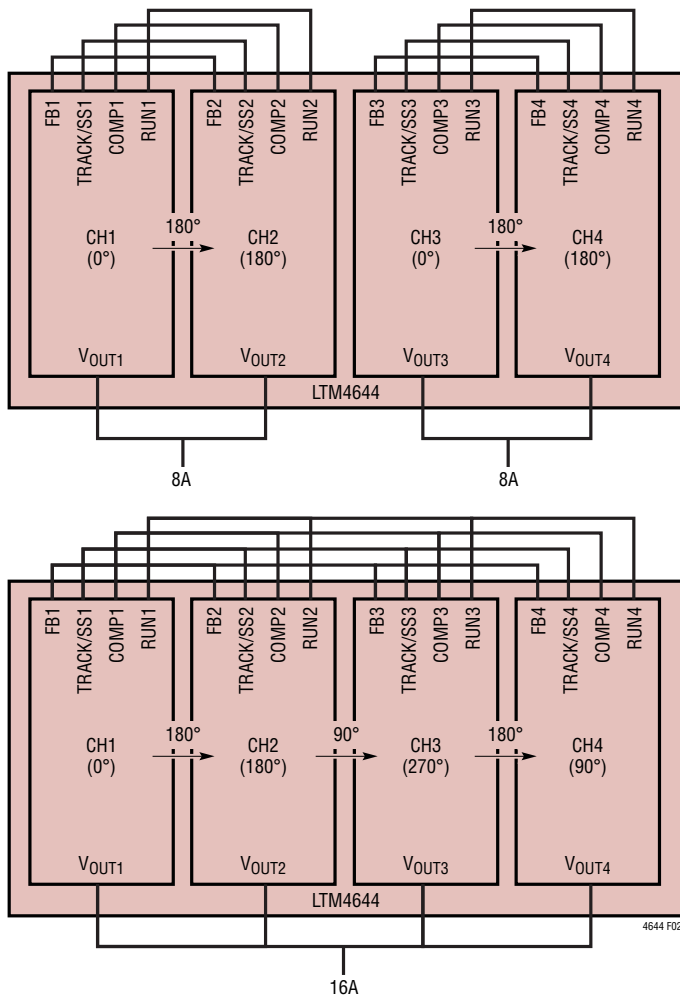

Figure 2. 2+2 and 4 Channels Parallel Concept Schematic

A multiphase power supply significantly reduces the amount of ripple current in both the input and output capacitors. The RMS input ripple current is reduced by, and the effective ripple frequency is multiplied by, the number of phases used (assuming that the input voltage is greater than the number of phases used times the output voltage). The output ripple amplitude is also reduced by the number of phases used when all of the outputs are tied together to achieve a single high output current design.

The LTM4644 device is an inherently current mode controlled device, so parallel modules will have very good current sharing. This will balance the thermals on the design. Please tie the RUN, TRACK/SS, FB and COMP pins of each paralleling channel together. Figure 35 and Figure 36 shows an example of parallel operation and pin connection.

Input RMS Ripple Current Cancellation

Application Note 77 provides a detailed explanation of multiphase operation. The input RMS ripple current cancellation mathematical derivations are presented, and a graph is displayed representing the RMS ripple current reduction as a function of the number of interleaved phases. Figure 3 shows this graph.

Soft-Start and Output Voltage Tracking

The TRACK/SS pin provides a means to either soft-start of each regulator channel or track it to a different power supply. A capacitor on the TRACK/SS pin will program the ramp rate of the output voltage. An internal 2.5µA current source will charge up the external soft-start capacitor towards the INTV_{CC} voltage. When the TRACK/SS voltage is below 0.6V, it will take over the internal 0.6V reference voltage to control the output voltage. The total soft-start time can be calculated as:

$$t_{SS} = 0.6 \cdot \frac{C_{SS}}{2.5\mu A}$$

where C_{SS} is the capacitance on the TRACK/SS pin. Current foldback and forced continuous mode are disabled during the soft-start process.

APPLICATIONS INFORMATION

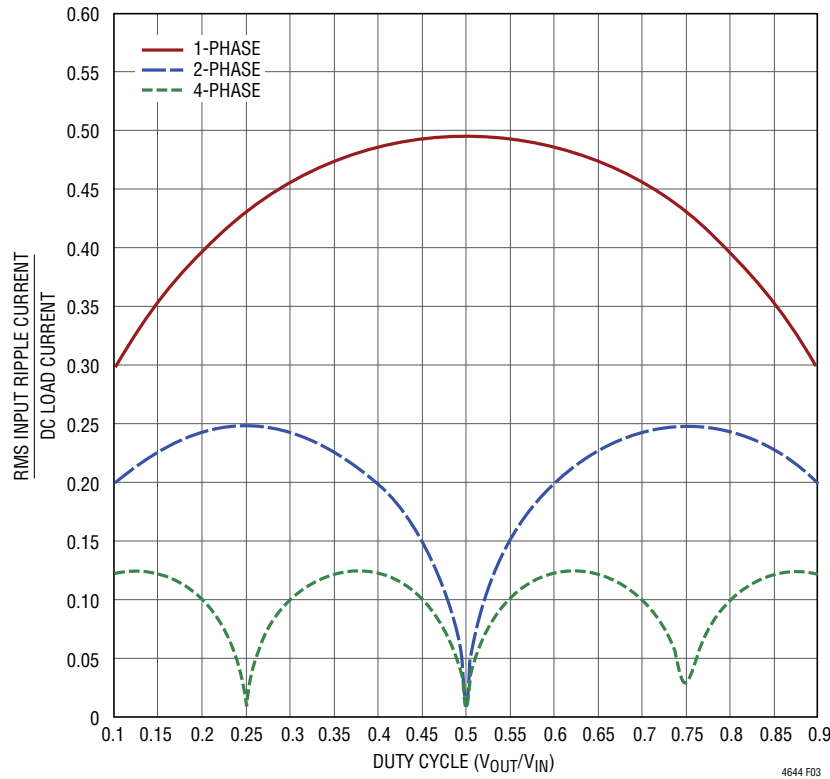

Figure 3. Normalized RMS Ripple Current for Single Phase or Polyphase Applications

Output voltage tracking can also be programmed externally using the TRACK/SS pin of each regulator channel. The output can be tracked up and down with another regulator. Figure 4 and Figure 5 show an example waveform and schematic of a ratiometric tracking where the slave regulator's (V_{OUT2} , V_{OUT3} and V_{OUT4}) output slew rate is proportional to the master's (V_{OUT1}).

Since the slave regulator's TRACK/SS is connected to the master's output through a $R_{TR(TOP)}/R_{TR(BOT)}$ resistor divider and its voltage used to regulate the slave output voltage when TRACK/SS voltage is below 0.6V, the slave output voltage and the master output voltage should satisfy the following equation during the start-up.

$$V_{OUT(SL)} \cdot \frac{R_{FB(SL)}}{R_{FB(SL)} + 60.4k} = V_{OUT(MA)} \cdot \frac{R_{TR(BOT)}}{R_{TR(TOP)} + R_{TR(BOT)}}$$

Where the 60.4k is the integrated top feedback resistor and the $R_{FB(SL)}$ is the external bottom feedback resistor of the LTM4644. The $R_{TR(TOP)}/R_{TR(BOT)}$ is the resistor divider on the TRACK/SS pin of the slave regulator, as shown in Figure 5.

Following the upper equation, the master's output slew rate (MR) and the slave's output slew rate (SR) in volts/time is determined by:

$$\frac{MR}{SR} = \frac{\frac{R_{FB(SL)}}{R_{FB(SL)} + 60.4k}}{\frac{R_{TR(BOT)}}{R_{TR(TOP)} + R_{TR(BOT)}}$$

APPLICATIONS INFORMATION

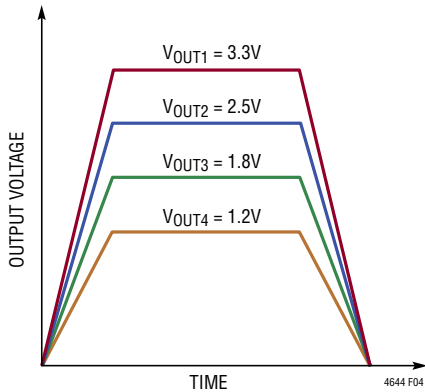

Figure 4. Output Ratiometric Tracking Waveform

The TRACK pins will have the 2.5µA current source on when a resistive divider is used to implement tracking on that specific channel. This will impose an offset on the TRACK pin input. Smaller value resistors with the same ratios as the resistor values calculated from the above equation can be used. For example, where the 60.4k is used then a 6.04k can be used to reduce the TRACK pin offset to a negligible value.

The coincident output tracking can be recognized as a special ratiometric output tracking which the master's output slew rate (MR) is the same as the slave's output slew rate (SR), as waveform shown in Figure 6.

Forexample, $V_{OUT(MA)} = 3.3V$, $MR = 3.3V/24ms$ and $V_{OUT(SL)} = 1.2V$, $SR = 1.2V/24ms$ as V_{OUT1} and V_{OUT4} shown in Figure 5. From the equation, we could solve out that $R_{TR4(TOP)} = 60.4k$ and $R_{TR4(BOT)} = 13.3k$ is a good combination. Follow the same equation, we can get the same $R_{TR(TOP)}/R_{TR(BOT)}$ resistor divider value for V_{OUT2} and V_{OUT3} .

From the equation we could easily find out that, in the coincident tracking, the slave regulator's TRACK/SS pin resistor divider is always the same as its output voltage divider.

$$\frac{R_{FB(SL)}}{R_{FB(SL)} + 60.4k} = \frac{R_{TR(BOT)}}{R_{TR(TOP)} + R_{TR(BOT)}}$$

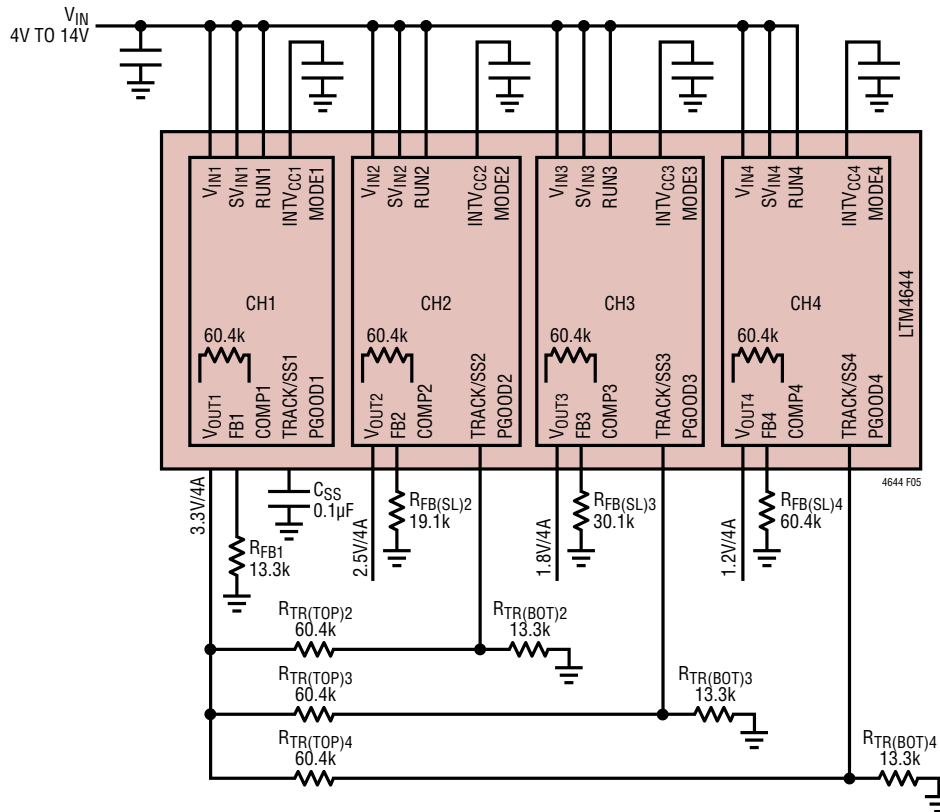

Figure 5. Output Ratiometric Tracking Schematic

APPLICATIONS INFORMATION

For example, $R_{TR4(TOP)} = 60.4k$ and $R_{TR4(BOT)} = 60.4k$ is a good combination for coincident tracking for $V_{OUT(MA)} = 3.3V$ and $V_{OUT(SL)} = 1.2V$ application.

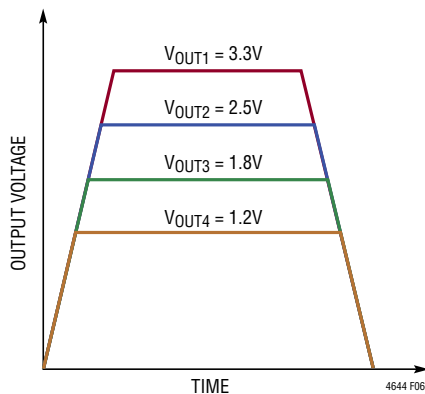

Figure 6. Output Coincident Tracking Waveform

Power Good

The PGOOD pins are open drain pins that can be used to monitor each valid output voltage regulation. This pin monitors a $\pm 10\%$ window around the regulation point. A resistor can be pulled up to a particular supply voltage for monitoring. To prevent unwanted PGOOD glitches during transients or dynamic V_{OUT} changes, the LTM4644's PGOOD falling edge includes a blanking delay of approximately 52 switching cycles.

Stability Compensation

The LTM4644 module internal compensation loop of each regulator channel is designed and optimized for low ESR ceramic output capacitors only application. Table 6 is provided for most application requirements. In case of bulk output capacitors is required for output ripples or dynamic transient spike reduction, an additional 10pF to 15pF phase boost capacitor is required between the V_{OUT} and FB pins. The LTpowerCAD Design Tool is available to download for control loop optimization.

RUN Enable

Pulling the RUN pin of each regulator channel to ground forces the regulator into its shutdown state, turning off both power MOSFETs and most of its internal control circuitry. Bringing the RUN pin above 0.7V turns on the internal

reference only, while still keeping the power MOSFETs off. Further increasing the RUN pin voltage above 1.2V will turn on the entire regulator channel.

Pre-Biased Output Start-Up

There may be situations that require the power supply to start up with some charge on the output capacitors. The LTM4644 can safely power up into a pre-biased output without discharging it.

The LTM4644 accomplishes this by forcing discontinuous mode (DCM) operation until the TRACK/SS pin voltage reaches 0.6V reference voltage. This will prevent the BG from turning on during the pre-biased output start-up which would discharge the output.

Do not pre-bias LTM4644 with an output voltage higher than $INTV_{CC}$ (3.3V).

Overtemperature Protection

The internal overtemperature protection monitors the junction temperature of the module. If the junction temperature reaches approximately $160^{\circ}C$, both power switches will be turned off until the temperature drops about $15^{\circ}C$ cooler.

Low Input Application

The LTM4644 module has a separate SV_{IN} pin for each regulator channel which makes it compatible with operation from an input voltage as low as 2.375V. The SV_{IN} pin is the signal input of the regulator control circuitry while the V_{IN} pin is the power input which directly connected to the drain of the top MOSFET. In most application with input voltage ranges from 4V to 14V, connect the SV_{IN} pin directly to the V_{IN} pin of each regulator channel. An optional filter, consisting of a resistor (1Ω to 10Ω) between SV_{IN} and V_{IN} ground, can be placed for additional noise immunity. This filter is not necessary in most cases if good PCB layout practices are followed (see Figure 32). In a low input voltage (2.375V to 4V) application, or to reduce power dissipation by the internal bias LDO, connect SV_{IN} to an external voltage higher than 4V with a $0.1\mu F$ local bypass capacitor. Figure 34 shows an example of a low input voltage application. Please note, SV_{IN} voltage cannot go below V_{OUT} voltage.

APPLICATIONS INFORMATION

Temperature Monitoring

A diode connected PNP transistor is used for the TEMP monitor function by monitoring its voltage over temperature. The temperature dependence of this diode voltage can be understood in the equation:

$$V_D = nV_T \ln\left(\frac{I_D}{I_S}\right)$$

where V_T is the thermal voltage (kT/q), and n , the ideality factor, is 1 for the diode connected PNP transistor being used in the LTM4644. I_S is expressed by the typical empirical equation:

$$I_S = I_0 \exp\left(\frac{-V_{G0}}{V_T}\right)$$

where I_0 is a process and geometry dependent current, (I_0 is typically around 20k orders of magnitude larger than I_S at room temperature) and V_{G0} is the band gap voltage of 1.2V extrapolated to absolute zero or -273°C .

If we take the I_S equation and substitute into the V_D equation, then we get:

$$V_D = V_{G0} - \left(\frac{kT}{q}\right) \ln\left(\frac{I_0}{I_D}\right), \quad V_T = \frac{kT}{q}$$

The expression shows that the diode voltage decreases (linearly if I_0 were constant) with increasing temperature and constant diode current. Figure 6 shows a plot of V_D vs Temperature over the operating temperature range of the LTM4644.

If we take this equation and differentiate it with respect to temperature T , then:

$$\frac{dV_D}{dT} = -\frac{V_{G0} - V_D}{T}$$

This dV_D/dT term is the temperature coefficient equal to about -2mV/K or $-2\text{mV}/^\circ\text{C}$. The equation is simplified for the first order derivation.

Solving for T , $T = -(V_{G0} - V_D)/(dV_D/dT)$ provides the temperature.

1st Example: Figure 7 for 27°C , or 300K the diode voltage is 0.598V, thus, $300\text{K} = -(1200\text{mV} - 598\text{mV})/ -2.0\text{mV/K}$

2nd Example: Figure 7 for 75°C , or 350K the diode voltage is 0.50V, thus, $350\text{K} = -(1200\text{mV} - 500\text{mV})/ -2.0\text{mV/K}$

Converting the Kelvin scale to Celsius is simply taking the Kelvin temp and subtracting 273 from it.

A typical forward voltage is given in the electrical characteristics section of the data sheet, and Figure 7 is the plot of this forward voltage. Measure this forward voltage at 27°C to establish a reference point. Then using the above expression while measuring the forward voltage over temperature will provide a general temperature monitor. Connect a resistor between TEMP and V_{IN} to set the current to $100\mu\text{A}$. See Figure 35 for an example.

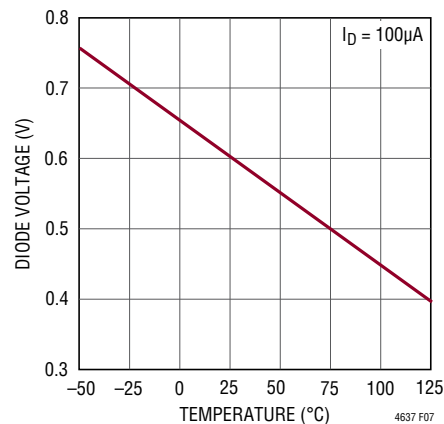

Figure 7. Diode Voltage V_D vs Temperature $T(^{\circ}\text{C})$

Thermal Considerations and Output Current Derating

The thermal resistances reported in the Pin Configuration section of the data sheet are consistent with those parameters defined by JESD 51-12 and are intended for use with finite element analysis (FEA) software modeling tools that leverage the outcome of thermal modeling, simulation, and correlation to hardware evaluation performed on a μModule package mounted to a hardware test board: defined by JESD 51-9 ("Test Boards for Area

APPLICATIONS INFORMATION

Array Surface Mount Package Thermal Measurements”). The motivation for providing these thermal coefficients is found in JESD 51-12 (“Guidelines for Reporting and Using Electronic Package Thermal Information”).

Many designers may opt to use laboratory equipment and a test vehicle such as the demo board to predict the μ Module regulator’s thermal performance in their application at various electrical and environmental operating conditions to compliment any FEA activities. Without FEA software, the thermal resistances reported in the Pin Configuration section are in-and-of themselves not relevant to providing guidance of thermal performance; instead, the derating curves provided in this data sheet can be used in a manner that yields insight and guidance pertaining to one’s application-usage, and can be adapted to correlate thermal performance to one’s own application.

The Pin Configuration section typically gives four thermal coefficients explicitly defined in JESD 51-12; these coefficients are quoted or paraphrased below:

1. θ_{JA} , the thermal resistance from junction to ambient, is the natural convection junction-to-ambient air thermal resistance measured in a one cubic foot sealed enclosure. This environment is sometimes referred to as “still air” although natural convection causes the air to move. This value is determined with the part mounted to a JESD 51-9 defined test board, which does not reflect an actual application or viable operating condition.
2. $\theta_{JCbottom}$, the thermal resistance from junction to the bottom of the product case, is determined with all of the component power dissipation flowing through the bottom of the page. In the typical μ Module regulator, the bulk of the heat flows out the bottom of the package, but there is always heat flow out into the ambient environment. As a result, this thermal resistance value may be useful for comparing packages but the test conditions don’t generally match the user’s application.
3. θ_{JCTop} , the thermal resistance from junction to top of the product case, is determined with nearly all of the component power dissipation flowing through the top of the package. As the electrical connections of the typical μ Module regulator are on the bottom of the package, it is rare for an application to operate such that most of the heat flows from the junction to the top of the part. As in the case of $\theta_{JCbottom}$, this value may be useful for comparing packages but the test conditions don’t generally match the user’s application.
4. θ_{JB} , the thermal resistance from junction to the printed circuit board, is the junction-to-board thermal resistance where almost all of the heat flows through the bottom of the μ Module regulator and into the board, and is really the sum of the $\theta_{JCbottom}$ and the thermal resistance of the bottom of the part through the solder joints and through a portion of the board. The board temperature is measured a specified distance from the package.

A graphical representation of the aforementioned thermal resistances is given in Figure 8; blue resistances are contained within the μ Module regulator, whereas green resistances are external to the μ Module package.

As a practical matter, it should be clear to the reader that no individual or sub-group of the four thermal resistance parameters defined by JESD 51-12 or provided in the Pin Configuration section replicates or conveys normal operating conditions of a μ Module regulator. For example, in normal board-mounted applications, never does 100% of the device’s total power loss (heat) thermally conduct exclusively through the top or exclusively through bottom of the μ Module package—as the standard defines for θ_{JCTop} and $\theta_{JCbottom}$, respectively. In practice, power loss is thermally dissipated in both directions away from the package—granted, in the absence of a heat sink and airflow, a majority of the heat flow is into the board.

Within the LTM4644, be aware there are multiple power devices and components dissipating power, with a consequence that the thermal resistances relative to different junctions of components or die are not exactly linear with respect to total package power loss. To reconcile this complication without sacrificing modeling simplicity—but also, not ignoring practical realities—an approach has been taken using FEA software modeling along with laboratory testing in a controlled-environment chamber to reasonably define and correlate the thermal resistance values supplied in this data sheet: (1) Initially, FEA software

APPLICATIONS INFORMATION

is used to accurately build the mechanical geometry of the LTM4644 and the specified PCB with all of the correct material coefficients along with accurate power loss source definitions; (2) this model simulates a software-defined JEDEC environment consistent with JESD 51-12 to predict power loss heat flow and temperature readings at different interfaces that enable the calculation of the JEDEC-defined thermal resistance values; (3) the model and FEA software is used to evaluate the LTM4644 with heat sink and airflow; (4) having solved for and analyzed these thermal resistance values and simulated various operating conditions in the software model, a thorough laboratory evaluation replicates the simulated conditions with thermocouples within a controlled-environment chamber while operating the device at the same power loss as that which was simulated. An outcome of this process and due diligence yields the set of derating curves shown in this data sheet.

The 1V to 5V power loss curves in Figures 9 to 15 can be used in coordination with the load current derating curves in Figures 16 to 29 for calculating an approximate θ_{JA} thermal resistance for the LTM4644 with various heat sinking and airflow conditions. The power loss curves are taken at room temperature, and are increased with a multiplicative factor according to the junction temperature. This approximate factor is 1.35 for 120°C. The derating curves are plotted with the output current starting at 16A and the ambient temperature at 30°C. These are chosen to include the lower and higher output voltage ranges

for correlating the thermal resistance. Thermal models are derived from several temperature measurements in a controlled temperature chamber along with thermal modeling analysis. The junction temperatures are monitored while ambient temperature is increased with and without airflow. The power loss increase with ambient temperature change is factored into the derating curves. The junctions are maintained at 120°C maximum while lowering output current or power with increasing ambient temperature. The decreased output current will decrease the internal module loss as ambient temperature is increased. The monitored junction temperature of 120°C minus the ambient operating temperature specifies how much module temperature rise can be allowed. As an example in Figure 16 the load current is derated to 9.6A at ~90°C with 400LFM of airflow and no heat sink and the power loss for the 12V to 1.0V at 9.5A output is about 3.2W. The 3.2W loss is calculated with 4 times the 0.6W room temperature loss from the 12V to 1.0V power loss curve each channel at 2.4A, and the 1.35 multiplying factor at 120°C junction. If the 90°C ambient temperature is subtracted from the 120°C junction temperature, then the difference of 30°C divided by 3.2W equals ~9.4°C/W θ_{JA} thermal resistance. Table 3 specifies a 10°C/W value which is very close. Tables 3 to 6 provide equivalent thermal resistances for the different outputs with and without airflow and heat sinking. The derived thermal resistances in Tables 3 to 6 for the various conditions can be multiplied by the calculated power loss as a function of ambient temperature to derive temperature

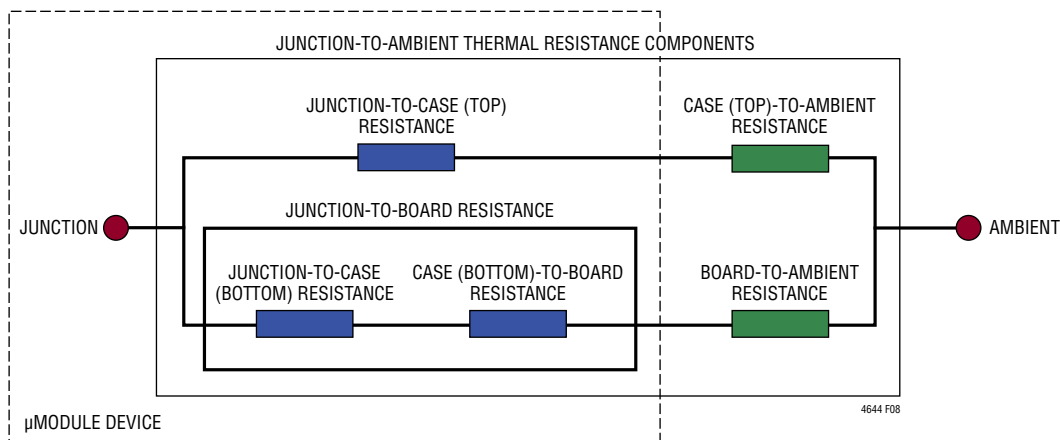

Figure 8. Graphical Representation of JESD 51-12 Thermal Coefficients

APPLICATIONS INFORMATION

rise above ambient, thus maximum junction temperature. Room temperature power loss can be derived from the efficiency curves in the Typical Performance Characteristics section and adjusted with the above junction temperature multiplicative factor. The printed circuit board is a 1.6mm thick four layer board with two ounce copper for the two outer layers and one ounce copper for the two inner layers. The PCB dimensions are 95mm × 76mm.

The 16A represents all four channels in parallel at 4A each. The four parallel channels have their currents reduced at the same rate to develop an equivalent θ_{JA} circuit evaluation with thermal couples or IR camera used to validate the thermal resistance values.

Maximum Operating Ambient Temperature

Figures 30 and 31 display the Maximum Power Loss Allowance Curves vs ambient temperature with various heat sinking and airflow conditions. This data was derived from the thermal impedance generated by various thermal derating examinations with the junction temperature measured at 120°C. This maximum power loss limitation serves as a guideline when designing multiple output rails with different voltages and currents by calculating the total power loss.

For example, to determine the maximum ambient temperature when $V_{OUT1} = 2.5V$ at 0.6A, $V_{OUT2} = 3.3V$ at 3A, $V_{OUT3} = 1.8V$ at 1A, $V_{OUT4} = 1.2V$ at 3A, without a heat sink and 400LFM airflow, simply add up the total power loss for each channel read from Figure 9 to Figure 15 which in this example equals 2.5W, then multiply by the 1.35 coefficient for 120°C junction temperature and compare the total power loss number, 3.4W with Figure 30. Figure 30 indicates with a 3.4W total power loss, the maximum ambient temperature for this particular application is around 86°C. For reference, the actual thermal derating test in the chamber resulted in a maximum ambient temperature of 86.3°C, very close to the calculated value. Also from Figure 30, it is easy to determine with a 3.4W total power loss, the maximum ambient temperature is around 77°C with no airflow and 81°C with 200LFM airflow.

Safety Considerations

The LTM4644 modules do not provide galvanic isolation from V_{IN} to V_{OUT} . There is no internal fuse. If required, a slow blow fuse with a rating twice the maximum input current needs to be provided to protect each unit from catastrophic failure. The device does support thermal shutdown and overcurrent protection.

APPLICATIONS INFORMATION

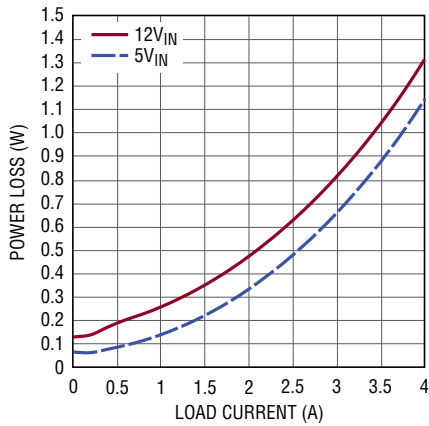

Figure 9. Power Loss at 1.0V Output, (Each Channel, 25°C)

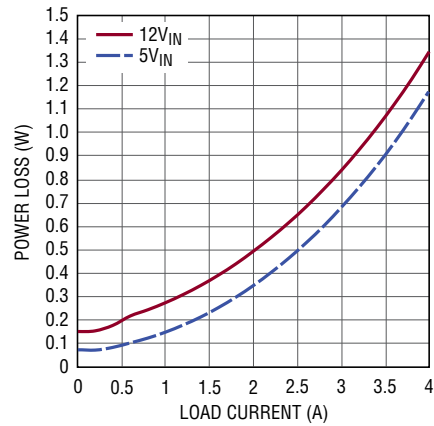

Figure 10. Power Loss at 1.2V Output, (Each Channel, 25°C)

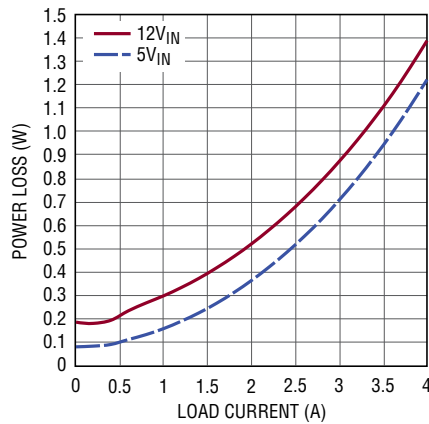

Figure 11. Power Loss at 1.5V Output, (Each Channel, 25°C)

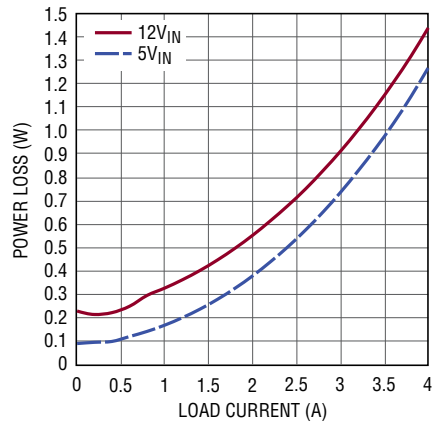

Figure 12. Power Loss at 1.8V Output, (Each Channel, 25°C)

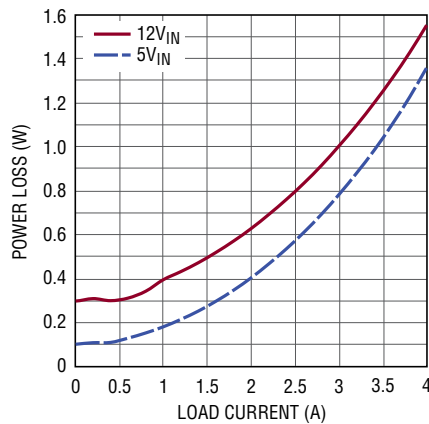

Figure 13. Power Loss at 2.5V Output, (Each Channel, 25°C)

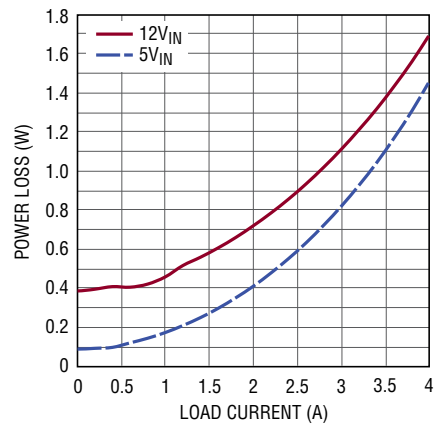

Figure 14. Power Loss at 3.3V Output, (Each Channel, 25°C)

APPLICATIONS INFORMATION

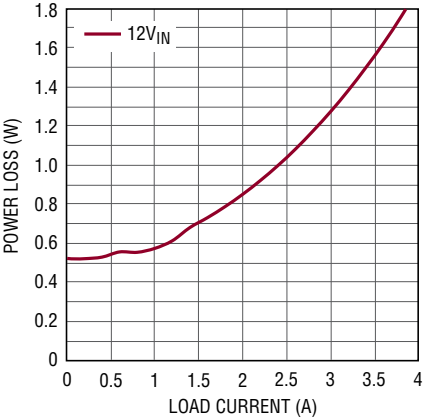

Figure 15. Power Loss at 5V Output, (Each Channel, 25°C)

4641 F15

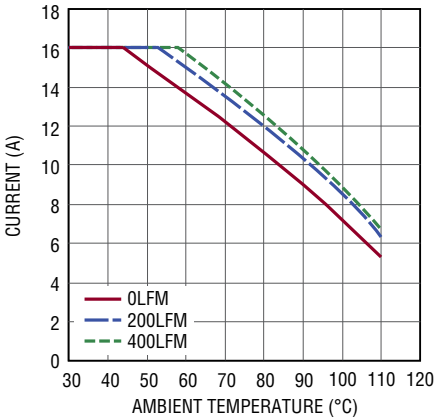

Figure 16. 5V_{IN} to 1.0V_{OUT} Derating Curve 4-Channel Paralleled, No Heat Sink

4641 F16

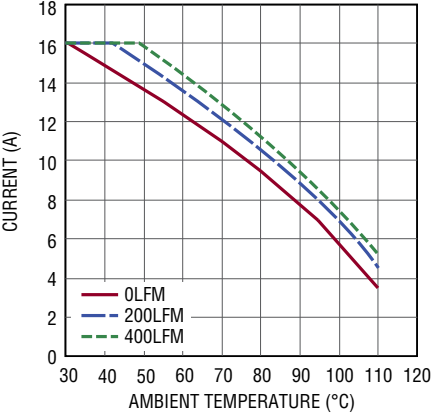

Figure 17. 12V_{IN} to 1.0V_{OUT} Derating Curve 4-Channel Paralleled, No Heat Sink

4641 F17

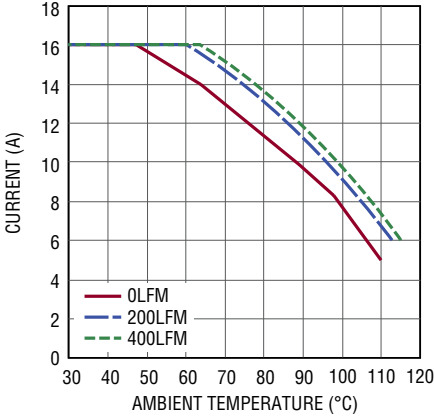

Figure 18. 5V_{IN} to 1.0V_{OUT} Derating Curve 4-Channel Paralleled, BGA Heat Sink

4641 F18

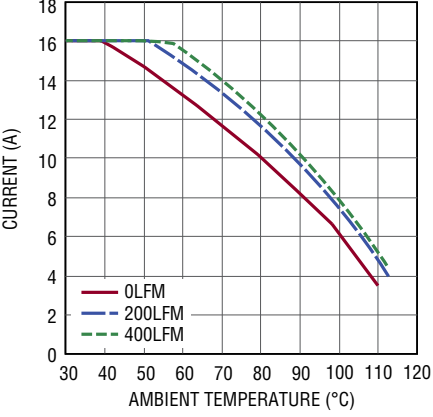

Figure 19. 12V_{IN} to 1.0V_{OUT} Derating Curve 4-Channel Paralleled, BGA Heat Sink

4641 F19

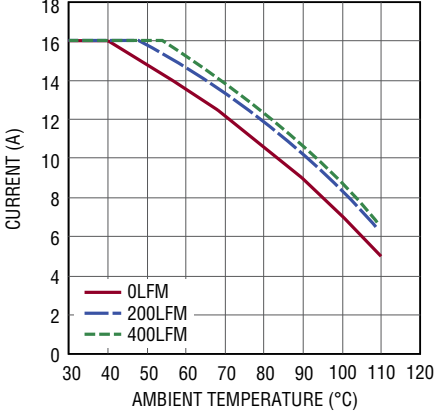
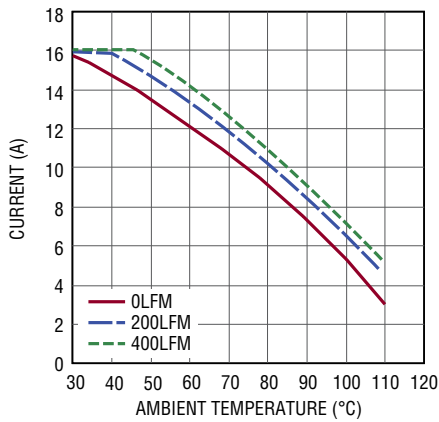

Figure 20. 5V_{IN} to 1.5V_{OUT} Derating Curve 4-Channel Paralleled, No Heat Sink

4641 F20

APPLICATIONS INFORMATION



**Figure 21. 12V_{IN} to 1.5V_{OUT}
Derating Curve 4-Channel
Paralleled, No Heat Sink**

4641 F21

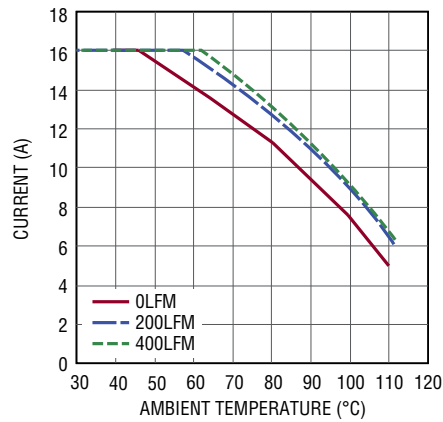

**Figure 22. 5V_{IN} to 1.5V_{OUT}
Derating Curve 4-Channel
Paralleled, BGA Heat Sink**

4641 F22

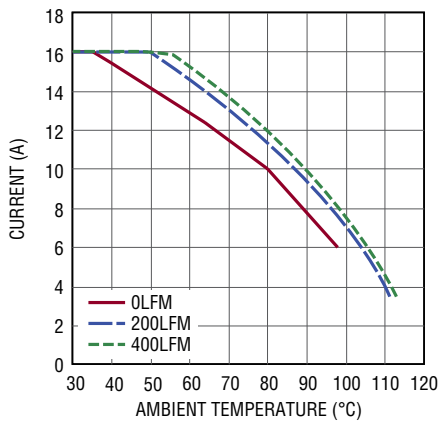

**Figure 23. 12V_{IN} to 1.5V_{OUT}
Derating Curve 4-Channel
Paralleled, BGA Heat Sink**

4641 F23

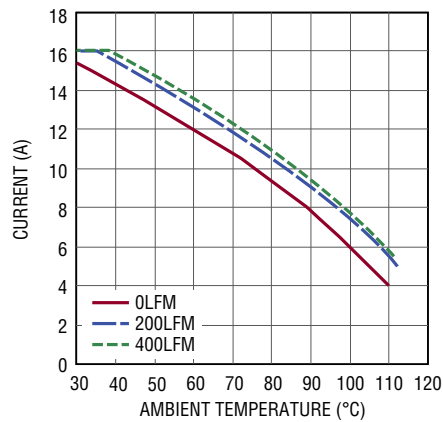

**Figure 24. 5V_{IN} to 3.3V_{OUT}
Derating Curve 4-Channel
Paralleled, No Heat Sink**

4641 F24

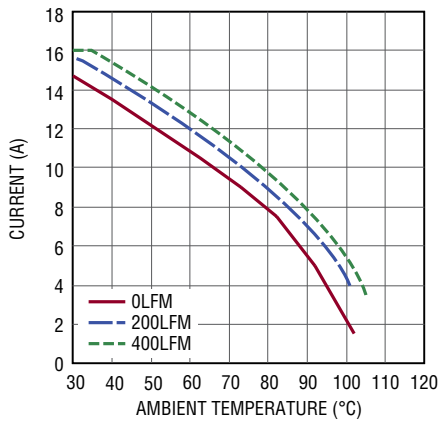

**Figure 25. 12V_{IN} to 3.3V_{OUT}
Derating Curve 4-Channel
Paralleled, No Heat Sink**

4641 F25

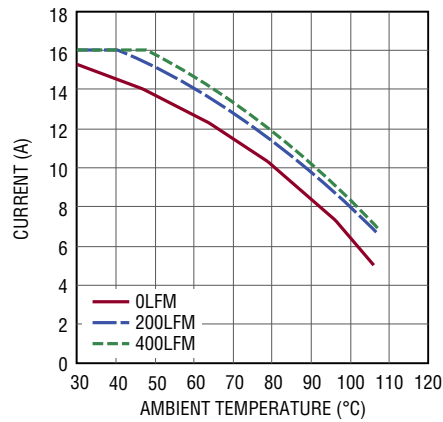

**Figure 26. 5V_{IN} to 3.3V_{OUT}
Derating Curve 4-Channel
Paralleled, BGA Heat Sink**

4641 F26

APPLICATIONS INFORMATION

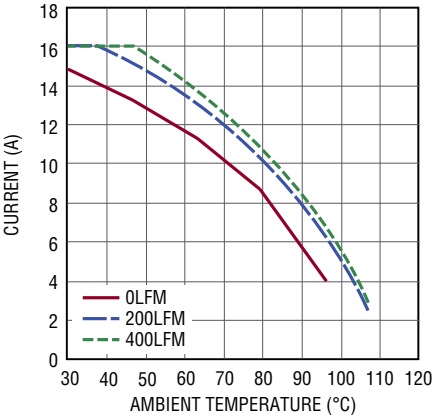

4641 F27

Figure 27. 12V_{IN} to 3.3V_{OUT} Derating Curve 4-Channel Paralleled, BGA Heat Sink

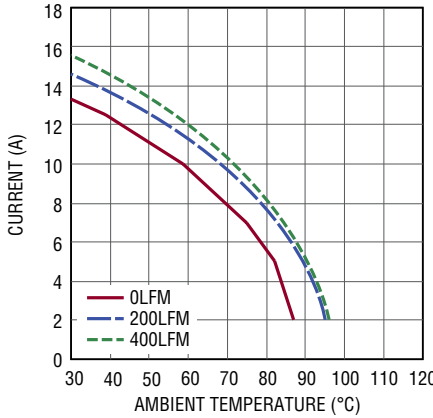

4641 F28

Figure 28. 12V_{IN} to 5V_{OUT} Derating Curve 4-Channel Paralleled, No Heat Sink

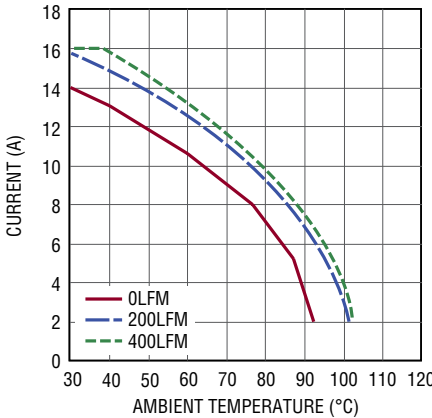

4641 F29

Figure 29. 12V_{IN} to 5V_{OUT} Derating Curve 4-Channel Paralleled, BGA Heat Sink

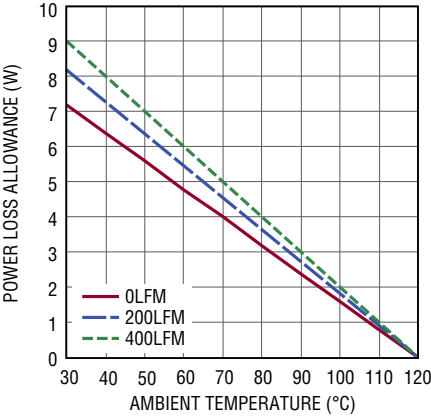

4641 F30

Figure 30. Power Loss Allowance vs. Ambient Temperature No Heat Sink

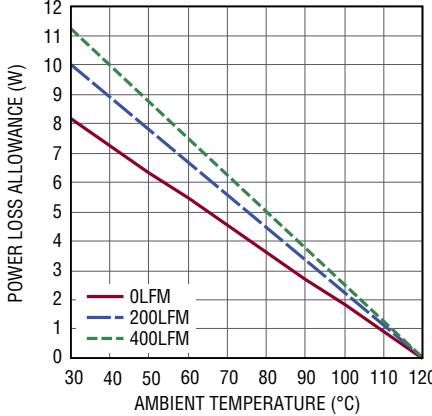

4641 F31

Figure 31. Power Loss Allowance vs. Ambient Temperature BGA Heat Sink

APPLICATIONS INFORMATION

Table 3. 1.0V Output

DERATING CURVE	V _{IN} (V)	POWER LOSS CURVE	AIR FLOW (LFM)	HEAT SINK	Θ _{JA} (°C/W)
Figures 16, 17	5, 12	Figure 9	0	None	12.5
Figures 16, 17	5, 12	Figure 9	200	None	11
Figures 16, 17	5, 12	Figure 9	400	None	10
Figures 18, 19	5, 12	Figure 9	0	BGA Heat Sink	11
Figures 18, 19	5, 12	Figure 9	200	BGA Heat Sink	9
Figures 18, 19	5, 12	Figure 9	400	BGA Heat Sink	8

Table 4. 1.5V Output

DERATING CURVE	V _{IN} (V)	POWER LOSS CURVE	AIR FLOW (LFM)	HEAT SINK	Θ _{JA} (°C/W)
Figures 20, 21	5, 12	Figure 11	0	None	12.5
Figures 20, 21	5, 12	Figure 11	200	None	11
Figures 20, 21	5, 12	Figure 11	400	None	10
Figures 22, 23	5, 12	Figure 11	0	BGA Heat Sink	11
Figures 22, 23	5, 12	Figure 11	200	BGA Heat Sink	9
Figures 22, 23	5, 12	Figure 11	400	BGA Heat Sink	8

Table 5. 3.3V Output

DERATING CURVE	V _{IN} (V)	POWER LOSS CURVE	AIR FLOW (LFM)	HEAT SINK	Θ _{JA} (°C/W)
Figures 24, 25	5, 12	Figure 14	0	None	12.5
Figures 24, 25	5, 12	Figure 14	200	None	11
Figures 24, 25	5, 12	Figure 14	400	None	10
Figures 26, 27	5, 12	Figure 14	0	BGA Heat Sink	11
Figures 26, 27	5, 12	Figure 14	200	BGA Heat Sink	9
Figures 26, 27	5, 12	Figure 14	400	BGA Heat Sink	8

Table 6. 5V Output

DERATING CURVE	V _{IN} (V)	POWER LOSS CURVE	AIR FLOW (LFM)	HEAT SINK	Θ _{JA} (°C/W)
Figures 26, 27	12	Figure 15	0	None	12.5
Figures 26, 27	12	Figure 15	200	None	11
Figures 26, 27	12	Figure 15	400	None	10
Figures 28, 29	12	Figure 15	0	BGA Heat Sink	11
Figures 28, 29	12	Figure 15	200	BGA Heat Sink	9
Figures 28, 29	12	Figure 15	400	BGA Heat Sink	8

APPLICATIONS INFORMATION

Table 7

C _{IN}	PART NUMBER	VALUE	C _{OUT1}	PART NUMBER	VALUE	C _{OUT2}	PART NUMBER	VALUE
Murata	GRM21BR61C106KE15L	10 μ F, 16V, 0805, X5R	Murata	GRM21BR60J476ME15	47 μ F, 6.3V, 0805, X5R	Sanyo	4TPE100MZB	4V 100 μ F
Taiyo Yuden	EMK212BJ106KG-T	10 μ F, 16V, 0805, X5R	Taiyo Yuden	JMK212BJ476MG-T	47 μ F, 6.3V, 0805, X5R			
Murata	GRM31CR61C226ME15L	22 μ F, 16V, 1206, X5R						
Taiyo Yuden	EMK316BJ226ML-T	22 μ F, 16V, 1206, X5R						

V _{OUT} (V)	C _{IN} (CERAMIC) (μ F)	C _{IN} (BULK)	C _{OUT1} (CERAMIC) (μ F)	C _{OUT2} (BULK) (μ F)	C _{FF} (pF)	V _{IN} (V)	DROOP (mv)	P-P DERIVATION (mV)	RECOVERY TIME (μ s)	LOAD STEP (A)	LOAD STEP SLEW RATE (A/ μ s)	R _{FB} (k Ω)
1	10		47			5,12	5	72	40	1	1	90.9
1	10			100 μ F	10	5,12	5	60	40	1	1	90.9
1	10		47			5,12	5	127	40	2	1	90.9
1	10			100 μ F	10	5,12	5	90	40	2	1	90.9
1.2	10		47			5,12	5	76	40	1	1	60.4
1.2	10			100 μ F	10	5,12	5	65	40	1	1	60.4
1.2	10		47			5,12	5	145	40	2	1	60.4
1.2	10			100 μ F	10	5,12	5	103	40	2	1	60.4
1.5	10		47			5,12	5	80	40	1	1	40.2
1.5	10			100 μ F	10	5,12	5	70	40	1	1	40.2
1.5	10		47			5,12	5	161	40	2	1	40.2
1.5	10			100 μ F	10	5,12	5	115	40	2	1	40.2
1.8	10		47			5,12	5	95	40	1	1	30.1
1.8	10			100 μ F	10	5,12	5	80	40	1	1	30.1
1.8	10		47			5,12	5	177	40	2	1	30.1
1.8	10			100 μ F	10	5,12	5	128	40	2	1	30.1
2.5	10		47			5,12	5	125	40	1	1	19.1
2.5	10			100 μ F	10	5,12	5	100	50	1	1	19.1
2.5	10		47			5,12	5	225	40	2	1	19.1
2.5	10			100 μ F	10	5,12	5	161	50	2	1	19.1
3.3	10		47			5,12	5	155	40	1	1	13.3
3.3	10			100 μ F	10	5,12	5	122	60	1	1	13.3
3.3	10		47			5,12	5	285	40	2	1	13.3
3.3	10			100 μ F	10	5,12	5	198	60	2	1	13.3
5	10		47		10	5,12	5	220	40	1	1	8.25
5	10			100 μ F	10	5,12	5	420	40	2	1	8.25

APPLICATIONS INFORMATION

Layout Checklist/Example

The high integration of LTM4644 makes the PCB board layout very simple and easy. However, to optimize its electrical and thermal performance, some layout considerations are still necessary.

- Use large PCB copper areas for high current paths, including V_{IN1} to V_{IN4} , GND, V_{OUT1} to V_{OUT4} . It helps to minimize the PCB conduction loss and thermal stress.
- Place high frequency ceramic input and output capacitors next to the V_{IN} , GND and V_{OUT} pins to minimize high frequency noise.
- Place a dedicated power ground layer underneath the unit.
- To minimize the via conduction loss and reduce module thermal stress, use multiple vias for interconnection between top layer and other power layers.
- Do not put via directly on the pad, unless they are capped or plated over.
- Use a separated SGND ground copper area for components connected to signal pins. Connect the SGND to GND underneath the unit.
- For parallel modules, tie the V_{OUT} , V_{FB} , and COMP pins together. Use an internal layer to closely connect these pins together. The TRACK/SS pin can be tied a common capacitor for regulator soft-start.
- Bring out test points on the signal pins for monitoring.

Figure 32 gives a good example of the recommended layout.

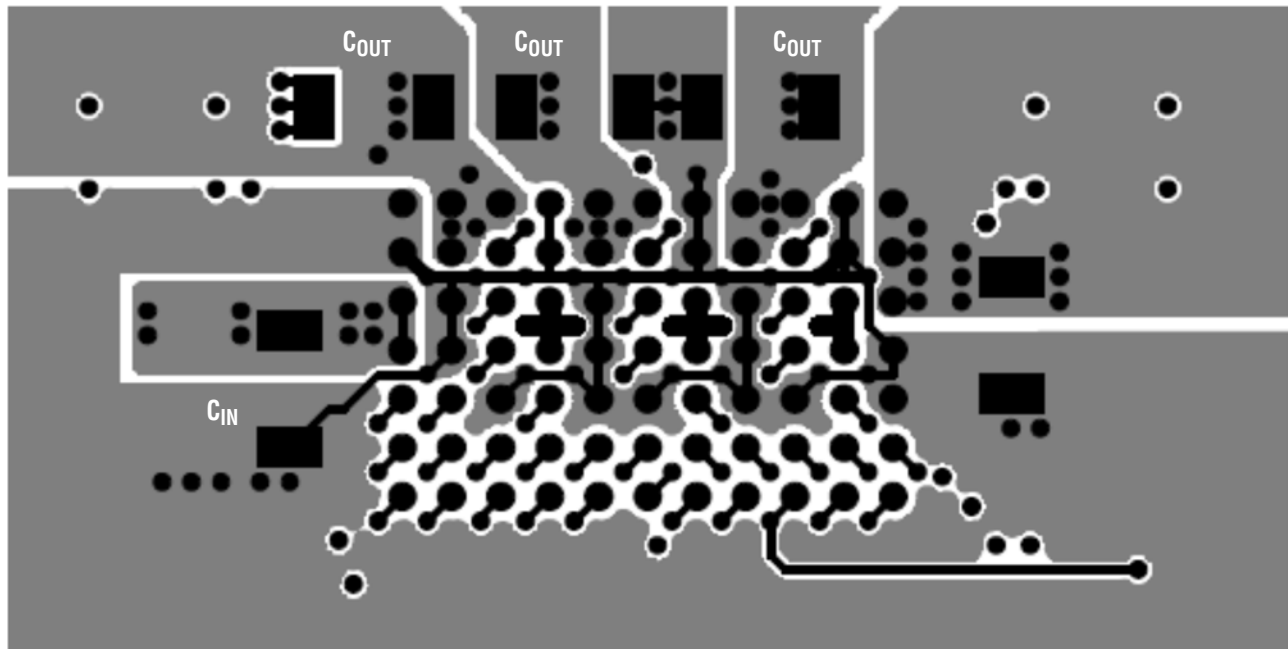

Figure 32. Recommended PCB Layout

TYPICAL APPLICATIONS

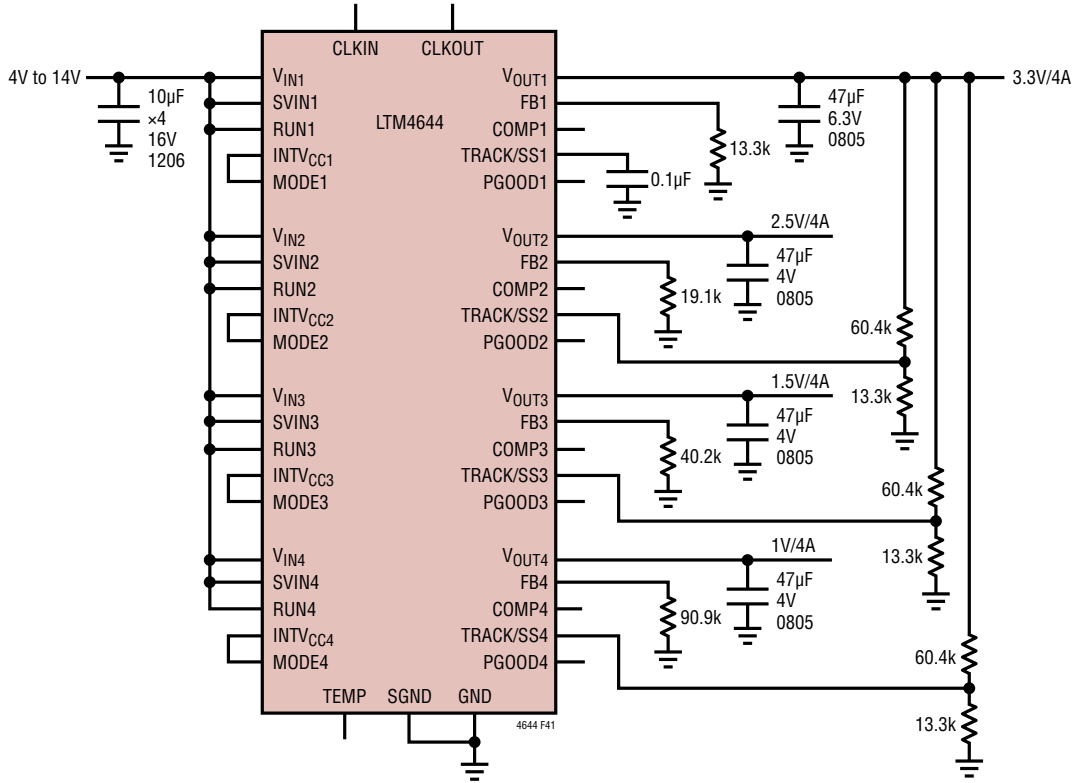

Figure 33. 4V to 14V Input, Quad 1.2V, 1.5V, 2.5V and 3.3V Output with Tracking

TYPICAL APPLICATIONS

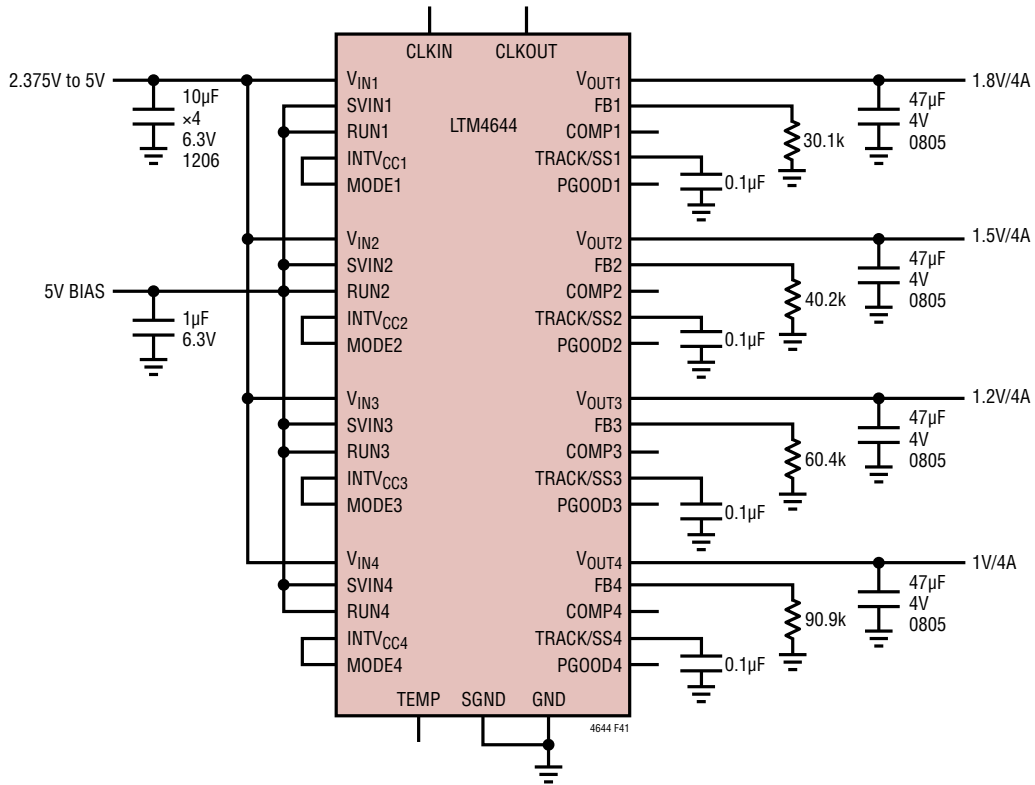

Figure 34. 2.375V to 5V Input, Quad 1V, 1.2V, 1.5V, 1.8V Output

TYPICAL APPLICATIONS

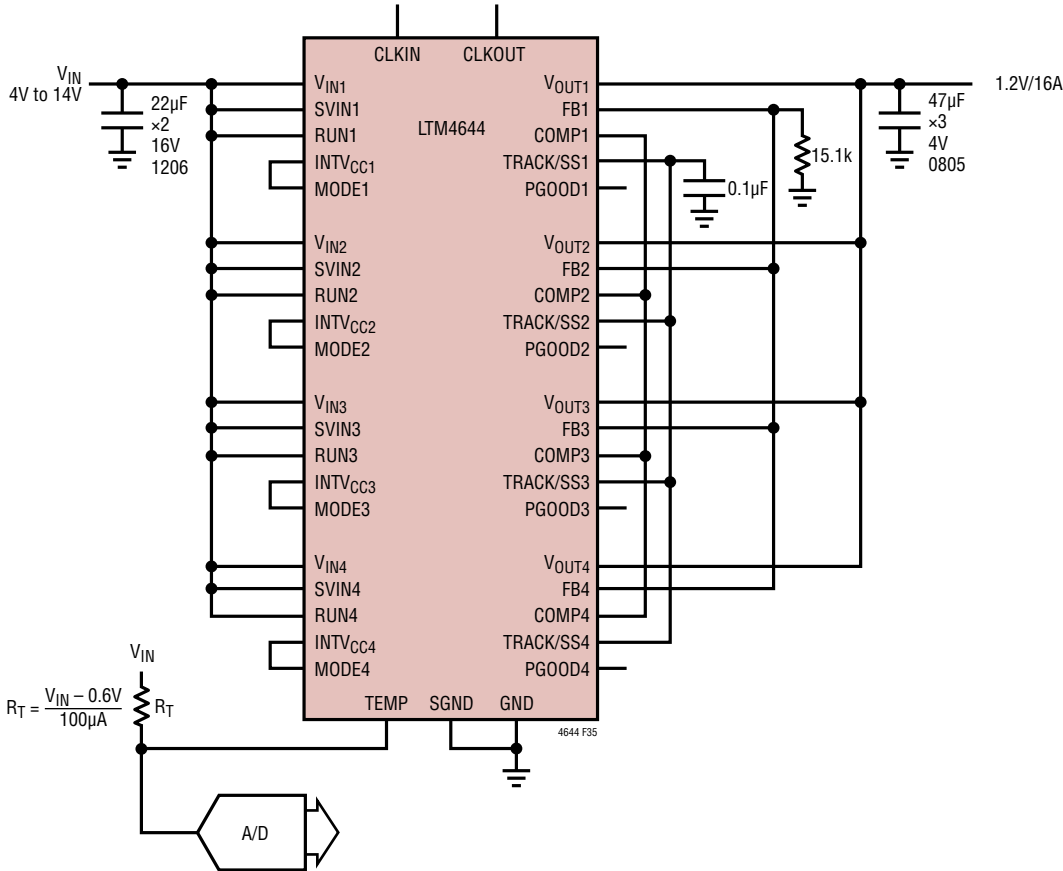

Figure 35. 4V to 14V Input, 4-Phase, 1.2V at 16A Design with Temperature Monitoring

TYPICAL APPLICATIONS

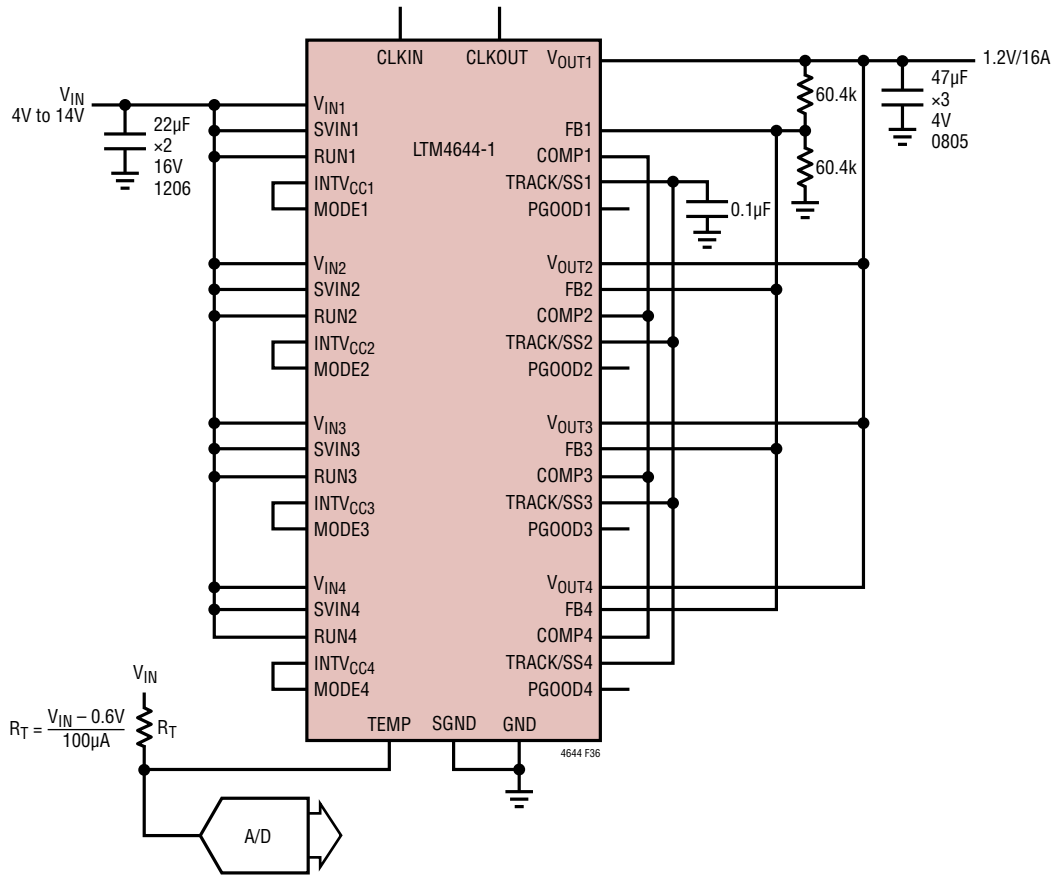

Figure 36. 4V to 14V Input, 4-Phase, 1.2V at 16A Design with Temperature Monitoring

TYPICAL APPLICATIONS

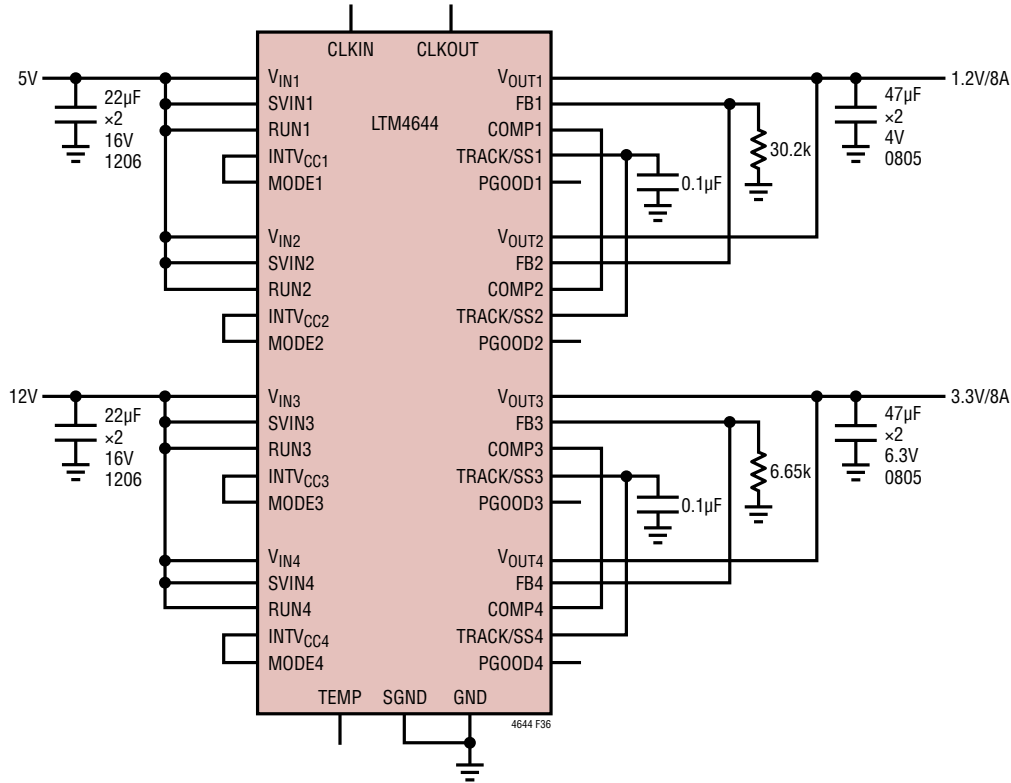

Figure 37. 12V and 5V Two Separate Input Rails, 1.2V at 8A and 3.3V at 8A Output

TYPICAL APPLICATIONS

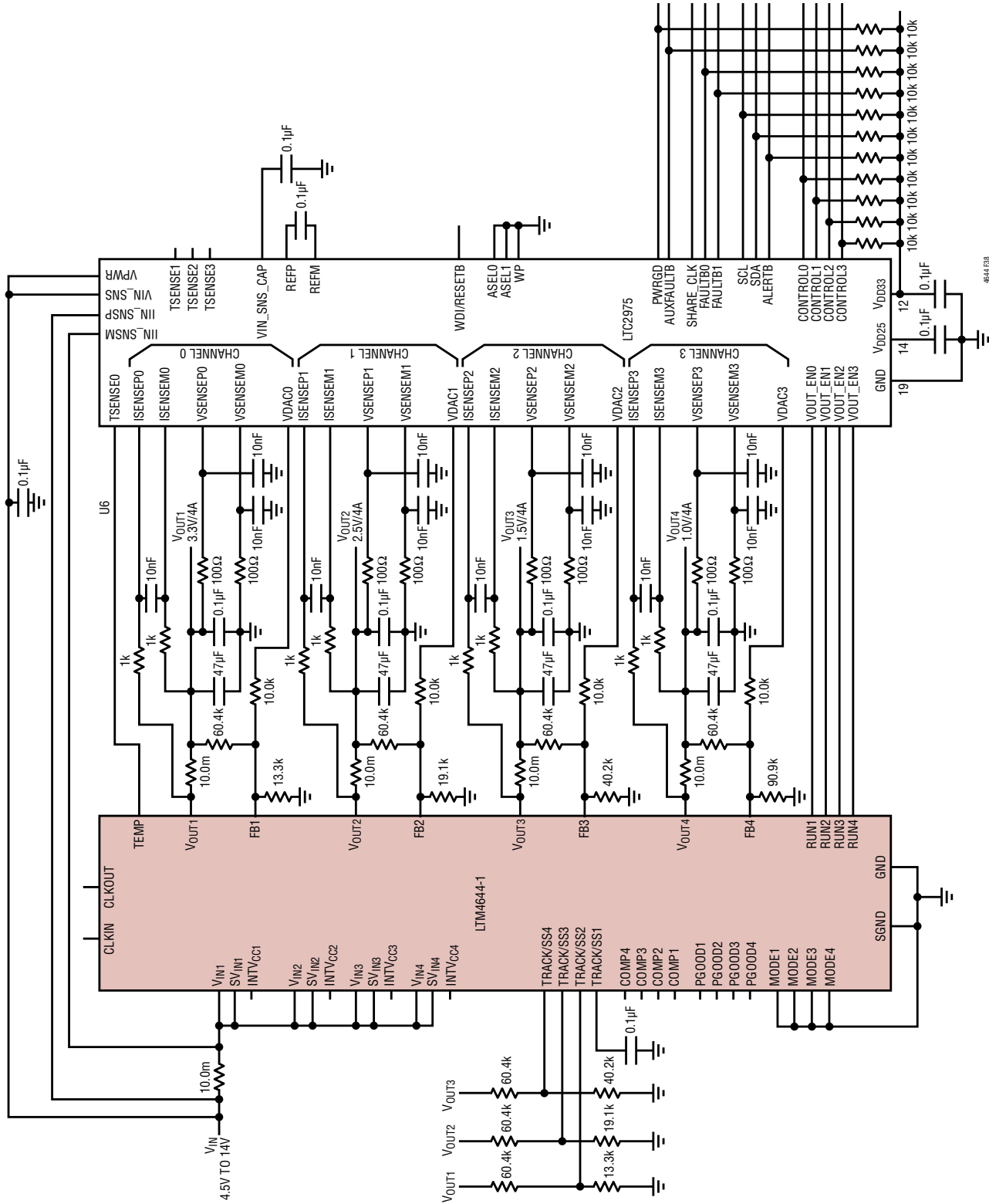

Figure 38. LTM4644-1 Together with LTC2975, 4.5V to 14V Input, 3.3V, 2.5V, 1.5V, 1V Output at 4A Each with Input and Output Voltage, Current and Temperature Telemetry.

PACKAGE DESCRIPTION



PACKAGE ROW AND COLUMN LABELING MAY VARY
AMONG μ Module PRODUCTS. REVIEW EACH PACKAGE
LAYOUT CAREFULLY.

LTM4644/LTM4644-1 Component BGA Pinout

PIN	NAME	PIN	NAME	PIN	NAME	PIN	NAME	PIN	NAME	PIN	NAME
A1	V _{OUT1}	B1	GND	C1	V _{OUT2}	D1	V _{OUT2}	E1	GND	F1	V _{OUT3}
A2	V _{OUT1}	B2	GND	C2	PGOOD2	D2	V _{OUT2}	E2	GND	F2	PGOOD3
A3	V _{OUT1}	B3	V _{IN1}	C3	PGOOD1	D3	GND	E3	V _{IN2}	F3	TEMP
A4	GND	B4	V _{IN1}	C4	INTV _{CC1}	D4	GND	E4	V _{IN2}	F4	INTV _{CC2}
A5	GND	B5	SV _{IN1}	C5	GND	D5	GND	E5	SV _{IN2}	F5	GND
A6	TRACK/SS1	B6	MODE1	C6	RUN1	D6	TRACK/SS2	E6	MODE2	F6	RUN2
A7	FB1	B7	COMP1	C7	CLKIN	D7	FB2	E7	COMP2	F7	SGND

PIN	NAME	PIN	NAME	PIN	NAME	PIN	NAME	PIN	NAME		
G1	V _{OUT3}	H1	GND	J1	V _{OUT4}	K1	V _{OUT4}	L1	GND		
G2	V _{OUT3}	H2	GND	J2	PGOOD4	K2	V _{OUT4}	L2	GND		
G3	GND	H3	V _{IN3}	J3	CLKOUT	K3	GND	L3	V _{IN4}		
G4	GND	H4	V _{IN3}	J4	INTV _{CC3}	K4	GND	L4	V _{IN4}		
G5	GND	H5	SV _{IN3}	J5	GND	K5	INTV _{CC4}	L5	SV _{IN4}		
G6	TRACK/SS3	H6	MODE3	J6	RUN3	K6	TRACK/SS4	L6	MODE4		
G7	FB3	H7	COMP3	J7	FB4	K7	RUN4	L7	COMP4		

PACKAGE DESCRIPTION

BGA Package 77-Lead (9mm x 15mm x 5.01mm) (Reference LTC DWG # 05-08-1900 Rev D)

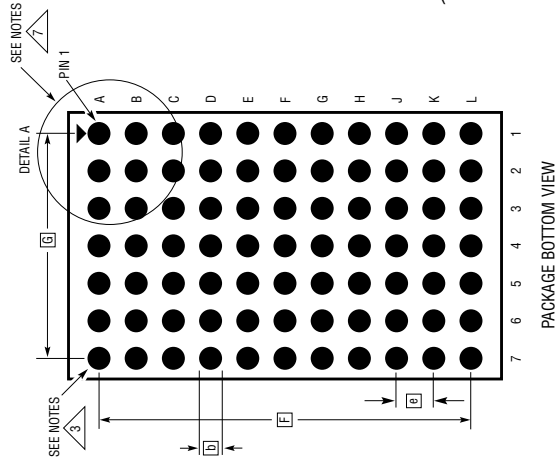

- NOTES:**
1. DIMENSIONING AND TOLERANCING PER ASME Y14.5M-1994
 2. ALL DIMENSIONS ARE IN MILLIMETERS
 3. BALL DESIGNATION PER JEDEC MS-028 AND JEP95
 4. DETAILS OF PIN #1 IDENTIFIER ARE OPTIONAL BUT MUST BE LOCATED WITHIN THE ZONE INDICATED. THE PIN #1 IDENTIFIER MAY BE EITHER A MOLD OR MARKED FEATURE
 5. PRIMARY DATUM -Z- IS SEATING PLANE
 6. SOLDER BALL COMPOSITION IS 96.5% Sn/3.0% Ag/0.5% Cu
 7. PACKAGE ROW AND COLUMN LABELING MAY VARY AMONG μ Module PRODUCTS. REVIEW EACH PACKAGE LAYOUT CAREFULLY

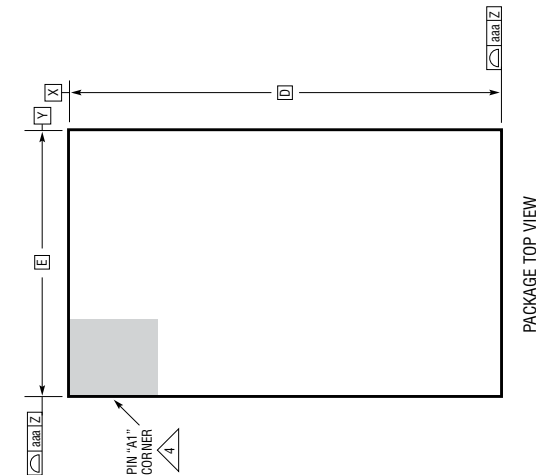
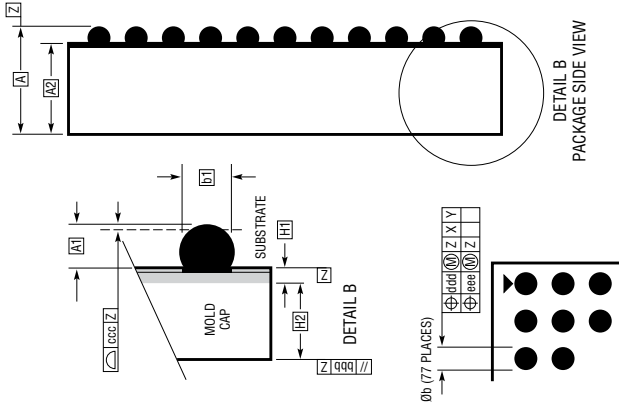
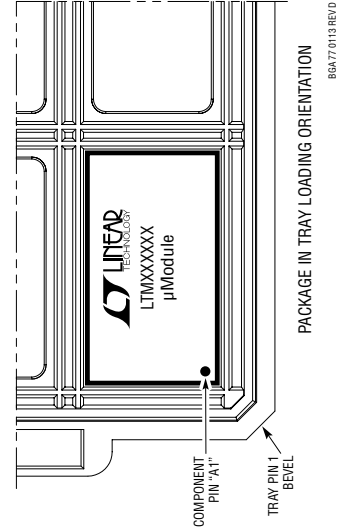

SYMBOL	DIMENSIONS		NOTES
	MIN	MAX	
A	4.81	5.21	
A1	0.50	0.70	
A2	4.31	4.51	
b	0.60	0.75	
b1	0.60	0.63	
D	15.00		
E	9.00		
e	1.27		
F	12.70		
G	7.62		
H1	0.36	0.41	0.46
H2	3.95	4.00	4.05
aaa			0.15
bbb			0.10
ccc			0.20
ddd			0.30
eee			0.15
TOTAL NUMBER OF BALLS: 77			

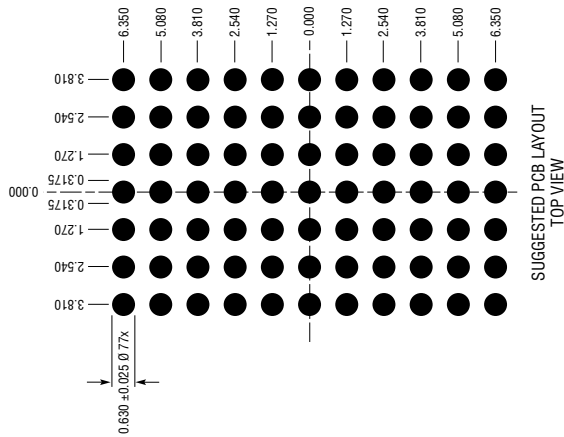

REVISION HISTORY

REV	DATE	DESCRIPTION	PAGE NUMBER
A	01/14	Add SnPb BGA package option	1, 2
B	06/14	Add Tech Clip video link	1
		Update Order Information	2
		Update Run Threshold	3
		Update Figure 5	13
		Update Soft-Start and Output Voltage Tracking Section	14
C	05/16	Added MP-grade (-55°C to 125°C)	2
D	12/16	Added LTM4644-1	1, 2, 4, 9, 10, 33
		Added Comparison Table between LTM4644 and LTM4644-1	1
		Added Output Voltage Programing (LTM4644-1)	10
		Added Figure 36	30
		Added Figure 38	32
E	01/18	Changed I _{OUTPK} (MIN) from 5A to 6A	3
F	02/19	Increased Storage Temperature Range to -65°C to 150°C	2

PACKAGE PHOTO

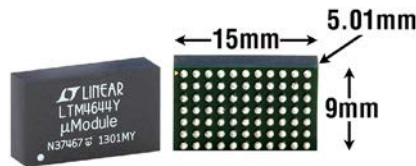

DESIGN RESOURCES

SUBJECT	DESCRIPTION
μModule Design and Manufacturing Resources	<p>Design:</p> <ul style="list-style-type: none"> • Selector Guides • Demo Boards and Gerber Files • Free Simulation Tools <p>Manufacturing:</p> <ul style="list-style-type: none"> • Quick Start Guide • PCB Design, Assembly and Manufacturing Guidelines • Package and Board Level Reliability
μModule Regulator Products Search	<ol style="list-style-type: none"> 1. Sort table of products by parameters and download the result as a spread sheet. 2. Search using the Quick Power Search parametric table. <div style="border: 1px solid #ccc; padding: 5px; margin: 10px 0;"> <p>Quick Power Search</p> <p>Input V_{in} (Min) <input type="text"/> V V_{in} (Max) <input type="text"/> V</p> <p>Output V_{out} <input type="text"/> V I_{out} <input type="text"/> A</p> <p style="text-align: right;"><input type="button" value="Search"/></p> </div>
TechClip Videos	Quick videos detailing how to bench test electrical and thermal performance of μModule products.
Digital Power System Management	Analog Devices' family of digital power supply management ICs are highly integrated solutions that offer essential functions, including power supply monitoring, supervision, margining and sequencing, and feature EEPROM for storing user configurations and fault logging.

RELATED PARTS

PART NUMBER	DESCRIPTION	COMMENTS
LTM4622	Ultrathin, Dual 2.5A Step-Down μModule Regulator	$3.6V \leq V_{IN} \leq 20V$. $0.6V \leq V_{OUT} \leq 5.5V$. 6.25mm x 6.25mm x 1.82mm LGA, 2.42mm BGA.
LTM4622A	High Vout, Ultrathin, Dual 2.5A Step-Down μModule Regulator	$3.6V \leq V_{IN} \leq 20V$. $1.5V \leq V_{OUT} \leq 12V$. 6.25mm x 6.25mm x 1.82mm LGA, 2.42mm BGA.
LTM4623	Ultrathin, Single 3A μModule Regulator	$4V \leq V_{IN} \leq 20V$. $0.6V \leq V_{OUT} \leq 5.5V$. 6.25mm x 6.25mm x 1.82mm LGA, 2.42mm BGA.
LTM4624	Single 4A μModule Regulator	$4V \leq V_{IN} \leq 14V$. $0.6V \leq V_{OUT} \leq 5.5V$. 6.25mm x 6.25mm x 5.01mm BGA.
LTM4625	Single 5A μModule Regulator	$4V \leq V_{IN} \leq 20V$. $0.6V \leq V_{OUT} \leq 5.5V$. 6.25mm x 6.25mm x 5.01mm BGA.
LTM4626	Single 12A μModule Regulator	$3.1V \leq V_{IN} \leq 20V$. $0.6V \leq V_{OUT} \leq 5.5V$. 6.25mm x 6.25mm x 3.87mm BGA.
LTM4638	Single 15A μModule Regulator	$3.1V \leq V_{IN} \leq 20V$. $0.6V \leq V_{OUT} \leq 5.5V$. 6.25mm x 6.25mm x 5.02mm BGA.
LTM4643	Ultrathin, Quad 3A, Step-Down μModule Regulator. Pin Compatible with the LTM4644.	$4V \leq V_{IN} \leq 20V$, $0.6V \leq V_{OUT} \leq 3.3V$, 9mm x 15mm x 1.82mm LGA, 2.42mm BGA.
LTM4646	Dual 10A μModule Regulator	$4.5V \leq V_{IN} \leq 20V$. $0.6V \leq V_{OUT} \leq 5.5V$. 11.25mm x 15mm x 5.01mm BGA
LTC2978	Octal Digital Power Supply Manager with EEPROM	I ² C/PMBus Interface, Configuration EEPROM, Fault Logging, 16-Bit ADC with $\pm 0.25\%$ TUE, 3.3V to 15V Operation
LTC2974	Quad Digital Power Supply Manager with EEPROM	I ² C/PMBus Interface, Configuration EEPROM, Fault Logging, Per Channel Voltage, Current and Temperature Measurements



Компания «ЭлектроПласт» предлагает заключение долгосрочных отношений при поставках импортных электронных компонентов на взаимовыгодных условиях!

Наши преимущества:

- Оперативные поставки широкого спектра электронных компонентов отечественного и импортного производства напрямую от производителей и с крупнейших мировых складов;
- Поставка более 17-ти миллионов наименований электронных компонентов;
- Поставка сложных, дефицитных, либо снятых с производства позиций;
- Оперативные сроки поставки под заказ (от 5 рабочих дней);
- Экспресс доставка в любую точку России;
- Техническая поддержка проекта, помощь в подборе аналогов, поставка прототипов;
- Система менеджмента качества сертифицирована по Международному стандарту ISO 9001;
- Лицензия ФСБ на осуществление работ с использованием сведений, составляющих государственную тайну;
- Поставка специализированных компонентов (Xilinx, Altera, Analog Devices, Intersil, Interpoint, Microsemi, Aeroflex, Peregrine, Syfer, Eurofarad, Texas Instrument, Miteq, Cobham, E2V, MA-COM, Hittite, Mini-Circuits, General Dynamics и др.);

Помимо этого, одним из направлений компании «ЭлектроПласт» является направление «Источники питания». Мы предлагаем Вам помощь Конструкторского отдела:

- Подбор оптимального решения, техническое обоснование при выборе компонента;
- Подбор аналогов;
- Консультации по применению компонента;
- Поставка образцов и прототипов;
- Техническая поддержка проекта;
- Защита от снятия компонента с производства.



Как с нами связаться

Телефон: 8 (812) 309 58 32 (многоканальный)

Факс: 8 (812) 320-02-42

Электронная почта: org@eplast1.ru

Адрес: 198099, г. Санкт-Петербург, ул. Калинина, дом 2, корпус 4, литера А.