

Ultra Small Temperature Switches with Pin Selectable Hysteresis

Features

- 5-Pin SOT-23A
- Factory-programmed Thresholds from -45°C to +125°C in 10°C Increments
- Pin Selectable +2°C or +10°C Hysteresis
- ±0.5°C (Typ) Threshold Accuracy Over Full Temperature Range
- No External Components Required
- 17 µA Supply Current (Typ)

Applications

- Thermal Management in PCs and Servers
- Over-temperature Fail-safe Circuits
- Simple Fan Controller
- Temperature Alarms
- Projectors/Printers
- Notebook Computers
- Network Boxes

Package Types



General Description

The TC6501/2/3/4 are SOT-23 temperature switches that require no external components and are available with factory-programmed temperature thresholds. A choice of factory-trimmed temperature trip points are also available. Pin-selectable hysteresis of +2°C or +10°C allows flexibility to the design of the application. These parts typically consume only 17 µA of current and operate over the entire -55°C to +135°C temperature range, while offering accuracies of ±0.5°C (typ).

The TC6501 and TC6503 have an open-drain, active-low output, which targets microcontroller reset control. The TC6502 and TC6504 have a CMOS, active-high output designed to drive the logic level MOSFET that turns on a fan or heater element.

The TC6501/TC6502 are designed for hot temperature monitoring (+35°C to +125°C). These devices assert a logic signal when the temperature goes above the threshold. The TC6503/TC6504 are optimized for cold temperature monitoring (-45°C to +15°C) and assert a logic signal when the temperature goes below the threshold.

The TC6501/2/3/4 are offered with five standard temperature thresholds. Available in 5-Pin SOT-23A packages, these parts are ideal for applications requiring high integration, small size, low power and low installed cost.

Functional Block Diagram



TC6501/2/3/4

1.0 ELECTRICAL CHARACTERISTICS

Absolute Maximum Ratings*

Supply Voltage (V_{CC})	-0.3V to +7V
Input Current (All Pins)	20 mA
Output Current (All Pins)	20 mA
Operating Temperature Range	- 55°C to +135°C
Storage Temperature Range	- 65°C to +165°C
$T_{\overline{O}}VER$ (TC6501)	-0.3V to +7V
$T_{O}VER$ (TC6502)	-0.3V to ($V_{CC} + 0.3V$)
$T_{\underline{O}}NDER$ (TC6503)	-0.3V to 7V
$T_{\underline{O}}NDER$ (TC6504)	-0.3V to ($V_{CC} + 0.3V$)
All Other Pins	-0.3V to ($V_{CC} + 0.3V$)
Maximum Junction Temperature, T_J	150°C
Power Dissipation ($T_A = +70^\circ C$): (Derate 7.1 mW/°C Above +70°C)	570 mW

* **Notice:** Stresses above those listed under “Maximum Ratings” may cause permanent damage to the device. This is a stress rating only and functional operation of the device at these or any other conditions above those indicated in the operational sections of the specifications is not implied. Exposure to maximum rating conditions for extended periods may affect device reliability.

ELECTRICAL SPECIFICATIONS

Electrical Characteristics: Unless otherwise noted, $V_{CC} = +2.7V$ to $+5.5V$, $R_{PULL-UP} = 100\ k\Omega$ (TC6501/TC6503 only), 100 pF decoupling capacitor from V_{CC} to GND, $T_{AMB} = -55^\circ C$ to $+135^\circ C$. Typical values are at $T_A = +25^\circ C$.						
Parameter	Symbol	Min	Typ	Max	Unit	Test Conditions
Supply Voltage Range	V_{CC}	2.7	—	5.5	V	
Supply Current	I_{CC}	—	17	40	μA	
HYST Input Threshold	V_{IH}	$0.8 \times V_{CC}$	—	—	V	
HYST Input Threshold	V_{IL}	—	—	$0.2 \times V_{CC}$	V	
Temperature Threshold Accuracy (Note 1)	ΔT_{TH}	-6	± 0.5	6	$^\circ C$	-45°C to -25°C
		-4	± 0.5	4	$^\circ C$	-15°C to +15°C
		-4	± 0.5	4	$^\circ C$	+35°C to +65°C
		-6	± 0.5	6	$^\circ C$	+75°C to +125°C
Temperature Threshold Hysteresis	T_{HYST}	—	2.0	—	$^\circ C$	$HYST = GND$
		—	10	—	$^\circ C$	$HYST = V_{CC}$
Output Voltage High	V_{OH}	$0.8 \times V_{CC}$	—	—	V	$I_{SOURCE} = 500\ \mu A$, $V_{CC} > 2.7V$ (TC6502/TC6504 Only)
		$V_{CC} - 1.5$	—	—	V	$I_{SOURCE} = 800\ \mu A$, $V_{CC} > 4.5V$ (TC6502/TC6504 Only)
Output Voltage Low	V_{OL}	—	—	0.3	V	$I_{SINK} = 1.2\ mA$, $V_{CC} > 2.7V$
		—	—	0.4	V	$I_{SINK} = 3.2\ mA$, $V_{CC} > 4.5V$
Open-Drain Output Leakage Current		—	10	—	nA	$V_{CC} = 2.7V$, $T_{\underline{O}}NDER = 5.5V$ (TC6503); $T_{\overline{O}}VER = 5.5V$ (TC6501)

Note 1: The TC6501/2/3/4 are available with internal, factory-programmed temperature trip thresholds from -45°C to +125°C, in +10°C increments.

2.0 TYPICAL PERFORMANCE CURVES

Note: The graphs and tables provided following this note are a statistical summary based on a limited number of samples and are provided for informational purposes only. The performance characteristics listed herein are not tested or guaranteed. In some graphs or tables, the data presented may be outside the specified operating range (e.g., outside specified power supply range) and therefore outside the warranted range.

Note: Unless otherwise noted, $V_{CC} = 5.0V$, $R_{PULL-UP} = 100\text{ k}\Omega$ (TC6501/TC6503 only), 100 pF decoupling capacitor from V_{CC} to GND, $T_{AMB} = +25^\circ\text{C}$.



FIGURE 2-1: Trip Threshold Accuracy.



FIGURE 2-4: Supply Current vs. Temperature.

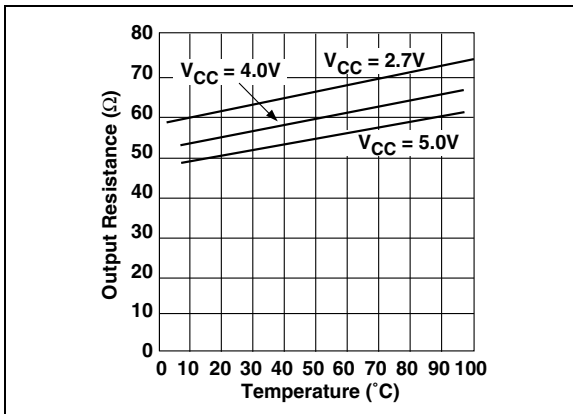

FIGURE 2-2: Output Sink Resistance vs. Temperature.

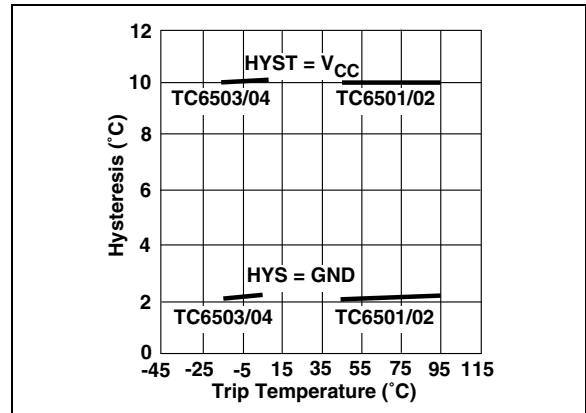

FIGURE 2-5: Hysteresis vs. Trip Temperature.



FIGURE 2-3: Thermal Step Response in Perfluorinated Fluid (SOT-23).



FIGURE 2-6: Thermal Step Response in Still Air (SOT-23).

TC6501/2/3/4

Note: Unless otherwise noted, $V_{CC} = 5.0V$, $R_{PULL-UP} = 100\text{ k}\Omega$ (TC6501/TC6503 only), 100 pF decoupling capacitor from V_{CC} to GND, $T_{AMB} = +25^{\circ}\text{C}$.



FIGURE 2-7: Output Source Resistance vs. Temperature (TC6502).

3.0 PIN DESCRIPTIONS

The descriptions of the pins are listed in Table 3-1.

TABLE 3-1: PIN FUNCTION TABLE

TC6501	TC6502	TC6503	TC6504	Symbol	Description
1, 2	1, 2	1, 2	1, 2	GND	Ground
3	3	3	3	HYST	Hysteresis Input
4	4	4	4	V _{CC}	Supply Input (+2.7V to +5.5V)
5	—	—	—	T _{OVER}	Open-Drain, Active-Low Output
—	5	—	—	T _{OVER}	Push/Pull Active-High Output
—	—	5	—	T _{UNDER}	Open-Drain, Active-Low Output
—	—	—	5	T _{UNDER}	Push/Pull Active-High Output

3.1 Ground

Connect the device ground pins directly to the PCB ground and minimize the length of the connection. The thermal resistance to the die is at a minimum at Pin 2.

3.2 Hysteresis Input (HYST)

Either 2°C (GND) or 10°C (V_{CC}) of hysteresis is selected by connecting HYST to GND or V_{CC}.

3.3 Supply Input (V_{CC})

A 100 pF or greater decoupling capacitor from V_{CC} to GND is recommended.

3.4 Open-Drain, Active-Low Output (TC6501) (T_{OVER})

The voltage at the T_{OVER} pin is equal to a logic-low level if the sensor detects a temperature that is greater than the factory-programmed threshold temperature. Because this is an open-drain output, an external pull-up resistor is required (a 100 kΩ pull-up resistor is recommended). The voltage on this pin can be higher than V_{CC}, though the voltage must not exceed the absolute maximum input voltage of 7.0V.

3.5 Push/Pull Active-High Output (TC6502) (T_{OVER})

The voltage at T_{OVER} is equal to a logic-high level if the sensor detects a temperature greater than the factory-programmed threshold temperature.

3.6 Open-Drain, Active-Low Output (TC6503) (T_{UNDER})

The voltage at the T_{UNDER} pin is equal to a logic-low level if the sensor detects a temperature that is less than the factory-programmed threshold temperature. Because this is an open-drain output, an external pull-up resistor is required (a 100 kΩ pull-up resistor is recommended). The voltage on this pin can be higher than V_{CC}, though the voltage must not exceed the absolute maximum input voltage of 7.0V.

3.7 Push/Pull Active-High Output (TC6504) (T_{UNDER})

The voltage at T_{UNDER} is equal to a logic-high level if the sensor detects a temperature less than the factory-programmed threshold temperature.

TC6501/2/3/4

4.0 DETAILED DESCRIPTION

The TC6501/2/3/4 integrate a temperature sensor with a factory-programmed threshold switch (see Functional Block Diagrams in Figure 5-4 through Figure 5-7). A logic signal is asserted when the die temperature crosses the factory-programmed threshold. An external hysteresis input pin allows the user to select either 2°C or 10°C hysteresis to give further flexibility to the design of the application. The TC6501 and TC6502 are intended for a temperature range of 35°C to 125°C in 10°C increments. The TC6501 has an open-drain output, while the TC6502 has a push-pull output stage.

The TC6503 and TC6504 are intended for a cold temperature range of -45°C to +15°C in 10°C increments. The TC6503 has an open-drain output, while the TC6504 has a push/pull output stage. The TC6501 and TC6503 are intended for applications with a microcontroller reset input. The TC6502 and TC6504 are intended for applications where a fan or heater element is turned on.

Please contact Microchip Technology for the availability of a particular temperature threshold not included in Table 4-1.

4.1 Hysteresis Input

To prevent the output from “chattering” at or near the trip point temperature, a selectable HYST input pin is provided. Hysteresis can be externally selected at 2°C (HYST = GND) or 10°C (HYST = V_{CC}) by means of the CMOS compatible HYST input pin. Do not let the HYST pin float, as this could cause an increase in supply current. The hysteresis does not depend on the part’s programmed trip threshold.

TABLE 4-1: FACTORY-PROGRAMMED THRESHOLD RANGE

Part Number	Threshold (T _{TH}) Range
TC6501	+35°C < T _{TH} < +125°C
TC6502	+35°C < T _{TH} < +125°C
TC6503	-45°C < T _{TH} < +15°C
TC6504	-45°C < T _{TH} < +15°C

4.2 Thermal Considerations

With a 17 μA typical supply current, the TC6501/2/3/4 dissipates very little power. Thus, the die temperature is basically the same as the package temperature. To minimize the error in temperature readings, the load current should be limited to a few milliamps. For example, the typical thermal resistance of a 5-Pin SOT-23A package is 140°C/W. If, for instance, the TC6501 had to sink 1 mA, and the output voltage is ensured to be less than 0.3V, an additional 0.3 mW of power is dissipated within the temperature sensor. This corresponds to a 0.042°C rise in die temperature.

Temperature-monitoring accuracy depends on the thermal resistance between the device being monitored and the temperature switch die. Heat flows primarily through the leads onto the die. Pin 2 provides the lowest thermal resistance to the die. To achieve the best temperature-monitoring results, the TC6501/2/3/4 should be placed closest to the device being monitored. Additionally, a short and wide copper trace from pin 2 to the device should be used. In some cases, the 5-Pin SOT-23A package can be placed directly under the socketed microcontroller for improved thermal contact.

5.0 APPLICATIONS

The TC6501 and TC6503 have open-drain outputs and are, therefore, intended to interface as microcontroller reset inputs. Moreover, the combination of these two devices can be used to implement a temperature window alarm by wire-ORing the outputs and using an external pull-up resistor (see Figure 5-1).

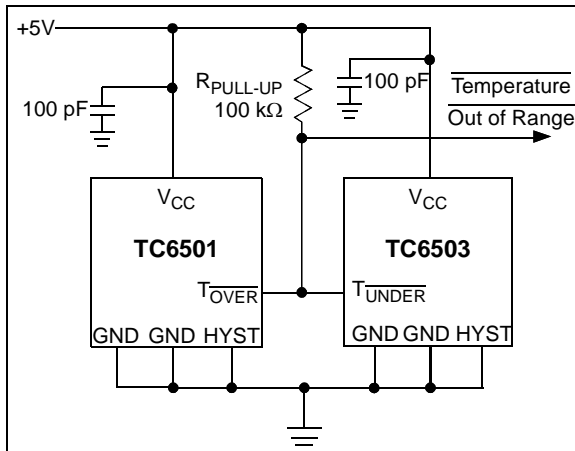

FIGURE 5-1: Over and Under Temperature Alarm.

The TC6502 can be used to control a DC fan. The fan turns on when the sensed temperature rises above the factory-set threshold and remains on until the temperature falls below threshold minus the hysteresis selected. An additional fail-safe measure could be designed by using a second TC6502 with a higher temperature threshold to alert the user of an impending thermal shutdown, should the temperature continue to rise (see Figure 5-2).



FIGURE 5-2: Fan Control with Over Temperature Alert.

The TC6504, with its push-pull output, may be used in a similar fashion to turn on a heater element at cold temperatures (see Figure 5-3).



FIGURE 5-3: TC6504 As Heater Thermostat.

TC6501/2/3/4

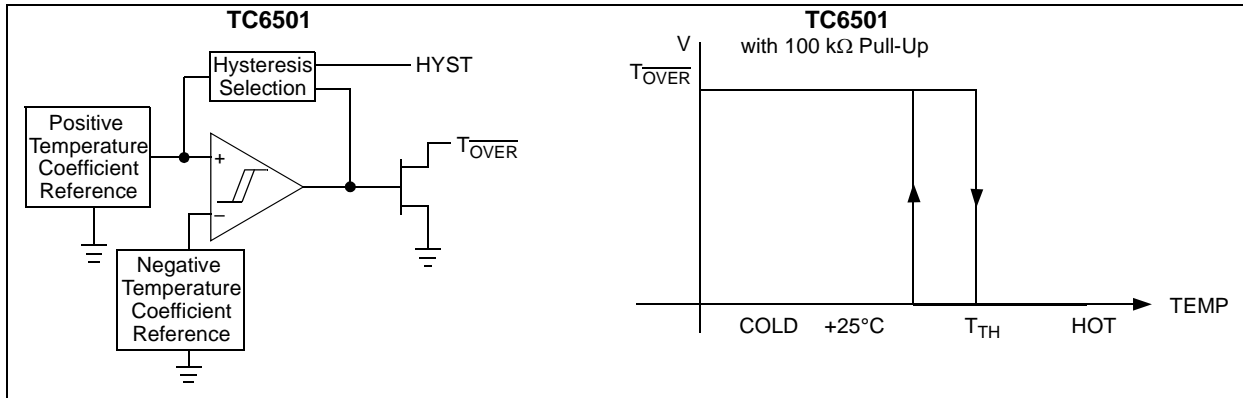

FIGURE 5-4: TC6501 Functional Block Diagram.

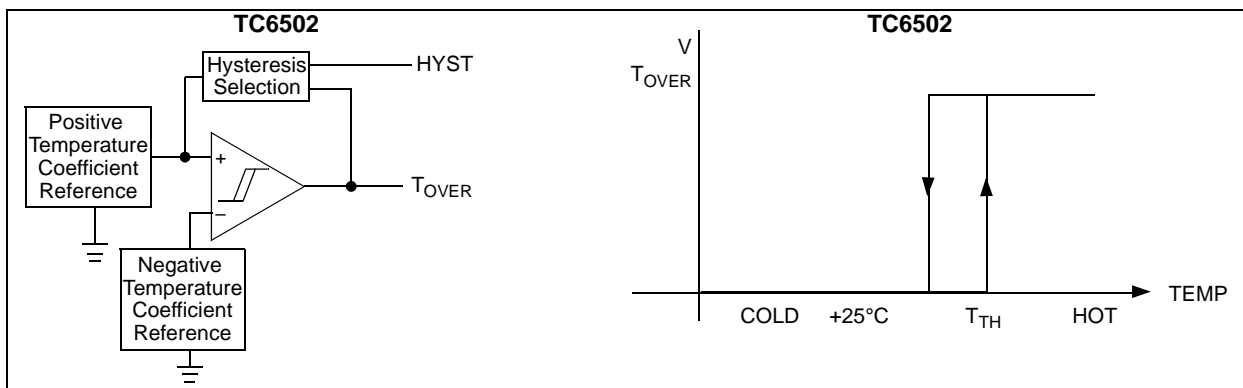

FIGURE 5-5: TC6502 Functional Block Diagram.

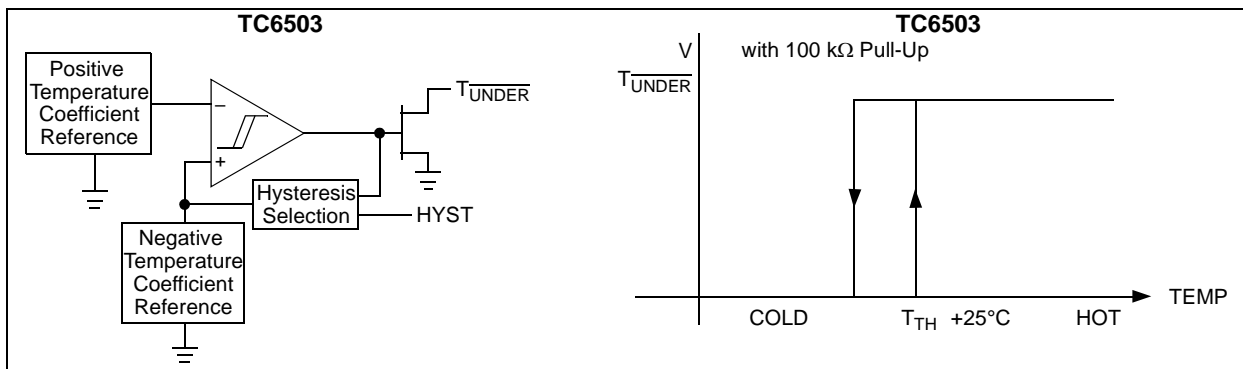

FIGURE 5-6: TC6503 Functional Block Diagram.

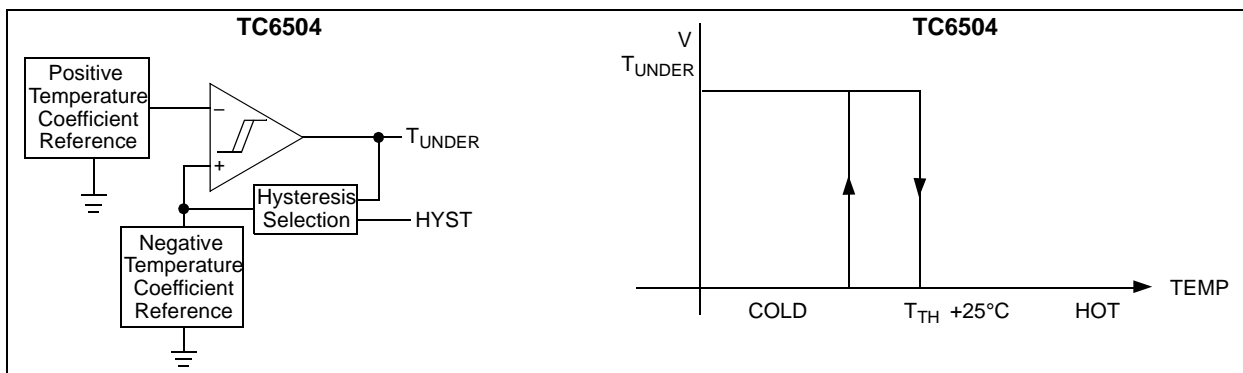

FIGURE 5-7: TC6504 Functional Block Diagram.

6.0 PACKAGING INFORMATION

6.1 Package Marking Diagram



Part Number	Marking Code	Temperature Threshold (°C)
TC6501P045VCT	HA	45
TC6501P065VCT	HC	65
TC6501P075VCT	HD	75
TC6501P095VCT	HF	95
TC6501P105VCT	HG	105
TC6501P115VCT	HH	115
TC6501P120VCT	HV	120
TC6501P125VCT	HJ	125
TC6502P045VCT	JA	45
TC6502P065VCT	JC	65
TC6502P075VCT	JD	75
TC6502P095VCT	JF	95
TC6502P115VCT	JH	115
TC6502P125VCT	JJ	125
TC6503N015VCT	KA	-15
TC6503P005VCT	KB	5
TC6504N015VCT	LA	-15
TC6504P005VCT	LB	5

Note: Please contact Microchip Technology for the availability of a particular temperature threshold not included in Table 4-1.

Legend:	XX...X	Customer-specific information
	Y	Year code (last digit of calendar year)
	YY	Year code (last 2 digits of calendar year)
	WW	Week code (week of January 1 is week '01')
	NNN	Alphanumeric traceability code
	(e3)	Pb-free JEDEC designator for Matte Tin (Sn)
	*	This package is Pb-free. The Pb-free JEDEC designator (e3) can be found on the outer packaging for this package.

Note: In the event the full Microchip part number cannot be marked on one line, it will be carried over to the next line, thus limiting the number of available characters for customer-specific information.

TC6501/2/3/4

5-Lead Plastic Small Outline Transistor (CT) (SOT-23)

Note: For the most current package drawings, please see the Microchip Packaging Specification located at <http://www.microchip.com/packaging>



Dimension Limits	Units	INCHES*			MILLIMETERS		
		MIN	NOM	MAX	MIN	NOM	MAX
Number of Pins	n		5			5	
Pitch	p		.038			0.95	
Outside lead pitch (basic)	p1		.075			1.90	
Overall Height	A	.035	.046	.057	0.90	1.18	1.45
Molded Package Thickness	A2	.035	.043	.051	0.90	1.10	1.30
Standoff §	A1	.000	.003	.006	0.00	0.08	0.15
Overall Width	E	.102	.110	.118	2.60	2.80	3.00
Molded Package Width	E1	.059	.064	.069	1.50	1.63	1.75
Overall Length	D	.110	.116	.122	2.80	2.95	3.10
Foot Length	L	.014	.018	.022	0.35	0.45	0.55
Foot Angle	φ	0	5	10	0	5	10
Lead Thickness	c	.004	.006	.008	0.09	0.15	0.20
Lead Width	B	.014	.017	.020	0.35	0.43	0.50
Mold Draft Angle Top	α	0	5	10	0	5	10
Mold Draft Angle Bottom	β	0	5	10	0	5	10

* Controlling Parameter

§ Significant Characteristic

Notes:

Dimensions D and E1 do not include mold flash or protrusions. Mold flash or protrusions shall not exceed .010" (0.254mm) per side.

JEDEC Equivalent: MO-178

Drawing No. C04-091

Product Tape and Reel Specification



7.0 REVISION HISTORY

Revision E (December 2012)

Added a note to the package outline drawing.

PRODUCT IDENTIFICATION SYSTEM

To order or obtain information, e.g., on pricing or delivery, refer to the factory or the listed sales office.

<u>PART NO.</u>	<u>XXXX</u>	<u>XXXXX</u>	Examples:
Device	Standard Temperature Threshold	Package	
Device:	TC6501: Ultra Small Temp Switch with Pin-Selectable Hysteresis		a) TC6501P045VCTTR: 5-Pin SOT-23A, 45°C, Open-Drain, tape and reel.
	TC6502: Ultra Small Temp Switch with Pin-Selectable Hysteresis		b) TC6501P065VCTTR: 5-Pin SOT-23A, 65°C, Open-Drain, tape and reel.
	TC6503: Ultra Small Temp Switch with Pin-Selectable Hysteresis		c) TC6501P095VCTTR: 5-Pin SOT-23A, 95°C, Open-Drain, tape and reel.
	TC6504: Ultra Small Temp Switch with Pin-Selectable Hysteresis		d) TC6501P095VCTRT: 5-Pin SOT-23A, 95°C, Open-Drain, reverse tape and reel.
			e) TC6501P125VCTRT: 5-Pin SOT-23A, 125°C, Open-Drain, reverse tape and reel.
Standard Temperature Threshold:	N015 = -15°C (TC6503, TC6504)		a) TC6502P045VCTTR 5-Pin SOT-23A, 45°C, Push-Pull, tape and reel.
	P005 = 5°C (TC6503, TC6504)		b) TC6502P065VCTTR 5-Pin SOT-23A, 65°C, Push-Pull, tape and reel.
	P045 = 45°C (TC6501, TC6502)		c) TC6502P095VCTTR: 5-Pin SOT-23A, 95°C, Push-Pull, tape and reel.
	P065 = 65°C (TC6501, TC6502)		
	P075 = 75°C (TC6501, TC6502)		a) TC6503N015VCTTR 5-Pin SOT-23A, -15°C, Open-Drain, tape and reel.
	P095 = 95°C (TC6501, TC6502)		b) TC6503P005VCTTR: 5-Pin SOT-23A, 5°C, Open-Drain, tape and reel.
	P105 = 105°C (TC6501)		
	P115 = 115°C (TC6501, TC6502)		a) TC6504N015VCTTR: 5-Pin SOT-23A, -15°C, Push-Pull, tape and reel.
	P120 = 120°C (TC6501)		b) TC6504P005VCTTR: 5-Pin SOT-23A, 5°C, Push-Pull, tape and reel.
	P125 = 125°C (TC6501, TC6502)		
Package:	VCTTR = SOT-23, 5-lead (Tape and Reel)		
	VCTRT = SOT-23, 5-lead (Reverse Tape and Reel) (Available only in 95°C and 125°C temperatures for TC6501)		

Sales and Support

Data Sheets

Products supported by a preliminary Data Sheet may have an errata sheet describing minor operational differences and recommended workarounds. To determine if an errata sheet exists for a particular device, please contact one of the following:

1. Your local Microchip sales office
2. The Microchip Worldwide Site (www.microchip.com)

Please specify which device, revision of silicon and Data Sheet (include Literature #) you are using.

Customer Notification System

Register on our web site (www.microchip.com/cn) to receive the most current information on our products.

TC6501/2/3/4

NOTES:

Note the following details of the code protection feature on Microchip devices:

- Microchip products meet the specification contained in their particular Microchip Data Sheet.
- Microchip believes that its family of products is one of the most secure families of its kind on the market today, when used in the intended manner and under normal conditions.
- There are dishonest and possibly illegal methods used to breach the code protection feature. All of these methods, to our knowledge, require using the Microchip products in a manner outside the operating specifications contained in Microchip's Data Sheets. Most likely, the person doing so is engaged in theft of intellectual property.
- Microchip is willing to work with the customer who is concerned about the integrity of their code.
- Neither Microchip nor any other semiconductor manufacturer can guarantee the security of their code. Code protection does not mean that we are guaranteeing the product as “unbreakable.”

Code protection is constantly evolving. We at Microchip are committed to continuously improving the code protection features of our products. Attempts to break Microchip's code protection feature may be a violation of the Digital Millennium Copyright Act. If such acts allow unauthorized access to your software or other copyrighted work, you may have a right to sue for relief under that Act.

Information contained in this publication regarding device applications and the like is provided only for your convenience and may be superseded by updates. It is your responsibility to ensure that your application meets with your specifications. MICROCHIP MAKES NO REPRESENTATIONS OR WARRANTIES OF ANY KIND WHETHER EXPRESS OR IMPLIED, WRITTEN OR ORAL, STATUTORY OR OTHERWISE, RELATED TO THE INFORMATION, INCLUDING BUT NOT LIMITED TO ITS CONDITION, QUALITY, PERFORMANCE, MERCHANTABILITY OR FITNESS FOR PURPOSE. Microchip disclaims all liability arising from this information and its use. Use of Microchip devices in life support and/or safety applications is entirely at the buyer's risk, and the buyer agrees to defend, indemnify and hold harmless Microchip from any and all damages, claims, suits, or expenses resulting from such use. No licenses are conveyed, implicitly or otherwise, under any Microchip intellectual property rights.

Trademarks

The Microchip name and logo, the Microchip logo, dsPIC, FlashFlex, KEELOQ, KEELOQ logo, MPLAB, PIC, PICmicro, PICSTART, PIC³² logo, rPIC, SST, SST Logo, SuperFlash and UNI/O are registered trademarks of Microchip Technology Incorporated in the U.S.A. and other countries.

FilterLab, Hampshire, HI-TECH C, Linear Active Thermistor, MTP, SEEVAL and The Embedded Control Solutions Company are registered trademarks of Microchip Technology Incorporated in the U.S.A.

Silicon Storage Technology is a registered trademark of Microchip Technology Inc. in other countries.

Analog-for-the-Digital Age, Application Maestro, BodyCom, chipKIT, chipKIT logo, CodeGuard, dsPICDEM, dsPICDEM.net, dsPICworks, dsSPEAK, ECAN, ECONOMONITOR, FanSense, HI-TIDE, In-Circuit Serial Programming, ICSP, Mindi, MiWi, MPASM, MPF, MPLAB Certified logo, MPLIB, MPLINK, mTouch, Omniclient Code Generation, PICC, PICC-18, PICDEM, PICDEM.net, PICkit, PICtail, REAL ICE, rLAB, Select Mode, SQI, Serial Quad I/O, Total Endurance, TSHARC, UniWinDriver, WiperLock, ZENA and Z-Scale are trademarks of Microchip Technology Incorporated in the U.S.A. and other countries.

SQTP is a service mark of Microchip Technology Incorporated in the U.S.A.

GestIC and ULPP are registered trademarks of Microchip Technology Germany II GmbH & Co. & KG, a subsidiary of Microchip Technology Inc., in other countries.

All other trademarks mentioned herein are property of their respective companies.

© 2002-2012, Microchip Technology Incorporated, Printed in the U.S.A., All Rights Reserved.

 Printed on recycled paper.

ISBN: 9781620768327

QUALITY MANAGEMENT SYSTEM
CERTIFIED BY DNV
== ISO/TS 16949 ==

Microchip received ISO/TS-16949:2009 certification for its worldwide headquarters, design and wafer fabrication facilities in Chandler and Tempe, Arizona; Gresham, Oregon and design centers in California and India. The Company's quality system processes and procedures are for its PIC[®] MCUs and dsPIC[®] DSCs, KEELOQ[®] code hopping devices, Serial EEPROMs, microperipherals, nonvolatile memory and analog products. In addition, Microchip's quality system for the design and manufacture of development systems is ISO 9001:2000 certified.



MICROCHIP

Worldwide Sales and Service

AMERICAS

Corporate Office
2355 West Chandler Blvd.
Chandler, AZ 85224-6199
Tel: 480-792-7200
Fax: 480-792-7277
Technical Support:
<http://www.microchip.com/support>
Web Address:
www.microchip.com

Atlanta
Duluth, GA
Tel: 678-957-9614
Fax: 678-957-1455

Boston
Westborough, MA
Tel: 774-760-0087
Fax: 774-760-0088

Chicago
Itasca, IL
Tel: 630-285-0071
Fax: 630-285-0075

Cleveland
Independence, OH
Tel: 216-447-0464
Fax: 216-447-0643

Dallas
Addison, TX
Tel: 972-818-7423
Fax: 972-818-2924

Detroit
Farmington Hills, MI
Tel: 248-538-2250
Fax: 248-538-2260

Indianapolis
Noblesville, IN
Tel: 317-773-8323
Fax: 317-773-5453

Los Angeles
Mission Viejo, CA
Tel: 949-462-9523
Fax: 949-462-9608

Santa Clara
Santa Clara, CA
Tel: 408-961-6444
Fax: 408-961-6445

Toronto
Mississauga, Ontario,
Canada
Tel: 905-673-0699
Fax: 905-673-6509

ASIA/PACIFIC

Asia Pacific Office
Suites 3707-14, 37th Floor
Tower 6, The Gateway
Harbour City, Kowloon
Hong Kong
Tel: 852-2401-1200
Fax: 852-2401-3431

Australia - Sydney
Tel: 61-2-9868-6733
Fax: 61-2-9868-6755

China - Beijing
Tel: 86-10-8569-7000
Fax: 86-10-8528-2104

China - Chengdu
Tel: 86-28-8665-5511
Fax: 86-28-8665-7889

China - Chongqing
Tel: 86-23-8980-9588
Fax: 86-23-8980-9500

China - Hangzhou
Tel: 86-571-2819-3187
Fax: 86-571-2819-3189

China - Hong Kong SAR
Tel: 852-2943-5100
Fax: 852-2401-3431

China - Nanjing
Tel: 86-25-8473-2460
Fax: 86-25-8473-2470

China - Qingdao
Tel: 86-532-8502-7355
Fax: 86-532-8502-7205

China - Shanghai
Tel: 86-21-5407-5533
Fax: 86-21-5407-5066

China - Shenyang
Tel: 86-24-2334-2829
Fax: 86-24-2334-2393

China - Shenzhen
Tel: 86-755-8864-2200
Fax: 86-755-8203-1760

China - Wuhan
Tel: 86-27-5980-5300
Fax: 86-27-5980-5118

China - Xian
Tel: 86-29-8833-7252
Fax: 86-29-8833-7256

China - Xiamen
Tel: 86-592-2388138
Fax: 86-592-2388130

China - Zhuhai
Tel: 86-756-3210040
Fax: 86-756-3210049

ASIA/PACIFIC

India - Bangalore
Tel: 91-80-3090-4444
Fax: 91-80-3090-4123

India - New Delhi
Tel: 91-11-4160-8631
Fax: 91-11-4160-8632

India - Pune
Tel: 91-20-2566-1512
Fax: 91-20-2566-1513

Japan - Osaka
Tel: 81-6-6152-7160
Fax: 81-6-6152-9310

Japan - Tokyo
Tel: 81-3-6880-3770
Fax: 81-3-6880-3771

Korea - Daegu
Tel: 82-53-744-4301
Fax: 82-53-744-4302

Korea - Seoul
Tel: 82-2-554-7200
Fax: 82-2-558-5932 or
82-2-558-5934

Malaysia - Kuala Lumpur
Tel: 60-3-6201-9857
Fax: 60-3-6201-9859

Malaysia - Penang
Tel: 60-4-227-8870
Fax: 60-4-227-4068

Philippines - Manila
Tel: 63-2-634-9065
Fax: 63-2-634-9069

Singapore
Tel: 65-6334-8870
Fax: 65-6334-8850

Taiwan - Hsin Chu
Tel: 886-3-5778-366
Fax: 886-3-5770-955

Taiwan - Kaohsiung
Tel: 886-7-213-7828
Fax: 886-7-330-9305

Taiwan - Taipei
Tel: 886-2-2508-8600
Fax: 886-2-2508-0102

Thailand - Bangkok
Tel: 66-2-694-1351
Fax: 66-2-694-1350

EUROPE

Austria - Wels
Tel: 43-7242-2244-39
Fax: 43-7242-2244-393

Denmark - Copenhagen
Tel: 45-4450-2828
Fax: 45-4485-2829

France - Paris
Tel: 33-1-69-53-63-20
Fax: 33-1-69-30-90-79

Germany - Munich
Tel: 49-89-627-144-0
Fax: 49-89-627-144-44

Italy - Milan
Tel: 39-0331-742611
Fax: 39-0331-466781

Netherlands - Drunen
Tel: 31-416-690399
Fax: 31-416-690340

Spain - Madrid
Tel: 34-91-708-08-90
Fax: 34-91-708-08-91

UK - Wokingham
Tel: 44-118-921-5869
Fax: 44-118-921-5820

11/29/12



Компания «ЭлектроПласт» предлагает заключение долгосрочных отношений при поставках импортных электронных компонентов на взаимовыгодных условиях!

Наши преимущества:

- Оперативные поставки широкого спектра электронных компонентов отечественного и импортного производства напрямую от производителей и с крупнейших мировых складов;
- Поставка более 17-ти миллионов наименований электронных компонентов;
- Поставка сложных, дефицитных, либо снятых с производства позиций;
- Оперативные сроки поставки под заказ (от 5 рабочих дней);
- Экспресс доставка в любую точку России;
- Техническая поддержка проекта, помощь в подборе аналогов, поставка прототипов;
- Система менеджмента качества сертифицирована по Международному стандарту ISO 9001;
- Лицензия ФСБ на осуществление работ с использованием сведений, составляющих государственную тайну;
- Поставка специализированных компонентов (Xilinx, Altera, Analog Devices, Intersil, Interpoint, Microsemi, Aeroflex, Peregrine, Syfer, Eurofarad, Texas Instrument, Miteq, Cobham, E2V, MA-COM, Hittite, Mini-Circuits, General Dynamics и др.);

Помимо этого, одним из направлений компании «ЭлектроПласт» является направление «Источники питания». Мы предлагаем Вам помощь Конструкторского отдела:

- Подбор оптимального решения, техническое обоснование при выборе компонента;
- Подбор аналогов;
- Консультации по применению компонента;
- Поставка образцов и прототипов;
- Техническая поддержка проекта;
- Защита от снятия компонента с производства.



Как с нами связаться

Телефон: 8 (812) 309 58 32 (многоканальный)

Факс: 8 (812) 320-02-42

Электронная почта: org@eplast1.ru

Адрес: 198099, г. Санкт-Петербург, ул. Калинина, дом 2, корпус 4, литера А.