

EMRA41T2H-20.000M TR

[Click part number to visit Part Number Details page](#)

REGULATORY COMPLIANCE (Data Sheet downloaded on Jun 20, 2020)

[Click badges to download compliance docs](#)

Regulatory Compliance standards are subject to updates by governing bodies. Click the badges to download the latest compliance docs for this part number directly from Ecliptek.



ITEM DESCRIPTION

MEMS Clock Oscillators LVCMOS (CMOS) 1.8Vdc 4 Pad 2.0mm x 2.5mm Plastic Surface Mount (SMD) 20.000MHz \pm 50ppm over -40°C to +125°C

ELECTRICAL SPECIFICATIONS

Nominal Frequency	20.000MHz
Frequency Tolerance/Stability	\pm 50ppm Maximum over -40°C to +125°C (Inclusive of all conditions: Calibration Tolerance at 25°C, Frequency Stability over the Operating Temperature Range, Supply Voltage Change, and Output Load Change)
Aging at 25°C	\pm 1.5ppm Maximum First Year
Supply Voltage	1.8Vdc \pm 10%
Input Current	4.5mA Maximum (No Load)
Output Voltage Logic High (Voh)	90% of Vdd Minimum (IOH = -2mA)
Output Voltage Logic Low (Vol)	10% of Vdd Maximum (IOL = +2mA)
Rise/Fall Time	1.5nSec Typical, 3.5nSec Maximum (Measured from 20% to 80% of waveform)
Duty Cycle	50 \pm 5(%) (Measured at 50% of waveform)
Load Drive Capability	15pF Maximum
Output Logic Type	CMOS
Output Control Function	Tri-State (Disabled Output: High Impedance)
Output Control Input Voltage Logic High (Vih)	70% of Vdd Minimum or No Connect to Enable Output
Output Control Input Voltage Logic Low (Vil)	30% of Vdd Maximum to Disable Output
Tri-State Output Enable Time	150nSec Maximum
Tri-State Output Disable Time	150nSec Maximum
Period Jitter (RMS)	2pSec Typical, 5pSec Maximum
RMS Phase Jitter (Fj = 900kHz to 7.5MHz; Random)	0.5pSec Typical, 1pSec Maximum
RMS Phase Jitter (Fj = 12kHz to 20MHz; Random)	1.5pSec Typical, 3pSec Maximum
Start Up Time	5mSec Maximum
Storage Temperature Range	-65°C to +150°C

ENVIRONMENTAL & MECHANICAL SPECIFICATIONS

ESD Susceptibility	JESD22-A114, HBM, 2000V
Flammability	UL94-V0
Mechanical Shock	MIL-STD-883, Method 2002, Condition E, 10,000G
Moisture Sensitivity	J-STD-020, MSL 1
Solderability	MIL-STD-883, Method 2003 (Four I/O Pads on bottom of package only)
Temperature Cycling	JESD22-A104, Condition B
Vibration	MIL-STD-883, Method 2007, Condition A, 20G

EMRA41T2H-20.000M TR [Click part number to visit Part Number Details page](#)

MECHANICAL DIMENSIONS (all dimensions in millimeters)

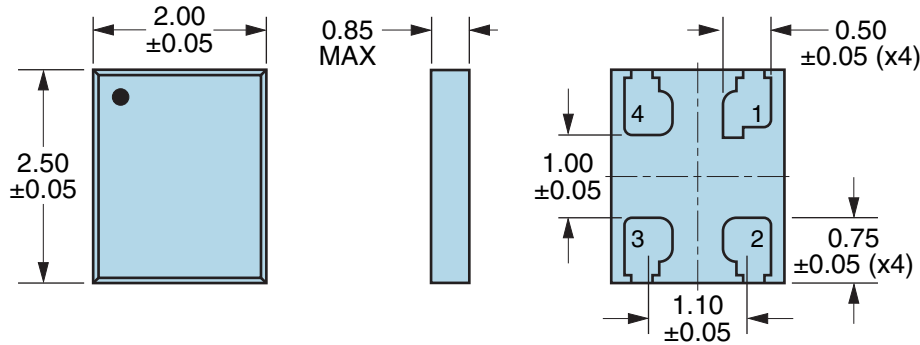

PIN	CONNECTION
1	Tri-State (High Impedance)
2	Ground
3	Output
4	Supply Voltage

LINE	MARKING
1	Ecliptek Manufacturing Identifier

Suggested Solder Pad Layout

All Dimensions in Millimeters

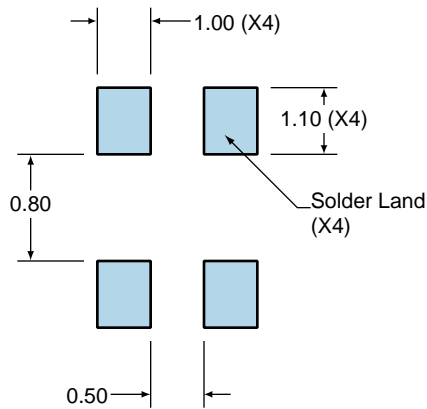

All Tolerances are ± 0.1

EMRA41T2H-20.000M TR [Click part number to visit Part Number Details page](#)

OUTPUT WAVEFORM & TIMING DIAGRAM



EMRA41T2H-20.000M TR [Click part number to visit Part Number Details page](#)

Test Circuit for CMOS Output

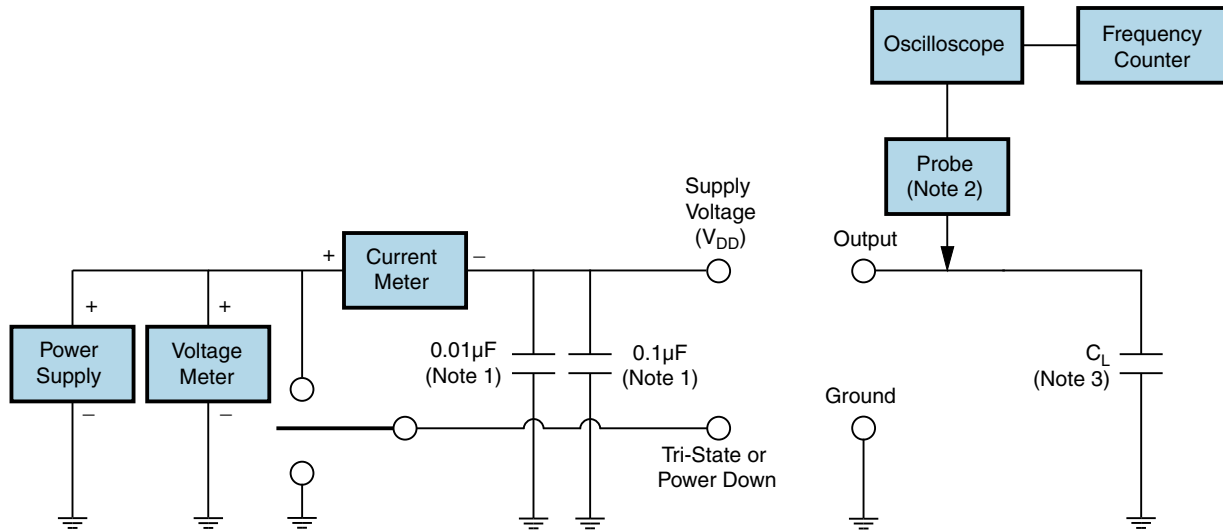

Note 1: An external 0.01µF ceramic bypass capacitor in parallel with a 0.1µF high frequency ceramic bypass capacitor close (less than 2mm) to the package ground and supply voltage pin is required.

Note 2: A low input capacitance (<12pF), 10X Attenuation Factor, High Impedance (>10Mohms), and High bandwidth (>300MHz) passive probe is recommended.

Note 3: Capacitance value CL includes sum of all probe and fixture capacitance. See applicable specification sheet for 'Load Drive Capability'.

EMRA41T2H-20.000M TR

Tape & Reel Dimensions

Quantity Per Reel: 1,000 units

All Dimensions in Millimeters

Compliant to EIA-481

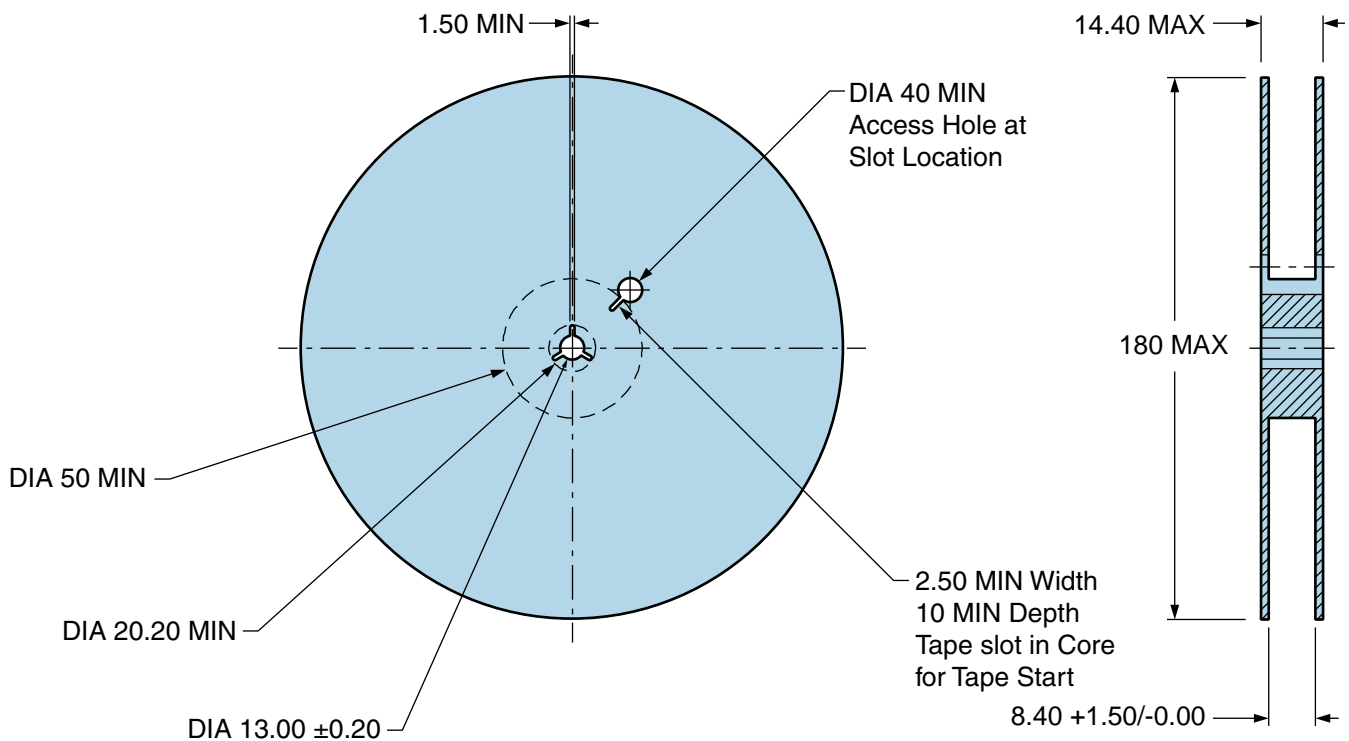
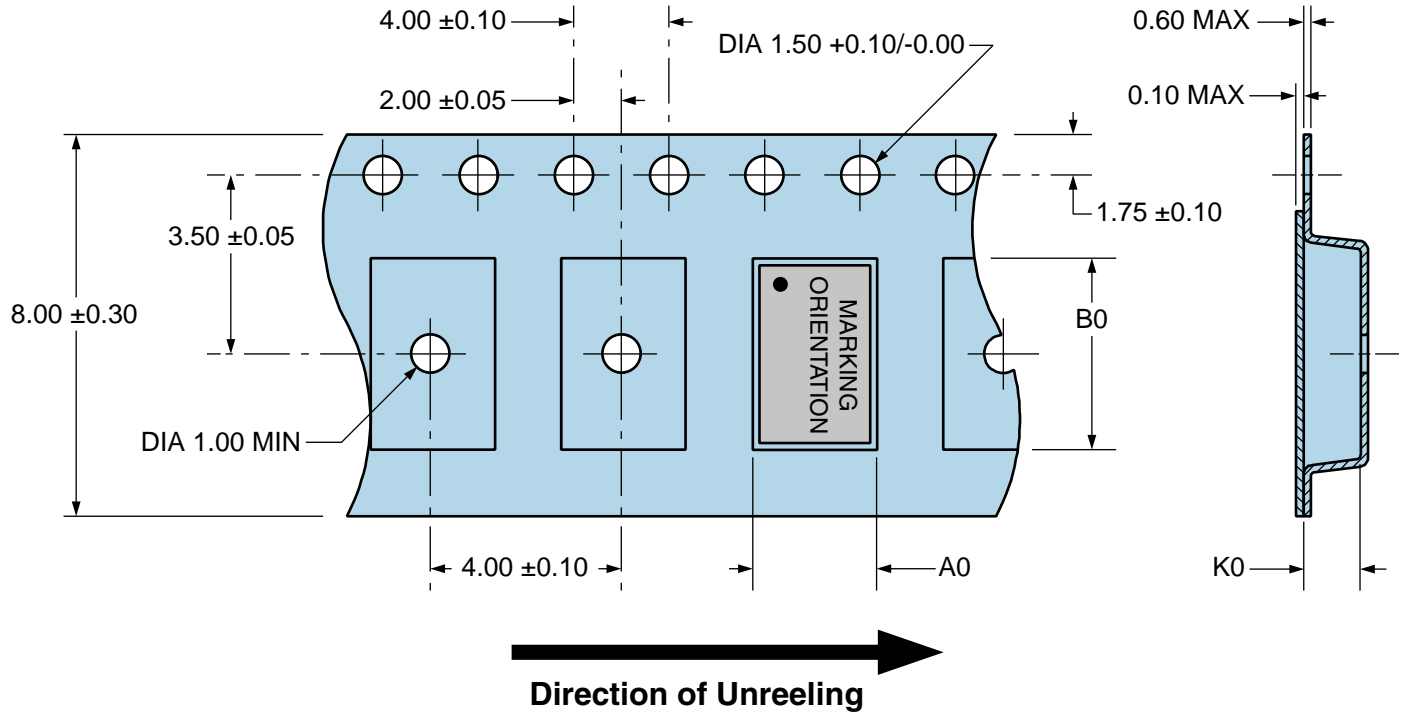

EMRA41T2H-20.000M TR

[Click part number to visit Part Number Details page](#)

Recommended Solder Reflow Methods

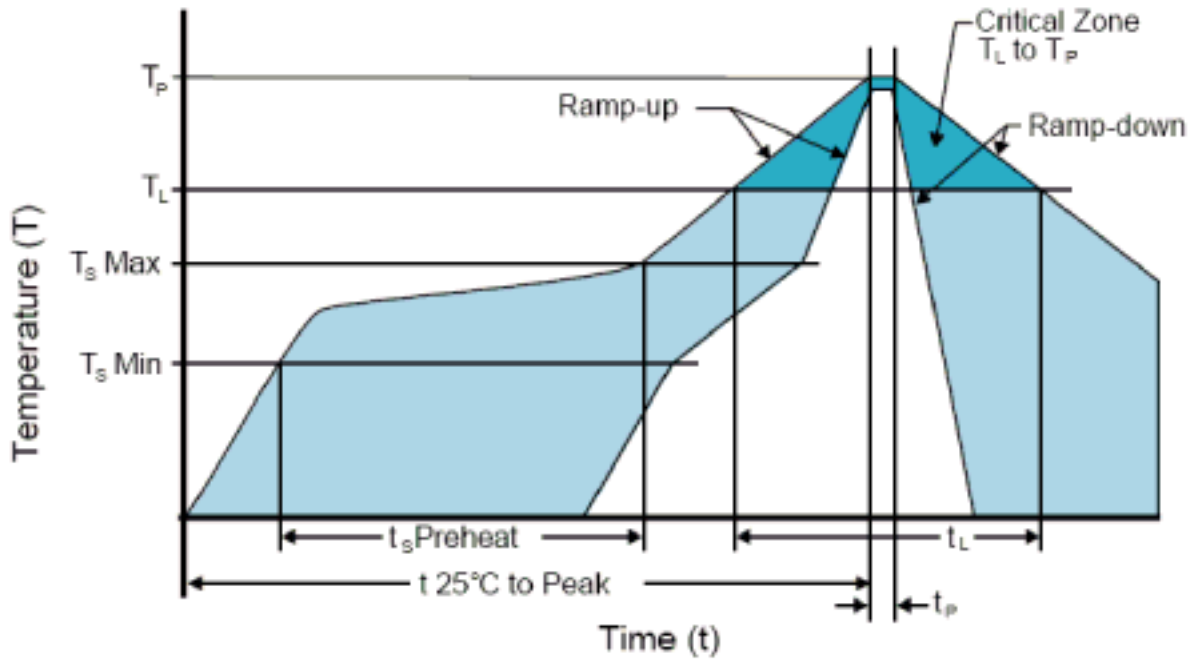

High Temperature Infrared/Convection

T_s MAX to T_L (Ramp-up Rate)	3°C/Second Maximum
Preheat	
- Temperature Minimum (T_s MIN)	150°C
- Temperature Typical (T_s TYP)	175°C
- Temperature Maximum (T_s MAX)	200°C
- Time (t_s MIN)	60 - 180 Seconds
Ramp-up Rate (T_L to T_P)	3°C/Second Maximum
Time Maintained Above:	
- Temperature (T_L)	217°C
- Time (t_L)	60 - 150 Seconds
Peak Temperature (T_P)	260°C Maximum for 10 Seconds Maximum
Target Peak Temperature (T_P Target)	250°C +0/-5°C
Time within 5°C of actual peak (t_p)	20 - 40 Seconds
Ramp-down Rate	6°C/Second Maximum
Time 25°C to Peak Temperature (t)	8 Minutes Maximum
Moisture Sensitivity Level	Level 1
Additional Notes	Temperature shown are applied to body of device.

EMRA41T2H-20.000M TR [Click part number to visit Part Number Details page](#)

Recommended Solder Reflow Methods

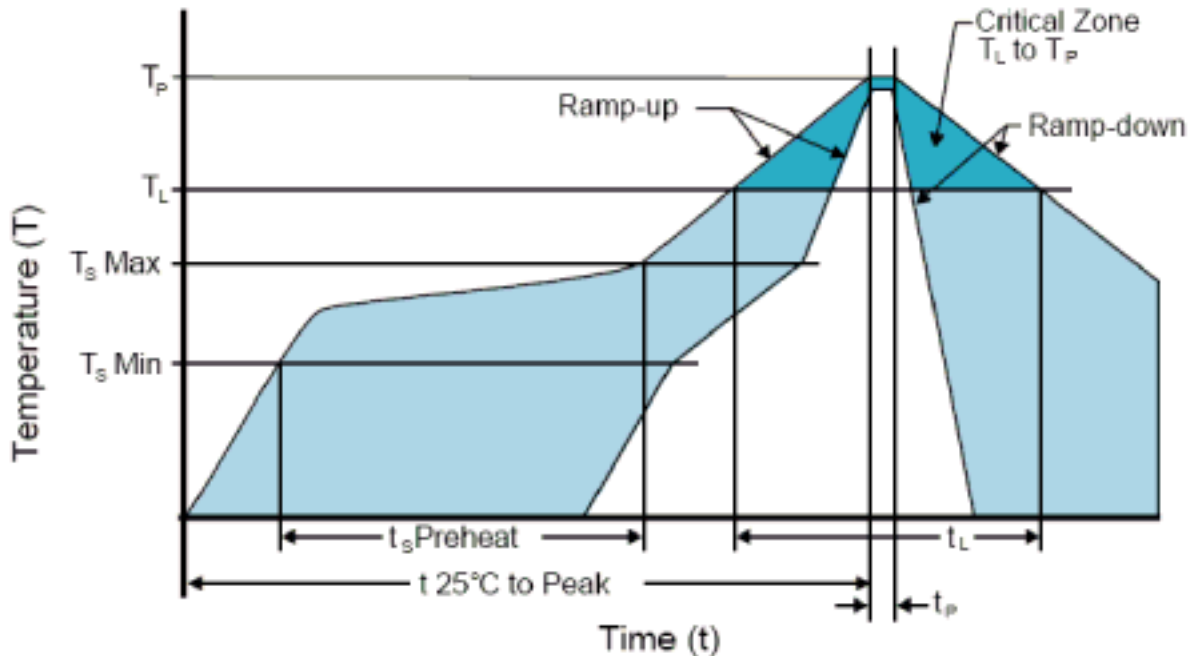

Low Temperature Infrared/Convection 240°C

Ts MAX to TL (Ramp-up Rate)	5°C/Second Maximum
Preheat	
- Temperature Minimum (Ts MIN)	N/A
- Temperature Typical (Ts TYP)	150°C
- Temperature Maximum (Ts MAX)	N/A
- Time (ts MIN)	60 - 120 Seconds
Ramp-up Rate (TL to TP)	5°C/Second Maximum
Time Maintained Above:	
- Temperature (TL)	150°C
- Time (tL)	200 Seconds Maximum
Peak Temperature (TP)	240°C Maximum
Target Peak Temperature (TP Target)	240°C Maximum 2 Times / 230°C Maximum 1 Time
Time within 5°C of actual peak (tp)	10 Seconds Maximum 2 Times / 80 Seconds Maximum 1 Time
Ramp-down Rate	5°C/Second Maximum
Time 25°C to Peak Temperature (t)	N/A
Moisture Sensitivity Level	Level 1
Additional Notes	Temperature shown are applied to body of device.

Low Temperature Manual Soldering

185°C Maximum for 10 Seconds Maximum, 2 times Maximum. (Temperature shown are applied to body of device.)

High Temperature Manual Soldering

260°C Maximum for 5 Seconds Maximum, 2 times Maximum. (Temperature shown are applied to body of device.)

Mouser Electronics

Authorized Distributor

Click to View Pricing, Inventory, Delivery & Lifecycle Information:

[Ecliptek:](#)

[EMRA41T2H-20.000M TR](#)



Компания «ЭлектроПласт» предлагает заключение долгосрочных отношений при поставках импортных электронных компонентов на взаимовыгодных условиях!

Наши преимущества:

- Оперативные поставки широкого спектра электронных компонентов отечественного и импортного производства напрямую от производителей и с крупнейших мировых складов;
- Поставка более 17-ти миллионов наименований электронных компонентов;
- Поставка сложных, дефицитных, либо снятых с производства позиций;
- Оперативные сроки поставки под заказ (от 5 рабочих дней);
- Экспресс доставка в любую точку России;
- Техническая поддержка проекта, помощь в подборе аналогов, поставка прототипов;
- Система менеджмента качества сертифицирована по Международному стандарту ISO 9001;
- Лицензия ФСБ на осуществление работ с использованием сведений, составляющих государственную тайну;
- Поставка специализированных компонентов (Xilinx, Altera, Analog Devices, Intersil, Interpoint, Microsemi, Aeroflex, Peregrine, Syfer, Eurofarad, Texas Instrument, Miteq, Cobham, E2V, MA-COM, Hittite, Mini-Circuits, General Dynamics и др.);

Помимо этого, одним из направлений компании «ЭлектроПласт» является направление «Источники питания». Мы предлагаем Вам помощь Конструкторского отдела:

- Подбор оптимального решения, техническое обоснование при выборе компонента;
- Подбор аналогов;
- Консультации по применению компонента;
- Поставка образцов и прототипов;
- Техническая поддержка проекта;
- Защита от снятия компонента с производства.



Как с нами связаться

Телефон: 8 (812) 309 58 32 (многоканальный)

Факс: 8 (812) 320-02-42

Электронная почта: org@eplast1.ru

Адрес: 198099, г. Санкт-Петербург, ул. Калинина, дом 2, корпус 4, литера А.